

# SiT8008

## Low Power Programmable Oscillator



### Features

- Any frequency between 1 MHz and 110 MHz accurate to 6 decimal places
- Operating temperature from -40°C to 85°C. Refer to [SiT8918](#) and [SiT8920](#) for high temperature options
- Excellent total frequency stability as low as  $\pm 20$  PPM
- Low power consumption of 3.6 mA typical
- Programmable drive strength for improved jitter, system EMI reduction, or driving large capacitive loads
- LVC MOS/HCMOS compatible output
- Industry-standard packages: 2.0 x 1.6, 2.5 x 2.0, 3.2 x 2.5, 5.0 x 3.2, 7.0 x 5.0 mm x mm
- Instant samples with [Time Machine II](#) and [field programmable oscillators](#)
- Pb-free, RoHS and REACH compliant

### Applications

- Ideal for DSC, DVC, DVR, IP CAM, Tablets, e-Books, SSD, GPON, EPON, etc
- Ideal for high-speed serial protocols such as: USB, SATA, SAS, Firewire, 100M / 1G / 10G Ethernet, etc.



### Electrical Characteristics<sup>[1]</sup>

| Parameter and Conditions                      | Symbol | Min. | Typ. | Max. | Unit       | Condition   |
|---|--------|------|------|------|------------|---|
| <b>Frequency Range</b>                        |        |      |      |      |            |   |
| Output Frequency Range                        | f      | 1    | –    | 110  | MHz        |   |
| <b>Frequency Stability and Aging</b>          |        |      |      |      |            |   |
| Frequency Stability                           | F_stab | -20  | –    | +20  | PPM        | Inclusive of Initial tolerance at 25°C, 1st year aging at 25°C, and variations over operating temperature, rated power supply voltage and load (15 pF $\pm$ 10%). |
|   |        | -25  | –    | +25  | PPM        |   |
|   |        | -50  | –    | +50  | PPM        |   |
| <b>Operating Temperature Range</b>            |        |      |      |      |            |   |
| Operating Temperature Range                   | T_use  | -20  | –    | +70  | °C         | Extended Commercial   |
|   |        | -40  | –    | +85  | °C         | Industrial  |
| <b>Supply Voltage and Current Consumption</b> |        |      |      |      |            |   |
| Supply Voltage                                | Vdd    | 1.62 | 1.8  | 1.98 | V          | Contact <a href="#">SiTime</a> for 1.5V support   |
|   |        | 2.25 | 2.5  | 2.75 | V          |   |
|   |        | 2.52 | 2.8  | 3.08 | V          |   |
|   |        | 2.7  | 3.0  | 3.3  | V          |   |
|   |        | 2.97 | 3.3  | 3.63 | V          |   |
|   |        | 2.25 | –    | 3.63 | V          |   |
| Current Consumption                           | Idd    | –    | 3.8  | 4.5  | mA         | No load condition, f = 20 MHz, Vdd = 2.8V, 3.0V, 3.3V, 2.25V to 3.63V   |
|   |        | –    | 3.6  | 4.2  | mA         | No load condition, f = 20 MHz, Vdd = 2.5V   |
|   |        | –    | 3.4  | 3.9  | mA         | No load condition, f = 20 MHz, Vdd = 1.8V   |
| OE Disable Current                            | I_OD   | –    | –    | 4    | mA         | Vdd = 2.5V to 3.3V, OE = GND, output is Weakly Pulled Down  |
|   |        | –    | –    | 3.8  | mA         | Vdd = 1.8V, OE = GND, output is Weakly Pulled Down  |
| Standby Current                               | I_std  | –    | 2.6  | 4.3  | $\mu$ A    | $\overline{ST}$ = GND, Vdd = 2.8V to 3.3V, Output is Weakly Pulled Down   |
|   |        | –    | 1.4  | 2.5  | $\mu$ A    | $\overline{ST}$ = GND, Vdd = 2.5V, Output is Weakly Pulled Down   |
|   |        | –    | 0.6  | 1.3  | $\mu$ A    | $\overline{ST}$ = GND, Vdd = 1.8V, Output is Weakly Pulled Down   |
| <b>LVC MOS Output Characteristics</b>         |        |      |      |      |            |   |
| Duty Cycle                                    | DC     | 45   | –    | 55   | %          | All Vdds  |
| Rise/Fall Time                                | Tr, Tf | –    | 1    | 2    | ns         | Vdd = 2.5V, 2.8V, 3.0V or 3.3V, 20% - 80%   |
|   |        | –    | 1.3  | 2.5  | ns         | Vdd = 1.8V, 20% - 80%   |
|   |        | –    | –    | 2    | ns         | Vdd = 2.25V - 3.63V, 20% - 80%  |
| Output High Voltage                           | VOH    | 90%  | –    | –    | Vdd        | IOH = -4 mA (Vdd = 3.0V or 3.3V)<br>IOH = -3 mA (Vdd = 2.8V and Vdd = 2.5V)<br>IOH = -2 mA (Vdd = 1.8V)   |
| Output Low Voltage                            | VOL    | –    | –    | 10%  | Vdd        | IOL = 4 mA (Vdd = 3.0V or 3.3V)<br>IOL = 3 mA (Vdd = 2.8V and Vdd = 2.5V)<br>IOL = 2 mA (Vdd = 1.8V)  |
| <b>Input Characteristics</b>                  |        |      |      |      |            |   |
| Input High Voltage                            | VIH    | 70%  | –    | –    | Vdd        | Pin 1, OE or $\overline{ST}$  |
| Input Low Voltage                             | VIL    | –    | –    | 30%  | Vdd        | Pin 1, OE or $\overline{ST}$  |
| Input Pull-up Impedance                       | Z_in   | –    | 87   | 100  | k $\Omega$ | Pin 1, OE logic high or logic low, or $\overline{ST}$ logic high  |
|   |        | 2    | –    | –    | M $\Omega$ | Pin 1, $\overline{ST}$ logic low  |

**Note:**

1. All electrical specifications in the above table are specified with 15 pF output load at default drive strength and for all Vdd(s) unless otherwise stated.

### Electrical Characteristics<sup>[1]</sup> (continued)

| Parameter and Conditions         | Symbol   | Min. | Typ. | Max. | Unit | Condition  |
|----------------------------------|----------|------|------|------|------|--|
| <b>Startup and Resume Timing</b> |          |      |      |      |      |  |
| Startup Time                     | T_start  | –    | –    | 5    | ms   | Measured from the time Vdd reaches its rated minimum value     |
| Enable/Disable Time              | T_oe     | –    | –    | 130  | ns   | f = 110 MHz. For other frequencies, T_oe = 100 ns + 3 * cycles |
| Resume Time                      | T_resume | –    | –    | 5    | ms   | Measured from the time ST pin crosses 50% threshold            |
| <b>Jitter</b>                    |          |      |      |      |      |  |
| RMS Period Jitter                | T_jitt   | –    | 1.76 | 3    | ps   | f = 75 MHz, Vdd = 2.5V, 2.8V, 3.0V or 3.3V                     |
|                                  |          | –    | 1.78 | 3    | ps   | f = 75 MHz, Vdd = 1.8V   |
| RMS Phase Jitter (random)        | T_phj    | –    | 0.5  | 0.9  | ps   | f = 75 MHz, Integration bandwidth = 900 kHz to 7.5 MHz         |
|                                  |          | –    | 1.3  | 2    | ps   | f = 75 MHz, Integration bandwidth = 12 kHz to 20 MHz           |

**Note:**

1. All electrical specifications in the above table are specified with 15 pF output load and for all Vdd(s) unless otherwise stated.

### Pin Description

| Pin | Symbol | Functionality |   |
|-----|--------|---------------|---|
| 1   | OE/ST  | Output Enable | H or Open <sup>[2]</sup> : specified frequency output<br>L: output is high impedance. Only output driver is disabled.                                   |
|     |        | Standby       | H or Open <sup>[2]</sup> : specified frequency output<br>L: output is low (weak pull down). Device goes to sleep mode. Supply current reduces to I_std. |
| 2   | GND    | Power         | Electrical ground <sup>[3]</sup>  |
| 3   | OUT    | Output        | Oscillator output   |
| 4   | VDD    | Power         | Power supply voltage <sup>[3]</sup>   |

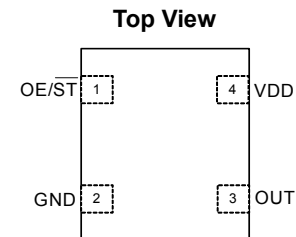

**Notes:**

2. A pull-up resistor of <10 kΩ between OE/ST pin and Vdd is recommended in high noise environment.
3. A capacitor value of 0.1 μF between Vdd and GND is recommended.

### Absolute Maximum

Attempted operation outside the absolute maximum ratings of the part may cause permanent damage to the part. Actual performance of the IC is only guaranteed within the operational specifications, not at absolute maximum ratings.

| Parameter  | Min. | Max. | Unit |
|--|------|------|------|
| Storage Temperature  | -65  | 150  | °C   |
| VDD  | -0.5 | 4    | V    |
| Electrostatic Discharge  | –    | 2000 | V    |
| Soldering Temperature (follow standard Pb free soldering guidelines) | –    | 260  | °C   |
| Junction Temperature   | –    | 150  | °C   |

### Thermal Consideration

| Package | θJA, 4 Layer Board (°C/W) | θJA, 2 Layer Board (°C/W) | θJC, Bottom (°C/W) |
|---------|---------------------------|---------------------------|--------------------|
| 7050    | 191                       | 263                       | 30                 |
| 5032    | 97                        | 199                       | 24                 |
| 3225    | 109                       | 212                       | 27                 |
| 2520    | 117                       | 222                       | 26                 |
| 2016    | 124                       | 227                       | 26                 |

### Environmental Compliance

| Parameter                  | Condition/Test Method     |
|----------------------------|---------------------------|
| Mechanical Shock           | MIL-STD-883F, Method 2002 |
| Mechanical Vibration       | MIL-STD-883F, Method 2007 |
| Temperature Cycle          | JESD22, Method A104       |
| Solderability              | MIL-STD-883F, Method 2003 |
| Moisture Sensitivity Level | MSL1 @ 260°C              |

### Test Circuit and Waveform<sup>[4]</sup>

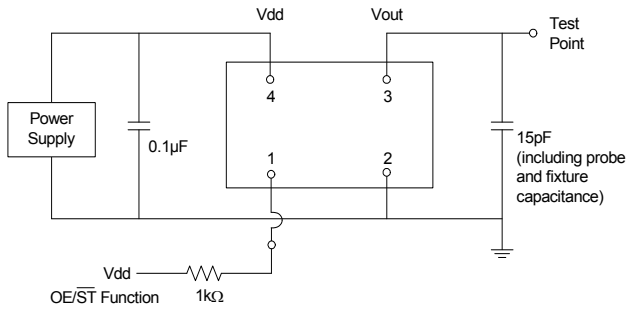

**Figure 1. Test Circuit**

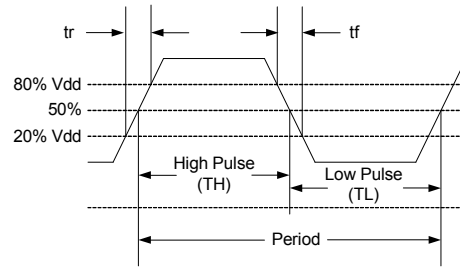
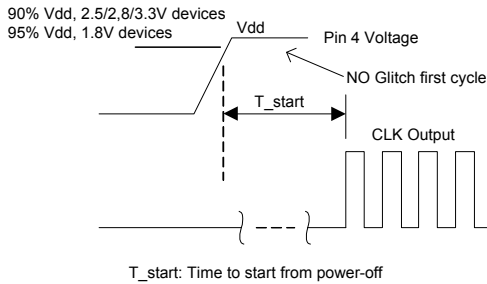

**Figure 2. Waveform**

**Note:**

4. Duty Cycle is computed as  $Duty\ Cycle = TH/Period$ .

### Timing Diagrams



**Figure 3. Startup Timing (OE/ST Mode)**

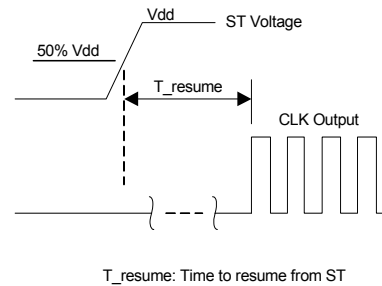

**Figure 4. Standby Resume Timing (ST Mode Only)**

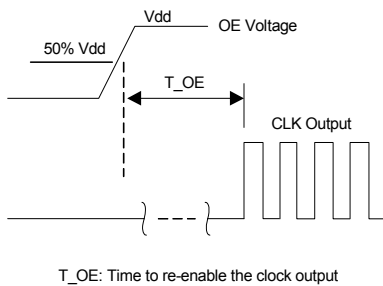

**Figure 5. OE Enable Timing (OE Mode Only)**

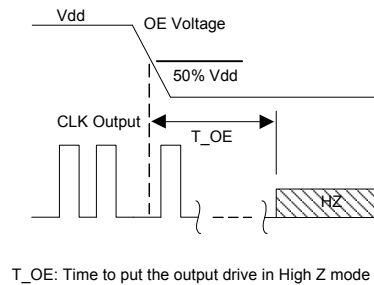

**Figure 6. OE Disable Timing (OE Mode Only)**

**Note:**

5. SiT8008 supports no runt pulses and no glitches during startup or resume.

### Performance Plots

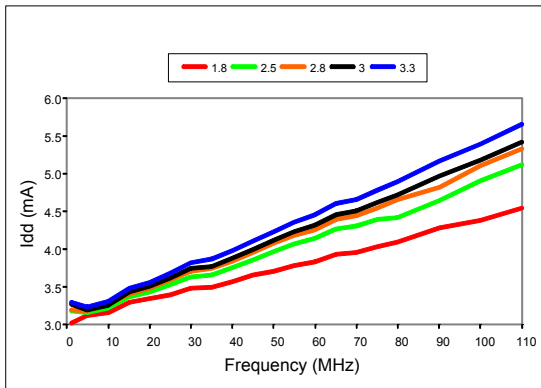

Figure 7. Idd vs Frequency

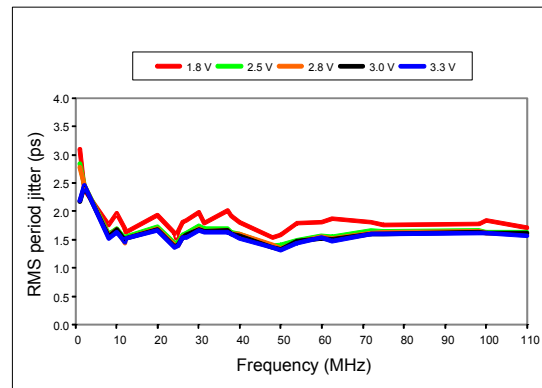

Figure 8. RMS Period Jitter vs Frequency

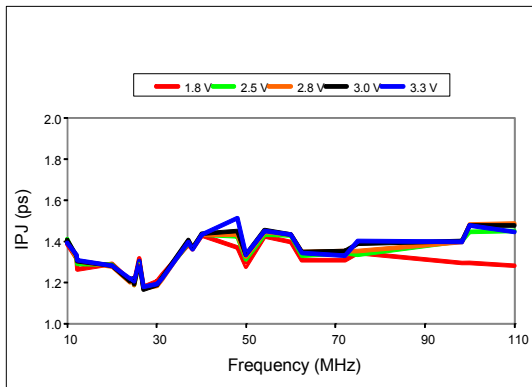

Figure 9. RMS Phase Jitter vs Frequency (12 kHz to 20 MHz Integration Bandwidth)

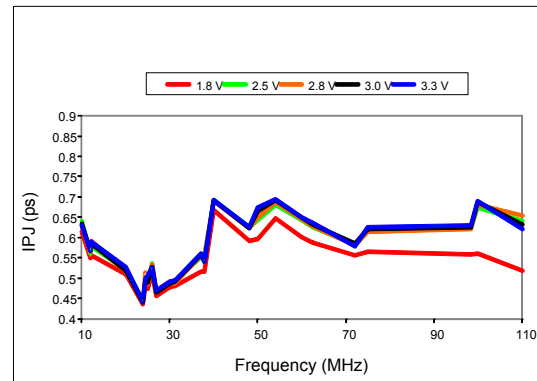

Figure 10. RMS Phase Jitter vs Frequency (900 kHz to 20 MHz Integration Bandwidth)

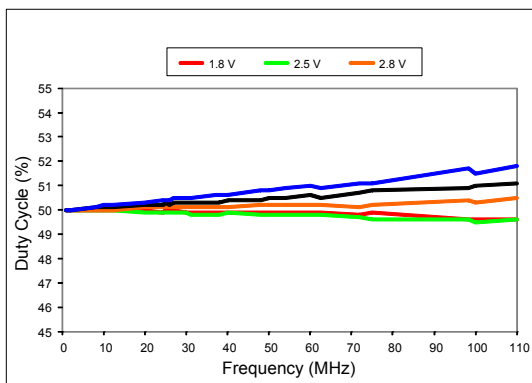

Figure 11. Duty Cycle vs Frequency

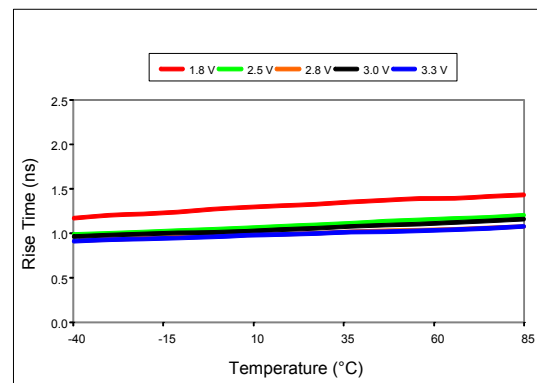

Figure 12. Rise Time vs Temperature, 20 MHz Output

**Note:**

6. All plots are measured with 15 pF load at room temperature, unless otherwise stated.

### Programmable Drive Strength

The SiT8008 includes a programmable drive strength feature to provide a simple, flexible tool to optimize the clock rise/fall time for specific applications. Benefits from the programmable drive strength feature are:

- Improves system radiated electromagnetic interference (EMI) by slowing down the clock rise/fall time
- Improves the downstream clock receiver's (RX) jitter by decreasing (speeding up) the clock rise/fall time.
- Ability to drive large capacitive loads while maintaining full swing with sharp edge rates.

For more detailed information about rise/fall time control and drive strength selection, see the SiTime Applications Note section; <http://www.sitime.com/support/application-notes>.

### EMI Reduction by Slowing Rise/Fall Time

Figure 13 shows the harmonic power reduction as the rise/fall times are increased (slowed down). The rise/fall times are expressed as a ratio of the clock period. For the ratio of 0.05, the signal is very close to a square wave. For the ratio of 0.45, the rise/fall times are very close to near-triangular waveform. These results, for example, show that the 11th clock harmonic can be reduced by 35 dB if the rise/fall edge is increased from 5% of the period to 45% of the period.

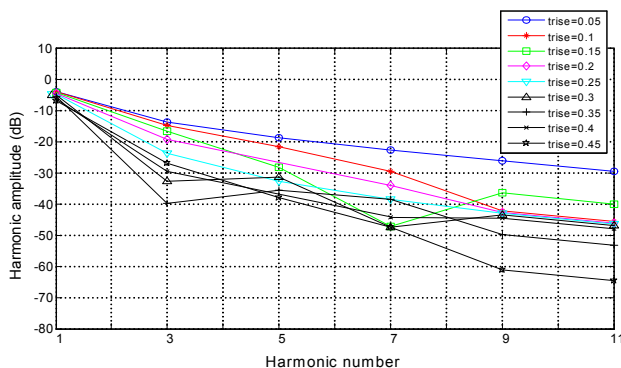

**Figure 13. Harmonic EMI reduction as a Function of Slower Rise/Fall Time**

### Jitter Reduction with Faster Rise/Fall Time

Power supply noise can be a source of jitter for the downstream chipset. One way to reduce this jitter is to increase rise/fall time (edge rate) of the input clock. Some chipsets would require faster rise/fall time in order to reduce their sensitivity to this type of jitter. The SiT8008 provides up to 3 additional high drive strength settings for very fast rise/fall time. Refer to the [Rise/Fall Time Tables](#) to determine the proper drive strength.

### High Output Load Capability

The rise/fall time of the input clock varies as a function of the actual capacitive load the clock drives. At any given drive strength, the rise/fall time becomes slower as the output load increases. As an example, for a 3.3V SiT8008 device with default drive strength setting, the typical rise/fall time is 1ns for 15 pF output load. The typical rise/fall time slows down to 2.6ns when the output load increases to 45 pF. One can

choose to speed up the rise/fall time to 1.68ns by then increasing the drive strength setting on the SiT8008.

The SiT8008 can support up to 60 pF or higher in maximum capacitive loads with up to 3 additional drive strength settings. Refer to the [Rise/Fall Time Tables](#) to determine the proper drive strength for the desired combination of output load vs. rise/fall time

### SiT8008 Drive Strength Selection

Tables 1 through 5 define the rise/fall time for a given capacitive load and supply voltage.

1. Select the table that matches the SiT8008 nominal supply voltage (1.8V, 2.5V, 2.8V, 3.0V, 3.3V).
2. Select the capacitive load column that matches the application requirement (5 pF to 60 pF)
3. Under the capacitive load column, select the desired rise/fall times.
4. The left-most column represents the part number code for the corresponding drive strength.
5. Add the drive strength code to the part number for ordering purposes.

### Calculating Maximum Frequency

Based on the rise and fall time data given in Tables 1 through 4, the maximum frequency the oscillator can operate with guaranteed full swing of the output voltage over temperature as follows:

$$\text{Max Frequency} = \frac{1}{6 \times (\text{Trise})}$$

### Example 1

Calculate  $f_{\text{MAX}}$  for the following condition:

- V<sub>dd</sub> = 1.8V (Table 1)
- Capacitive Load: 30 pF
- Desired Tr/f time = 3 ns (rise/fall time part number code = E)

Part number for the above example:

SiT8008AIE12-18E-25.000000T



Drive strength code is inserted here. Default setting is “-”

### Rise/Fall Time (20% to 80%) vs C<sub>LOAD</sub> Tables

| Rise/Fall Time Typ (ns)            |      |       |       |       |       |
|------------------------------------|------|-------|-------|-------|-------|
| Drive Strength \ C <sub>LOAD</sub> | 5 pF | 15 pF | 30 pF | 45 pF | 60 pF |
| L                                  | 6.16 | 11.61 | 22.00 | 31.27 | 39.91 |
| A                                  | 3.19 | 6.35  | 11.00 | 16.01 | 21.52 |
| R                                  | 2.11 | 4.31  | 7.65  | 10.77 | 14.47 |
| B                                  | 1.65 | 3.23  | 5.79  | 8.18  | 11.08 |
| T                                  | 0.93 | 1.91  | 3.32  | 4.66  | 6.48  |
| E                                  | 0.78 | 1.66  | 2.94  | 4.09  | 5.74  |
| U                                  | 0.70 | 1.48  | 2.64  | 3.68  | 5.09  |
| F or "-": default                  | 0.65 | 1.30  | 2.40  | 3.35  | 4.56  |

Table 1. V<sub>dd</sub> = 1.8V Rise/Fall Times for Specific C<sub>LOAD</sub>

| Rise/Fall Time Typ (ns)            |      |       |       |       |       |
|------------------------------------|------|-------|-------|-------|-------|
| Drive Strength \ C <sub>LOAD</sub> | 5 pF | 15 pF | 30 pF | 45 pF | 60 pF |
| L                                  | 4.13 | 8.25  | 12.82 | 21.45 | 27.79 |
| A                                  | 2.11 | 4.27  | 7.64  | 11.20 | 14.49 |
| R                                  | 1.45 | 2.81  | 5.16  | 7.65  | 9.88  |
| B                                  | 1.09 | 2.20  | 3.88  | 5.86  | 7.57  |
| T                                  | 0.62 | 1.28  | 2.27  | 3.51  | 4.45  |
| E or "-": default                  | 0.54 | 1.00  | 2.01  | 3.10  | 4.01  |
| U                                  | 0.43 | 0.96  | 1.81  | 2.79  | 3.65  |
| F                                  | 0.34 | 0.88  | 1.64  | 2.54  | 3.32  |

Table 2. V<sub>dd</sub> = 2.5V Rise/Fall Times for Specific C<sub>LOAD</sub>

| Rise/Fall Time Typ (ns)            |      |       |       |       |       |
|------------------------------------|------|-------|-------|-------|-------|
| Drive Strength \ C <sub>LOAD</sub> | 5 pF | 15 pF | 30 pF | 45 pF | 60 pF |
| L                                  | 3.77 | 7.54  | 12.28 | 19.57 | 25.27 |
| A                                  | 1.94 | 3.90  | 7.03  | 10.24 | 13.34 |
| R                                  | 1.29 | 2.57  | 4.72  | 7.01  | 9.06  |
| B                                  | 0.97 | 2.00  | 3.54  | 5.43  | 6.93  |
| T                                  | 0.55 | 1.12  | 2.08  | 3.22  | 4.08  |
| E or "-": default                  | 0.44 | 1.00  | 1.83  | 2.82  | 3.67  |
| U                                  | 0.34 | 0.88  | 1.64  | 2.52  | 3.30  |
| F                                  | 0.29 | 0.81  | 1.48  | 2.29  | 2.99  |

Table 3. V<sub>dd</sub> = 2.8V Rise/Fall Times for Specific C<sub>LOAD</sub>

| Rise/Fall Time Typ (ns)            |      |       |       |       |       |
|------------------------------------|------|-------|-------|-------|-------|
| Drive Strength \ C <sub>LOAD</sub> | 5 pF | 15 pF | 30 pF | 45 pF | 60 pF |
| L                                  | 3.60 | 7.21  | 11.97 | 18.74 | 24.30 |
| A                                  | 1.84 | 3.71  | 6.72  | 9.86  | 12.68 |
| R                                  | 1.22 | 2.46  | 4.54  | 6.76  | 8.62  |
| B                                  | 0.89 | 1.92  | 3.39  | 5.20  | 6.64  |
| T or "-": default                  | 0.51 | 1.00  | 1.97  | 3.07  | 3.90  |
| E                                  | 0.38 | 0.92  | 1.72  | 2.71  | 3.51  |
| U                                  | 0.30 | 0.83  | 1.55  | 2.40  | 3.13  |
| F                                  | 0.27 | 0.76  | 1.39  | 2.16  | 2.85  |

Table 4. V<sub>dd</sub> = 3.0V Rise/Fall Times for Specific C<sub>LOAD</sub>

| Rise/Fall Time Typ (ns)            |      |       |       |       |       |
|------------------------------------|------|-------|-------|-------|-------|
| Drive Strength \ C <sub>LOAD</sub> | 5 pF | 15 pF | 30 pF | 45 pF | 60 pF |
| L                                  | 3.39 | 6.88  | 11.63 | 17.56 | 23.59 |
| A                                  | 1.74 | 3.50  | 6.38  | 8.98  | 12.19 |
| R                                  | 1.16 | 2.33  | 4.29  | 6.04  | 8.34  |
| B                                  | 0.81 | 1.82  | 3.22  | 4.52  | 6.33  |
| T or "-": default                  | 0.46 | 1.00  | 1.86  | 2.60  | 3.84  |
| E                                  | 0.33 | 0.87  | 1.64  | 2.30  | 3.35  |
| U                                  | 0.28 | 0.79  | 1.46  | 2.05  | 2.93  |
| F                                  | 0.25 | 0.72  | 1.31  | 1.83  | 2.61  |

Table 5. V<sub>dd</sub> = 3.3V Rise/Fall Times for Specific C<sub>LOAD</sub>

### Instant Samples with Time Machine and Field Programmable Oscillators

SiTime supports a field programmable version of the SiT8008 low power oscillator for fast prototyping and real time customization of features. The [field programmable devices](#) (FP devices) are available for all five standard SiT8008 package sizes and can be configured to one's exact specification using the [Time Machine II](#), an USB powered MEMS oscillator programmer.

#### Customizable Features of the SiT8008 FP Devices Include

- Any frequency between 1 – 110 MHz
- Three frequency stability options,  $\pm 20$  PPM,  $\pm 25$  PPM,  $\pm 50$  PPM
- Two operating temperatures, -20 to 70°C or -40 to 85°C
- Five supply voltage options, 1.8V, 2.5V, 2.8V, 3.0V, 3.3V and 2.25 to 3.65V continuous
- Output drive strength

For more information regarding SiTime's field programmable solutions, visit <http://www.sitime.com/time-machine> and <http://www.sitime.com/fp-devices>.

SiT8008 is typically factory-programmed per customer ordering codes for volume delivery.

### Dimensions and Patterns

| Package Size – Dimensions (Unit: mm) <sup>[7]</sup> | Recommended Land Pattern (Unit: mm) <sup>[8]</sup> |
|---|--|
| <p><b>2.0 x 1.6 x 0.75 mm</b></p>                   |  |
| <p><b>2.5 x 2.0 x 0.75 mm</b></p>                   |  |
| <p><b>3.2 x 2.5 x 0.75 mm</b></p>                   |  |
| <p><b>5.0 x 3.2 x 0.75 mm</b></p>                   |  |

**Notes:**

- 7. Top marking: Y denotes manufacturing origin and XXXX denotes manufacturing lot number. The value of "Y" will depend on the assembly location of the device.
- 8. A capacitor value of 0.1  $\mu$ F between Vdd and GND is recommended.



### Dimensions and Patterns

| Package Size – Dimensions (Unit: mm) <sup>[9]</sup> | Recommended Land Pattern (Unit: mm) <sup>[10]</sup> |
|---|---|
| <p>7.0 x 5.0 x 0.90 mm</p>                          |   |

**Notes:**

- 9. Top marking: Y denotes manufacturing origin and XXXX denotes manufacturing lot number. The value of “Y” will depend on the assembly location of the device.
- 10. A capacitor value of 0.1  $\mu$ F between Vdd and GND is recommended.

### Ordering Information

#### SiT8008AC-12-18E -25.000625T

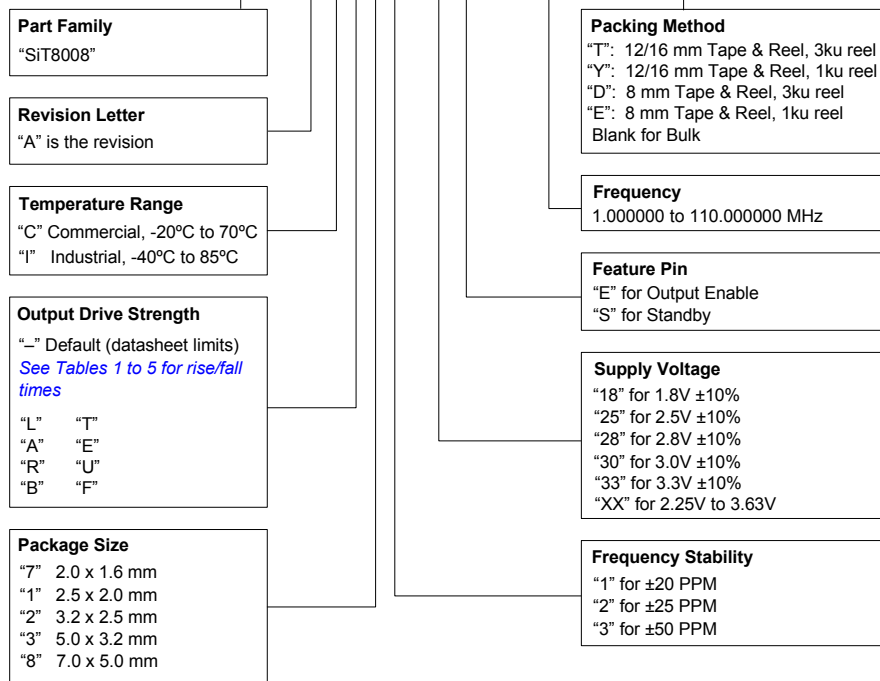

### Ordering Codes for Supported Tape & Reel Packing Method<sup>[11]</sup>

| Device Size  | 8 mm T&R (3ku) | 8 mm T&R (1ku) | 12 mm T&R (3ku) | 12 mm T&R (1ku) | 16 mm T&R (3ku) | 16 mm T&R (1ku) |
|--------------|----------------|----------------|-----------------|-----------------|-----------------|-----------------|
| 2.0 x 1.6 mm | D              | E              | -               | -               | -               | -               |
| 2.5 x 2.0 mm | D              | E              | -               | -               | -               | -               |
| 3.2 x 2.5 mm | D              | E              | -               | -               | -               | -               |
| 5.0 x 3.2 mm | -              | -              | T               | Y               | -               | -               |
| 7.0 x 5.0 mm | -              | -              | -               | -               | T               | Y               |

**Note:**

11. For "-", contact [SiTime](http://www.sitime.com) for availability.

### Additional Information

| Document                              | Description  | Download Link   |
|---------------------------------------|--|---|
| <b>Time Machine II</b>                | MEMS oscillator programmer   | <a href="http://www.sitime.com/support/time-machine-oscillator-programmer">http://www.sitime.com/support/time-machine-oscillator-programmer</a>   |
| <b>Field Programmable Oscillators</b> | Devices that can be programmable in the field by Time Machine II   | <a href="http://www.sitime.com/products/field-programmable-oscillators">http://www.sitime.com/products/field-programmable-oscillators</a>   |
| <b>Manufacturing Notes</b>            | Tape & Reel dimension, reflow profile and other manufacturing related info                               | <a href="http://www.sitime.com/component/docman/doc_download/85-manufacturing-notes-for-sitime-oscillators">http://www.sitime.com/component/docman/doc_download/85-manufacturing-notes-for-sitime-oscillators</a> |
| <b>Qualification Reports</b>          | RoHS report, reliability reports, composition reports  | <a href="http://www.sitime.com/support/quality-and-reliability">http://www.sitime.com/support/quality-and-reliability</a>   |
| <b>Performance Reports</b>            | Additional performance data such as phase noise, current consumption and jitter for selected frequencies | <a href="http://www.sitime.com/support/performance-measurement-report">http://www.sitime.com/support/performance-measurement-report</a>   |
| <b>Termination Techniques</b>         | Termination design recommendations   | <a href="http://www.sitime.com/support/application-notes">http://www.sitime.com/support/application-notes</a>   |
| <b>Layout Techniques</b>              | Layout recommendations   | <a href="http://www.sitime.com/support/application-notes">http://www.sitime.com/support/application-notes</a>   |

© SiTime Corporation 2013. The information contained herein is subject to change at any time without notice. SiTime assumes no responsibility or liability for any loss, damage or defect of a Product which is caused in whole or in part by (i) use of any circuitry other than circuitry embodied in a SiTime product, (ii) misuse or abuse including static discharge, neglect or accident, (iii) unauthorized modification or repairs which have been soldered or altered during assembly and are not capable of being tested by SiTime under its normal test conditions, or (iv) improper installation, storage, handling, warehousing or transportation, or (v) being subjected to unusual physical, thermal, or electrical stress.

**Disclaimer:** SiTime makes no warranty of any kind, express or implied, with regard to this material, and specifically disclaims any and all express or implied warranties, either in fact or by operation of law, statutory or otherwise, including the implied warranties of merchantability and fitness for use or a particular purpose, and any implied warranty arising from course of dealing or usage of trade, as well as any common-law duties relating to accuracy or lack of negligence, with respect to this material, any SiTime product and any product documentation. Products sold by SiTime are not suitable or intended to be used in a life support application or component, to operate nuclear facilities, or in other mission critical applications where human life may be involved or at stake. All sales are made conditioned upon compliance with the critical uses policy set forth below.

**CRITICAL USE EXCLUSION POLICY**  
 BUYER AGREES NOT TO USE SITIME'S PRODUCTS FOR ANY APPLICATION OR IN ANY COMPONENTS USED IN LIFE SUPPORT DEVICES OR TO OPERATE NUCLEAR FACILITIES OR FOR USE IN OTHER MISSION-CRITICAL APPLICATIONS OR COMPONENTS WHERE HUMAN LIFE OR PROPERTY MAY BE AT STAKE.

SiTime owns all rights, title and interest to the intellectual property related to SiTime's products, including any software, firmware, copyright, patent, or trademark. The sale of SiTime products does not convey or imply any license under patent or other rights. SiTime retains the copyright and trademark rights in all documents, catalogs and plans supplied pursuant to or ancillary to the sale of products or services by SiTime. Unless otherwise agreed to in writing by SiTime, any reproduction, modification, translation, compilation, or representation of this material shall be strictly prohibited.

# Supplemental Information

The Supplemental Information section is not part of the datasheet and is for informational purposes only.

# Silicon MEMS Outperforms Quartz

## Best Reliability

Silicon is inherently more reliable than quartz. Unlike quartz suppliers, SiTime has in-house MEMS and analog CMOS expertise, which allows SiTime to develop the most reliable products. Figure 1 shows a comparison with quartz technology.

### Why is SiTime Best in Class:

- SiTime’s MEMS resonators are vacuum sealed using an advanced Epi-Seal™ process, which eliminates foreign particles and improves long term aging and reliability
- World-class MEMS and CMOS design expertise



Figure 1. Reliability Comparison<sup>[1]</sup>

## Best Aging

Unlike quartz, MEMS oscillators have excellent long term aging performance which is why every new SiTime product specifies 10-year aging. A comparison is shown in Figure 2.

### Why is SiTime Best in Class:

- SiTime’s MEMS resonators are vacuum sealed using an advanced Epi-Seal™ process, which eliminates foreign particles and improves long term aging and reliability
- Inherently better immunity of electrostatically driven MEMS resonator



Figure 2. Aging Comparison<sup>[2]</sup>

## Best Electro Magnetic Susceptibility (EMS)

SiTime’s oscillators in plastic packages are up to 54 times more immune to external electromagnetic fields than quartz oscillators as shown in Figure 3.

### Why is SiTime Best in Class:

- Internal differential architecture for best common mode noise rejection
- Electrostatically driven MEMS resonator is more immune to EMS



Figure 3. Electro Magnetic Susceptibility (EMS)<sup>[3]</sup>

## Best Power Supply Noise Rejection

SiTime’s MEMS oscillators are more resilient against noise on the power supply. A comparison is shown in Figure 4.

### Why is SiTime Best in Class:

- On-chip regulators and internal differential architecture for common mode noise rejection
- Best analog CMOS design expertise



Figure 4. Power Supply Noise Rejection<sup>[4]</sup>

## Best Vibration Robustness

High-vibration environments are all around us. All electronics, from handheld devices to enterprise servers and storage systems are subject to vibration. Figure 5 shows a comparison of vibration robustness.

### Why is SiTime Best in Class:

- The moving mass of SiTime’s MEMS resonators is up to 3000 times smaller than quartz
- Center-anchored MEMS resonator is the most robust design



Figure 5. Vibration Robustness<sup>[5]</sup>

## Best Shock Robustness

SiTime’s oscillators can withstand at least 50,000 g shock. They all maintain their electrical performance in operation during shock events. A comparison with quartz devices is shown in Figure 6.

### Why is SiTime Best in Class:

- The moving mass of SiTime’s MEMS resonators is up to 3000 times smaller than quartz
- Center-anchored MEMS resonator is the most robust design



Figure 6. Shock Robustness<sup>[6]</sup>

### Notes:

1. Data Source: Reliability documents of named companies.
2. Data source: SiTime and quartz oscillator devices datasheets.
3. Test conditions for Electro Magnetic Susceptibility (EMS):
  - According to IEC EN61000-4.3 (Electromagnetic compatibility standard)
  - Field strength: 3V/m
  - Radiated signal modulation: AM 1 kHz at 80% depth
  - Carrier frequency scan: 80 MHz – 1 GHz in 1% steps
  - Antenna polarization: Vertical
  - DUT position: Center aligned to antenna

**Devices used in this test:**

  - SiTime, SiT9120AC-1D2-33E156.250000 - MEMS based - 156.25 MHz
  - Epson, EG-2102CA 156.2500M-PHPAL3 - SAW based - 156.25 MHz
  - TXC, BB-156.250MBE-T - 3rd Overtone quartz based - 156.25 MHz
  - Kyocera, KC7050T156.250P30E00 - SAW based - 156.25 MHz
  - Connor Winfield (CW), P123-156.25M - 3rd overtone quartz based - 156.25 MHz
  - SiLabs, Si590AB-BDG - 3rd overtone quartz based - 156.25 MHz
4. 50 mV pk-pk Sinusoidal voltage.
 

**Devices used in this test:**

  - SiTime, SiT8208AI-33-33E-25.000000, MEMS based - 25 MHz
  - NDK, NZ2523SB-25.6M - quartz based - 25.6 MHz
  - Kyocera, KC2016B25MOC1GE00 - quartz based - 25 MHz
  - Epson, SG-310SCF-25M0-MB3 - quartz based - 25 MHz
5. **Devices used in this test:** same as EMS test stated in Note 3.
6. Test conditions for shock test:
  - MIL-STD-883F Method 2002
  - Condition A: half sine wave shock pulse, 500-g, 1ms
  - Continuous frequency measurement in 100 μs gate time for 10 seconds

**Devices used in this test:** same as EMS test stated in Note 3
7. Additional data, including setup and detailed results, is available upon request to qualified customers. Please contact [productsupport@sitime.com](mailto:productsupport@sitime.com).

# Document Feedback Form



The Smart Timing Choice™

SiTime values your input in improving our documentation. Click [here](#) for our online feedback form or fill out and email the form below to [productsupport@sitime.com](mailto:productsupport@sitime.com)

1. Does the Electrical Characteristics table provide complete information? Yes No

If No, what parameters are missing?

---

2. Is the organization of this document easy to follow? Yes No

If "No," please suggest improvements that we can make:

---

3. Is there any application specific information that you would like to see in this document? (Check all that apply)

EMI Termination recommendations Shock and vibration performance Other

If "Other," please specify:

---

4. Are there any errors in this document? Yes No

If "Yes", please specify (what and where):

---

5. Do you have additional recommendations for this document?

---

Name \_\_\_\_\_

Title \_\_\_\_\_

Company \_\_\_\_\_

Address \_\_\_\_\_

City / State or Province / Postal Code / Country \_\_\_\_\_

Telephone \_\_\_\_\_

Application \_\_\_\_\_

Would you like a reply? Yes No

Thank you for your feedback. Please click the email icon in your Adobe Reader tool bar and send to [productsupport@sitime.com](mailto:productsupport@sitime.com). Or you may use our [online feedback form](#).



## X-ON Electronics

Largest Supplier of Electrical and Electronic Components

*Click to view similar products for [sitime manufacturer](#):*

Other Similar products are found below :

[SiT6100DK](#) [SiT8920AM-31-33N-40.000000](#) [SiT8103AI-22-33E-33.33300X](#) [9121AI-2C2-25E200.000000](#) [9121AC-2C3-25E100.00000](#)  
[9102AI-233N25E200.00000](#) [9102AC-283N25E200.00000](#) [SiT1602AI-32-33E-50.000000X](#) [SIT5000AICGE-33N0-25.000000X](#) [SiT3808AI-](#)  
[C2-33E-27.000000D](#) [SiT8008BI-72-33E-30.000000](#) [SiT8008BI-72-33E-31.250000](#) [SiT8008BI-72-33E-33.000000](#) [SiT8008BI-72-33E-](#)  
[48.000000](#) [SiT8008BI-72-33E-66.000000](#) [SiT8008BI-72-33E-66.600000](#) [SiT8008BI-72-33E-66.660000](#) [SiT8008BI-72-33E-66.666000](#)  
[SiT8008BI-72-33E-74.176000](#) [SiT8008BI-72-33E-77.760000](#) [SiT1602BI-72-33E-7.372800](#) [SiT1602BI-72-33E-10.000000](#) [SiT1602BI-72-](#)  
[33E-24.576000](#) [SiT1602BI-72-33E-33.300000](#) [SiT1602BI-72-33E-40.500000](#) [SiT1602BI-72-33E-54.000000](#) [SiT1602BI-72-33E-66.666000](#)  
[SiT1602BI-72-33E-66.666600](#) [SiT1602BI-72-33E-66.666660](#) [SiT1602BI-72-33E-77.760000](#) [SiT8008BI-72-33E-20.000000](#) [SiT8008BI-72-](#)  
[33E-32.768000](#) [SiT8008BI-72-33E-37.500000](#) [SiT8008BI-72-33E-40.500000](#) [SiT8008BI-72-33E-74.250000](#) [SiT1602BI-72-33E-33.330000](#)  
[SiT1602BI-72-33E-60.000000](#) [SiT1602BI-72-33E-66.660000](#) [SIT8103AI-88-33E-25.000000Z](#) [SIT8103AC-82-18E-16.384000Z](#) [SiT8008AI-](#)  
[11-18E-27.000000E](#) [SiT8008BI-82-33E-25.000625](#) [SiT8008BI-82-33E-28.636300](#) [SiT8008BI-82-33E-33.333300](#) [SiT8008BI-82-33E-](#)  
[60.000000](#) [SiT8008BI-82-33E-65.000000](#) [SiT8008BI-82-33E-66.666600](#) [SiT8008BI-82-33E-66.666660](#) [SiT8008BI-82-33E-74.175824](#)  
[SiT1602BI-82-33E-1.000000](#)