

## OMNIMATE Signal - series LMF LMFS 5.00/05/180 3.5SN OR BX

**Weidmüller Interface GmbH & Co. KG**  
Klingenbergstraße 16  
D-32758 Detmold  
Germany  
Fon: +49 5231 1429-0  
Fax: +49 5231 14292083  
www.weidmueller.com

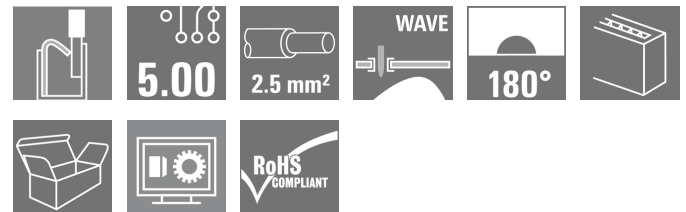

The new LMF allows us to meet the current market requirements for a PCB terminal with PUSH IN connection system for wire cross-sections up to 2.5 mm<sup>2</sup>

- PUSH IN connection system
- LMF with pusher for opening the terminal point
- LMFS without pusher, the terminal point is opened with a screwdriver
- Integrated test point
- 90° and 180° wire outlet direction

### General ordering data

Type	LMFS 5.00/05/180 3.5SN OR BX
Order No.	<a href="#">1330470000</a>
Version	PCB terminal, 5.00 mm, No. of poles: 5, 180°, Solder pin length (l): 3.5 mm, tinned, Orange, PUSH IN without actuator, Clamping range, rated connection, max.: 2.5 mm <sup>2</sup> , Box
GTIN (EAN)	4050118134605
Qty.	55 pc(s).
Product data	IEC: 400 V / 24 A / 0.2 - 2.5 mm <sup>2</sup> UL: 300 V / 10 A / AWG 26 - AWG 12
Packaging	Box

**OMNIMATE Signal - series LMF  
LMFS 5.00/05/180 3.5SN OR BX**

**Weidmüller Interface GmbH & Co. KG**  
 Klingenbergstraße 16  
 D-32758 Detmold  
 Germany  
 Fon: +49 5231 1429-0  
 Fax: +49 5231 14292083  
 www.weidmueller.com

**Technical data****Dimensions and weights**

Net weight	9.4 g
------------	-------

**System parameters**

Product family	OMNIMATE Signal - series LMF	Wire connection method	PUSH IN without actuator
Mounting onto the PCB	THT solder connection	Conductor outlet direction	180°
Pitch in mm (P)	5 mm	Pitch in inches (P)	0.197 inch
No. of poles	5	Fitted by customer	No
Max. adjacent poles per row	24	Solder pin length (l)	3.5 mm
Solder pin dimensions	d = 0.8 mm	Solder eyelet hole diameter (D)	1.1 mm
Solder eyelet hole diameter tolerance (D)	+ 0,1 mm	Number of solder pins per pole	2
Screwdriver blade	0.6 x 3.5	Screwdriver blade standard	DIN 5264
Stripping length	10 mm	L1 in mm	20 mm
L1 in inches	0.787 inch	Touch-safe protection acc. to DIN VDE 0470	IP 20
Touch-safe protection acc. to DIN VDE 57 106	Safe from finger touch		

**Material data**

Insulating material	Wemid (PA)	Colour	Orange
Colour chart (similar)	RAL 2000	CTI	≥ 600
Insulation resistance	≥ 10 <sup>8</sup> Ω	UL 94 flammability rating	V-0
Contact material	CuSn	Contact surface	tinned
Coating	4-6 µm SN	Tinning type	matt
Layer structure of solder connection	4-6 µm Sn matt	Storage temperature, min.	-25 °C
Storage temperature, max.	55 °C	Max. relative humidity during storage	80 %
Operating temperature, min.	-50 °C	Operating temperature, max.	120 °C
Temperature range, installation, min.	-25 °C	Temperature range, installation, max.	120 °C

**Conductors suitable for connection**

Clamping range, rated connection, min.	0.12 mm <sup>2</sup>	Clamping range, rated connection, max.	2.5 mm <sup>2</sup>
Wire connection cross section AWG, min.	AWG 26	Wire connection cross section AWG, max.	AWG 12
Solid, min. H05(07) V-U	0.2 mm <sup>2</sup>	Solid, max. H05(07) V-U	2.5 mm <sup>2</sup>
Flexible, min. H05(07) V-K	0.2 mm <sup>2</sup>	Flexible, max. H05(07) V-K	2.5 mm <sup>2</sup>
w. plastic collar ferrule, DIN 46228 pt 4, min.	0.25 mm <sup>2</sup>	w. plastic collar ferrule, DIN 46228 pt 4, max.	2.5 mm <sup>2</sup>
w. wire end ferrule, DIN 46228 pt 1, min.	0.25 mm <sup>2</sup>	w. wire end ferrule, DIN 46228 pt 1, max.	2.5 mm <sup>2</sup>
Plug gauge acc. to EN 60999 a x b; Ø	2.4 mm x 1.5 mm		

**OMNIMATE Signal - series LMF**  
**LMFS 5.00/05/180 3.5SN OR BX**

**Weidmüller Interface GmbH & Co. KG**  
 Klingenbergstraße 16  
 D-32758 Detmold  
 Germany  
 Fon: +49 5231 1429-0  
 Fax: +49 5231 14292083  
 www.weidmueller.com

**Technical data**

**Rated data acc. to IEC**

tested acc. to standard	IEC 60664-1, IEC 61984	Rated current, min. no. of poles (Ta = 20°C)	24 A
Rated current, max. no. of poles (Ta = 20°C)	24 A	Rated current, min. no. of poles (Ta = 40°C)	24 A
Rated current, max. no. of poles (Ta = 40°C)	24 A	Rated voltage for surge voltage class / pollution degree II/2	400 V
Rated voltage for surge voltage class / pollution degree III/2	320 V	Rated voltage for surge voltage class / pollution degree III/3	250 V
Rated impulse voltage for surge voltage class/ pollution degree II/2	4 kV	Rated impulse voltage for surge voltage class/ pollution degree III/2	4 kV
Rated impulse voltage for surge voltage class/ contamination degree III/3	4 kV	Short-time withstand current resistance	3 x 1s with 120 A

**Rated data acc. to CSA**

Institute (CSA)		Certificate No. (CSA)	200039-1815154
Rated voltage (Use group B)	300 V	Rated voltage (Use group C)	50 V
Rated voltage (use group D)	300 V	Rated current (use group B)	10 A
Rated current (use group C)	10 A	Rated current (use group D)	10 A
Wire cross-section, AWG, min.	AWG 26	Wire cross-section, AWG, max.	AWG 12
Reference to approval values	Specifications are maximum values, details - see approval certificate.		

**Rated data acc. to UL 1059**

Institute (cURus)		Certificate No. (cURus)	E60693
Rated voltage (use group B)	300 V	Rated voltage (use group C)	50 V
Rated voltage (use group D)	300 V	Rated current (use group B)	10 A
Rated current (use group C)	10 A	Rated current (use group D)	10 A
Wire cross-section, AWG, min.	AWG 26	Wire cross-section, AWG, max.	AWG 12
Reference to approval values	Specifications are maximum values, details - see approval certificate.		

**Classifications**

ETIM 3.0	EC001284	ETIM 4.0	EC002643
ETIM 5.0	EC002643	ETIM 6.0	EC002643
eClass 6.2	27-26-11-01	eClass 7.1	27-44-04-01
eClass 8.1	27-44-04-01	eClass 9.0	27-44-04-01
eClass 9.1	27-44-04-01		

**Data sheet**

**OMNIMATE Signal - series LMF  
LMFS 5.00/05/180 3.5SN OR BX**

**Weidmüller Interface GmbH & Co. KG**  
Klingenbergstraße 16  
D-32758 Detmold  
Germany  
Fon: +49 5231 1429-0  
Fax: +49 5231 14292083  
www.weidmueller.com

**Technical data**

**Notes**

- |       |  |
|-------|--|
| Notes | <ul style="list-style-type: none"> <li>• Additional colours on request</li> <br/> <li>• Rated current related to rated cross-section &amp; min. No. of poles.</li> <br/> <li>• Wire end ferrule without plastic collar to DIN 46228/1</li> <br/> <li>• Wire end ferrule with plastic collar to DIN 46228/4</li> <br/> <li>• P on drawing = pitch</li> <br/> <li>• Rated data refer only to the component itself. Clearance and creepage distances to other components are to be designed in accordance with the relevant application standards.</li> <br/> <li>• The test point can only be used as potential-pickup point.</li> </ul> |
|-------|--|

IPC conformity	The products are developed, manufactured and delivered according to the internationally recognised IPC-A-610 standard, category "permissible". More extensive demands on the products can be evaluated on request.
----------------	--

**Approvals**

Approvals



ROHS	Conform
------	---------

**Downloads**

Approval/Certificate/Document of Conformity	<a href="#">Declaration of the Manufacturer</a>
Brochure/Catalogue	<a href="#">FL DRIVES EN</a> <a href="#">FL ANALO.SIGN.CONV. EN</a> <a href="#">MB DEVICE MANUF. EN</a> <a href="#">FL DRIVES DE</a> <a href="#">CAT 2 PORTFOLIOGUIDE EN</a> <a href="#">FL BUILDING SAFETY EN</a> <a href="#">FL APPL LED LIGHTING EN</a> <a href="#">FLIndustr.CONTROLS EN</a> <a href="#">FL MACHINE SAFETY EN</a> <a href="#">FL HEATING ELECTR EN</a> <a href="#">FL APPL INVERTER EN</a> <a href="#">FL_BASE_STATION_EN</a> <a href="#">FL ELEVATOR EN</a> <a href="#">FL POWER SUPPLY EN</a> <a href="#">FL 72H SAMPLE SER EN</a> <a href="#">PO OMNIMATE EN</a>
Engineering Data	<a href="#">EPLAN, WSCAD</a>

**Data sheet**

**OMNIMATE Signal - series LMF  
LMFS 5.00/05/180 3.5SN OR BX**

**Weidmüller Interface GmbH & Co. KG**  
Klingenbergstraße 16  
D-32758 Detmold  
Germany  
Fon: +49 5231 1429-0  
Fax: +49 5231 14292083  
www.weidmueller.com

**Drawings**

**Dimensional drawing**

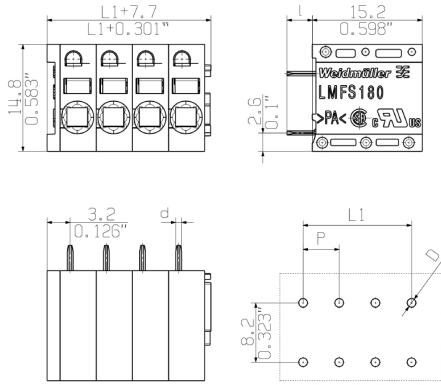

**Graph**

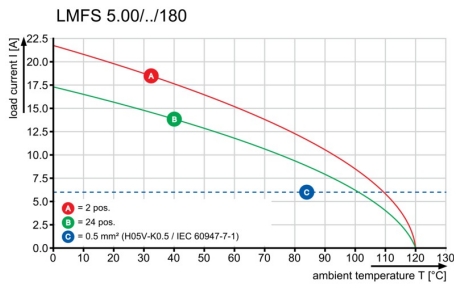

**Graph**

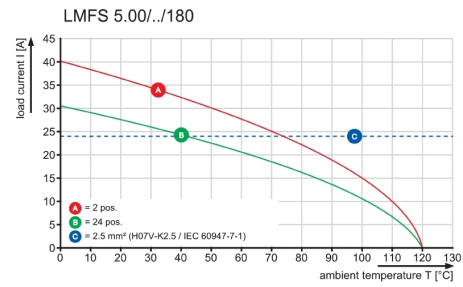

## Recommended wave soldering profiles

**Weidmüller Interface GmbH & Co. KG**  
 Klingenbergstraße 16  
 D-32758 Detmold  
 Germany  
 Fon: +49 5231 14-0  
 Fax: +49 5231 14-292083  
 www.weidmueller.com

### Single Wave:

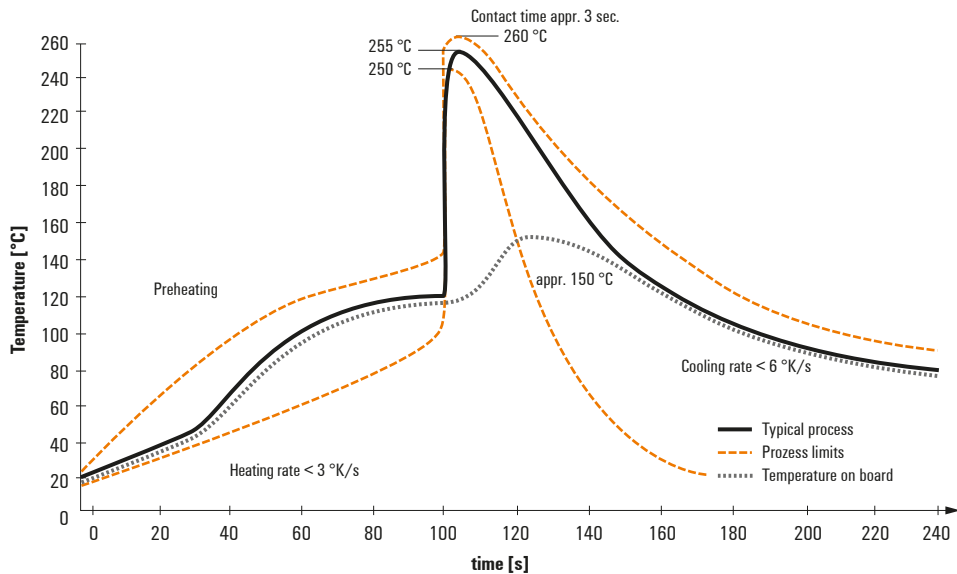

### Double Wave:

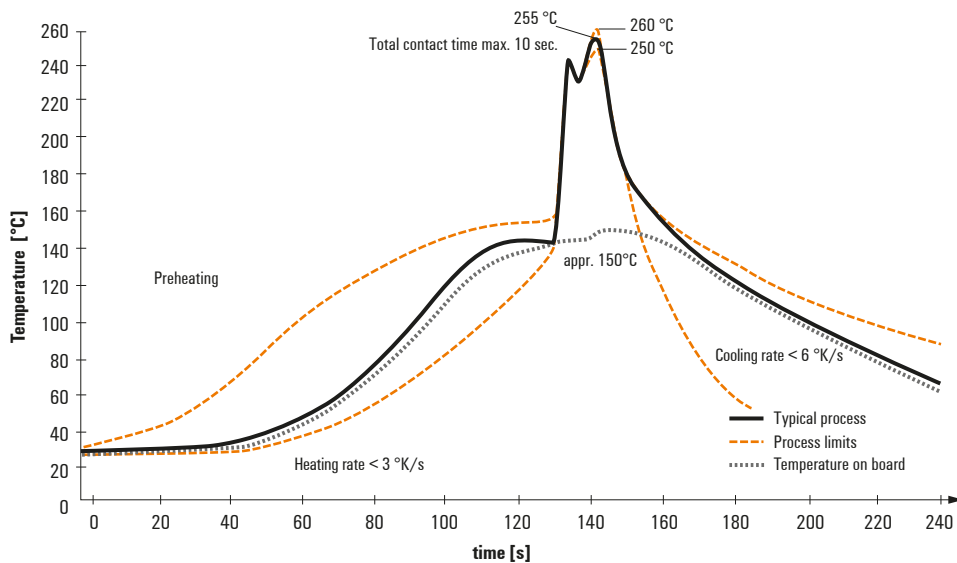

### Wave soldering profiles

Wired connection elements should be processed in accordance with the DIN EN 61760-1 standard. We have included two recommendations for practical wave soldering profiles, with which Weidmüller PCB terminals and connectors are qualified.

When choosing a suitable profile for your application, the following factors also need to be considered:

- PCB thickness
- Proportion of Cu in the layers
- Single/double-sided assembly
- Product range
- Heating and cooling rates

The single and double wave profiles each indicate the recommended operating range, including the maximum soldering temperature of 260°C. In practice, the maximum soldering temperature is quite often well below the above maximum profile.

## X-ON Electronics

Largest Supplier of Electrical and Electronic Components

*Click to view similar products for [weidmuller](#) manufacturer:*

Other Similar products are found below :

[8924550000](#) [56956](#) [0133660000](#) [6720000227](#) [6720005111](#) [68676](#) [69718](#) [EXO24CH](#) [7760056348](#) [7940000218](#) [8005181001](#) [8008180000](#)  
[8432240000](#) [8463580000](#) [8545830000](#) [8689870000](#) [8705640000](#) [9001080000](#) [9003720000](#) [9004250000](#) [9004780000](#) [9013260000](#)  
[9014100000](#) [9019040000](#) [9026010000](#) [9028630000](#) [903708](#) [9037350000](#) [9046290000](#) [9129643500](#) [913155](#) [9159530000](#) [919656](#) [919764](#)  
[9202230000](#) [9202850000](#) [9456750000](#) [9457913000](#) [980811](#) [980826](#) [9912800003](#) [9916080000](#) [9916280012](#) [9918380000](#) [9919371205](#)  
[9919371224](#) [9925710000](#) [9927480024](#) [1166660000](#) [11751](#)