

OMNIMATE Signal - series LSF LSF-SMD 5.00/08/180 SN BK RL

Weidmüller Interface GmbH & Co. KG
Klingenbergstraße 16
D-32758 Detmold
Germany
Fon: +49 5231 1429-0
Fax: +49 5231 14292083
www.weidmueller.com



The innovative quick connector - simple, safe and economical:

PCB terminals with spring connection and direct PUSH IN technology. A milestone in connection technology.

Amazingly simple and simply amazing in practice:

- Connect and easily detach solid wires or wires with wire-end ferrules without using tools
- Processed automatically in the reflow or vapour phase
- Potentials and clamping points marked clearly by coloured push buttons

World-class design-in and processing phases, and suitable for a vast range of applications. **PCB terminal for fully automatic assembly using reflow soldering (SMD), with PUSH IN wire connections. Conductor insertion and slider operation from the same direction (TOP).**

- **Solid & flexible conductors with wire-end ferrules need only to be inserted and they are ready.**
- **When connecting stranded wires without wire-end ferrules the actuating element is used to open the terminal point**
- **Intuitive handling – since the wire-entry area and handling area are clearly separated.**
- **Packaged in tape-on-reel**
- **Conductor outlet direction 180°**

General ordering data

Type	LSF-SMD 5.00/08/180 SN BK RL
Order No.	1473680000
Version	PCB terminal, 5.00 mm, No. of poles: 8, 180°, Black, PUSH IN, Clamping range, rated connection, max.: 1.5 mm ² , Tape (Ø 330 mm); Rs = 10 ⁹ - 10 ¹² Ω
GTIN (EAN)	4050118280302
Qty.	180 pc(s).
Product data	IEC: 500 V / 17.5 A / 0.2 - 1.5 mm ² UL: 300 V / 12 A / AWG 24 - AWG 16
Packaging	Tape (Ø 330 mm); Rs = 10 ⁹ - 10 ¹² Ω

OMNIMATE Signal - series LSF
LSF-SMD 5.00/08/180 SN BK RL

Weidmüller Interface GmbH & Co. KG
 Klingenbergstraße 16
 D-32758 Detmold
 Germany
 Fon: +49 5231 1429-0
 Fax: +49 5231 14292083
 www.weidmueller.com

Technical data**Dimensions and weights**

Net weight	7.271 g
------------	---------

System parameters

Product family	OMNIMATE Signal - series LSF	Wire connection method	PUSH IN
Mounting onto the PCB	SMD solder connection	Conductor outlet direction	180°
Pitch in mm (P)	5 mm	Pitch in inches (P)	0.197 inch
No. of poles	8	Fitted by customer	No
Coplanarity:	100 µm	Number of solder pins per pole	2
Stripping length	8 mm	L1 in mm	35 mm
L1 in inches	1.378 inch	Touch-safe protection acc. to DIN VDE 0470	IP 20
Touch-safe protection acc. to DIN VDE 57 106	Safe from finger touch	Volume resistance	1.60 mΩ

Material data

Insulating material	LCP GF	Colour	Black
Colour chart (similar)	RAL 9011	Insulating material group	IIIa
CTI	≥ 175	Insulation resistance	≥ 10 ⁸ Ω
Moisture Level (MSL)	1	UL 94 flammability rating	V-0
Contact material	Copper alloy	Layer structure of solder connection	4-6 µm Sn matt
Storage temperature, min.	-25 °C	Storage temperature, max.	55 °C
Max. relative humidity during storage	80 %	Operating temperature, min.	-50 °C
Operating temperature, max.	120 °C	Temperature range, installation, min.	-30 °C
Temperature range, installation, max.	120 °C		

Conductors suitable for connection

Clamping range, rated connection, min.	0.13 mm ²	Clamping range, rated connection, max.	1.5 mm ²
Wire connection cross section AWG, min.	AWG 24	Wire connection cross section AWG, max.	AWG 16
Solid, min. H05(07) V-U	0.2 mm ²	Solid, max. H05(07) V-U	1.5 mm ²
Flexible, min. H05(07) V-K	0.2 mm ²	Flexible, max. H05(07) V-K	1.5 mm ²
w. plastic collar ferrule, DIN 46228 pt 4, min.	0.25 mm ²	w. plastic collar ferrule, DIN 46228 pt 4, max.	0.75 mm ²
w. wire end ferrule, DIN 46228 pt 1, min	0.25 mm ²	w. wire end ferrule, DIN 46228 pt 1, max.	1.5 mm ²

Rated data acc. to IEC

tested acc. to standard	IEC 60664-1, IEC 61984	Rated current, min. no. of poles (Ta = 20°C)	17.5 A
Rated current, max. no. of poles (Ta = 20°C)	17.5 A	Rated current, min. no. of poles (Ta = 40°C)	17.5 A
Rated current, max. no. of poles (Ta = 40°C)	15 A	Rated voltage for surge voltage class / pollution degree II/2	500 V
Rated voltage for surge voltage class / pollution degree III/2	320 V	Rated voltage for surge voltage class / pollution degree III/3	250 V
Rated impulse voltage for surge voltage class/ pollution degree II/2	4 kV	Rated impulse voltage for surge voltage class/ pollution degree III/2	4 kV
Rated impulse voltage for surge voltage class/ contamination degree III/3	4 kV	Short-time withstand current resistance	3 x 1s with 80 A

OMNIMATE Signal - series LSF
LSF-SMD 5.00/08/180 SN BK RL

Weidmüller Interface GmbH & Co. KG
 Klängenbergstraße 16
 D-32758 Detmold
 Germany
 Fon: +49 5231 1429-0
 Fax: +49 5231 14292083
 www.weidmueller.com

Technical data**Rated data acc. to CSA**

Institute (CSA)		Certificate No. (CSA)	200039-1664286
Rated voltage (Use group B)	300 V	Rated voltage (use group D)	300 V
Rated current (use group B)	10 A	Rated current (use group D)	10 A
Wire cross-section, AWG, min.	AWG 24	Wire cross-section, AWG, max.	AWG 16
Reference to approval values	Specifications are maximum values, details - see approval certificate.		

Rated data acc. to UL 1059

Institute (cURus)		Certificate No. (cURus)	E60693
Rated voltage (use group B)	300 V	Rated voltage (use group D)	300 V
Rated current (use group B)	12 A	Rated current (use group D)	10 A
Wire cross-section, AWG, min.	AWG 24	Wire cross-section, AWG, max.	AWG 16
Reference to approval values	Specifications are maximum values, details - see approval certificate.		

Classifications

ETIM 3.0	EC001284	ETIM 4.0	EC002643
ETIM 5.0	EC002643	ETIM 6.0	EC002643
eClass 6.2	27-26-11-01	eClass 7.1	27-44-04-01
eClass 8.1	27-44-04-01	eClass 9.0	27-44-04-01
eClass 9.1	27-44-04-01		

Notes

Notes	<ul style="list-style-type: none"> • Additional push button colours on request • Operating force of slider max. 40 N • Rated current related to rated cross-section & min. No. of poles. • Wire end ferrule with plastic collar to DIN 46228/4 • Wire end ferrule without plastic collar to DIN 46228/1 • P on drawing = pitch • Rated data refer only to the component itself. Clearance and creepage distances to other components are to be designed in accordance with the relevant application standards. • Crimping shape "A" for wire end ferrules with PZ 6/5 crimping tool are recommended for the largest cable sizes.
IPC conformity	The products are developed, manufactured and delivered according to the internationally recognised IPC-A-610 standard, category "permissible". More extensive demands on the products can be evaluated on request.

Data sheet

**OMNIMATE Signal - series LSF
LSF-SMD 5.00/08/180 SN BK RL**

Weidmüller Interface GmbH & Co. KG
Klingenbergstraße 16
D-32758 Detmold
Germany
Fon: +49 5231 1429-0
Fax: +49 5231 14292083
www.weidmueller.com

Technical data

Approvals

Approvals



ROHS

Conform

Downloads

Approval/Certificate/Document of
Conformity

[Declaration of the Manufacturer](#)

Brochure/Catalogue

- [FL DRIVES EN](#)
- [PI OMNIMATE LSF SMD EN](#)
- [FL ANALO.SIGN.CONV. EN](#)
- [MB DEVICE MANUF. EN](#)
- [FL DRIVES DE](#)
- [FL BUILDING SAFETY EN](#)
- [FL APPL LED LIGHTING EN](#)
- [FLIndustr.CONTROLS EN](#)
- [FL MACHINE SAFETY EN](#)
- [FL HEATING ELECTR EN](#)
- [FL APPL_INVERTER EN](#)
- [FL_BASE_STATION_EN](#)
- [FL ELEVATOR EN](#)
- [FL POWER SUPPLY EN](#)
- [FL 72H SAMPLE SER EN](#)
- [PO OMNIMATE EN](#)

Engineering Data

[EPLAN, WSCAD](#)

SMT white paper

[Download Whitepaper](#)

OMNIMATE Signal - series LSF
LSF-SMD 5.00/08/180 SN BK RL

Weidmüller Interface GmbH & Co. KG
 Klingenbergstraße 16
 D-32758 Detmold
 Germany
 Fon: +49 5231 1429-0
 Fax: +49 5231 14292083
 www.weidmueller.com

Drawings

Dimensional drawing

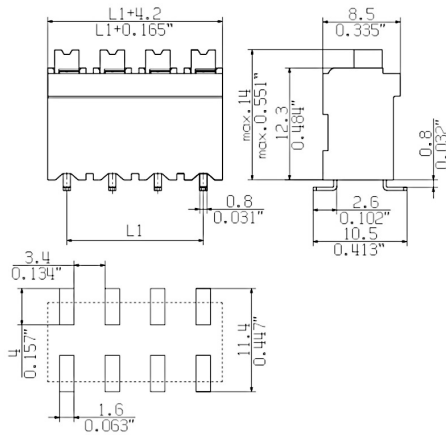

Graph

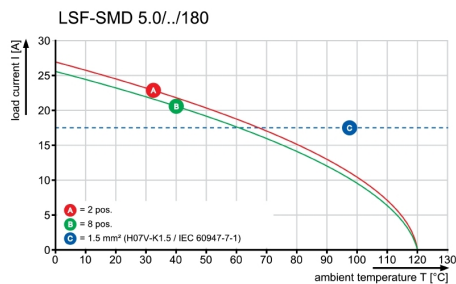

Empfohlene Wellen-Lötprofile

Weidmüller Interface GmbH & Co. KG
 Klingenbergstraße 16
 D-32758 Detmold
 Germany
 Fon: +49 5231 14-0
 Fax: +49 5231 14-292083
 www.weidmueller.com

Einzelwelle:

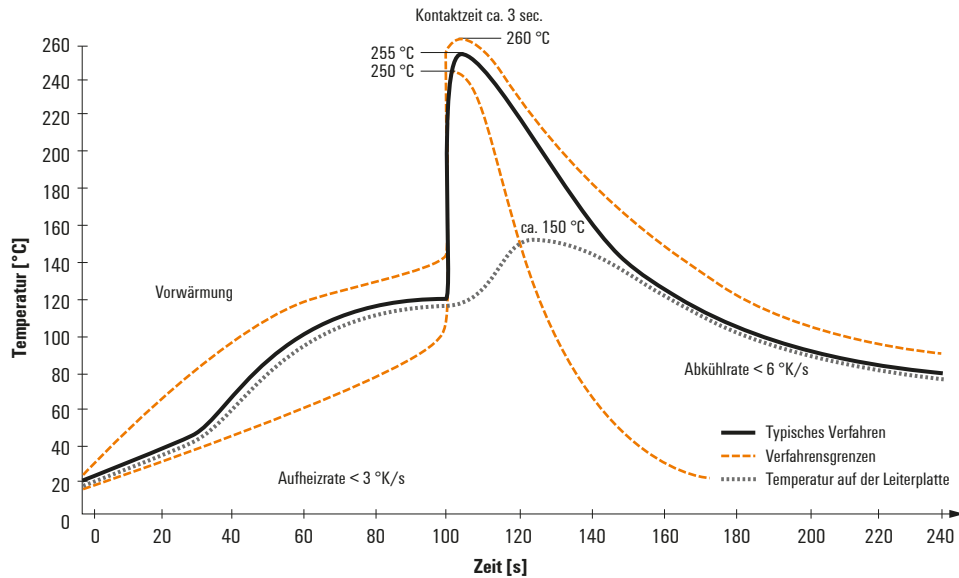

Doppelwelle:

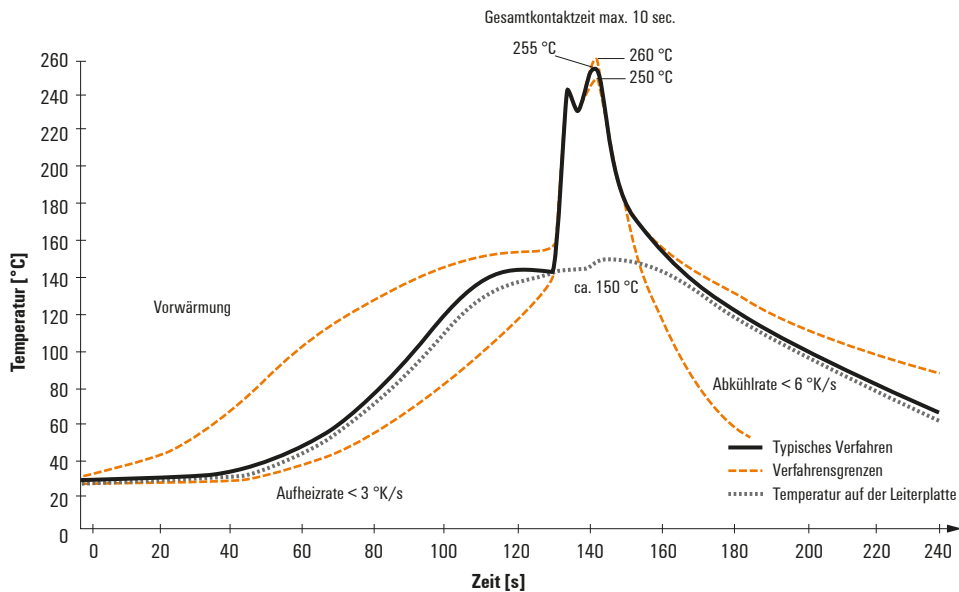

Wellen-Lötprofile

Bedrahtete Anschlüsselemente sind in Anlehnung an die Norm DIN EN 61760-1 zu verarbeiten. Anbei zwei Empfehlungen für praxisbezogene Wellenlötprofile, mit denen Leiterplattenanschlussklemmen und Steckverbinder von Weidmüller qualifiziert sind.

Bei der Wahl eines passenden Profils für Ihre Anwendung sind unter anderem folgende Faktoren zu beachten:

- Stärke der Leiterplatte
- Cu-Anteile in den Lagen
- Ein-/Beidseitige Bestückung
- Produktspektrum
- Aufheiz- und Abkühlrate

Die Einzel- und Doppelwelle zeigt jeweils den empfohlenen Verarbeitungsbereich inkl. der maximalen Löttemperatur von 260°C. In der Praxis liegt die maximale Löttemperatur sehr häufig weit unter dem o.g. Maximalprofil.

Recommended reflow soldering profile

Weidmüller Interface GmbH & Co. KG
 Klingenbergstraße 16
 D-32758 Detmold
 Germany
 Fon: +49 5231 14-0
 Fax: +49 5231 14-292083
 www.weidmueller.com

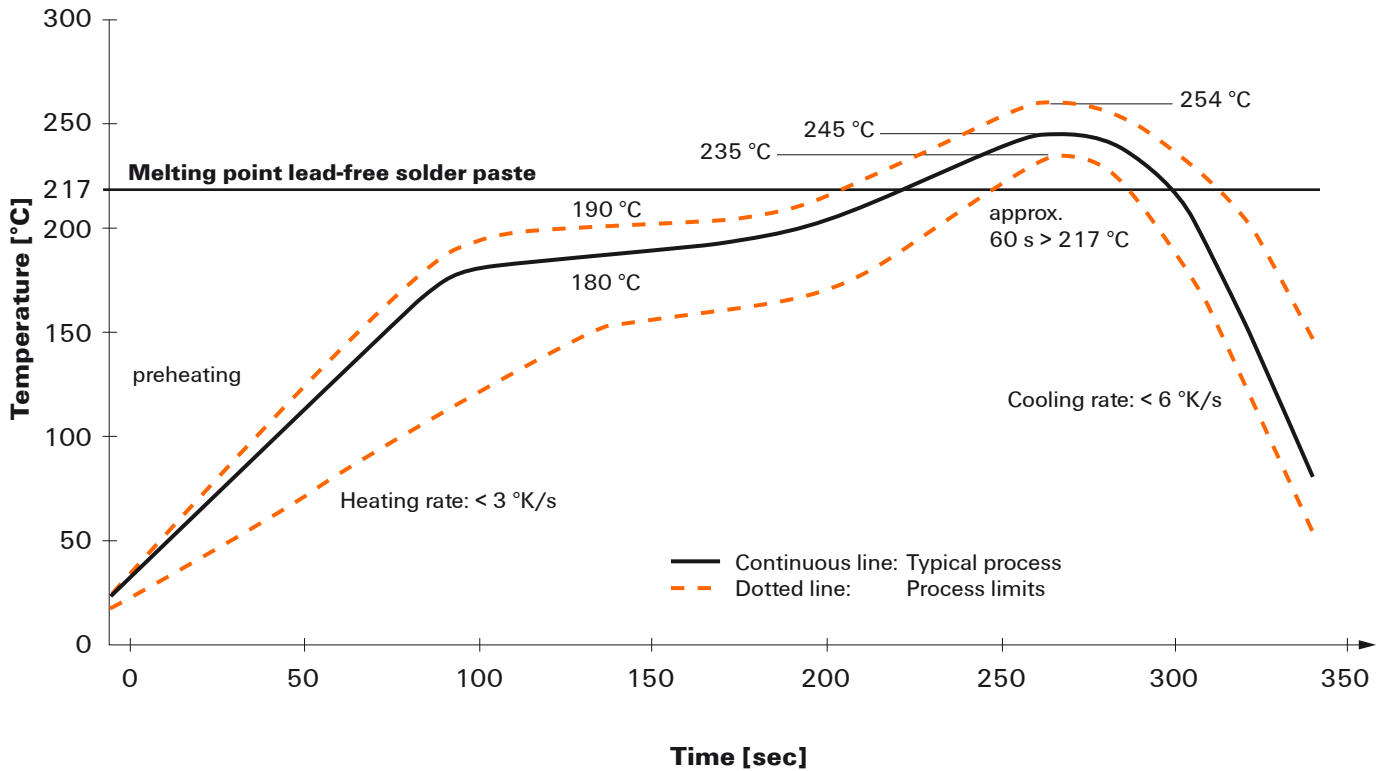

Reflow soldering profile

The perfect soldering profile for SMT Surface Mount Technology is one the most exiting question in SMT production. But there are more than one correct answer: The diagram of temperature-on-time is related to processing features of solder paste and to maximum load of components.

We have to consider the following parameters:

- Time for pre heating
- Maximum temperature
- Time above melting point
- Time for cooling
- Maximum heating rate
- Maximum cooling rate

We recommend a typical solder profile with associated process limits. With preheating components and board are prepared smoothly for the solder phase. Heating rate is typically $\leq +3\text{K/s}$. In parallel the solder paste is ‚activated‘. The time above melting point of 217°C the paste gets liquid and components and boards begin to connect. The maximum temperature of 245°C to 254°C should stay between 10 and 40 seconds. In the cooling phase at $\geq -6\text{K/s}$ solder is cured. Board and components cool down while avoiding cold cracks.

X-ON Electronics

Largest Supplier of Electrical and Electronic Components

Click to view similar products for [weidmuller](#) manufacturer:

Other Similar products are found below :

[8924550000](#) [56956](#) [0133660000](#) [6720000227](#) [6720005111](#) [68676](#) [69718](#) [EXO24CH](#) [7760056348](#) [7940000218](#) [8005181001](#) [8008180000](#)
[8432240000](#) [8463580000](#) [8545830000](#) [8689870000](#) [8705640000](#) [9001080000](#) [9003720000](#) [9004250000](#) [9004780000](#) [9013260000](#)
[9014100000](#) [9019040000](#) [9026010000](#) [9028630000](#) [903708](#) [9037350000](#) [9046290000](#) [9129643500](#) [913155](#) [9159530000](#) [919656](#) [919764](#)
[9202230000](#) [9202850000](#) [9456750000](#) [9457913000](#) [980811](#) [980826](#) [9912800003](#) [9916080000](#) [9916280012](#) [9918380000](#) [9919371205](#)
[9919371224](#) [9925710000](#) [9927480024](#) [1166660000](#) [11751](#)