

THE INFORMATION CONTAINED IN THIS DRAWING IS THE SOLE PROPERTY OF L-COM, INC. ANY REPRODUCTIONS IN PART OR WHOLE WITHOUT THE WRITTEN PERMISSION OF L-COM, INC. IS PROHIBITED.

REVISIONS			
REV	DESCRIPTION	DATE	CHANGED BY
A	DRAWING REPLACES DGBV15F-OD1	9/23/14	D.FRISIELLO

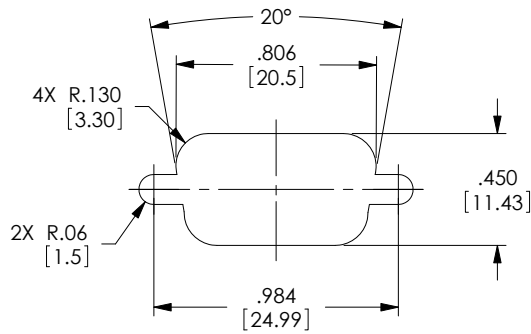

RECOMMENDED PANEL OPENING
(MAX PANEL THICKNESS: 0.06")

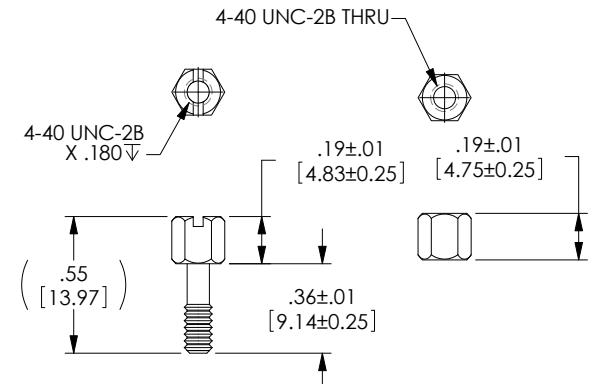
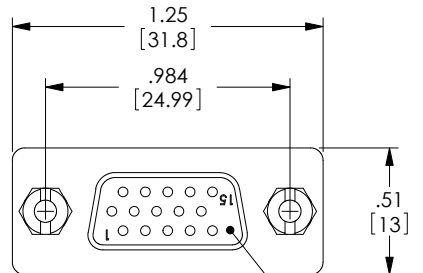
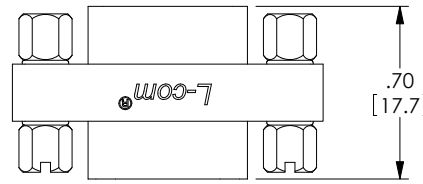

2X 15 PIN FEMALE
HIGH DENSITY
D-SUB CONNECTOR

JACKSCREW & HEX STANDOFF
SPECIFICATION

- NOTES:**
- MATERIAL:
 - SHELL: STEEL
 - CONTACTS: COPPER ALLOY
 - HARDWARE: BRASS
 - INSULATOR: PBT FIBER REINFORCED (UL94V-0 RATED)
 - FINISH:
 - SHELL: TIN/NICKEL PLATED
 - CONTACTS: GOLD FLASH PLATED
 - HARDWARE: NICKEL PLATED
 - ELECTRICAL:
 - CURRENT RATING: 3 AMP
 - MISCELLANEOUS:
 - OPERATING TEMPERATURE RANGE: -55 °C TO +105 °C.
 - PIN 9 IS OMITTED.
 - ALL CONTACTS ARE WIRED STRAIGHT THROUGH.
 - COMPONENT SHALL BE TESTED FOR CONTINUITY.
 - LABELING:
 - PANTONE 2945 BLUE. "L-COM" FONT MyriaMM ITALIC.
 - "GENDER CHANGER" FONT ARIAL BOLD, TEXT HEIGHTS; .085"
 - TEXT COLOR; WHITE.

4X .03^{+.00}_{-.03}
0
[0.69 -0.76]

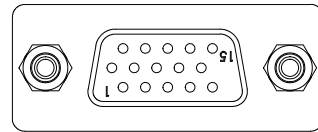
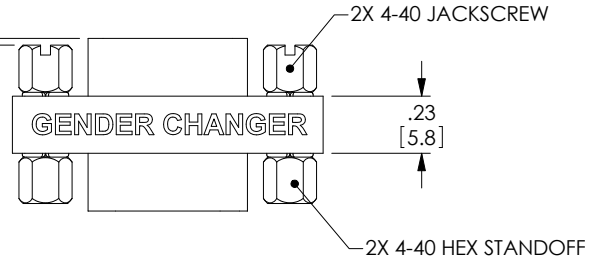

PACKAGING:
COMPONENT SHALL BE INDIVIDUALLY PACKAGED IN ACCORDANCE WITH L-COM SPECIFICATION PS-0031.

REGULATORY COMPLIANCE:
CE2011/65/EU (RoHS DIRECTIVE)

UNLESS OTHERWISE SPECIFIED,
DIMENSIONS ARE IN INCHES (mm)
OVERALL CABLE LENGTH TOLERANCE:
≤12 (305) ≤60 (1524) = +.015 / -0
>12 (305) ≤120 (3048) = +.020 / -0
>120 (3048) ≤300 (7620) = +.025 / -0
>300 (7620) = +.030 / -0
ALL OTHER DIMENSIONAL TOLERANCES:
X = ±.015 (0.38)
XX = ±.010 (0.25)
XXX = ±.005 (0.13)

APPROVALS	DATE
DRAWN BY D.FABRIM	11/12/2001
CHECKED BY T.CLARK	11/12/2001
APPROVED BY R.CARRICK	11/13/2001



CATEGORY D-SUBMINIATURE			
PRODUCT DESCRIPTION ADPT, VGA GNDR CHGR HD15F/F			
SIZE B	FSCM NO. 43321	DWG. NO. DGBV15F	REV. A
SCALE: 2:1		CAD FILE: DGBV15F.SLDDRW	
			SHEET 1 OF 1

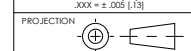

X-ON Electronics

Largest Supplier of Electrical and Electronic Components

Click to view similar products for [l-com](#) manufacturer:

Other Similar products are found below :

[FOA-550A](#) [UMC-201](#) [CSMN50MF-5](#) [CSMNB15MF-15](#) [TRD815RA2BL-5](#) [CA3A-90DA-1M](#) [CTLF3VGAMM-20](#) [HDCAMM-3](#)
[U3A00007-05M](#) [U3A00014-03M](#) [CSMT15MF-10](#) [CSMT15MM-15](#) [CSMT15MM-25](#) [CSPL15MF-50](#) [CSPL25MF-25](#) [CSPL9MF-10](#)
[CSPL9MF-5](#) [CSPL25MF-5](#) [CSPL25MF-2.5](#) [AL-IPEPS](#) [NB201611-10F-1](#) [TDG1026KC5-MNL](#) [NB121005-10F](#) [TRD855SRA6DBL-10M](#)
[TRD855SRA7DBL-1M](#) [TRD855SRA7DBL-10M](#) [U2A00017-05M](#) [PR175SCDLCQ24](#) [TRG508-T4T-3M](#) [TRA5261-15F](#) [TRA5261S-1F](#)
[TRA6261-1F](#) [USBBFT](#) [DGB25M](#) [HG2403RD-RSF](#) [CASATAL-18](#) [CSM25MM-10](#) [CSM37MF-10](#) [CSUSB-100](#) [CA3A-90RA-1M](#) [CA3A-](#)
[90MICB-1M](#) [U2A00003-3M](#) [U3A00003-05M](#) [U2A00008-12I](#) [U3A00007-075M](#) [U3A00007-1M](#) [HGV-903U](#) [CSMT15MF-5](#)
[CSMT15MM-50](#) [CSPL15MF-25](#)