

OMNIMATE Power - series LXXX LXXX 15.00/02/90F 4.5SN BK BX

Weidmüller Interface GmbH & Co. KG
Klingenbergstraße 16
D-32758 Detmold
Germany
Fon: +49 5231 1429-0
Fax: +49 5231 14292083
www.weidmueller.com

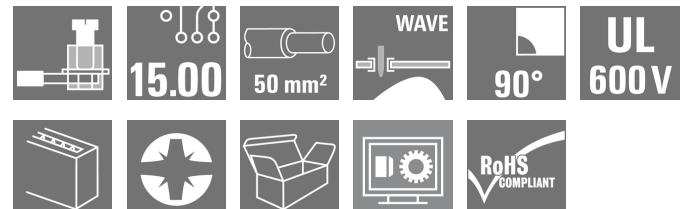

The high-current PCB connection for more power on board: 150 A / 1000 V with wires up to 50 mm², transmitted right to the PCB!

The LXXX 15.0 – with its proven steel clamping-yoke technology in a compact standard housing – integrates the latest market requirements for security, power density and miniaturization in power electronics. It connects these requirements into an efficient solution for the entire value-creation chain – including development, production, installation and maintenance.

The function and form of the application's connection method plays a key role. It influences the application's design, reliability, usability and costs. With the Substitution of

For example, with the replacement of complex constructions involving bolts or bus bars, the PCB can be transformed into a system platform that is both consistent and sustainable into the future – even for high-current applications.

The LXXX 15.0 reduces size and complexity while at the same time improving application integration. In so doing, it fulfils the requirements of power electronics better than the established mechanisms and connection elements.

General ordering data

Type	LXXX 15.00/02/90F 4.5SN BK BX
Order No.	1047290000
Version	PCB terminal, 15.00 mm, No. of poles: 2, 90°, Solder pin length (l): 4.5 mm, tinned, Black, Clamping yoke connection, Clamping range, rated connection, max.: 50 mm ² , Box
GTIN (EAN)	4032248783861
Qty.	20 pc(s).
Product data	IEC: 1000 V / 150 A / 0.5 - 50 mm ² UL: 600 V / 127 A / AWG 20 - AWG 1
Packaging	Box

**OMNIMATE Power - series LXXX
LXXX 15.00/02/90F 4.5SN BK BX**

Weidmüller Interface GmbH & Co. KG
 Klingenbergstraße 16
 D-32758 Detmold
 Germany
 Fon: +49 5231 1429-0
 Fax: +49 5231 14292083
 www.weidmueller.com

Technical data**Dimensions and weights**

Net weight 61 g

System parameters

Product family	OMNIMATE Power - series LXXX	Wire connection method	Clamping yoke connection
Mounting onto the PCB	THT solder connection	Conductor outlet direction	90°
Pitch in mm (P)	15 mm	Pitch in inches (P)	0.591 inch
No. of poles	2	Fitted by customer	No
Solder pin length (l)	4.5 mm	Solder pin dimensions	1.2 x 1.2 mm
Solder eyelet hole diameter (D)	1.6 mm	Solder eyelet hole diameter tolerance (D)+	0,1 mm
Number of solder pins per pole	4	Screwdriver blade	1.2 x 6.5
Screwdriver blade standard	DIN 5264	Tightening torque, min.	2.5 Nm
Tightening torque, max.	4 Nm	Clamping screw	M 6
Stripping length	18 mm	L1 in mm	15 mm
L1 in inches	0.591 inch		

Material data

Insulating material	Wemid (PA)	Colour	Black
Colour chart (similar)	RAL 9011	Insulating material group	I
CTI	≥ 600	Insulation resistance	≥ 10 ⁸ Ω
UL 94 flammability rating	V-0	Contact material	Copper alloy
Contact surface	tinned	Layer structure of solder connection	1.5-3 μm Ni / 4-6 μm Sn matt
Storage temperature, min.	-25 °C	Storage temperature, max.	55 °C
Max. relative humidity during storage	80 %	Operating temperature, min.	-50 °C
Operating temperature, max.	120 °C	Temperature range, installation, min.	-25 °C
Temperature range, installation, max.	120 °C		

Conductors suitable for connection

Clamping range, rated connection, min.	0.5 mm ²	Clamping range, rated connection, max.	50 mm ²
Wire connection cross section AWG, min.	AWG 20	Wire connection cross section AWG, max.	AWG 1
Solid, min. H05(07) V-U	0.5 mm ²	Solid, max. H05(07) V-U	16 mm ²
Stranded, min. H07V-R	6 mm ²	Stranded, max. H07V-R	50 mm ²
Flexible, min. H05(07) V-K	0.5 mm ²	Flexible, max. H05(07) V-K	35 mm ²
w. plastic collar ferrule, DIN 46228 pt 4, min.	0.5 mm ²	w. plastic collar ferrule, DIN 46228 pt 4, max.	35 mm ²
w. wire end ferrule, DIN 46228 pt 1, min	0.5 mm ²	w. wire end ferrule, DIN 46228 pt 1, max.	35 mm ²

Rated data acc. to IEC

tested acc. to standard	IEC 60664-1, IEC 61984	Rated current, min. no. of poles (Ta = 20°C)	150 A
Rated current, min. no. of poles (Ta = 40°C)	150 A	Rated voltage for surge voltage class / pollution degree II/2	1,000 V
Rated voltage for surge voltage class / pollution degree III/2	1,000 V	Rated voltage for surge voltage class / pollution degree III/3	1,000 V
Rated impulse voltage for surge voltage class/ pollution degree II/2	8 kV	Rated impulse voltage for surge voltage class/ pollution degree III/2	8 kV
Rated impulse voltage for surge voltage class/ contamination degree III/3	8 kV		

Creation date September 19, 2017 8:19:55 AM CEST

Catalogue status 18.09.2017 / We reserve the right to make technical changes.

**OMNIMATE Power - series LXXX
LXXX 15.00/02/90F 4.5SN BK BX**

Weidmüller Interface GmbH & Co. KG
 Klingenbergstraße 16
 D-32758 Detmold
 Germany
 Fon: +49 5231 1429-0
 Fax: +49 5231 14292083
 www.weidmueller.com

Technical data**Rated data acc. to CSA**

Institute (CSA)



Certificate No. (CSA)

200039-1198743

Rated voltage (Use group B)	600 V
Rated voltage (use group D)	600 V
Rated current (use group C)	127 A
Wire cross-section, AWG, min.	AWG 20
Reference to approval values	Specifications are maximum values, details - see approval certificate.

Rated voltage (Use group C)	600 V
Rated current (use group B)	127 A
Rated current (use group D)	5 A
Wire cross-section, AWG, max.	AWG 1

Rated data acc. to UL 1059

Institute (UR)



Certificate No. (UR)

E60693

Rated voltage (use group B)	600 V
Rated voltage (use group D)	600 V
Rated current (use group C)	127 A
Wire cross-section, AWG, min.	AWG 20
Reference to approval values	Specifications are maximum values, details - see approval certificate.

Rated voltage (use group C)	600 V
Rated current (use group B)	127 A
Rated current (use group D)	5 A
Wire cross-section, AWG, max.	AWG 1

Classifications

ETIM 3.0	EC001284	ETIM 4.0	EC002643
ETIM 5.0	EC002643	ETIM 6.0	EC002643
eClass 6.2	27-26-11-01	eClass 7.1	27-44-04-01
eClass 8.1	27-44-04-01	eClass 9.0	27-44-04-01
eClass 9.1	27-44-04-01		

Notes

Notes

- Additional colours on request
- Rated current related to rated cross-section & min. No. of poles.
- Wire end ferrule without plastic collar to DIN 46228/1
- Wire end ferrule with plastic collar to DIN 46228/4
- P on drawing = pitch
- Rated data refer only to the component itself. Clearance and creepage distances to other components are to be designed in accordance with the relevant application standards.
- IP 20 from 16 mm² to 50 mm²
- The test point can only be used as potential-pickup point.

IPC conformity

The products are developed, manufactured and delivered according to the internationally recognised IPC-A-610 standard, category "permissible". More extensive demands on the products can be evaluated on request.

Creation date September 19, 2017 8:19:55 AM CEST

Catalogue status 18.09.2017 / We reserve the right to make technical changes.

3

Data sheet**OMNIMATE Power - series LXXX
LXXX 15.00/02/90F 4.5SN BK BX****Weidmüller Interface GmbH & Co. KG**
Klingenbergstraße 16
D-32758 Detmold
Germany
Fon: +49 5231 1429-0
Fax: +49 5231 14292083
www.weidmueller.com**Technical data****Approvals**

Approvals



ROHS

Conform

DownloadsApproval/Certificate/Document of
Conformity[Declaration of the Manufacturer](#)

Brochure/Catalogue

[FL DRIVES EN](#)
[MB DEVICE MANUF. EN](#)
[FL DRIVES DE](#)
[CAT 2 PORTFOLIOGUIDE EN](#)
[FL APPL. INVERTER EN](#)
[FL_BASE_STATION_EN](#)
[FL ELEVATOR EN](#)
[FL POWER SUPPLY EN](#)
[FL 72H SAMPLE SER EN](#)
[PO OMNIMATE EN](#)

Engineering Data

[EPLAN_WSCAD](#)

Motion controllers white paper

[Download Whitepaper](#)

White Paper UL 600 V

[Download Whitepaper](#)

**OMNIMATE Power - series LXXX
LXXX 15.00/02/90F 4.5SN BK BX**

Weidmüller Interface GmbH & Co. KG
Klingenbergstraße 16
D-32758 Detmold
Germany
Fon: +49 5231 1429-0
Fax: +49 5231 14292083
www.weidmueller.com

Drawings

Dimensional drawing

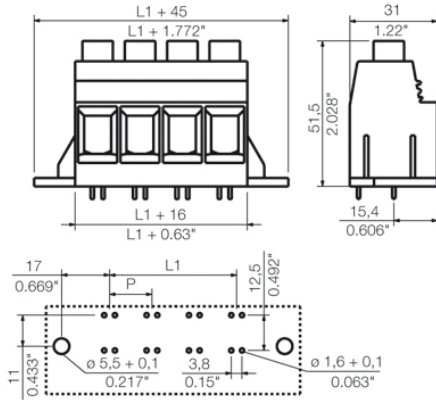

Graph

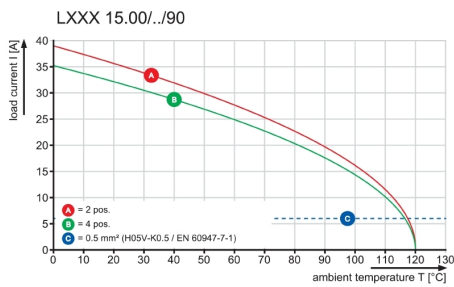

Graph

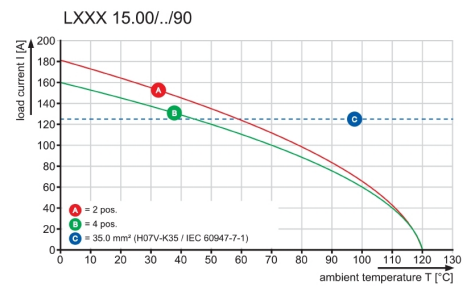

Graph

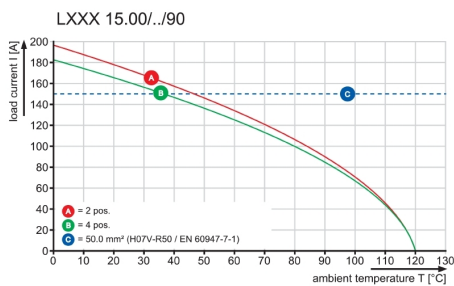

Recommended wave soldering profiles

Weidmüller Interface GmbH & Co. KG
 Klingenbergstraße 16
 D-32758 Detmold
 Germany
 Fon: +49 5231 14-0
 Fax: +49 5231 14-292083
 www.weidmueller.com

Single Wave:

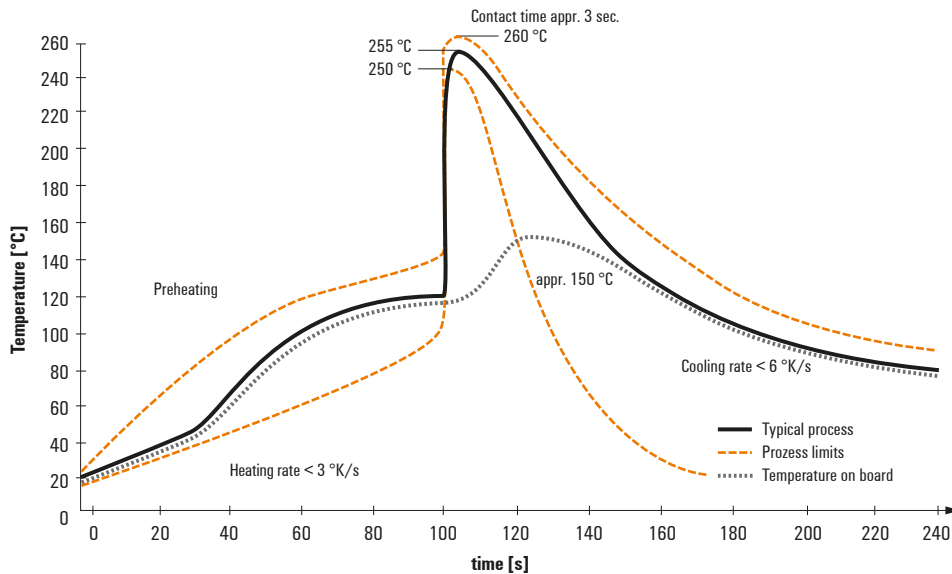

Double Wave:

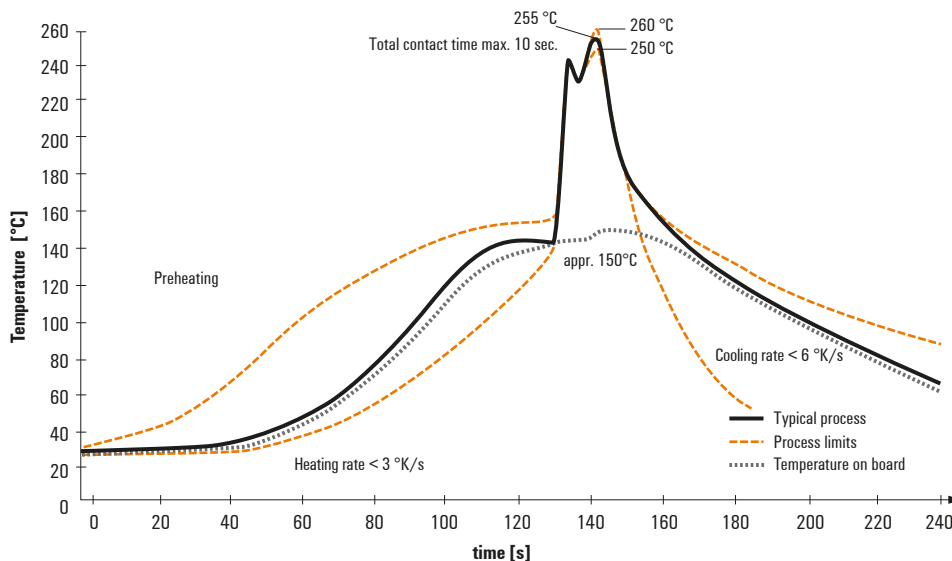

Wave soldering profiles

Wired connection elements should be processed in accordance with the DIN EN 61760-1 standard. We have included two recommendations for practical wave soldering profiles, with which Weidmüller PCB terminals and connectors are qualified.

When choosing a suitable profile for your application, the following factors also need to be considered:

- PCB thickness
- Proportion of Cu in the layers
- Single/double-sided assembly
- Product range
- Heating and cooling rates

The single and double wave profiles each indicate the recommended operating range, including the maximum soldering temperature of 260°C. In practice, the maximum soldering temperature is quite often well below the above maximum profile.

X-ON Electronics

Largest Supplier of Electrical and Electronic Components

Click to view similar products for [weidmuller](#) manufacturer:

Other Similar products are found below :

[8924550000](#) [56956](#) [0133660000](#) [6720000227](#) [6720005111](#) [68676](#) [69718](#) [EXO24CH](#) [7760056348](#) [7940000218](#) [8005181001](#) [8008180000](#)
[8432240000](#) [8463580000](#) [8545830000](#) [8689870000](#) [8705640000](#) [9001080000](#) [9003720000](#) [9004250000](#) [9004780000](#) [9013260000](#)
[9014100000](#) [9019040000](#) [9026010000](#) [9028630000](#) [903708](#) [9037350000](#) [9046290000](#) [9129643500](#) [913155](#) [9159530000](#) [919656](#) [919764](#)
[9202230000](#) [9202850000](#) [9456750000](#) [9457913000](#) [980811](#) [980826](#) [9912800003](#) [9916080000](#) [9916280012](#) [9918380000](#) [9919371205](#)
[9919371224](#) [9925710000](#) [9927480024](#) [1166660000](#) [11751](#)