

460-060  
to  
460-217

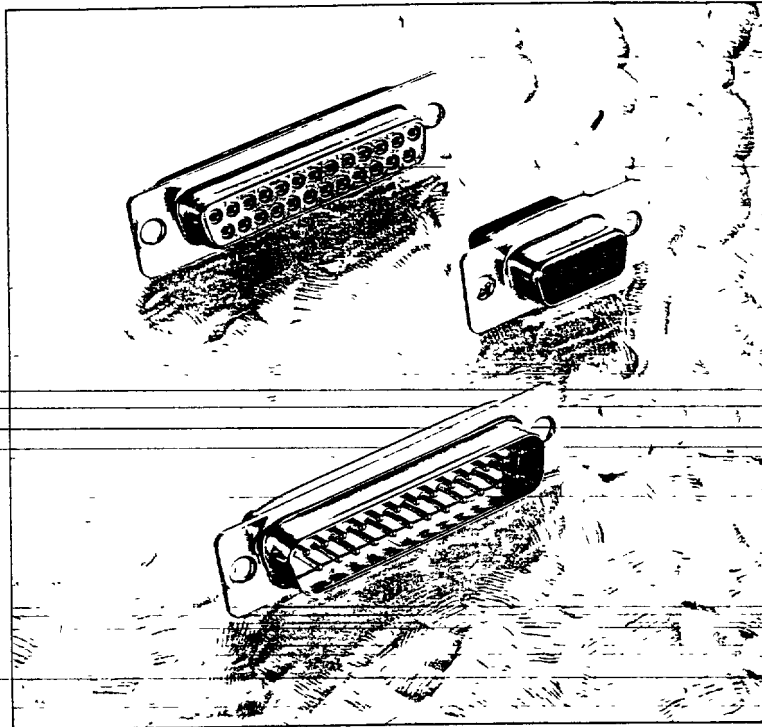

## D Subminiature Connectors

**CINCH**  
Cinch Connectors Ltd

Cinch Connectors forms part of the major worldwide engineering group Labinal, which was created in 1958 by the merger of Labinal and Précision Mécanique. With headquarters at Saint-Quentin-en-Yvelines near Paris, Labinal is divided into seven divisions which manufacture a wide variety of components for the automotive, aerospace, defence and electronics industries.

Cinch Connectors was acquired by Labinal in 1987 and operates in international high tech industries where quality is paramount.

By controlling the complete manufacturing process in-house including product and tool design, design evaluation, metal finishing and assembly, Cinch ensures that important international specifications such as BS9000 and US MIL Specs are met.

This high quality performance allows Cinch to succeed in sophisticated market places such as telecommunications, computers and business equipment, instrumentation and controls, automotive and, increasingly, defence. The product range includes many dedicated designs for specific applications such as anti-magnetic connectors for the military and space fields.

Our comprehensive D Subminiature range comprises 9, 15, 25, 37, and 50 contacts, 'Double Density' up to 100 contacts and Spacesaver 'Density and a Half'. It includes 25 way connectors for standard interface RS232 and 17 combination layouts for high power and coaxial contacts. Also featured is our comprehensive range of filtered connectors.

Cinch D Subminiature Connectors are available for virtually all forms of termination. Not only wire wrap and crimp, insulation displacement and flow solder, but also hand solder.

This catalogue details the complete range of connectors in addition to accessories from locking mechanisms to hoods suitable for EMI/RFI screening requirements where compliance with FCC regulations is important, and a full range of application tooling.

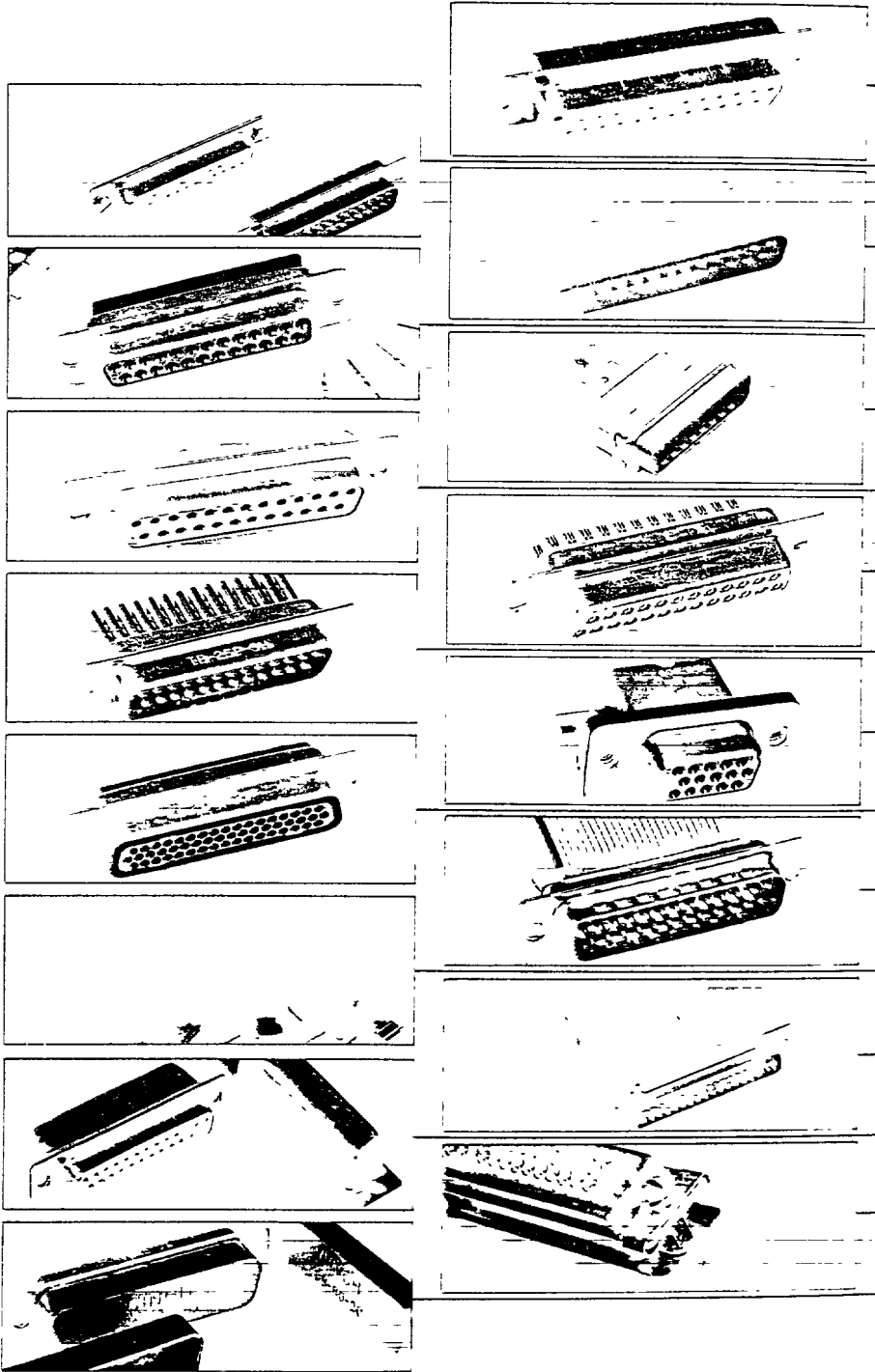

Page Nos

Technical Data

4 - 7

Technical Summary

8 - 9

Low Cost D

10 - 11

Standard D & BT 217

12 - 14

Series 1

15 - 18

Econo DA & Econo C

19 - 20

D-Subminiature Overmould Kit

21

Series 3

22 - 23

Filter D

24 - 25

Metal Shell IDC

26 - 27

Spacesaver HTD22 'Density and a Half'

28 - 30

Double Density - DURA-CON

31

Superfast IDC D

32

Accessories Selection Chart

33 - 34

Hoods & Cable Clamps

35 - 44

Switching Shells

44

Locking Mechanisms

45 - 46

Dust Caps

46

Termination Tooling

47 - 49

Contact Insertion & Extraction Tools

50 - 51

## Performance Specifications

All Cinch D Subminiature connectors have gold plated contacts with nickel underplating. The plating specifications have been carefully selected to provide a range of performance levels to suit every possible application.-

Performance Level	Performance	Comment
1	500 Matngs minimum followed by 21 day industrial atmosphere test and 21 day damp heat test to BS 2011	Exceeds DIN Class 2 as BT 217
2	100 Matngs minimum followed by 21 day damp heat test and 4 day industrial atmosphere test	Meets DIN Class 2
3	250 Matngs minimum followed by 21 day damp heat test at 93% relative humidity to BS 2011, Part 2 1 Ca Net contact resistance will not then exceed 5 milliohms	Exceeds DIN Class 3

## Termination Options

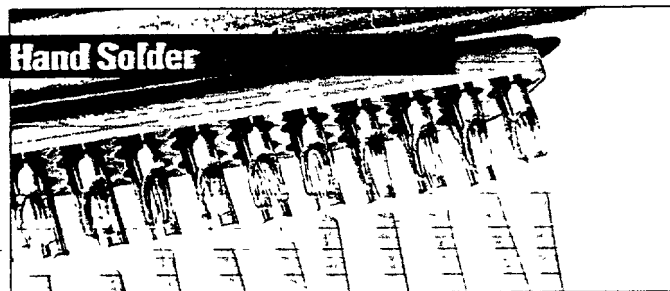

**Hand Solder**

### Standard D, Low Cost D, BS 9523 F0013, MIL-C-24308

- A universal termination system
- Low capital outlay – uses existing soldering equipment

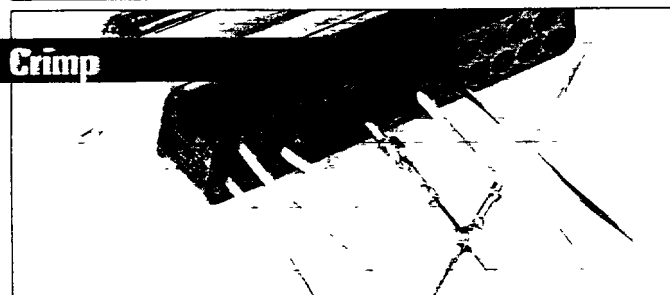

**Crimp**

### Econo DA & C, Series 3, Double Density, Space Saver

- Avoids the risks associated with soldering – overheating, flux damage
- Consistent high quality crimps achieved using automatic termination equipment
- Wide range of tooling available
- Alternative wire sizes are easily accommodated in the same housing
- Easy relocation of contacts within housings



**IDC - Discrete Wire**

### Metal Shell IDC

- Four point IDC contact
- Separate insulator grip
- Contacts may be re-terminated using hand tooling
- Ideal for high speed high volume production
- Semi or fully-automatic termination equipment

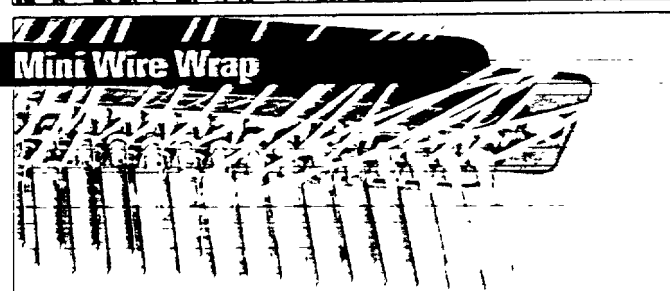

**Mini Wire Wrap**

### Standard D

- Uses standard mini-wrap system
- Accepts up to 3 mini-wraps per contact

## Shell Finishes

The traditional finish for D connector shells is zinc plating with a yellow chromate passivation.

However, to meet the requirements of FCC Docket 20780, VDE NORM 0871 and BS 6527 the mated connector shells need to make positive electrical contact. This is achieved by

grounding indents on the plug shells and by plating the shells with bright tin.

Alternative shell finishes and materials are available e.g. nickel plated mild steel and gold plated brass. Please contact sales office for specific requirements.

## Contact Arrangements

Cinch offer 32 different contact arrangements within the standard D Subminiature shells. Below are the 5 original arrangements:

In addition there are:- Double Density (see page 31). Space Saver 'Density and a Half' (see page 28) & Series 1 Combination Layouts (see page 18).

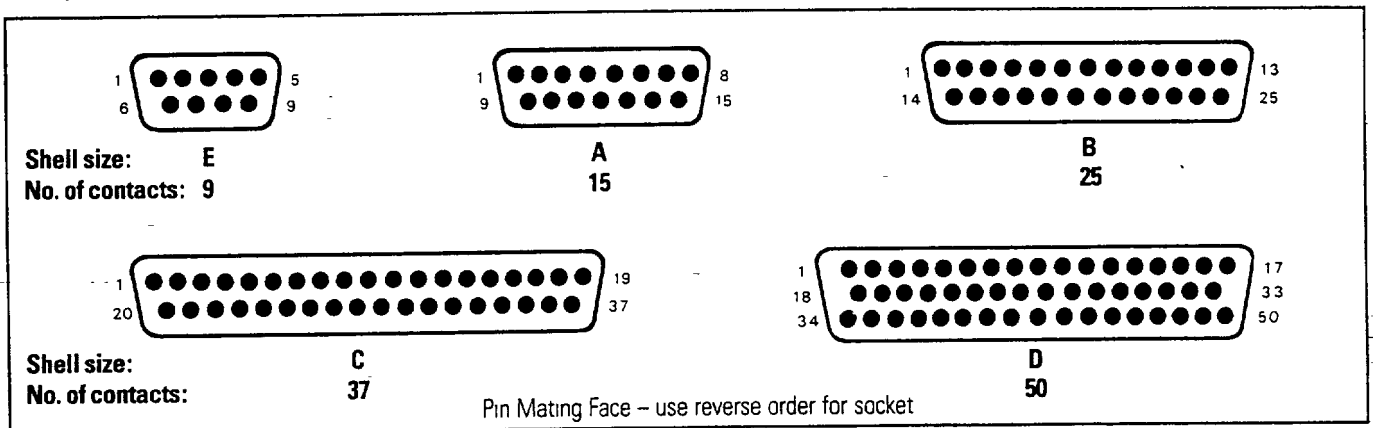

## Termination Options

### IDC – Flat Cable

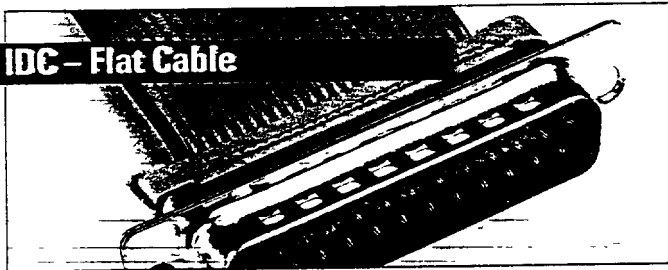

### Superfast IDC D

- High speed mass termination
- Low profile
- Supplied complete with strain relief
- Cover with jack screws available
- Metal shell for EMI/RFI screening and maximum strength

### Printed Circuit Board Mounting

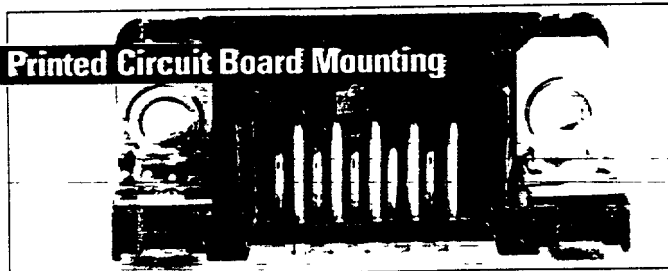

### Standard D, Low Cost D, Spacesaver, MIL-C-24308

- Easily mounted on the board
- Flow solderable
- All contacts terminated in one operation
- Right angle versions can be supplied with metal or plastic mounting brackets
- European and North American footprints
- Earthing straps and threaded riv-nuts available as standard

## Dimensions for Metal Shell D Connectors

**Hand Solder**

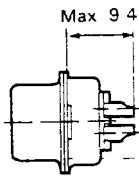

**Straight PCB Mounting**

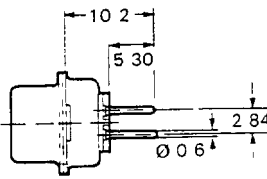

**Wire Wrap**

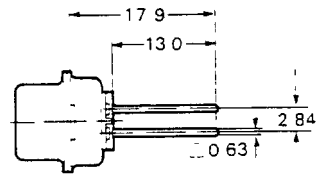

### 90° Printed Circuit Board Mounting

**With Plastic Brackets**

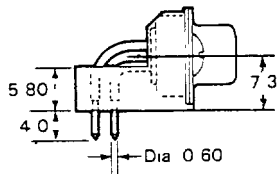

**With Metal Brackets**

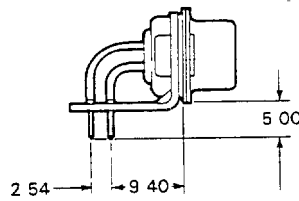

**With Plastic Brackets & Keeper Moulding**

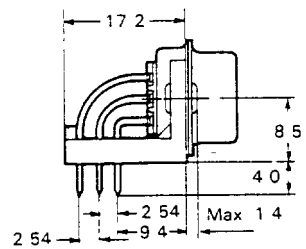
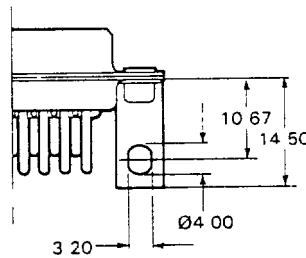
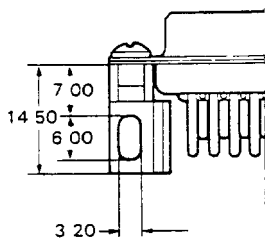
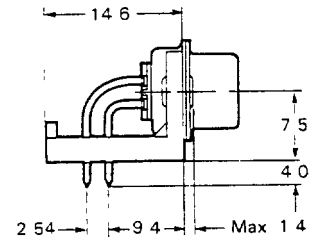

**50 Way**

**Float Mount**

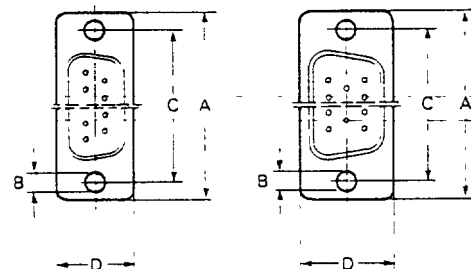
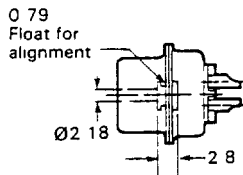

Number of Contacts	Dimensions (mm)			
	A±0.38	B±0.13	C±0.12	D±0.38
9	30.81	3.05	24.99	12.55
15	39.14	3.05	33.32	12.55
25	53.04	3.05	47.04	12.55
37	69.32	3.05	63.50	12.55
50	66.93	3.05	61.11	15.37

## PCB Mounting Details

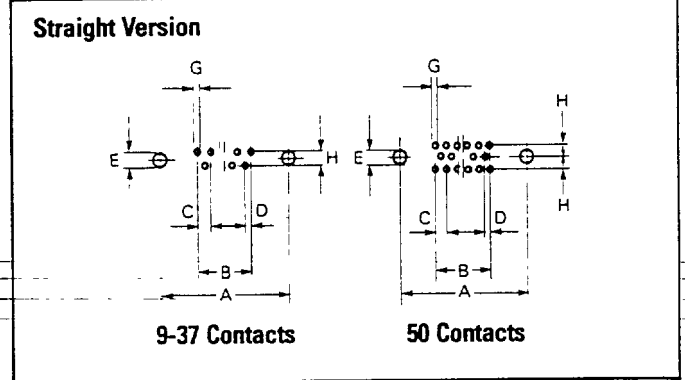
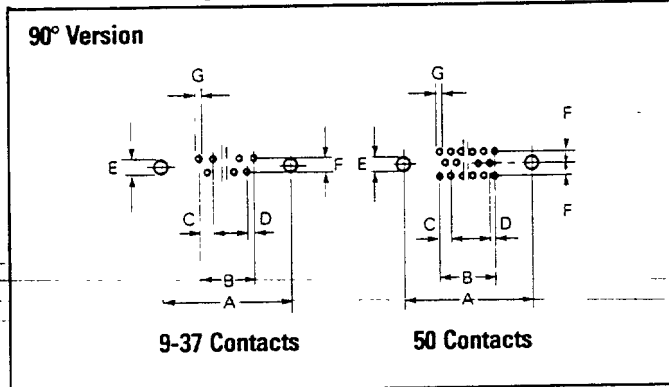

Number of Contacts	Dimensions (mm)							
	A $\pm 0.1$	B	C	D	E	F $\pm 0.05$	G min	H $\pm 0.05$
9	24.99	11.04	2.76	1.38	3.20	2.54	0.90	2.84
15	33.32	19.32	2.76	1.38	3.20	2.54	0.90	2.84
25	47.04	33.12	2.76	1.38	3.20	2.54	0.90	2.84
37	63.50	49.68	2.76	1.38	3.20	2.54	0.90	2.84
50	61.11	44.16	2.76	1.38	3.20	2.54	0.90	2.84

## Mating Details

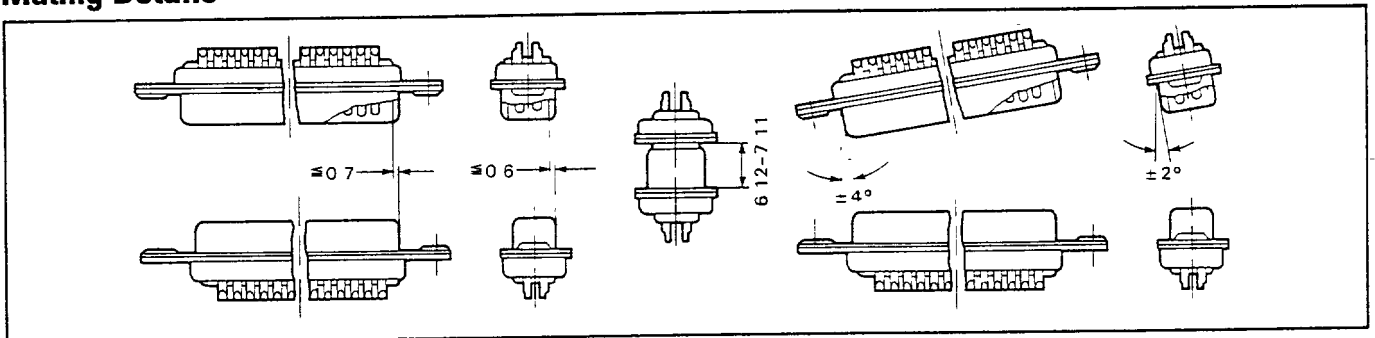



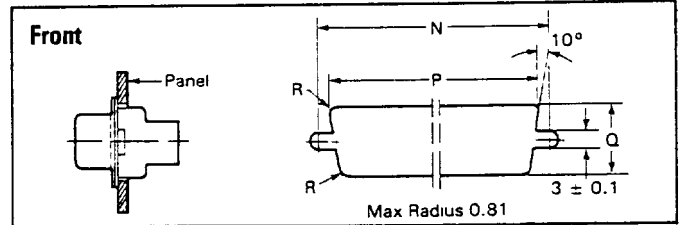
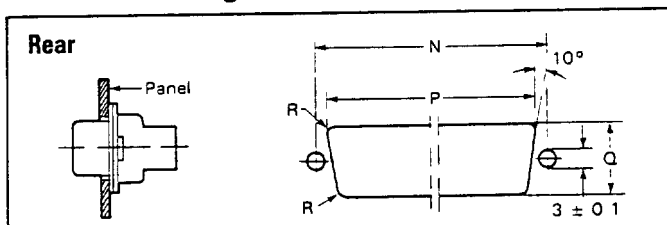

## Panel Mounting



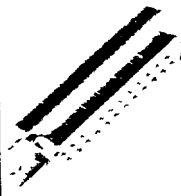

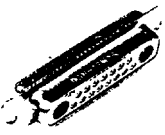

Number of Contacts	Dimensions (mm)					
	N $\pm 0.2$	P( $\pm 0.2$ ) Std	Float Mount	Q( $\pm 0.2$ ) Std	Float Mount	R( $\pm 0.2$ )
9	24.99	20.32	21.16	11.30	12.09	3.50
15	33.32	28.70	29.49	11.30	12.09	3.50
25	47.04	42.42	43.20	11.30	12.09	3.50
37	63.50	58.93	59.77	11.30	12.09	3.50
50	61.11	56.26	57.02	13.97	14.78	3.50

Number of Contacts	Dimensions (mm)					
	N $\pm 0.2$	P( $\pm 0.2$ ) Std	Float Mount	Q( $\pm 0.2$ ) Std	Float Mount	R( $\pm 0.2$ )
9	24.99	22.07	22.88	12.90	13.71	2.25
15	33.32	30.40	31.22	12.90	13.71	2.25
25	47.04	44.14	44.96	12.90	13.71	2.25
37	63.50	60.60	61.42	12.90	13.71	2.25
50	61.11	58.21	59.44	15.69	16.51	2.25

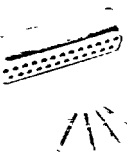
					
Type	Low Cost D	Standard D	Series 1, Pattern 110, BS9523 F0013	Econo D A	Econo C
See Page	10	12	15	19	19
Termination Options	Hand Solder Flow Solder	Hand Solder, Flow Solder, Wire Wrap	Hand Solder Flow Solder	Crimp with insulation grip	Crimp
Contact Arrangements	9 15 25 37 50	9 15 25 37 50	9 15 25 37 50 Plus Combination Layouts	9 15 25 37 50	9 15 25 37 50
Maximum Insertion/ Withdrawal Force	30, 50, 83, 123, 167N	30,50,83,123,167N	30,50,83,123,167N	30,50,83,123,167N	30,50,83,123,167N
Performance Classification	2 or 3	1, 2 or 3	BS9523 F0013 or MIL-C-24308	1,2 or 3	2 or 3
Wire Accommodation	≤0.5mm <sup>2</sup> (20 AWG)	≤0.5mm <sup>2</sup> (20 AWG)	≤0.5mm <sup>2</sup> (20 AWG)	20-28 AWG	20-28 AWG
Plug Contact Material	Copper Alloy	Copper Alloy	Copper Alloy	Copper Alloy	Copper Alloy
Socket Contact Material	Copper Alloy	Copper Alloy	Copper Alloy with Stainless Steel Sleeve	Copper Alloy	Copper Alloy
Current Rating	5A	7.5A	5A	5A	5A
Proof Voltage	1.05Kv d.c. or a.c. peak	2.5Kv d.c. or a.c. peak	2.5Kv d.c. or a.c. peak	-	-
Withstanding Voltage	-	-	1.25 Kv a.c. rms	1000 V a.c. rms	1000 V a.c. rms
Working Voltage	350V d.c. or a.c. peak	750V d.c. or a.c. peak	750V d.c. or a.c. peak	-	-
Contact Resistance	5 × 10 <sup>-3</sup> Ω max	5 × 10 <sup>-3</sup> Ω max	5 × 10 <sup>-3</sup> Ω max	5 × 10 <sup>-3</sup> Ω max	2.7 × 10 <sup>-3</sup> Ω max
Insulation Resistance	≥ 5 × 10 <sup>9</sup> Ω	≥ 5 × 10 <sup>9</sup> Ω	≥ 5 × 10 <sup>9</sup> Ω	≥ 1 × 10 <sup>9</sup> Ω	≥ 5 × 10 <sup>9</sup> Ω
Insulator Material	GF Polyester or PPS UL 94V-0 Rated	GF Polyester UL 94V-0 Rated	GF Diallyl Phthalate Green UL 94V-0 Rated	GF Nylon UL 94V-0 Rated	GF Nylon UL 94V-0 Rated
Shell Materials	Steel-zinc plated with yellow chromate passivation or bright tin finish with grounding indents on plugs	Steel-zinc plated with yellow chromate passivation or bright tin finish with grounding indents on plugs	Steel or brass with tin, zinc, gold or cadmium plating	Steel-zinc plated with yellow chromate passivation or bright tin finish with grounding indents on plugs	Steel-zinc plated with yellow chromate passivation or bright tin finish with grounding indents on plugs
Temperature Range C	-55 to +125	-55 to +125	-55 to -125	-55 to -125	-55 to -125

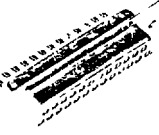

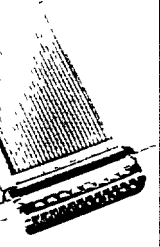
					
Series 3	Double Density DURA-CON	Filter D	Metal Shell IDC	Spacesaver HTD22	Superfast IDC D
22	31	24	26	28	32
Crimp	Crimp	Solder Bucket Flow Solder Straight or 90°	IDC (Individual Wires)	Crimp, Hand Solder Flow Solder	IDC (Flat Cable)
9 15 25 37 50	19 31 52 79 100	9,15,25,37,50	9 15 25 37	15 26 44 62 78	9 15 25 37
30, 50, 83, 123, 167N	40, 71, 119, 180, 228N	30,50,83,123,167N	30, 50, 83, 123N	45, 76, 125, 174, 218	30, 50, 83,123N
MIL-C-24308	2	1,2 or 3	3	1,2 or 3	2 or 3
20-24 AWG	22-26 AWG	50.5mm <sup>2</sup> (20AWG)	24-26 AWG	22-32 AWG	26-28 AWG
Copper Alloy	Copper Alloy	Copper Alloy	Copper Alloy	Copper Alloy	Beryllium Copper
Copper Alloy with Stainless Steel Sleeve	Copper Alloy	Copper Alloy	Copper Alloy	Copper Alloy	Beryllium Copper
5A	5A	5A	3A	5A	1A
-	-	500V d.c.	-	1.05 Kv d.c. or a.c. peak	1.05 Kv d.c. or a.c. peak
1.25 Kv a.c. rms	900 V a.c. rms	500V d.c.	1000 V a.c. rms	-	-
-	-	200V d.c. or ac peak	-	350V d.c. or a.c. peak	350V d.c. or a.c. peak
2.7 x 10 <sup>3</sup> Ω max	9 x 10 <sup>3</sup> Ω max	5x10 <sup>3</sup> Ω max	5 x 10 <sup>3</sup> Ω max	12 x 10 <sup>3</sup> Ω max	15 x 10 <sup>3</sup> Ω max
≥ 5 x 10 <sup>4</sup> Ω	≥ 5 x 10 <sup>4</sup> Ω	≥ 5 x 10 <sup>4</sup> Ω	≥ 5 x 10 <sup>4</sup> Ω	≥ 1 x 10 <sup>4</sup> Ω	≥ 1 x 10 <sup>4</sup> Ω
GF Drallyl Phthalate per MIL-M-14 UL 94V-0 Rated	GF Polyester UL 94V-0 Rated	G F Polyester UL94V-0 Rated	GF Polyester UL 94V-0 Rated	GF Nylon UL 94V-0 Rated	GF Polyester UL 94V-0 Rated
Steel or brass with bright tin, zinc, gold or cadmium plating	Steel-cadmium plated with yellow chromate passivation	Steel with nickel plated finish and grounding indents on plugs	Steel with bright tin finish and grounding indents on plugs	Steel-zinc plated with yellow chromate passivation or bright tin finish with grounding indents on plugs	Steel-zinc plated with yellow chromate passivation or bright tin finish with grounding indents on plugs
-55 to - 125	-55 to + 125	Application Specific	-55 to - 125	-55 to + 125	-55 to + 85 limited by PVC Insulation on Ribbon Cable



- Bright tin finish & grounding indents as standard
- UL 94V-0 rated insulators
- Compatible with other Cinch D Subminiatures
- Meets relevant dimensional requirements of MIL-C-24308, BS9523 F0013, DIN 41652 and BT 217.
- Screw locks, snap feet & earthing straps supplied as standard on 90° PCB mount versions

**Hand Solder**

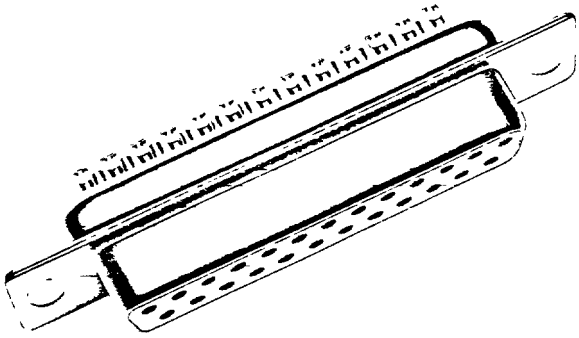

**Hand Solder**

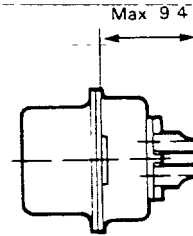

**Straight PCB Mounting**

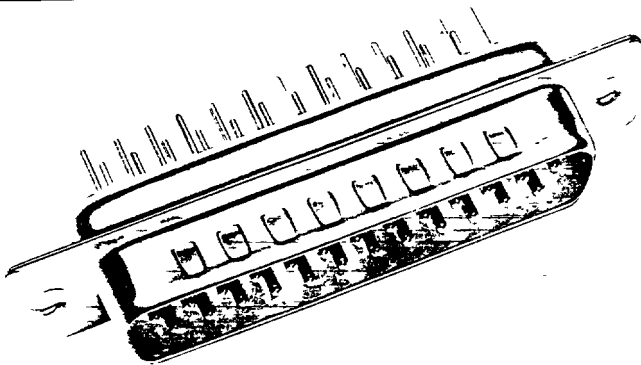

**Straight PCB Mounting**

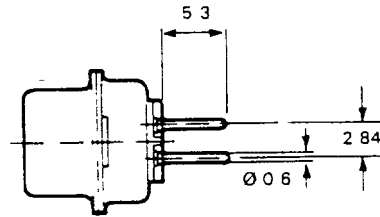

**90° PCB Mounting**

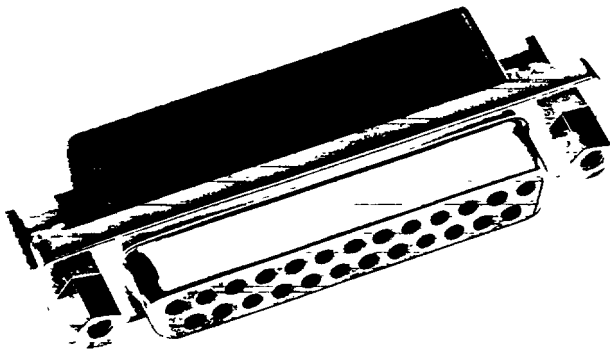

**90° PCB mounting**

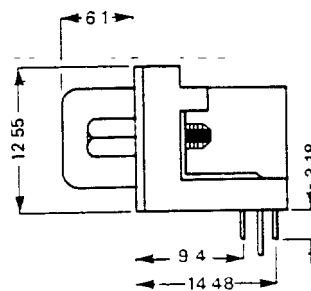

## Technical Data

<b>Termination Options</b>	Solder Bucket, Flow Solder Straight & 90°				
<b>Number of Contacts</b>	9	15	25	37	50
<b>Maximum Insertion &amp; Extraction Force</b>	30	50	83	123	167N
<b>Performance Level</b>	3				
<b>Wire Accommodation</b>	≤0.5mm <sup>2</sup> (20 AWG)				
<b>Plug Contact Material</b>	Copper Alloy				
<b>Socket Contact Material</b>	Copper Alloy				

<b>Current Rating</b>	5A
<b>Proof Voltage</b>	1.05 Kv d.c. or a.c. peak
<b>Working Voltage</b>	350V d.c. or a.c. peak
<b>Contact Resistance</b>	5 x 10 <sup>-3</sup> Ω max
<b>Insulation Resistance</b>	≥5 x 10 <sup>8</sup> Ω
<b>Temperature Range</b>	-55°C to +125°C
<b>Insulator Materials</b>	GF Polyester. UL 94V-0 Rated
<b>Shell Materials</b>	Steel - zinc plated or bright tin finish with grounding indents on plugs

## Part Numbering

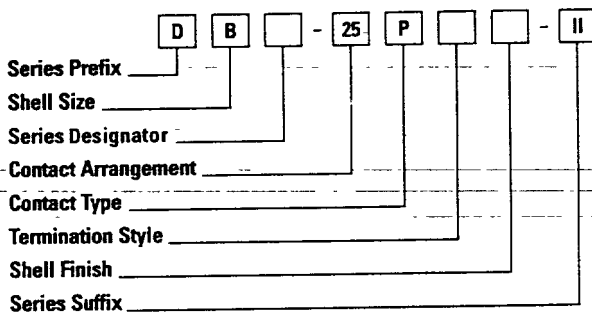

<b>Series Prefix</b>	<b>D</b>
<b>Shell Size</b>	<b>E, A, B, C or D</b>
<b>Series Designator</b>	<b>LD</b> -90° PCB Mount Only
<b>Contact Arrangement</b>	<b>9, 15, 25, 37 or 50</b>
	-50 way available in solder bucket and straight PCB mounting only
<b>Contact Type</b>	<b>P or S</b>
<b>Termination Style</b>	<b>1ASN</b> -90° PCB mounting with bracket, snap-in board locks and earthing straps
	<b>OL2</b> -Straight PCB mounting
	<b>No designation</b> -Solder bucket
<b>Shell Finish</b>	<b>T</b> -Bright tin
	<b>TI</b> -Bright tin with grounding indents (plugs only)
	<b>No designation</b> -Zinc plated with yellow chromate passivation
<b>Series Suffix</b>	<b>II</b> -Solder bucket & straight PCB mount only

### Solder Backed

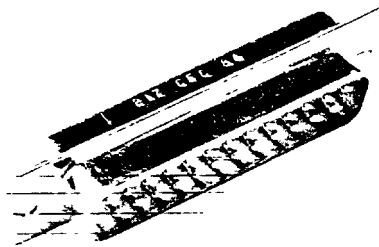

- Performance as BT 217. For approved version see page 14
- Conforms to BS 9523 F0010 and F0018
- Standard RS232 interface
- Bright tin finish & grounding indents available for EMI/RFI shielding
- Meets dimensional requirements of MIL-C-24308, BS9523 F0018 & DIN 41652
- UL 94V-0 rated insulators
- Compatible with all other D Subminiatures

### Straight PCB Mount

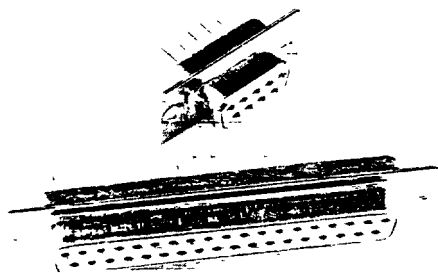

### 90° PCB Mounting

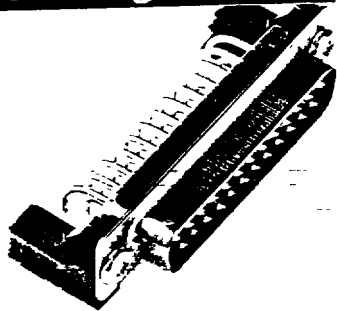

### Wire Wrap

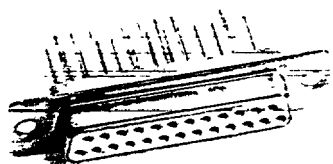

## Technical Data

<b>Termination Options</b>	Solder Bucket Flow Solder Straight & 90° Wire Wrap
<b>Number of Contacts</b>	9 15 25 37 50
<b>Maximum Insertion &amp; Extraction Force</b>	30 50 83 123 167N
<b>Performance Level</b>	1, 2 or 3
<b>Wire Accommodation</b>	≤0.5mm <sup>2</sup> (20AWG)
<b>Plug Contact Material</b>	Copper Alloy
<b>Socket Contact Material</b>	Copper Alloy
<b>Current Rating</b>	7.5A

<b>Proof Voltage</b>	2.5 Kv d.c. or a.c. peak
<b>Working Voltage</b>	750V d.c. or a.c. peak
<b>Contact Resistance</b>	5 x 10 <sup>-4</sup> Ω max
<b>Insulation Resistance</b>	≥ 5 x 10 <sup>9</sup> Ω
<b>Temperature Range</b>	-55°C to +125°C
<b>Insulator Material</b>	GF Polyester, UL 94V-0 rated
<b>Shell Materials</b>	Steel—zinc plated or bright tin finish with grounding indents on plugs

## Part Numbering

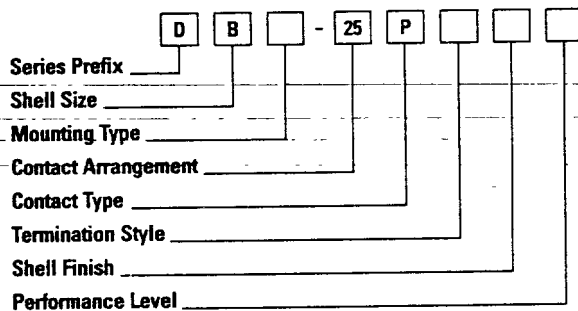

<b>Series Prefix</b>	<b>D</b>
<b>Shell Size</b>	<b>E, A, B, C or D</b>
<b>Mounting Type</b>	<b>B</b> - 4-40 riv-nut for rear panel mounting <b>P</b> - M3 riv-nut for rear panel mounting <b>D</b> - With female screw locks fitted <b>E</b> - 4-40 clinch-nut for rear panel mounting with locking feature for high vibration applications <b>F</b> - Float mount for rear panel mounting <b>Y</b> - Universal float mount <b>No designation</b> - Ø 3.05mm mounting hole 90° Flow Solder versions are not available with float mounts

<b>Contact Arrangement</b>	<b>9, 15, 25, 37 or 50</b>
<b>Contact Type</b>	<b>P or S</b>
<b>Termination Style</b>	<b>90° Flow Solder</b> <b>European Footprint</b>
	<b>1A0N</b> - Without brackets <b>1A1N</b> - With plastic brackets <b>1A2N</b> - With plastic brackets and keeper moulding <b>1A3N</b> - With metal mounting brackets* <b>1AEN</b> - With earthing straps on plastic brackets with keeper moulding* <b>1ASN</b> - With board locks, earthing straps, plastic bracket and keeper moulding*
	<b>For reverse orientation of contacts relative to shell, replace N with R.</b> <b>*Please specify riv-nuts or screw locks, mounting types B, P, or D</b> 50 Way 90° PCB mounting available as 1A0N and 1A2N only
<b>Straight Flow Solder</b>	<b>0L2</b> - Termination Ø 0.6mm, 5.3mm long
<b>90° Flow Solder</b>	<b>BL2</b> - Termination ø 0.6mm
<b>Mini Wire Wrap</b>	<b>F179A</b> - 0.61mm square section pins for up to 3 wraps
<b>Solder Bucket</b>	<b>No designation required</b>
<b>Shell Finish</b>	<b>T</b> - Bright tin <b>TI</b> - Bright tin with grounding indents (plugs only) <b>No designation</b> - Zinc plated with yellow chromate passivation
<b>Performance Level</b>	<b>2</b> - DIN Class 2 <b>1</b> - As BT217 <b>No designation</b> - Performance level 3

N.B For versions to U.S. standards, please consult Cinch Sales Office

## BT 217

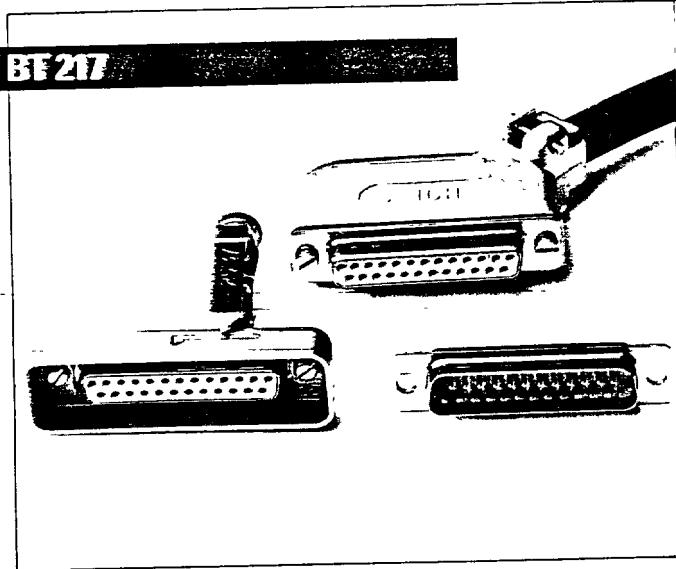

- BT specification D2399 pattern 217 has been the most widely used British specification for D Subminiature connectors since its introduction
- Fully approved connectors may be ordered to BT codes
- Ideal for applications involving industrial atmospheres and up to 500 mating cycles
- Connectors ordered to the part numbers below are supplied marked with the BT 217 code and full release is available

## Technical Data

<b>Termination Options</b>	Solder Bucket Flow Solder Straight & 90° Wire Wrap
<b>Number of Contacts</b>	9 15 25 37 50
<b>Maximum Insertion &amp; Extraction Force</b>	30 50 83 123 167N
<b>Performance Level</b>	1
<b>Wire Accommodation</b>	≤0.5mm <sup>2</sup> (20AWG)
<b>Plug Contact Material</b>	Copper Alloy
<b>Socket Contact Material</b>	Copper Alloy
<b>Current Rating</b>	5A

<b>Proof Voltage</b>	2.5 Kv d.c. or a.c. peak
<b>Working Voltage</b>	750V d.c. or a.c. peak
<b>Contact Resistance</b>	5 x 10 <sup>-3</sup> Ω max
<b>Insulation Resistance</b>	≥ 5 x 10 <sup>9</sup> Ω
<b>Temperature Range</b>	-55°C to +125°C
<b>Insulator Material</b>	GF Polyester, UL 94V-0 rated
<b>Shell Materials</b>	Steel - zinc plated with yellow chromate passivation

## Part Numbering

### Plugs

Number of Contacts	Solder Bucket Connector	Solder Bucket Connector with Die Cast Back Shell	Solder Bucket Connector with Base Retainer
9	217B09A	217A09A	217B09B
15	217B15A	217A15A	217B15B
25	217B25A	217A25A	217B25B
37	217B37A	217A37A	217B37B
50	217B50A	217A50A	217B50B

### Sockets

Number of Contacts	Solder Bucket Connector	Solder Bucket Connector with Die Cast Back Shell	Solder Bucket Connector with Base Retainer
9	217D09A	217C09A	217D09B
15	217D15A	217C15A	217D15B
25	217D25A	217C25A	217D25B
37	217D37A	217C37A	217D37B
50	217D50A	217C50A	217D50B

Note: - This specification requires connectors to be suitable for 500 mating cycles followed by a 21 day industrial atmosphere test. Contact resistance will not then exceed 5 milliohms. Conformance to this specification indicates that the connector will perform well in hazardous environments over very long periods.

### Solder Bucket

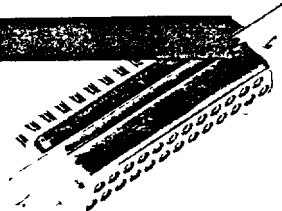

### Straight PCB Mounting

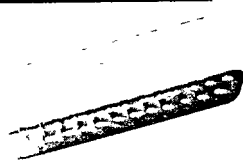

### 90° PCB Mounting

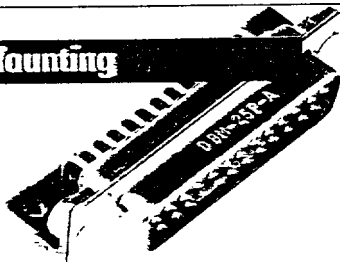

### Combination Layouts

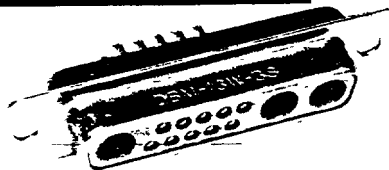

- Full release available to pattern 110, BS 9523 F0013 & MIL-C-24308
- Probe proof sleeved socket contacts
- Combination layouts with high voltage/high power/coaxial contacts
- Combination layouts are supplied with fixed solder bucket contacts
- Intermateable with other D Subminiatures
- Bright tin, zinc, gold or cadmium plating available on shells
- Low residual magnetism/high-reliability/space application versions available. Please consult factory
- EMI/RFI shielded versions available
- Environmentally-sealed versions available. Please contact factory for part numbers
- UL 94V-0 rated insulators

#### Termination Styles A & L

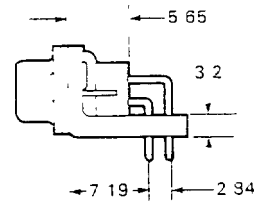

#### Termination Styles B & H

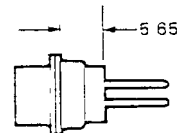

### Technical Data

<b>Termination Options</b>	Solder Bucket 90° Flow Solder Straight Flow Solder	
<b>Number of Contacts</b>	9 15 25 37 50	
<b>Maximum Insertion &amp; Extraction Force</b>	30 50 83 123 167N	
<b>Release Available</b>	Pattern 110 BS9523 F0013 MIL-C-24308	
<b>Wire Accommodation (Size 20 Contact)</b>	≤0.5mm <sup>2</sup> (20 AWG)	
<b>Plug Contact Material</b>	Copper Alloy	
<b>Socket Contact Material</b>	Copper Alloy with stainless steel sleeve	
<b>Current Rating</b>	5A	
<b>Proof Voltage</b>		2.5 Kv d.c. or a.c. peak
<b>Withstanding Voltage</b>		1.25 Kv a.c. rms
<b>Working Voltage</b>		750V d.c. or a.c. peak
<b>Contact Resistance</b>		5 x 10 <sup>-3</sup> Ω max
<b>Insulation Resistance</b>		≥ 5 x 10 <sup>9</sup> Ω
<b>Insulator Material</b>		GF Diallyl Phthalate Green UL 94V-0 rated
<b>Temperature Range</b>		-55°C to +125°C
<b>Shell Materials</b>		Steel:- BS9523 F0013 – zinc plated with yellow chromate passivation MIL-C-24308 – Cadmium plated with yellow chromate passivation. Bright tin finish is available as a commercial version of the BS style. For other versions, e.g. gold plated/brass non magnetic shells, please consult factory

For release to BS9523 F0013, please order to NATO stock numbers Class MM connectors will be supplied to

MIL-C-24308 performance levels. Please order to MIL-C-24308 part numbers if MIL specification release is required.

**Solder Bucket - Plugs**

Number of Contacts	Description	NATO Stock Number		MIL-C-24308	
		Normal Mounting	With Float Mounts	Normal Mounting	With Float Mounts
9	DEM9P	5935-99-014-1442	5935-99-014-7491	M24308/3-1	M24308/3-12
15	DAM15P	5935-99-014-1443	5935-99-014-7493	M24308/3-2	M24308/3-13
25	DBM25P	5935-99-014-1444	5935-99-014-7495	M24308/3-3	M24308/3-14
37	DCM37P	5935-99-014-1445	5935-99-014-7497	M24308/3-4	M24308/3-15
50	DDM50P	5935-99-014-1446	5935-99-014-7499	M24308/3-5	M24308/3-16

**Solder Bucket - Sockets**

Number of Contacts	Description	NATO Stock Number		MIL-C-24308	
		Normal Mounting	With Float Mounts	Normal Mounting	With Float Mounts
9	DEM9S	5935-99-014-9583	5935-99-014-7492	M24308/1-1	M24308/1-12
15	DAM15S	5935-99-014-9585	5935-99-014-7494	M24308/1-2	M24308/1-13
25	DBM25S	5935-99-014-9587	5935-99-014-7496	M24308/1-3	M24308/1-14
37	DCM37S	5935-99-014-9589	5935-99-014-7498	M24308/1-4	M24308/1-15
50	DDM50S	5935-99-014-9591	5935-99-014-7500	M24308/1-5	M24308/1-16

**PCB Mounting - Plugs and Sockets**



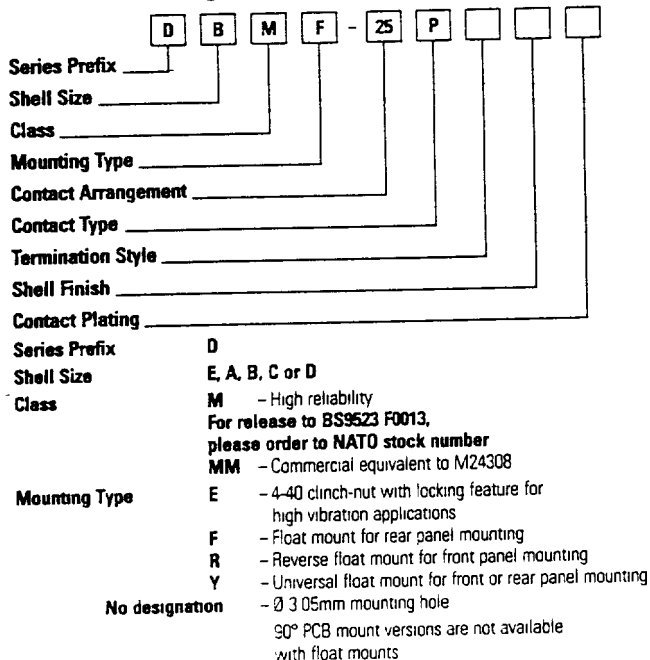

Number of Contacts	90° Flow Solder Tails		Straight Flow Solder Tails		
	Plugs to MIL-C-24308		Plugs and Sockets to MIL-C-24308		
	2.36mm Tail Length 0.76mm Diameter	2.36mm Tail Length 1.02mm Diameter	3.96mm Tail Length 0.76 Diameter		4.67mm Tail Length 0.76 Diameter
			Plugs	Sockets	Sockets
9	M24308/24-25	M24308/24-37	M24308/24-1	M24308/23-1	M24308/23-7
15	M24308/24-26	M24308/24-38	M24308/24-2	M24308/23-2	M24308/23-8
25	M24308/24-27	M24308/24-39	M24308/24-3	M24308/23-3	M24308/23-9
37	M24308/24-28	M24308/24-40	M24308/24-4	M24308/23-4	M24308/23-10
50	-	-	M24308/24-5	M24308/23-5	M24308/23-11

**Part Numbering**



- Contact Arrangement** 9, 15, 25, 37 or 50  
 5W1, 3W3, 7W2, 11W1, 9W4, 13W3, 17W2, 21W1, 13W6, 8W8, 17W5, 21W4A, 25W3, 27W2, 24W7, 36W4, 43W2
- Contact Type** P or S
- Termination Style**  
 90° Flow Solder  
**1A2N** - European Footprint with 30° mounting bracket and keeper moulding  
**A** - 2.63mm tail length U.S. footprint  
 9, 15, 25 & 37 way available  
**L** - 3.96mm tail length  
 9, 15, 25 & 37 way plugs available
- Straight Flow Solder**  
**OL3** - European standard Ø 0.76mm, 4mm long  
**B** - U.S. standard Ø 1mm, 3.18mm long  
**H** - U.S. standard Ø 1mm, 3.96mm long
- Solder Bucket**  
**No designation required**  
 Combination layouts available with solder buckets. For other termination styles, please consult Sales Office
- Shell Finish**  
**T** - Bright tin  
**TI** - Bright tin with grounding indents (plugs only) (not applicable for Series MM)  
**No designation** - Zinc plated with yellow chromate passivation  
 Class MM - Cadmium plated with yellow chromate passivation  
 For gold plated brass, non-magnetic shells, please consult Sales Office
- Contact Plating** A156  
**No designation** - 1.25µ gold (standard for Series MM)  
 - Standard plating - 0.75µ gold

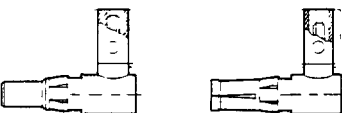
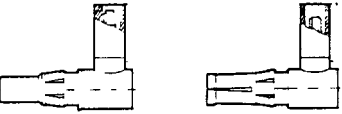
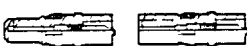

Plug	Socket	Part Number Standard Finish	Part Number Military Finish	Use with R.G. Cable or Equivalent	
<b>Straight Crimp Braid Coax Contacts</b> 		Plug	DM53740	DM53740-17	178B/U
		Plug	DM53740-1	DM53740-15	179B/U
		Plug	DM53740-3	DM53740-16	180B/U
		Plug	DM53740-5	DM53740-18	58B/U
		Socket	DM53742	DM53742-18	178B/U
		Socket	DM53742-1	DM53742-16	179B/U
		Socket	DM58742-3	DM53742-17	180B/U
		Socket	DM53742-5	DM53742-19	58B/U
<b>Straight Solder Braid Coax Contacts</b> 		Plug	DM53740-5008	DM53740-5105	178B/U
		Plug	DM53740-5001	DM53740-5099	179B/U
		Plug	DM53740-5002	DM53740-5104	180B/U
		Plug	DM53740-5005	DM53740-5101	58B/U
		Socket	DM53742-5006	DM53742-5092	178B/U
		Socket	DM53742-5001	DM53742-5089	179B/U
		Socket	DM53742-5002	DM53742-5091	180B/U
		Socket	DM53742-5004	DM53742-5086	58B/U
		Plug (Short)	DM53740-5000	DM53740-5100	178B/U
Socket (Short)	DM53742-5000	DM53742-5085	178B/U		
<b>Right Angle Crimp Braid Contacts</b> 		Plug	DM53741	DM53741-12	178B/U
		Plug	DM53741-1	DM53741-11	179B/U
		Plug	DM53741-3	DM53741-10	180B/U
		Plug	DM53741-4	DM53741-13	58B/U
		Socket	DM53743-2	DM53743-18	178B/U
		Socket	DM53743-3	DM53743-16	179B/U
		Socket	DM53743-5	DM53743-17	180B/U
		Socket	DM53743-6	DM53743-19	58B/U
<b>Right Angle Solder Braid Coax Contacts</b> 		Plug	DM53741-5000	DM53741-5059	178B/U
		Plug	DM53741-5001	DM53741-5062	179B/U
		Plug	DM53741-5003	DM53741-5063	180B/U
		Plug	DM53741-5004	DM53741-5060	58B/U
		Socket	DM53743-5000	DM53743-5073	178B/U
		Socket	DM53743-5001	DM53743-5076	179B/U
		Socket	DM53743-5003	DM53743-5077	180B/U
		Socket	DM53743-5004	DM53743-5074	58B/U
<b>Straight High Voltage Contacts</b> 					Wire Size AWG
		Plug	DM51157	DM51157-8	# 20
<b>High Power Solder Contacts</b> 		Socket	DM51155	DM51155-7	# 20
		Plug - 40 amp	DM53745-1	DM53745-28	# 8
		Plug - 20 amp	DM53745-7	DM53745-27	# 12
		Plug - 10 amp	DM53745-8	DM53745-25	# 16
		Socket - 40 amp	DM53744-1	DM53744-21	# 8
		Socket - 20 amp	DM53744-6	DM53744-25	# 12
Socket - 10 amp	DM53744-24	DM53744-24	# 16		

## Combination Layouts:- Coaxial, High Voltage, High Power & Solder Bucket



**E**  
DEM-5W1P  
DEM-5W1S

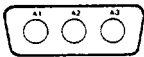

**A**  
DAM-3W3P  
DAM-3W3S



**A**  
DAM-7W2P  
DAM-7W2S



**A**  
DAM-11W1P  
DAM-11W1S



**B**  
DBM-9W4P  
DBM-9W4S

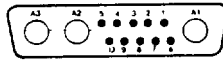

**B**  
DBM-13W3P  
DBM-13W3S

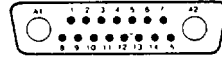

**B**  
DBM-17W2P  
DBM-17W2S



**B**  
DBM-21W1P  
DBM-21W1S

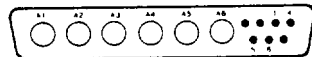

**C**  
DCM-13W6P  
DCM-13W6S

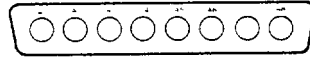

**C**  
DCM-8W8P  
DCM-8W8S

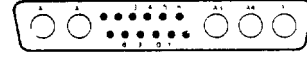

**C**  
DCM-17W5P  
DCM-17W5S

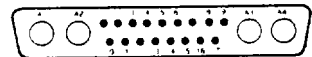

**C**  
DCM-21WA4P  
DCM-21WA4S

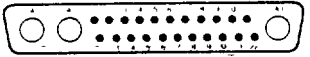

**C**  
DCM-25W3P  
DCM-25W3S



**C**  
DCM-27W2P  
DCM-27W2S

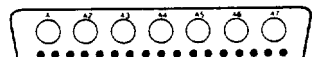

**D**  
DDM-24W7P  
DDM-24W7S

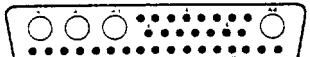

**D**  
DDM-36W4P  
DDM-36W4S

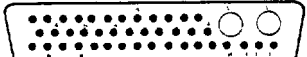

**D**  
DDM-43W2P  
DDM-43W2S

## Econo DA

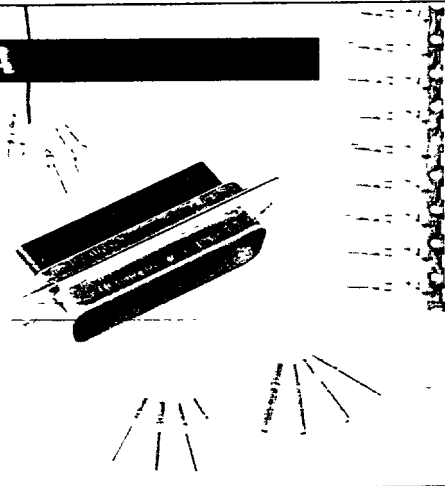

- High speed automatic termination
- Low cost
- UL 94V-0 rated insulator materials
- Part loading by user guarantees total flexibility
- Contacts available in a range of performance levels
- A full range of termination tooling is available (see page 47)
- Automatic stripping/crimping eliminates the variability of hand soldering
- Econo DA offers the security of insulation grip contacts
- Econo C has low-profile rear insulator
- Contacts are removable and replaceable

## Econo C

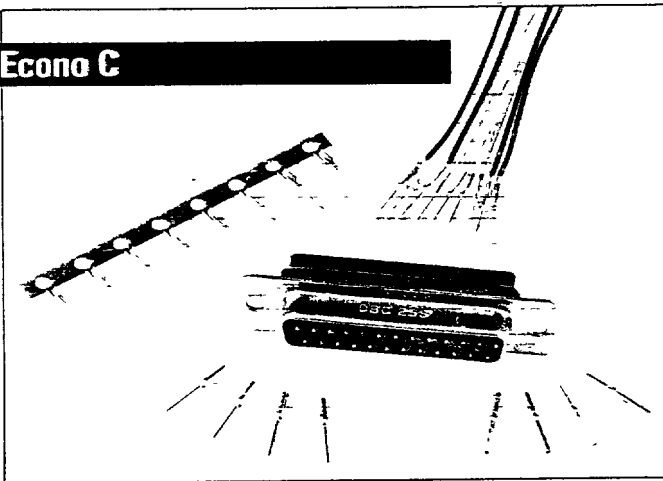

### Econo DA

Contacts supplied on reels for high speed crimping

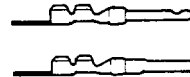

Housings

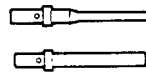
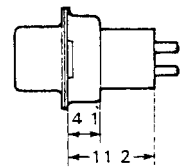

Machined contacts for higher reliability applications

Socket contacts have stainless steel sleeves to prevent damage by probes

### Econo C

Contacts supplied on reels for high speed crimping

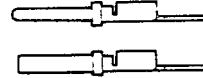

Housings

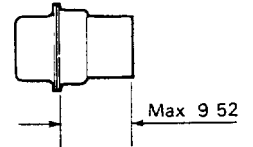

Machined contacts

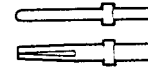

## Technical Data

	Econo DA					Econo C				
Termination Style	Crimp with insulation grip					Crimp				
Number of Contacts	9	15	25	37	50	9	15	25	37	50
Maximum Insertion & Extraction Force	30	50	83	123	167N	30	50	83	123	167N
Performance Levels	1, 2 or 3					2 or 3				
Wire Accommodation	20-28 AWG					20-28 AWG				
Socket Contact Material	Copper Alloy					Copper Alloy				
Plug Contact Material	Copper Alloy					Copper Alloy				
Current Rating	5A					5A				
Withstanding Voltage	1000V a.c. rms					1000V a.c. rms				
Insulation Resistance	$\geq 1 \times 10^8 \Omega$					$\geq 5 \times 10^8 \Omega$				
Contact Resistance	$5 \times 10^{-3} \Omega$ max					$2.7 \times 10^{-3} \Omega$ max				
Operating Temperature	-55°C to +125°C					-55°C to +125°C				
Insulator Material	GF Nylon UL94V-0 rated					GF Nylon UL94V-0 rated				
Shell Materials	Steel - zinc plated or bright tin finish with grounding indents on plugs					Steel - zinc plated or bright tin finish with grounding indents on plugs				

### Econo DA Contacts

Version	Performance Level	Pin Contacts	Socket Contacts
15,000 Reels 20 - 24 AWG	3	RO6 00003 RH 000 GFA	RO6 00004 RH 000 GFA
15,000 Reels 24 - 28 AWG	3	RO6 00001 RH 000 GFA	RO6 00002 RH 000 GFA
300 Reels 20 - 24 AWG	3	RO6 00003 RC 300 GFA	RO6 00004 RC 300 GFA
300 Reels 24 - 28 AWG	3	RO6 00001 RC 300 GFA	RO6 00002 RC 300 GFA
Strips of 10 Contacts 20-24	3	RO6 00017 00 000 GFA	RO6 00018 00 000 GFA
Series 3 Commercial (turned)	3	330-5291-000	031-1007-000
Series 3 to MIL-C-24308 (turned)	Military	M39029/64-369	M39029/63-368

For additional plating variations please contact the factory

### Econo C Contacts

Description	Machined Contacts For 20 - 24 AWG	Stamped Contacts on Reels Performance Level 3	Stamped Contacts on Reels Performance Level 2	Stamped Contacts Supplied Loose
Pin	030-1952-000	BCL-1964-20P	D110238-034	030-1960-005
Socket	030-1953-000	BCL-1963-20S	D110238-035	030-1957-005

### Part Numbering

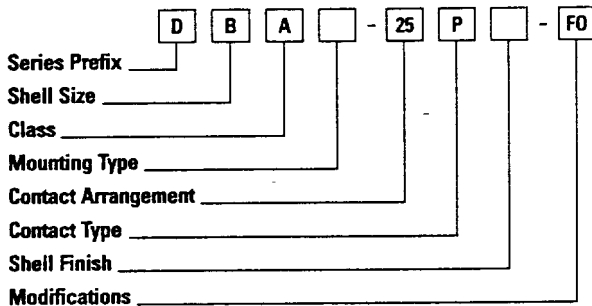

<b>Series Prefix</b>	<b>D</b>
<b>Shell Size</b>	<b>E, A, B, C or D</b>
<b>Class</b>	<b>A</b> - Econo DA <b>U</b> - Econo C
<b>Mounting Type</b>	<b>B</b> - 4-40 riv-nut for rear panel mounting <b>P</b> - M3 riv-nut for rear panel mounting <b>Y</b> - Universal float mount for front or rear panel mounting <b>No designation</b> - Ø 3.05mm mounting hole
<b>Contact Arrangement</b>	<b>9, 15, 25, 37 or 50</b>
<b>Contact Type</b>	<b>P or S</b>
<b>Shell Finish</b>	<b>T</b> - Bright tin <b>TI</b> - Bright tin with grounding indents (plugs only) <b>No designation</b> - Zinc plating with yellow chromate passivation
<b>Modifications</b>	<b>FO</b> - Supplied without contacts (The modification code is not marked on the connector) <b>No designation</b> - Supplied with machined contacts (Econo C only)

## Overmouldable Shielding Kit

### Plug

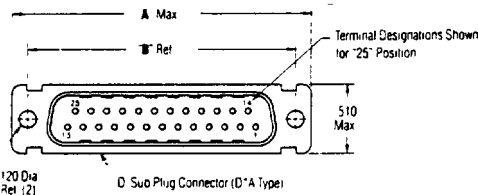
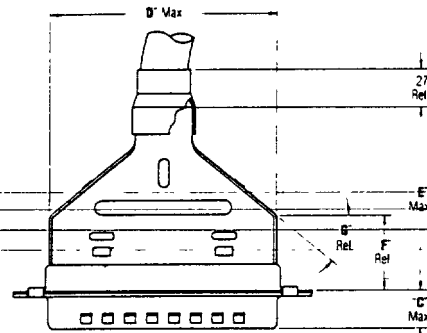

120 Dia Ref (2)  
D Sub Plug Connector (D'A Type)

### Socket

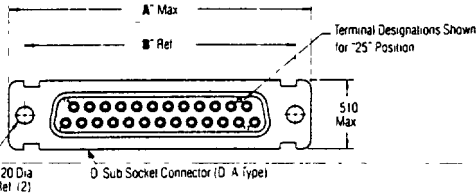
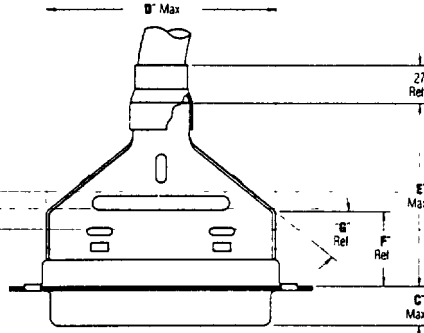

120 Dia Ref (2)  
D Sub Socket Connector (D'A Type)

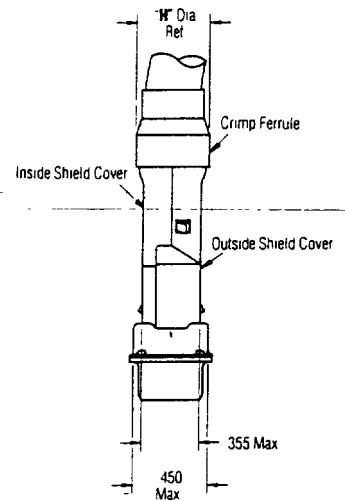

## Dimensions-Shielding Kits (Comprising connector & 2 piece screening can)

No. of Contacts	Part Number	A		B		C		D		E		F		G Deg.	H	
		in	mm	in	mm	in	mm	in	mm	in	mm	in	mm		in	mm
9 Plug	234-09-24-131	1.228	31.19	0.984	24.99	0.270	6.86	0.705	17.91	1.320	33.53	0.520	13.21	75°	0.440	11.18
9 Socket	233-09-22-131	1.228	31.19	0.984	24.99	0.285	7.24	0.705	17.91	1.320	33.53	0.520	13.21	75°	0.440	11.18
15 Plug	234-15-24-131	1.556	39.52	1.312	33.33	0.270	6.86	1.050	26.67	1.320	33.53	0.520	13.21	58°	0.440	11.18
15 Socket	233-15-22-131	1.556	39.52	1.312	33.33	0.285	7.24	1.050	26.67	1.320	33.53	0.520	13.21	58°	0.440	11.18
25 Plug	234-25-24-131	2.103	53.42	1.852	47.04	0.275	6.99	1.590	40.39	1.320	33.53	0.520	13.21	40°	0.440	11.18
25 Socket	233-25-22-131	2.103	53.42	1.852	47.04	0.285	7.24	1.590	40.39	1.320	33.53	0.520	13.21	40°	0.440	11.18
37 Plug	234-37-24-131	2.744	69.70	2.500	63.50	0.275	6.99	2.240	56.90	1.620	41.15	0.750	19.05	32°	0.520	13.21
37 Socket	233-37-22-131	2.744	69.70	2.500	63.50	0.285	7.24	2.240	56.90	1.620	41.15	0.750	19.05	32°	0.520	13.21

## Dimensions-Crimp Ferrule (Order separately)

Part Number	Type	J		K		L		Crimp Die Part No.
		in	mm	in	mm	in	mm	
462-44-22-451	1	.437	11.10	.200	5.08	.450	11.43	598-98-97-607
462-44-22-442	1	.437	11.10	.235	5.97	.450	11.43	598-98-97-600
462-44-22-443	1	.437	11.10	.250	6.35	.450	11.43	598-98-97-601
462-44-22-444	1	.437	11.10	.325	8.26	.450	11.43	598-98-97-602
462-44-22-445	1	.437	11.10	.350	8.89	.450	11.43	598-98-97-603
462-44-22-446	1	.437	11.10	.375	9.53	.450	11.43	598-98-97-604
462-44-22-447	2	.437	11.10	.437	11.10	.450	11.43	598-98-97-605
462-44-22-450	2	.460	11.68	.460	11.68	.450	11.43	598-98-97-606

## Crimp Ferrule

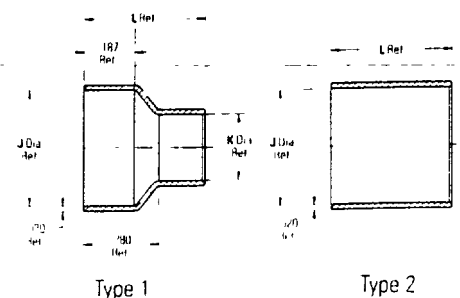

## Series 3

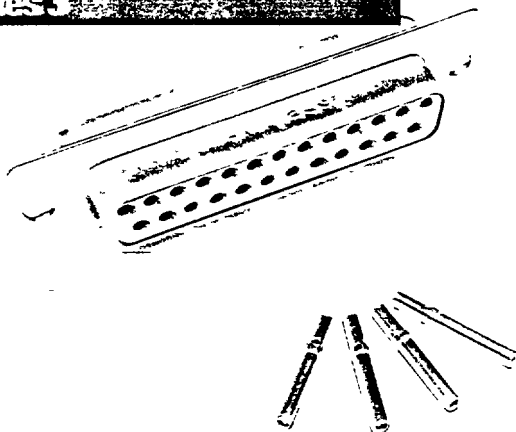

Dimensions (mm)

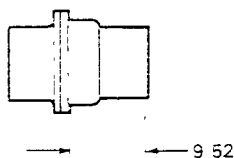

- Approved to MIL-C-24308
- Probe-proof socket contacts
- Intermateable with other D Subminiature connectors
- Complete flexibility of contact loading
- Superb contact retention by metal clip
- Ideal for high temperature applications
- UL 94V-0 rated G.F. Diallyl Phthalate insulators for maximum electrical performance
- Choice of shell plating
- Low residual magnetism versions available

### Machined contacts for higher reliability applications



Socket contacts have stainless steel sleeves to prevent damage by probes

## Technical Data

Termination Style	Crimp
Number of Contacts	9 15 25 37 50
Maximum Insertion & Extraction Force	30 50 83 123 167N
Performance Level	Military to MIL-C-24308
Wire Accommodation	20 - 24 AWG
Plug Contact Material	Copper Alloy
Socket Contact Material	Copper Alloy with Stainless Steel Sleeve

Current Rating	5A
Withstanding Voltage	1.25 Kv a.c. rms
Contact Resistance	$2.7m \times 10^{-3} \Omega$ max
Insulation Resistance	$\geq 5 \times 10^9 \Omega$
Temperature Range	-55°C to +125°C
Insulator Material	GF Diallyl Phthalate per MIL-M-14 UL 94V-0 rated
Shell Materials	Steel or brass with zinc, bright tin, gold or cadmium plating

## Part Numbering

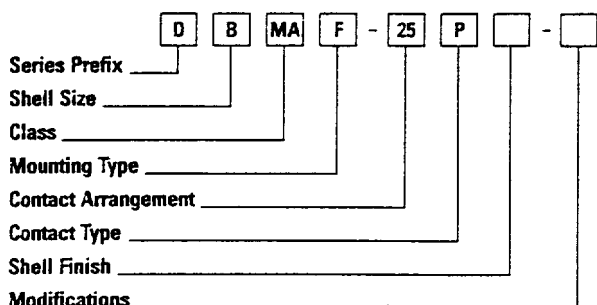

Series Prefix	D
Shell Size	E, A, B, C or D
Class	MA - Series 3 MAM - Commercial equivalent to M24308
Mounting Type	E - 4-40 clinch-nut for rear panel mounting with locking feature for high vibration applications F - Float mount for rear panel mounting R - Reverse float mount for front panel mounting Y - Universal float mount for front or rear panel mounting No designation - $\varnothing 3.05mm$ mounting hole
Contact Arrangement	9, 15, 25, 37 or 50
Contact Type	P or S
Shell Finish	T - Bright tin TI - Bright tin with grounding indents (plugs only) No designation - Zinc plated with yellow chromate passivation Class MAM - Cadmium plated with yellow chromate passivation
Modifications	FO - Supplied without contacts (The modification code is not marked on the connector) No designation - Supplied with turned contacts For other shell materials or finishes, please consult the Sales Office

## Part Numbering for Connectors to MIL-C-24308

### Plugs

Number of Contacts	With Contacts				Without Contacts			
	Steel Passivated Shell	Steel Passivated Shell (with Float Mounts)	Brass Non Magnetic Shell	Brass Non Magnetic Shell (with Float Mounts)	Steel Passivated Shell	Steel Passivated Shell (with Float Mounts)	Brass Non Magnetic Shell	Brass Non Magnetic Shell (with Float Mounts)
9	M24308/4-1	M24308/4-302	M24308/8-1	M24308/8-302	M24308/4-259	M24308/4-324	M24308/8-259	M24308/8-324
15	M24308/4-2	M24308/4-303	M24308/8-2	M24308/8-303	M24308/4-260	M24308/4-325	M24308/8-260	M24308/8-325
25	M24308/4-3	M24308/4-304	M24308/8-3	M24308/8-304	M24308/4-261	M24308/4-326	M24308/8-261	M24308/8-326
37	M24308/4-4	M24308/4-305	M24308/8-4	M24308/8-305	M24308/4-262	M24308/4-327	M24308/8-262	M24308/8-327
50	M24308/4-5	M24308/4-306	M24308/8-5	M24308/8-306	M24308/4-263	M24308/4-328	M24308/8-263	M24308/8-328

### Sockets

Number of Contacts	With Contacts				Without Contacts			
	Steel Passivated Shell	Steel Passivated Shell (with Float Mounts)	Brass Non Magnetic Shell	Brass Non Magnetic Shell (with Float Mounts)	Steel Passivated Shell	Steel Passivated Shell (with Float Mounts)	Brass Non Magnetic Shell	Brass Non Magnetic Shell (with Float Mounts)
9	M24308/2-1	M24308/2-23	M24308/6-1	M24308/6-259	M24308/2-281	M24308/2-292	M24308/6-281	M24308/6-324
15	M24308/2-2	M24308/2-24	M24308/6-2	M24308/6-260	M24308/2-282	M24308/2-293	M24308/6-282	M24308/6-325
25	M24308/2-3	M24308/2-25	M24308/6-3	M24308/6-261	M24308/2-283	M24308/2-294	M24308/6-283	M24308/6-326
37	M24308/2-4	M24308/2-26	M24308/6-4	M24308/6-262	M24308/2-284	M24308/2-295	M24308/6-284	M24308/6-327
50	M24308/2-5	M24308/2-27	M24308/6-5	M24308/6-263	M24308/2-285	M24308/2-296	M24308/6-285	M24308/6-328

### Contact Part Numbers

Description	To MIL-C-24308	Commercial	
		Performance Level 3	Performance Level 1
Plug	M39029/64-369	330-5291-000	330-5291-050
Socket	M39029/63-368	031-1007-000	031-1007-050

Note All the socket contacts above have an external stainless steel sleeve to prevent damage by probes

## Filter D

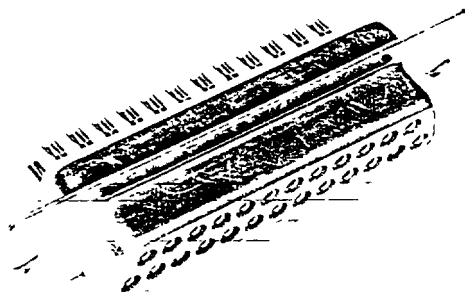

- Filters interference from signals
- Low loss at signal frequencies
- Helps make equipment compatible with FCC & FTZ regulations
- Fully potted construction for maximum resistance to hazardous environments
- The same size & footprint as standard Cinch D Connectors
- Standard European footprint - can be fitted straight onto existing PCBs
- Meets relevant dimensional requirements of BS9523 F0013, MIL-C-24308, DIN 41652 & BT217
- Bright tin finish & grounding indents for EMI/RFI shielding
- Nickel plated shells for EMI/RFI shielding.

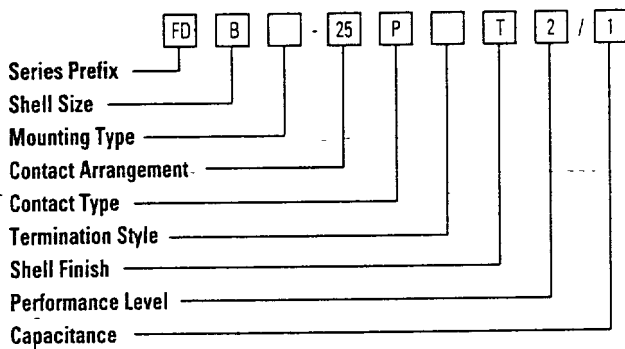

## Capacitive Filter

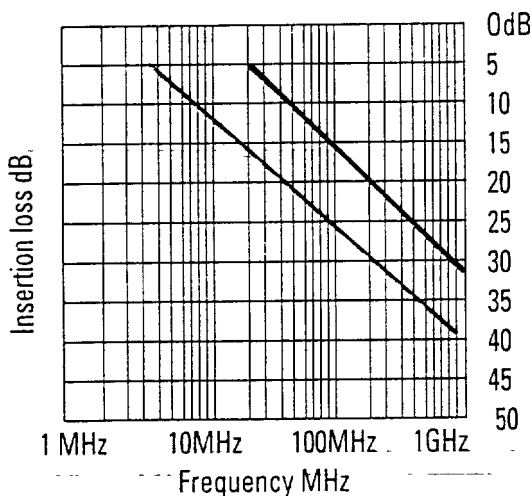

Typical performance relates to 50Ω system Mil - Std. - 220  
Capacitance - 330pF and 1 nF nominal at 1 KHz 0.1 rms

— 330 pF

— 1 nF

Termination Options	Solder Bucket, Flow Solder Straight & 90°				
Number of Contacts	9	15	25	37	50
Maximum Insertion & Extraction Force	30	50	83	123	167N
Performance Level	1, 2 & 3				
Wire Accommodation	≤ 0.5mm <sup>2</sup> (20AWG)				
Plug Contact Material	Copper Alloy				
Socket Contact Material	Copper Alloy				

Current Rating	5A
Capacitance	1nF and 330 pF Tol -80% -20%
Working Voltage	200V d.c. or a.c. peak
Contact Resistance	5 x 10 <sup>3</sup> Ω max
Insulation Resistance	≥ 5 x 10 <sup>3</sup> Ω
Insulator Materials	High impact Epoxy & GF Polyester UL 94V-0 Rated
Shell Materials	Front - Steel - Bright tin finish with grounding indents on plugs Rear - Steel - Electrolytic nickel



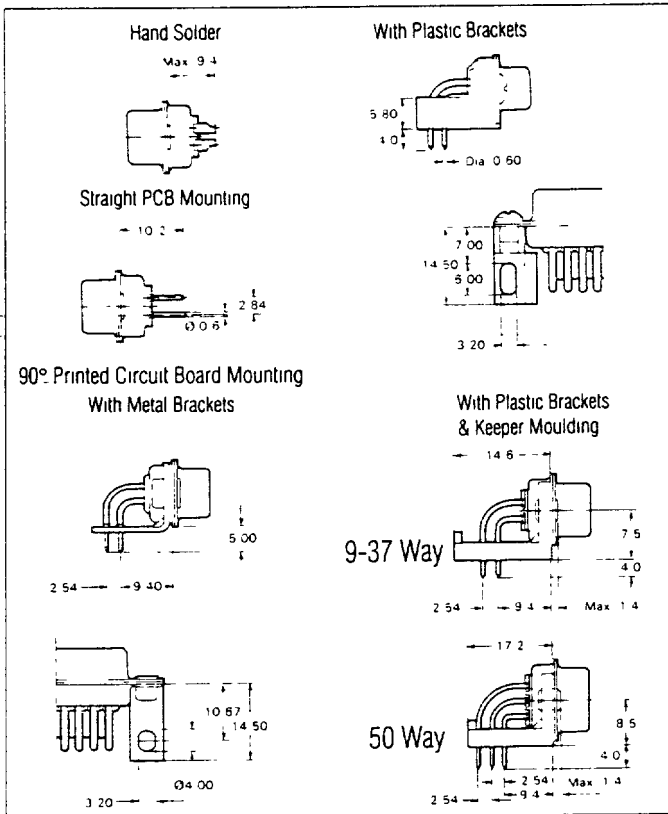

<b>Series Prefix</b>	<b>FD</b> -Filtered D ( <b>Standard Prefix</b> )
<b>Shell Size</b>	<b>E, A, B, C or D (All Standard)</b>
<b>Mounting Type</b>	<b>B</b> -4-40 riv-nut for rear panel mounting ( <b>Standard</b> )
	<b>P</b> -M3 riv-nut for rear panel mounting
	<b>D</b> - With female screw locks fitted
	<b>E</b> -4-40 clinch-nut for rear panel mounting with locking feature for high vibration applications
	<b>F</b> -Float mount for rear panel mounting
	<b>Y</b> -Universal float mount
	No designation - $\varnothing$ 3.05mm mounting hole ( <b>Standard</b> )
	90° Flow Solder versions are not available with float mounts
<b>Contact Arrangement</b>	<b>9, 15, 25, 37, or 50 (All Standard)</b>
<b>Contact Type</b>	<b>P or S (Both Standard)</b>
<b>Termination Style</b>	
90° Flow Solder	<b>1A0N</b> -Without brackets ( <b>Standard</b> )
European Footprint	<b>1A1N</b> -With plastic brackets
	<b>1A2N</b> -With plastic brackets and keeper moulding
	<b>1A3N</b> -With metal mounting brackets*
	<b>1AEN</b> -With earthing straps on plastic brackets ( <b>Standard</b> ) with keeper moulding*
	<b>1ASN</b> - With board locks, earthing straps, plastic ( <b>Standard</b> ) bracket and keeper-moulding*
	<b>For reverse orientation of contacts relative to shell, replace N with R</b>
	<b>*Please specify riv-nuts or screw locks.</b>
	<b>mounting types B, P, or D (riv-nuts Standard)</b>
	50 Way 90° PCB mounting available as 1A0N and 1A2N only
<b>Straight Flow Solder</b>	<b>OL2</b> -Termination $\varnothing$ 0.6mm, 5.3mm long ( <b>Standard</b> )
	<b>BL2</b> -Termination $\varnothing$ 0.6mm, 5.3mm long with board locks
<b>Mini Wire Wrap</b>	<b>F179A</b> - 0.61mm square section pins for up to 3 wraps
<b>Solder Bucket</b>	<b>No designation required (Standard)</b>
<b>Shell Finish</b>	<b>T</b> Nickel plated ( <b>Standard</b> )
	<b>TI</b> Nickel plated with grounding indents (plugs only) ( <b>Standard</b> )
<b>Performance Level</b>	<b>1</b> -As BT 217
	<b>2</b> -DIN Class 2 ( <b>Standard</b> )
	<b>3</b> -Exceeds DIN Class 3
<b>Capacitance</b>	<b>1</b> -1 nF ( <b>Standard</b> )
	<b>3</b> -330 pF

## Plating Specification

Performance Level	Performance	Comment
1	500 Matngs minimum followed by 21 day industrial atmosphere test and 21 day damp heat test to BS 2011	Meets BT 217 exceeds DIN Class 2
2	100 Matngs minimum followed by 21 day damp heat test and 4 day industrial atmosphere test	Meets DIN Class 2
3	250 Matngs minimum followed by 21 day damp heat test at 93% relative humidity to BS 2011, Part 2, 1 Ca. Net contact resistance will not then exceed 5 milliohms	Exceeds DIN Class 3

## Metal Shell IDC

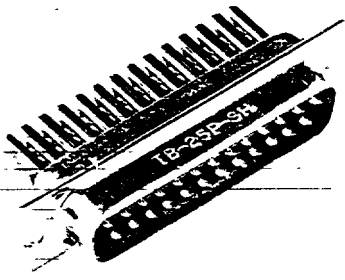

- High speed termination
- Insulator materials are UL 94V-0 rated
- Standard RS 232 interface
- Bright tin finish and grounding indents available for EMI/RFI screening
- Compatible with all other D Subminiatures
- Four point IDC termination with strain relief
- Complete system with hoods

## Technical Data

Termination Options	Individual Conductor Insulation Displacement			
Number of Contacts	9	15	25	37
Maximum Insertion & Extraction Force	30	50	83	123N
Performance Level	3			
Wire Accommodation	24-26 AWG solid/stranded wire			
Plug Contact Material	Copper Alloy			
Socket Contact Material	Copper Alloy			

Current Rating	3A
Withstanding Voltage	1,000 V a c rms
Contact Resistance	$5 \times 10^{-3} \Omega$ max
Insulation Resistance	$\geq 5 \times 10^9 \Omega$
Temperature Range	-55°C to + 125°C
Insulator Material	GF Polyester UL 94V-0 Rated
Shell Materials	Steel with bright tin finish and grounding indents on plugs

## Part Numbering

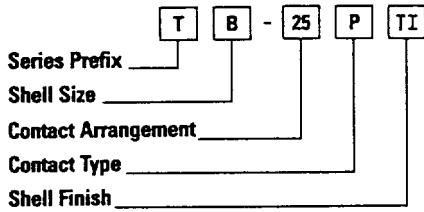

<b>Series Prefix</b>	<b>T</b>
<b>Shell Size</b>	<b>E, A, B or C</b>
<b>Contact Arrangement</b>	<b>9, 15, 25 or 37</b>
<b>Contact Type</b>	<b>P or S</b>
<b>Shell Finish</b>	<b>T</b> - Bright tin <b>TI</b> - Bright tin with grounding indents (plugs only) <b>SH</b> - Zinc plated with yellow chromate passivation
<b>No designation</b>	- Zinc plated shell

For Flat Cable IDC, please see page 31

## Metal Shell IDC

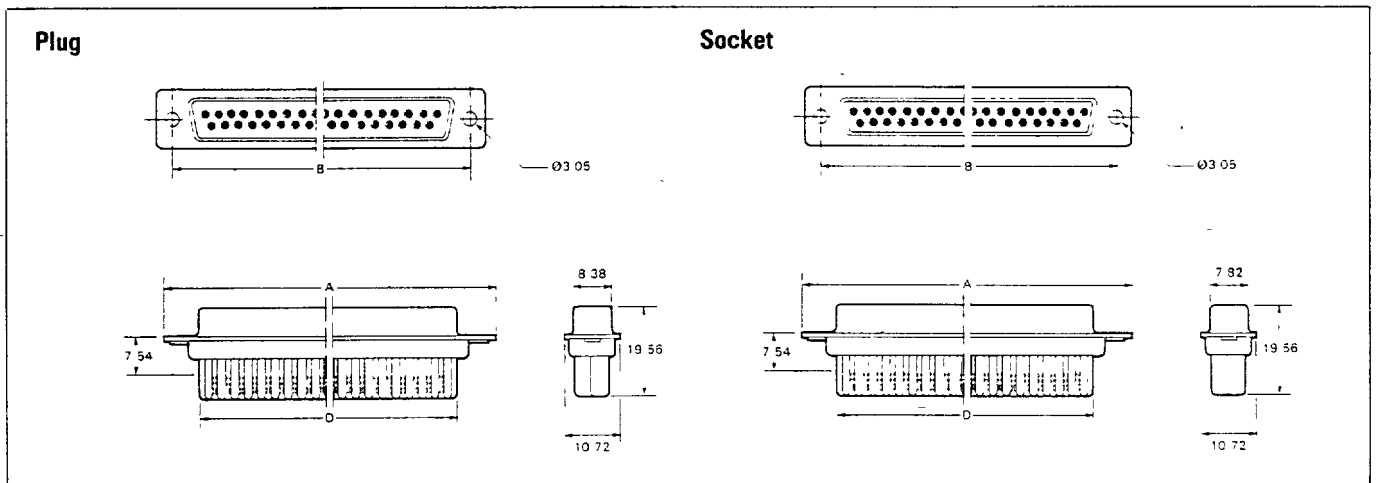

## Connector Dimensions

Number of Contacts	Dimensions (mm)				
	A	B	C	D	E
9	22.86	24.99	33.25	15.04	30.71
15	30.53	33.32	41.55	23.31	39.01
25	44.27	47.04	55.35	37.13	52.81
37	60.73	63.50	71.73	53.70	69.19

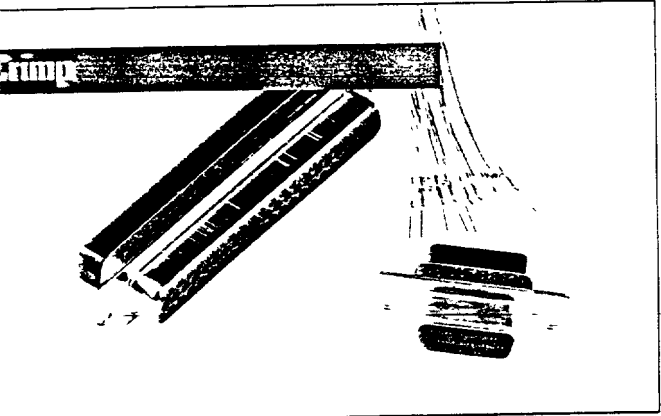

- Higher contact density to save space
- Specially designed for high volume commercial applications where cost is critical
- Accepts standard Cinch D Subminiature accessories
- UL 94V-0 rated insulators
- EMI/RFI grounded versions available
- Full termination tooling available Please (see page 47)
- Solder contacts available for service and other low volume applications
- 90° flow solder versions have integral earthing straps and board locks

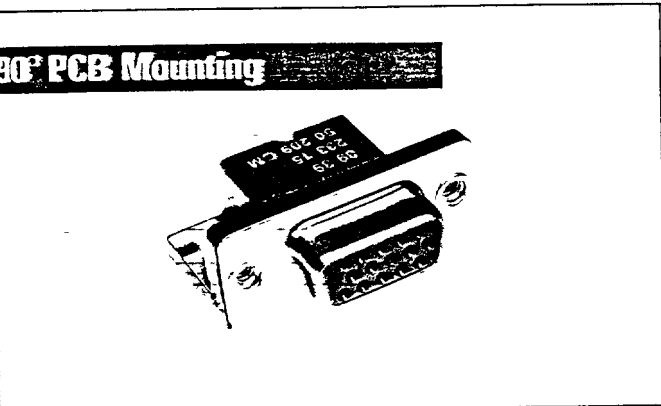

**Contact Arrangements**

(PIN mating face – use reverse order for socket)

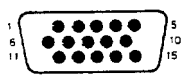

**E**  
15

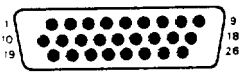

**A**  
26

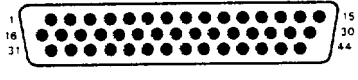

**B**  
44

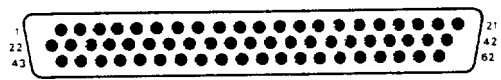

**C**  
62

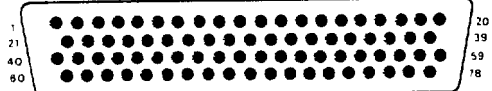

**D**  
78

**SHELL SIZE**  
No of contacts

**SHELL SIZE**  
No of contacts

**Technical Data**

<b>Termination Options</b>	Crimp & Hand 90° Flow Solder				
<b>Number of Contacts</b>	15	26	44	62	78
<b>Maximum Insertion &amp; Extraction Force</b>	45	76	125	174	218N
<b>Performance Levels</b>	1, 2 or 3				
<b>Wire Accommodation</b>	22-32 AWG				
<b>Plug Contact Material</b>	Copper Alloy				
<b>Socket Contact Material</b>	Copper Alloy				

<b>Current Rating</b>	5A
<b>Proof Voltage</b>	1 05 Kv d.c. or a.c. peak
<b>Working Voltage</b>	350V d.c. or a.c. peak
<b>Contact Resistance</b>	12 x 10 <sup>-1</sup> Ω max
<b>Insulation Resistance</b>	≥ 1 x 10 <sup>8</sup> Ω
<b>Temperature Range</b>	-55°C to +125°C
<b>Insulator Material</b>	GF Nylon UL 94V-0 rated
<b>Shell Materials</b>	Steel – zinc plated or bright tin finish with grounding indents on plugs

## Connector Dimensions

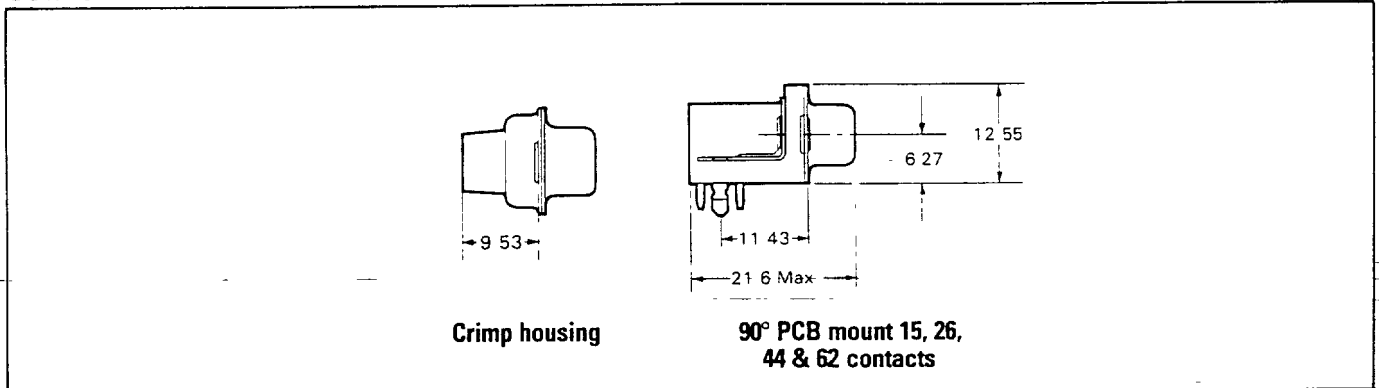

## PCB Mounting Details (component side shown)

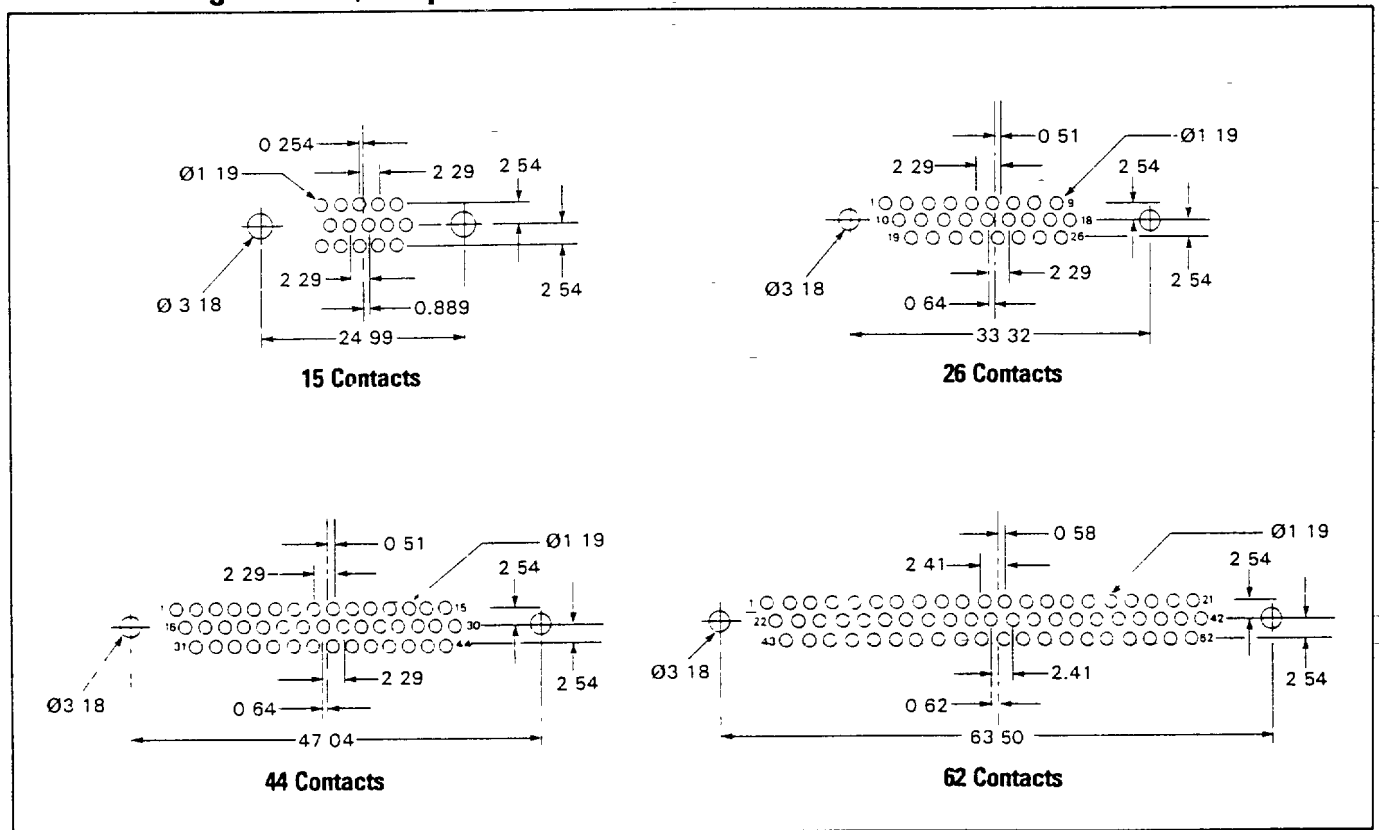

## Part Numbering

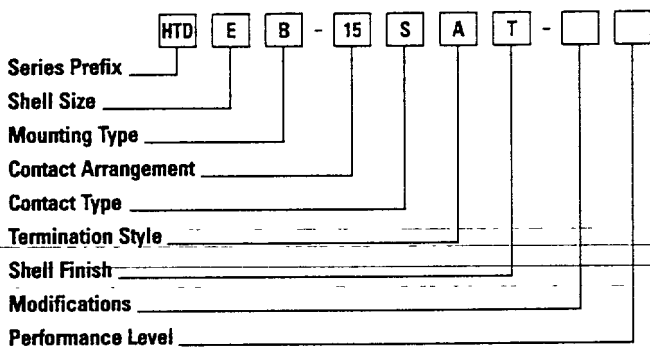

<b>Series Prefix</b>	<b>HTD</b>
<b>Shell Size</b>	<b>E, A, B, C or D</b>
<b>Mounting Type</b>	<b>B</b> - 4-40 riv-nut for rear panel mounting
	<b>No designation</b> - Ø 3.05mm mounting hole (90° PCB mount always supplied with riv-nuts)
<b>Contact Arrangement</b>	<b>15, 26, 44, 62 or 78</b>
<b>Contact Type</b>	<b>P or S</b>
<b>Termination Style</b>	<b>A</b> - 90° PCB mount
	<b>OL2</b> - Straight flow solder
	<b>No designation</b> - Crimp housing supplied without contacts (also accepts solder contacts)
<b>Shell Finish</b>	<b>T</b> - Bright tin
	<b>TI</b> - Bright tin with grounding indents (plugs only)
	<b>No designation</b> - Zinc plating with yellow chromate passivation
<b>Modifications</b>	<b>FO</b> - Crimp or solder version signifies contacts are supplied separately (not marked on connector)
<b>Performance Level</b>	<b>2</b> - DIN Class 2
	<b>1</b> - As BT217
	<b>No designation</b> - Performance level 3

## Crimp Contact Part Numbers

Version	Performance Level	Pin Contacts	Socket Contacts
15,000 Reels 22-28 AWG	3	HTDCP9-15000	HTDCS9-15000
300 Reels 22-28 AWG	3	HTDCP9-300	HTDCS9-300

## Solder Contact Part Numbers

Version	Performance Level	Pin Contacts	Socket Contacts
Strips of 10 contacts	3	HTDSP9-10L	HTDSS9-10L

Solder contacts are supplied in strips of 10 for hand soldering and insertion into crimp style housings

For additional plating variations and wire accommodations, please consult the factory

## Double Density

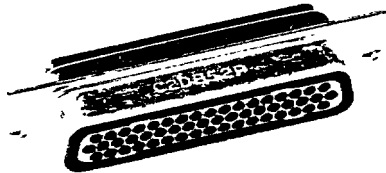

- Very high contact density – up to 100 Ways
- High reliability twist pin contacts
- Conventional D Subminiature accessories can be used
- Superb shock and vibration resistance
- Retains electrical continuity under most arduous conditions
- Crimp contacts
- Part loading possible
- Contacts are removable/replaceable
- Not interchangeable with standard D Subminiatures
- UL 94V-0 rated insulators

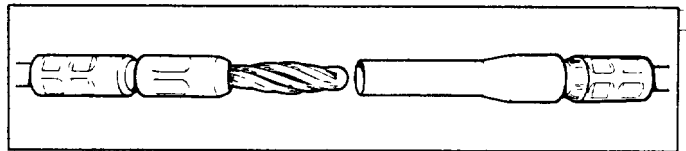

### Contact Arrangements

(Pin Mating Face – use reverse order for socket)

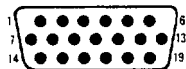

SHELL SIZE **E**  
No of contacts **19**

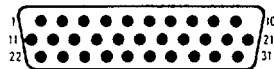

SHELL SIZE **A**  
No of contacts **31**

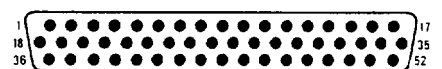

SHELL SIZE **B**  
No of contacts **52**

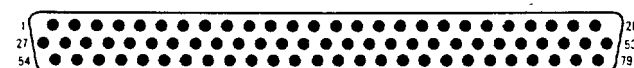

SHELL SIZE **C**  
No of contacts **79**

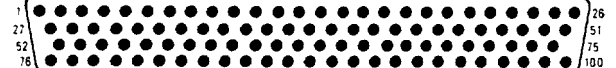

SHELL SIZE **D**  
No of contacts **100**

Contact I.D. numbers are for reference only and not marked on connector.

## Technical Data

<b>Termination Style</b>	Crimp	<b>Current Rating</b>	5A
<b>Number of Contacts</b>	19 31 52 79 100	<b>Withstanding Voltage</b>	900 V a.c. rms
<b>Maximum Insertion &amp; Extraction Forces</b>	40 71 119 180 228N	<b>Contact Resistance</b>	9 x 10 <sup>-3</sup> Ω max
<b>Wire Accommodation</b>	22-26 AWG	<b>Insulation Resistance</b>	≥ 5 x 10 <sup>8</sup> Ω
<b>Plug Contact Material</b>	Copper Alloy	<b>Operating Temperature</b>	-55°C to +125°C
<b>Socket Contact Material</b>	Copper Alloy	<b>Insulator Material</b>	GF Polyester UL94V-0 Rated
		<b>Shell Materials</b>	Steel – cadmium plated with yellow chromate passivation

## Part Numbering

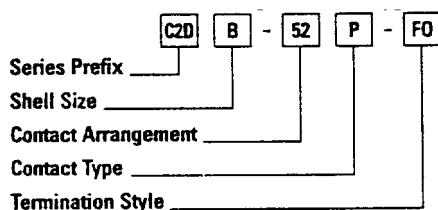

Series Prefix **C2D**  
Shell Size **E, A, B, C or D**  
Contact Arrangement **19, 31, 52, 79 or 100**  
Contact Type **P or S**  
Termination Style **FO**

– Crimp supplied without contacts (The termination code is not marked on the connector)

Description	Part Number
Twist Pin Contact	C2-22-M
Socket Contact	C2-22-F

## Superfast IDC D

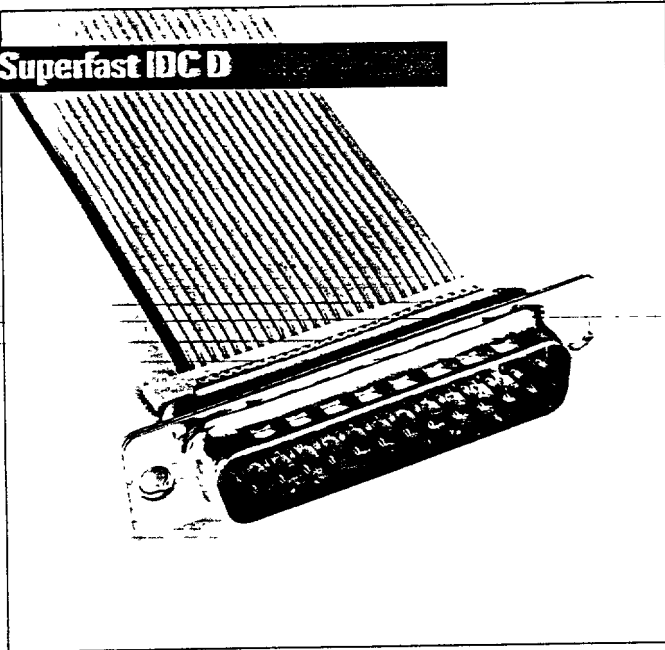

- High speed mass termination
- Low profile
- Steel shell for maximum strength
- Strain relief included
- Standard RS 232 interface
- UL 94V-0 rated insulators & strain relief
- Bright tin finish & grounding indents for EMI/RFI shielding
- Compatible with all other D Subminiatures
- Backshell & jack screws available (see page 44)

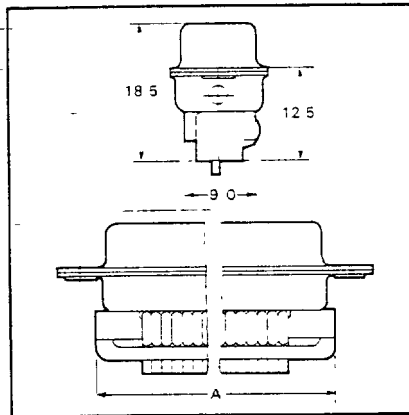

Number of Contacts	A
9	20.2
15	28.6
25	42.3
37	58.8

## Technical Data

Termination Style	Insulation Displacement
Number of Contacts	9 15 25 37
Maximum Insertion & Extraction Forces	30 50 83 123N
Performance Levels	2 or 3
Wire Accommodation	26-28 AWG
Plug Contact Material	Phosphor Bronze
Socket Contact Material	Phosphor Bronze





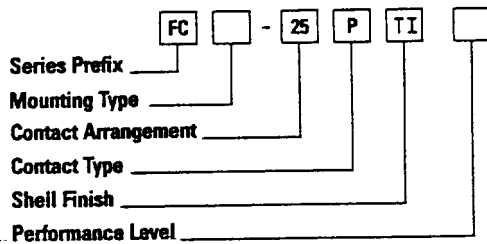





Current Rating	1A
Proof Voltage	1.05 Kv d.c. or a.c. peak
Working Voltage	350V d.c. or a.c. peak
Contact Resistance	$15 \times 10^{-3} \Omega$ max
Insulation Resistance	$\geq 1 \times 10^9 \Omega$
Temperature Range	-55°C to +85°C Limited by PVC insulation on ribbon cable
Insulator Material	GF Polyester UL 94V-0 rated
Shell Materials	Steel - zinc plated or bright tin finish with grounding indents on plugs







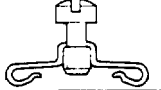

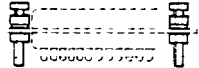

## Part Numbering



Series Prefix	FC
Shell Size	E A B C
Mounting Type	B - 4-40 nv-nut for rear panel mounting F - Float mount bushes P - M3 nv-nut for rear panel mounting No designation - Ø 3.05mm mounting hole
Contact Arrangement	9, 15, 25 or 37
Contact Type	P or S
Shell Finish	T - Bright tin TI - Bright tin with grounding indents (plugs only) No designation - Zinc plating with yellow chromate passivation
Performance Level	2 - DIN Class 2 1 - DIN Class 1 No designation - Performance level 3

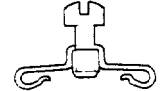

								
For further details please See Page No.	35	35	36	36	37	39	40	40
Sizes available	E A B C	E A B C D	A B	B	E A B C	E A B C D	E A B C D	E B
Straight Cable Outlet	●	●	●	●	●	●		●
90° Cable Outlet	●	●			●			
45° Cable Outlet							●	
Incorporates Cable Clamping	●	●	●	●	●	●	●	●
Incorporates Locking System	●		●	●	●	●	●	●
For Use With	Low Cost D	●	●	●	●	●	●	●
	Standard D	●	●	●	●	●	●	●
	Econo DA & Econo C	●	●	●	●	●	●	●
	Metal Shell IDC	●	●	●	●	●	●	●
	Superfast IDC D							
	Series 1	●	●	●	●	●	●	●
	Series 3	●	●	●	●	●	●	●
	Spacesaver HTD22	●	●	●	●	●	●	●
	Double Density	●	●	●	●	●	●	●
			●	●	●	●		●
								
	●	●					●	
	●	●					●	

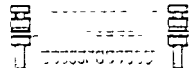
							
For further details please See Page No.	41	42	42	43	43	44	44
Sizes available	EABCD	EABCD	AB	ABCD	EABCD	ABCD	EABC
Straight Cable Outlet	●	●	●	●			●
90° Cable Outlet	●				●		
45° Cable Outlet							
Incorporates Cable Clamping	●	●	●	●	●		●
Incorporates Locking System							●
For Use With	Low Cost D	●	●	●	●	●	
	Standard D	●	●	●	●	●	
	Econo DA & Econo C	●	●	●	●	●	
	Metal Shell IDC	●	●	●	●	●	
	Superfast IDC D	●					●
	Series 1	●	●	●	●	●	
	Series 3	●	●	●	●	●	
	Spacesaver HTD22	●	●	●	●	●	
	Double Density	●	●	●	●	●	
	●	●	●	●		●	●
	●	●	●	●		●	
	●	●	●	●	●	●	
	●	●	●	●	●	●	

N.B  
Accessories  
shown are not  
necessarily  
supplied with  
connectors

## Universal Back Shells

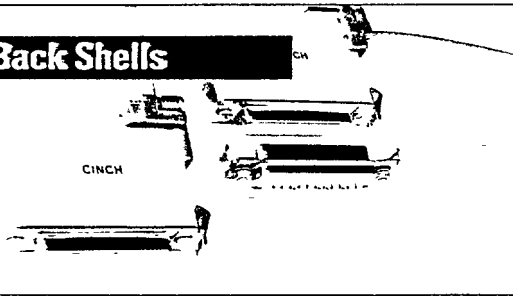

- Universal fitting straight & 90° outlet
- Extra strong cable clamp
- Suitable for use with slide locks
- Supplied complete with clips and retainers
- UL 94V-0 rated moulded parts

## Clips and Retainers

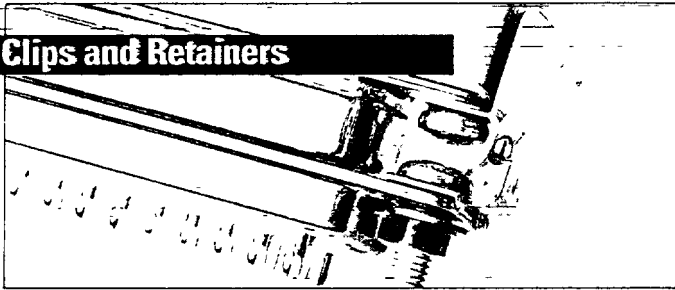

### 90° Outlet

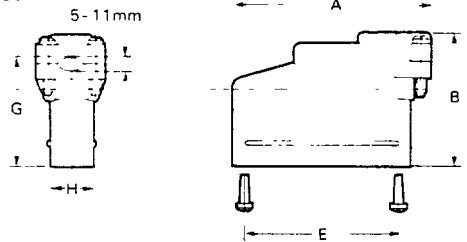

### Straight Outlet

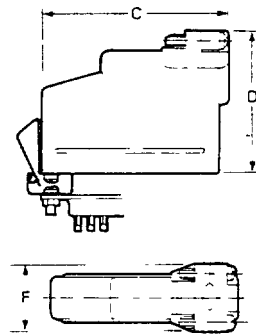

Shell Size	Part Number	Dimensions (mm)							
		A	B	C	D	E	F	G min	H
E	R43 00097 00 0A0 000	37.2	33.5	34.1	36.6	25.0	20.0	27.3	12.7
A	R43 00098 00 0A0 000	45.6	33.5	42.5	36.6	33.3	20.0	27.3	12.7
B	R43 00099 00 0A0 000	59.2	39.5	56.1	42.6	47.05	20.0	33.3	12.7
C	R43 00100 00 0A0 000	75.6	39.5	72.5	42.6	63.50	20.0	33.3	12.7

## All Plastic Straight and Right Angle

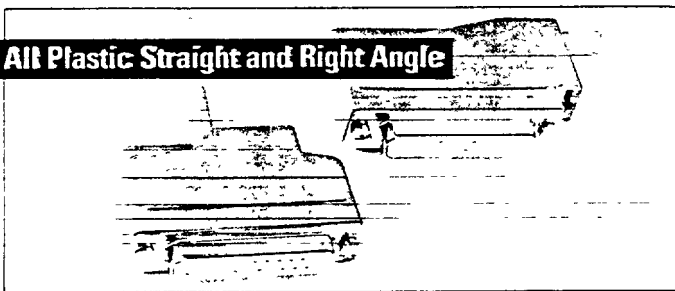

- Straight or 90° outlet
- Minimum width for applications where packing density is important
- Suitable for use with slide locks

### 90° Outlet

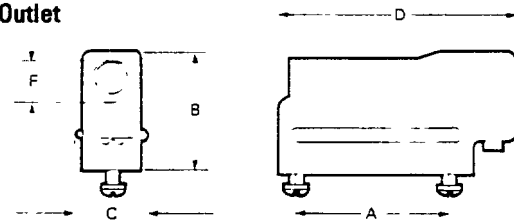

### Straight Outlet

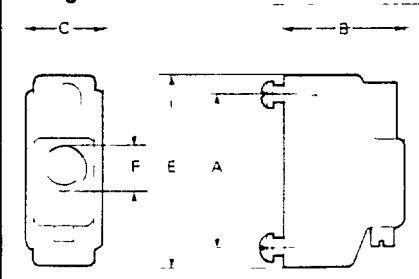

Shell Size	Outlet Orientation	Part Number	Dimensions (mm)					
			A	B	C	D	E	F
E	90°	DE51219-1	25.0	25.4	14.3	38.1		7.1
	Straight	DE51218-1	25.0	25.4	14.3		30.9	7.1
A	90°	DA51211-1	33.3	25.4	14.3	46.3		9.1
	Straight	DA51210-1	33.3	25.4	14.3		39.3	9.1
B	90°	DB51213-1	47.05	31.7	14.3	60.1		12.5
	Straight	DB51212-1	47.05	31.7	14.3		53.2	12.5
C	90°	DC51215-1	63.5	38.1	14.3	76.4		17.6
	Straight	DC51214-1	63.5	38.1	14.3		69.4	17.6
D	90°	DD51217-1	61.1	38.1	17.0	74.0		18.6
	Straight	DD51216-1	61.1	38.1	17.0		67.1	18.6

## Dataphone Hood

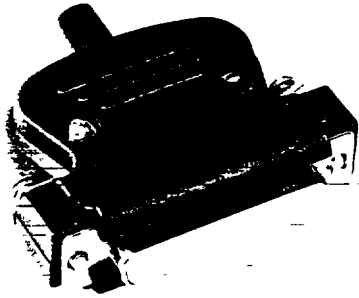

- Low cost
- Supplied complete with jack screws

### Dataphone Hood

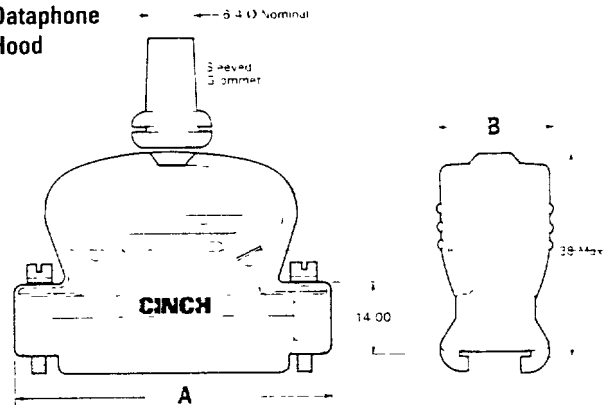

Shell Size	Part Number	Dimensions (mm)	
		A	B
A	DA 51225-1	32.94	19.84
B	DB 51226-1	57.00	22.00

## Slimline Hood

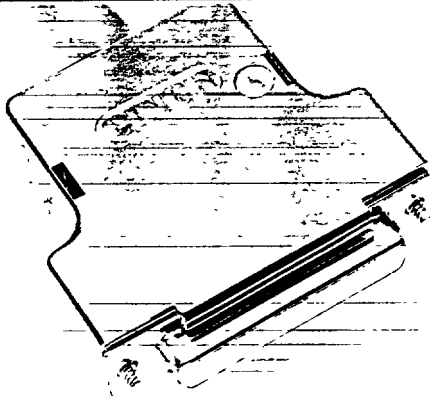

- Slim to accommodate high packing density
- Robust cable clamp
- Metalised for E.M.I./R.F.I. shielding
- Supplied complete with jack screws or finger screws

### Slimline Hood

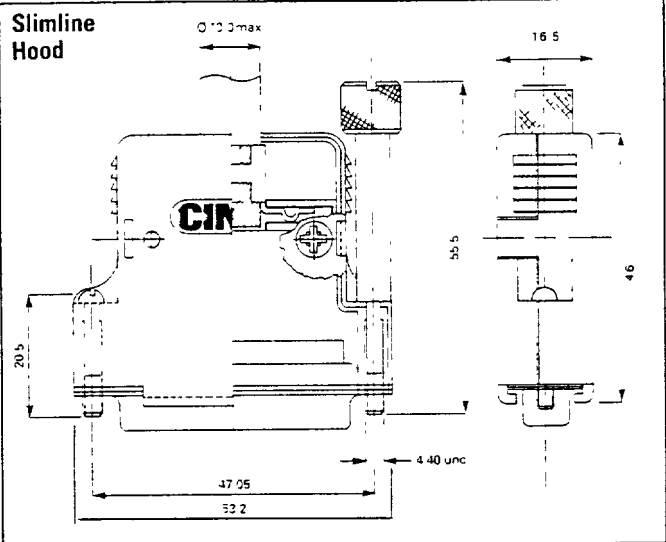

Shell Size	Part Number		
	with long jack screws	with short jack screws	without jack screws
B	R10 00016 00 00A 000	R10 00016 00B 000 000	R10 00016 00 000 000

### Straight Super D Hood

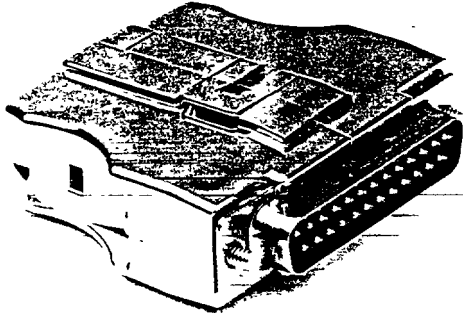

- Available with jack screws
- Metallised versions available for EMI/RFI screening (see page 39)
- Snap-together design for high speed assembly
- Stay band gives maximum strain relief
- Choice of cable openings
- Straight and right angle styles available
- UL 94V-0 rated moulded parts

### Metal Shell IDC with Strain Relief

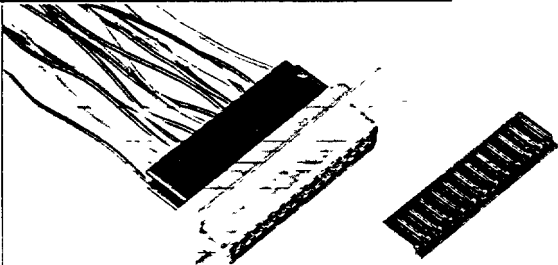

Shell Size	Dimensions (mm)				
	A	B	C	D	E
E	37.34	7.87	—	49.21	31.75
A	45.72	7.87	10.41	57.15	34.13
B	59.69	8.40	11.94	74.61	38.10
C	75.95	9.40	12.70	91.28	38.89

### Hood for use with Screw Locks.

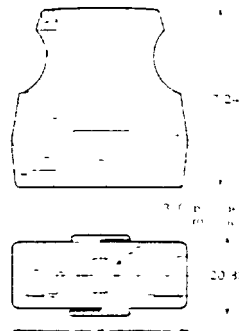

### Materials

Standard Hood Material Modified Phenylene Oxide  
 Latching Block Material Zinc die cast  
 Screw Material Steel  
 Screw Plating Nickel

## Hoods for use with Metal Shell Connectors

### Straight Hoods – Standard Cable Opening

Shell Size	With Latches	With Plain Mounting Holes	With Two Captivated 4-40 Screws
E	SDH-9BL	SDH-9BF	SDH-9BFCS
A	SDH-15BL	SDH-15BF	SDH-15BFCS
B	SDH-25BL	SDH-25BF	SDH-25BFCS
C	SDH-37BL	SDH-37BF	SDH-37BFCS

### Stay Bands & Wire Covers (Strain Reliefs)

Shell Size	Stay Bands	Wire Covers/Strain Reliefs
		For Metal Shell IDC Connectors
E	SD-9-15-SB	SSD-WC9
A	SD-9-15-SB	SSD-WC15
B	SD-25-37-SB	SSD-WC25
C	SD-25-37-SB	SSD-WC37

### Straight Hoods – Large Cable Opening

Shell Size	With Latches	With Plain Mounting Holes	With Two Captivated 4-40 Screws
A	SDH-15BLL	SDH-15BFL	SDH-15BLCS
B	SDH-25BLL	SDH-25BFL	SDH-25BLCS
C	SDH-37BLL	SDH-37BFL	SDH-37BLCS

### Right Angle Hoods

Shell Size	Standard Cable Opening	Large Cable Opening
E	SDH-9RBL	-
A	SDH-15RBL	SDH-15RBLL
B	SDH-25RBL	SDH-25RBLL
C	SDH-37RBL	SDH-37RBLL

### Screws

Screws for Screw Locking Connector Assembly. Two required per Hood.  
Part No 4-40-UNC2AX3/4

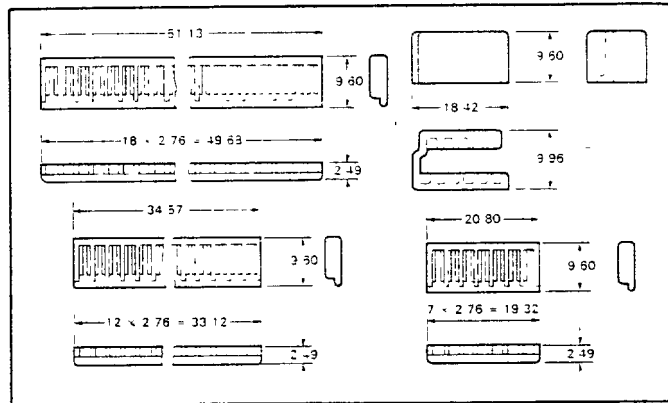

Wire covers fit both plugs and sockets. For the 9 contact size, the cover is in one piece – for all others 2 pieces are required.

## Snap-together Hoods

- Snap together for high speed assembly
- Metallised versions available for applications where screening is important – meets the applicable requirements of FCC Part 15 for Class A devices.
- Two styles of locking screws available
- Incorporates stay band for maximum strain relief

Shell Size	Metallised Hood	Unmetallised Hood	Stay Bands			Jack Screws	
			Ø 4.5-6.5 mm Cable	Ø 7.0-10.0 mm Cable	Ø 10.5-13.0 mm Cable	L <sub>1</sub> = 20.5 mm	L <sub>2</sub> = 55.5 mm
E	R10 60248 09 225 000	R10 60248 09 214 000	R10 60248 02 393 000	-	-	R10 60248 00 206 000	R10 60248 02 406 000
A	R10 60248 15 227 000	R10 60248 15 216 000	R10 60248 02 393 000	R10 60248 00 364 000	-	R10 60248 00 206 000	R10 60248 02 406 000
B	R10 60248 25 221 000	R10 60248 25 210 000	R10 60248 00 353 000	R10 60248 00 364 000	-	R10 60248 00 206 000	R10 60248 02 406 000
C	R10 60248 37 221 000	R10 60248 37 210 000	R10 60248 00 353 000	R10 60248 00 364 000	R10 60248 02 462 000	R10 60248 00 206 000	R10 60248 02 406 000
D	R10 60248 50 228 000	R10 60248 50 217 000	R10 60248 00 353 000	R10 60248 00 364 000	R10 60248 02 462 000	R10 60248 00 206 000	R10 60248 02 406 000

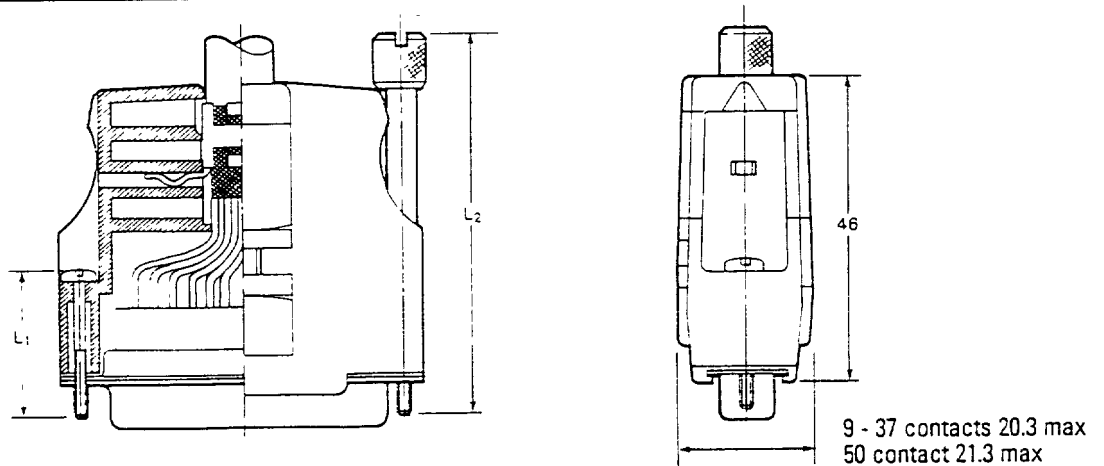

### Part Numbering for Kits with Stay Band and Short Jack Screws

Shell Size	Part Number	Metallised	Grey Unmetallised	Ø 4.5 - 6.5 mm Cable	Ø 7.0 - 10.0 mm Cable	Ø 10.5 - 13.0 mm Cable	Jack Screws 4-40 UNC	
							L <sub>1</sub> = 20.5 mm	L <sub>2</sub> = 55.5 mm
E	R10 60248 09 907 000	●	●	●			●	Please Order Separately
	R10 60248 09 913 000	●	●	●			●	
A	R10 60248 15 909 000	●	●	●	●		●	
	R10 60248 15 910 000	●	●	●	●		●	
B	R10 60248 25 903 000	●	●	●	●		●	
	R10 60248 25 914 000	●	●	●	●		●	
C	R10 60248 37 903 000	●	●	●	●	●	●	
	R10 60248 37 914 000	●	●	●	●	●	●	
D	R10 60248 50 900 000	●	●	●	●	●	●	
	R10 60248 50 911 000	●	●	●	●	●	●	

### Cinch Hoods & Die Cast Base Retainers

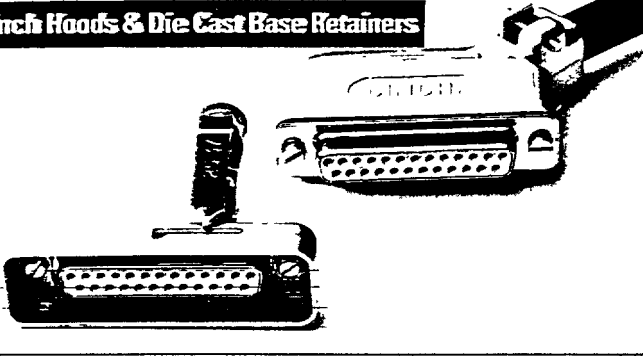

- BT 217 approved
- Solid die cast construction
- Positive termination of screen using pre-tapped hole
- Cover may be used with slide locks or base retainer

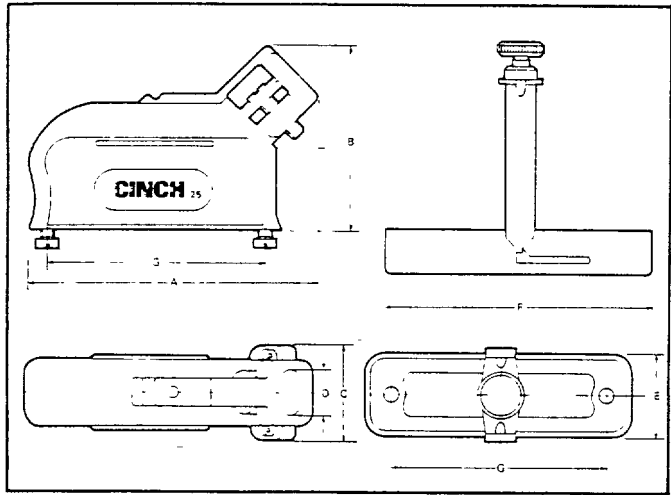

Shell Size	Dimensions (mm)						
	A	B	C	D max	E	F	G
E	40.4	33.5	20.6	9.52	18.0	35.7	24.99
A	48.4	33.5	20.6	9.52	18.0	44.4	33.32
B	60.0	39.5	20.6	9.52	18.0	58.0	47.04
C	76.4	39.5	20.6	9.52	18.0	74.6	63.50
D	74.9	39.9	23.4	12.70	20.8	72.0	61.11

Shell Size	Standard Hoods with 6BA Screws	Hoods with Mounting Holes Tapped 4-40 UNC for use with Slide Locks	Base Retainer Part Number	BT Code for Hood complete with Connector		BT Code for Base Retainer complete with Connector	
				Plug	Socket	Plug	Socket
E	R43 81960 00 000 000	R43 81960 00 00A 000	R43 00020 00 000 000	217A 09A	217C 09A	217B 09B	217D 09B
A	R43 81962 00 000 000	R43 81962 00 00A 000	R43 00021 00 000 000	217A 15A	217C 15A	217B 15B	217D 15B
B	R43 81964 00 000 000	R43 81964 00 00A 000	R43 00022 00 000 000	217A 25A	217C 25A	217B 25B	217D 25B
C	R43 81966 00 000 000	R43 81966 00 00A 000	R43 00023 00 000 000	217A 37A	217C 37A	217B 37B	217D 37B
D	R43 81968 00 000 000	R43 81968 00 00A 000	R43 00024 00 000 000	217A 50A	217C 50A	217B 50B	217D 50B

### Die Cast Split Hood

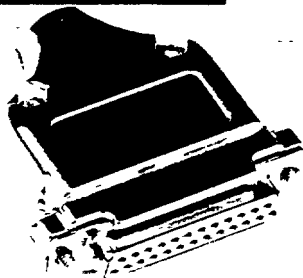

- Excellent EMI/RFI screening
- Supplied complete with jack screws
- Split for fitting after connectors are terminated

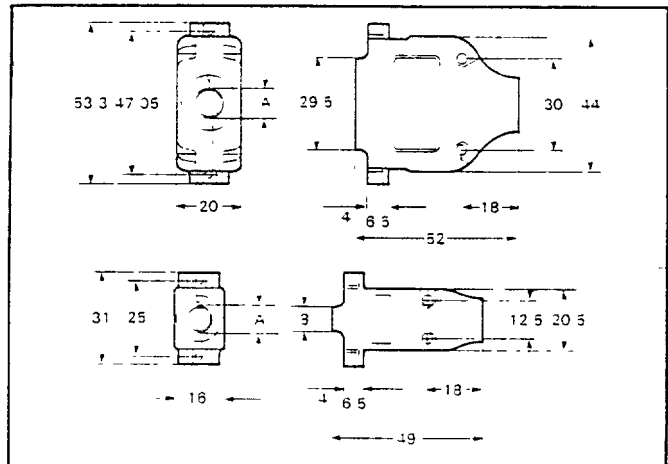

Shell Size	Part Number	Cable Diameter A (mm)
E	R10 60248 09 372 000	8.5
B	R10 00009 00 000 000	7.0
B	R10 60248 25 732 000	8.0
B	R10 60248 25 594 000	9.5



## Two-piece Backshells

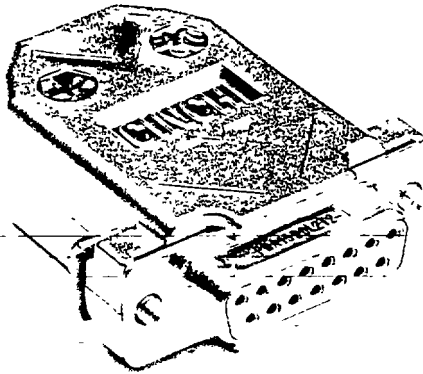

- Available in plastic, metallized plastic or diecast zinc
- Diecast or metallized plastic hoods provide EMI/RFI shielding
- Easy to assemble two-piece construction
- Reduces inventory through a range of compression inserts for different cable diameters packaged with each hood
- Fits both standard and 1.5 density D-Subminiature connectors
- Ethernet hoods available in standard 15-size configuration
- Packaged individually or bulk packed

## Ordering Information

Shell Size	Contacts Std. Density	Contacts 1.5 Density	Type	Part No.	Catalogue Part No.	A	B	C	D	E	F	Packaging
E	9	15	Metallized	239-13-99-308	DCH-E-001	1 225	1 397	640	640	400	984	Individual
			Plastic	239-13-99-313	DCH-E-002							Bulk
			Plastic	239-13-99-300	DPH-E-001							Individual
			Plastic	239-13-99-304	DPH-E-002							Bulk
A	15	26	Metallized	239-13-99-309	DCH-A-001	1 540	1 526	640	640	400	1 312	Individual
			Plastic	239-13-99-314	DCH-A-002							Bulk
			Plastic	239-13-99-301	DPH-A-001							Individual
			Plastic	239-13-99-305	DPH-A-002							Bulk
B	25	44	Metallized	239-13-99-310	DCH-B-001	2 090	1 655	710	640	522	1 857	Individual
			Plastic	239-13-99-315	DCH-B-002							Bulk
			Plastic	239-13-99-302	DPH-B-001							Individual
			Plastic	239-13-99-306	DPH-B-002							Bulk
C	37	62	Metallized	239-13-99-311	DCH-C-001	2 730	1 830	906	640	725	2 500	Individual
			Plastic	239-13-99-316	DCH-C-002							Bulk
			Plastic	239-13-99-303	DPH-C-001							Individual
			Plastic	239-13-99-307	DPH-C-002							Bulk
D	50	78	Metallized	239-13-99-312	DCH-D-001	2 645	1 855	940	750	725	2 406	Individual
			Plastic	239-13-99-317	DCH-D-002							Bulk
			Plastic	239-13-99-334	DPH-D-001							Individual
			Plastic	239-13-99-335	DPH-D-002							Bulk

Tools Required: Slot screwdriver, cutters

- Slide tightest fitting compression insert over cable.
- Fold braid or foil back over insert and trim excess with cutters.
- Install connector and close cover using slot screwdriver.

### Deep Straight Clamp

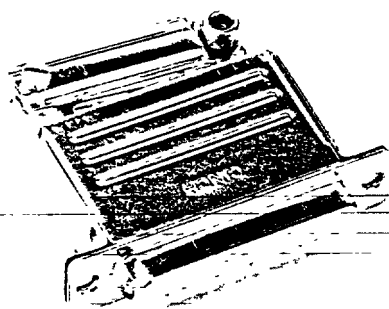

- Suitable for use with screw locks and slide locks
- Large cable opening
- Robust cable clamp
- Finished in yellow chromate to match the connectors

Shell Size	Part Number	Dimensions (mm)							
		A	B	C	D	E	F	G	H
E	DE-24657	30.6	24.99	12.3	9.5	9.5	31.0	19.1	14.7
A	DA-24658	38.9	33.32	12.3	7.9	18.1	31.8	19.1	14.7
B	DB-24659	52.8	47.04	12.3	7.9	25.4	38.9	25.4	14.7
C	DC-24660	69.0	63.50	12.3	7.9	34.9	38.9	25.4	14.7
D	DD-24661	66.7	61.11	15.1	10.3	35.7	42.1	28.6	17.5

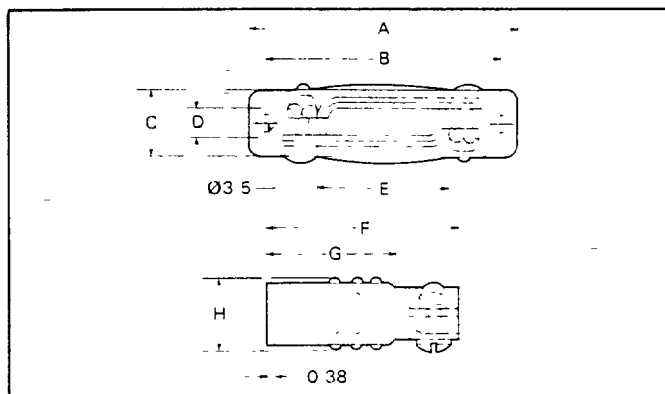

### Round Clamp

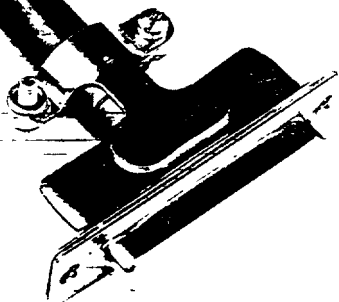

- Robust shell accepts round cables
- May be used with screw locks
- Zinc plated steel shell matches connectors

#### Dimensions

Shell Size	Part Number	Dimensions (mm)						
		A	B	C	D	E	F	G
A	DA-20961	38.89	12.70	33.32	10.31	23.72	3.18	26.19
B	DB-20962	52.78	12.70	47.04	15.06	38.48	4.75	26.97

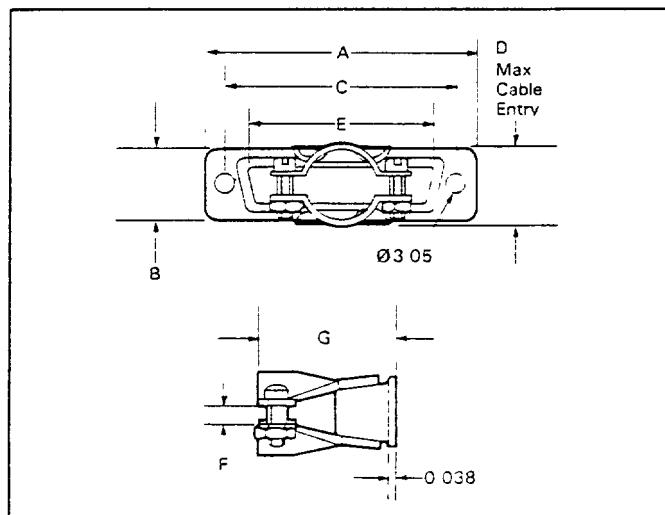

## Straight Clamp

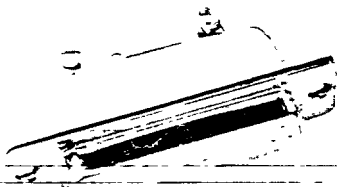

- Ideal for loose wire bundles
- Low profile
- Zinc plated steel shell matches connectors
- May be used with screw locks

Shell Size	Part Number	No. of Locking Screws Required	Dimensions (mm)					
			A	B	C	E	F	G
A	DA-19678-1	2	38.89	12.70	33.32	7.52	7.92	16.26
B	DB-19678-2	2	52.78	12.70	47.04	7.52	20.22	16.26
C	DC-19678-3	3	69.04	12.70	63.50	7.52	17.45	16.26
D	DD-19678-4	3	66.68	15.47	61.11	9.91	17.45	17.86

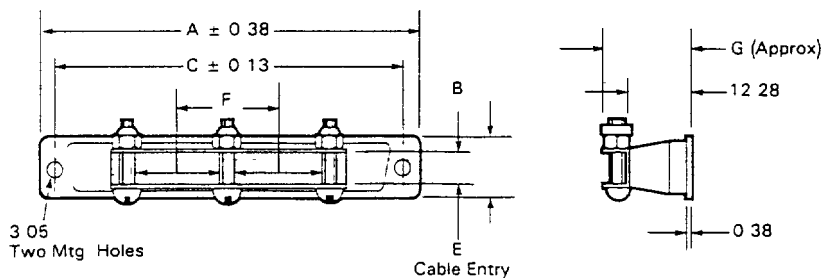

## Right Angle Clamp

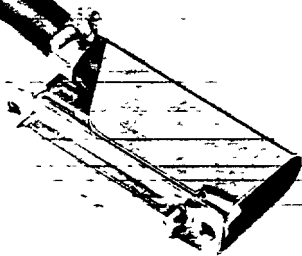

- Right angle outlet
- Cable clamp accepts a wide range of cable sizes
- Robust construction
- Yellow chromate plating on steel shell matches connectors

Shell Size	Part Number	Dimensions (mm)						
		A	B	C	E	F	G	H
E	DE-19977-5	30.56	18.24	24.99	11.10	11.10	11.89	7.14
A	DA-19977-1	38.89	18.24	33.32	11.10	11.10	11.89	7.14
B	DB-19977-2	52.78	24.59	47.04	11.10	15.88	11.89	7.14
C	DC-19977-3	69.04	30.15	63.50	11.10	20.62	11.89	7.14
D	DD-19977-4	66.68	31.75	61.11	14.27	23.01	13.49	8.71

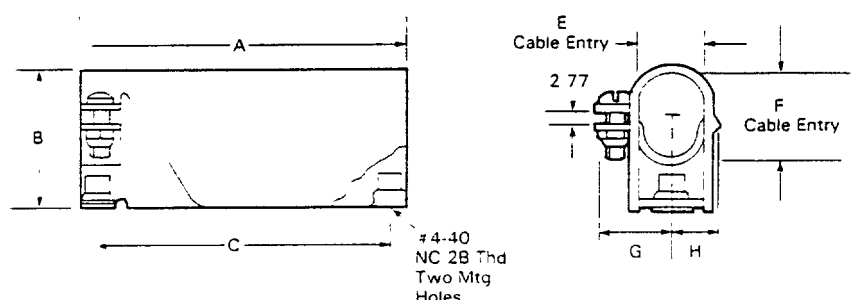

## Superfast Hood

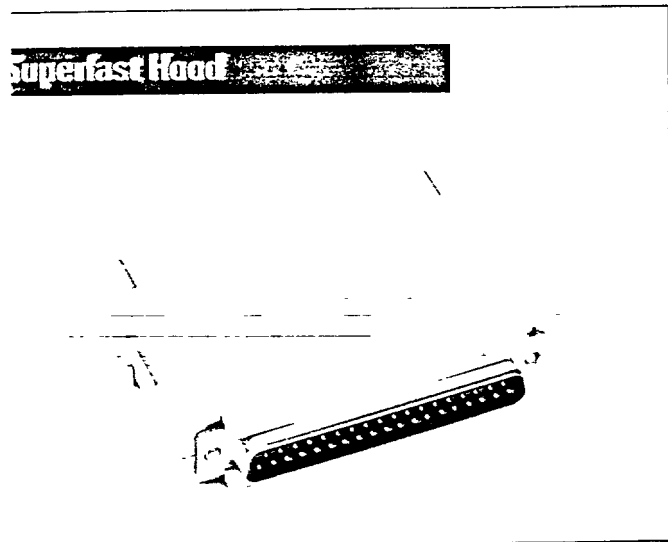

- Jack screws included
- Snap together hood for high speed assembly
- Integral strain relief
- High volume users may have their logo moulded in

Shell Size	Part Number	Dimensions (mm)		
		A	B	C
E	F08 00298 00 000 000	38.6	20.0	48.0
A	F08 00299 00 000 000	48.3	20.0	48.0
B	F08 00300 00 000 000	62.0	20.0	48.0
C	F08 00301 00 000 000	78.5	20.0	48.0

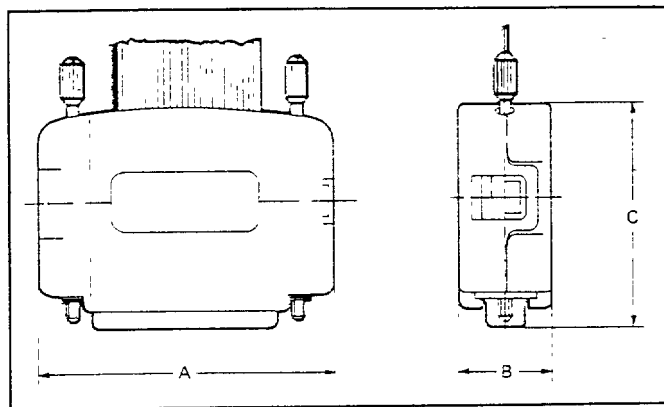

## Switching Shells

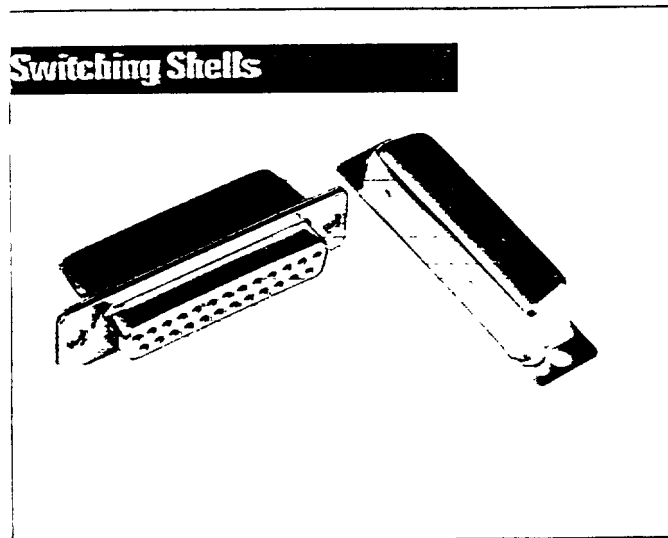

- Finished in yellow chromate to match the connectors
- May be used with screw locks

Shell Size	Part Number	Dimensions (mm)		
		A	B	C
A	DA-19678-6	38.89	12.70	33.32
B	DB-19678-7	52.78	12.70	47.04
C	DC-19678-8	69.04	12.70	63.50
D	DD-19678-9	66.68	15.47	61.11

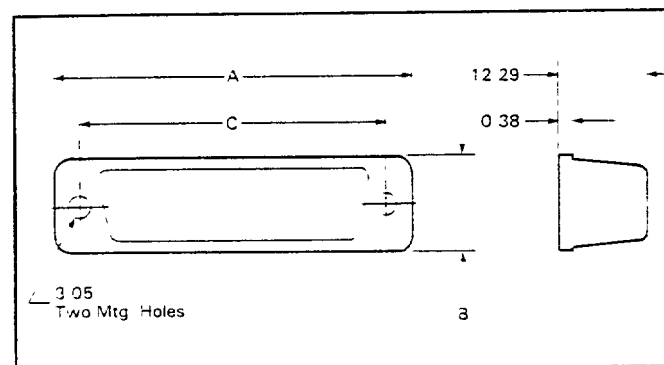

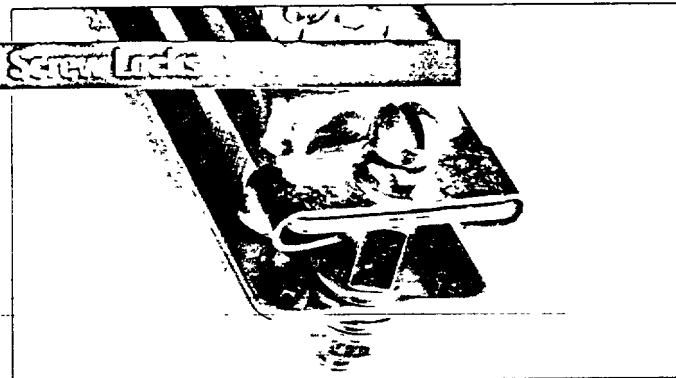

- Simple to use
- Robust
- Industry standard
- Zinc and yellow chromate plated

**Female**

Part Number Commercial	Part Number to MIL-C-24308	Dimension A
D20418-2	M24308/26-1	7.92 mm
D20418-39	M24308/26-2	15.88 mm

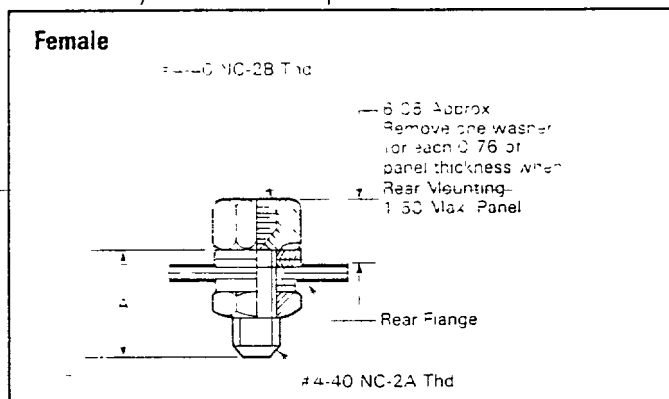

Both items are suitable for all shell sizes. D20418-2 is used in all applications except for those where the extra thread length of D20418-39 is needed.

**Male**

Shell Size	Plugs		Sockets		Dimension B (mm)
	Plug	Plug with Junction Shell	Socket	Socket with Junction Shell	
E	D20419-0 (M24308/25-9)*	D20419-16 (M24308/25-9)*	D20419-0 (M24308/25-9)*	D20419-16 (M24308/25-9)*	13.89
A	D20419-0 (M24308/25-9)*	D20419-16 (M24308/25-9)*	D20419-0 (M24308/25-9)*	D20419-16 (M24308/25-9)*	13.89
B	D20419-18 (M24308/25-9)*	D20419-21 (M24308/25-9)*	D20419-0 (M24308/25-9)*	D20419-16 (M24308/25-9)*	13.89
C	D20419-18 (M24308/25-9)*	D20419-21 (M24308/25-9)*	D20419-0 (M24308/25-9)*	D20419-16 (M24308/25-9)*	13.89
D	D20420-15 (M24308/25-10)*	D20420-15 (M24308/25-10)*	D20420-0 (M24308/25-10)*	D20420-12 (M24308/26-10)*	16.66

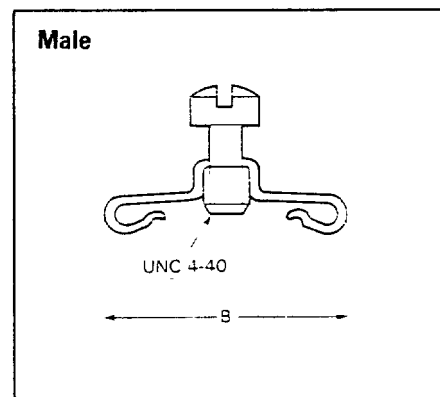

\*Military version These are dimensionally identical to the commercial items

Note:- Two screw lock assemblies are required per connector

For steel screw lock assemblies the maximum recommended assembly torques are:-

- Assembly of Female to Panel 0.9Nm
- Fixing of Male to Female 0.45Nm

## Slide Locks

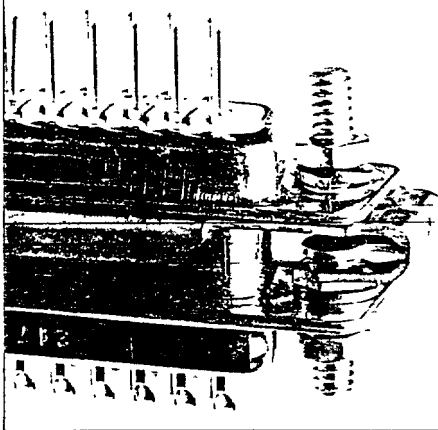

- Industry standard locking system
- No tools needed
- Easily used with 90° & straight outlets
- All parts are securely retained on the connector

Shell Size	Part Numbers		Dimensions (mm)		
	Lock Retainer	Lock Post	A	B	C
E	DE-51224-1	D53018	36.63	12.70	24.99
A	DA-51220-1	D53018	44.96	12.70	33.32
B	DB-51221-1	D53018	58.24	12.70	47.04
C	DC-51222-1	D53018	75.13	12.70	63.50
D	DD-51223-1	D53018	72.31	15.47	61.11

Note - Two lock post assemblies are required per connector

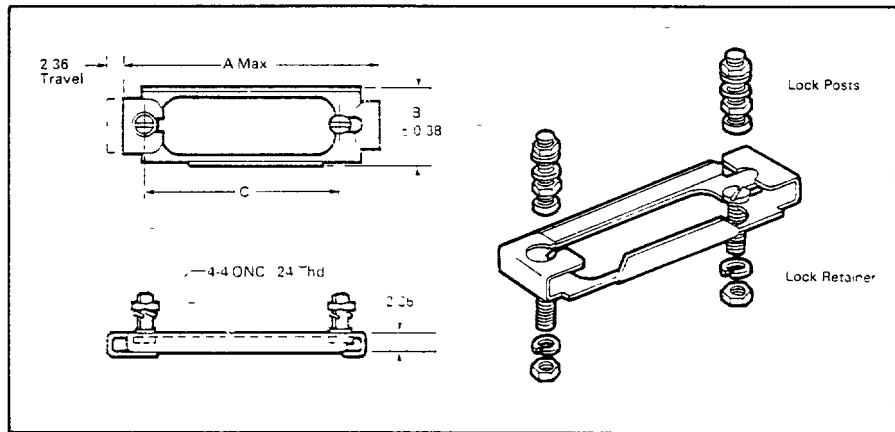

## Dust Caps

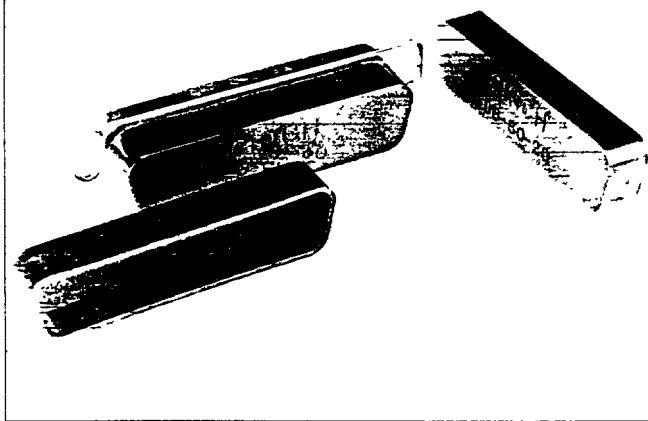

- Protects connector contacts
- Made from polyvinyl chloride for maximum performance

Shell Size	Part Number
E Plug	DE-60-20
E Socket	DE-59-20
A Plug	DA-60-20
A Socket	DA-59-20
B Plug	DB-60-20
B Socket	DB-59-20
C Plug	DC-60-20
C Socket	DC-59-20
D Plug	DD-60-20
D Socket	DD-59-20

### Semi Automatic Strip & Crimp Tool

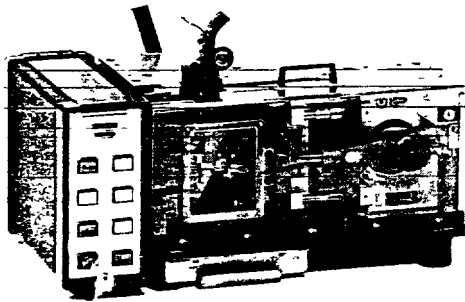

- Strips and crimps in one cycle
- Quiet operation
- Accepts wire gauges 20 - 32 AWG
- Easy setting
- Rapid reel change
- Contacts fed vertically to avoid stripping products falling into crimp area
- Fully electrically operated (no airline required)

#### Suitable for use with:-

Connector	Wire Sizes (AWG)	Part Number for Fully Equipped Machine
Econo DA	20 - 24	W01 00001 00 000 000
Econo DA	24 - 28	W01 00002 00 000 000
Econo C	20 - 28	W01 00003 00 000 000
Spacesaver	22 - 28	W01 00004 00 000 000
Spacesaver	28 - 32	W01 00005 00 000 000

### Hand Crimp Tool Reel Fed

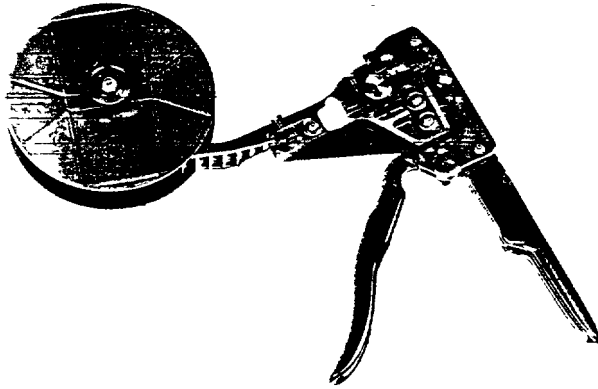

- Accepts contacts on carrier strip or reels of 300
- Contacts are automatically clipped from the carrier strip
- Convenient to use – contacts are held throughout the crimping operation
- Crimps both conductor and insulation in one operation

#### Suitable for use with:-

Connector	Wire Sizes (AWG)	Part Number for Hand Tool
Econo DA	20 - 28	W04 00001 00 000 000
Spacesaver	22 - 32	W04 00002 00 000 000

### Hand Crimp Tool – Individual Contacts

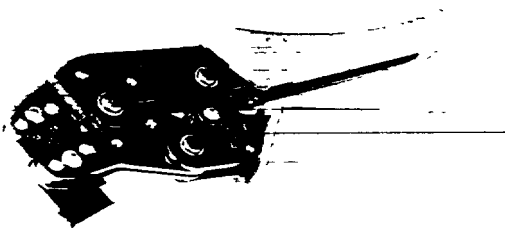

- Low cost
- Robust
- Easy to use
- Ideal for repairs

#### Suitable for use with:-

Connector	Wire Sizes (AWG)	Part Number for Hand Tool
Econo DA	20 - 28	W04 00003 00 000 000
Spacesaver	24 - 28	W04 00003 00 000 000

**Hand Crimp Tool - Long Tinned Contacts**

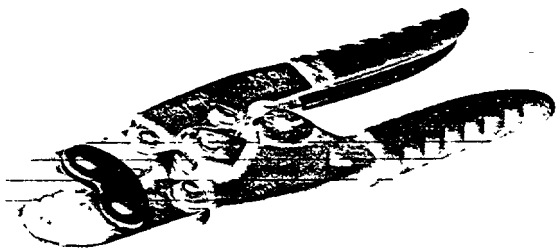

- Robust
- Easy to use

Suitable for use with:-

Connector	Wire Sizes (AWG)	Part Number for Hand Tool
Econo C	20 - 28	W04 59911 11 189 000

**Hand Crimp Tool - Turned Contacts**

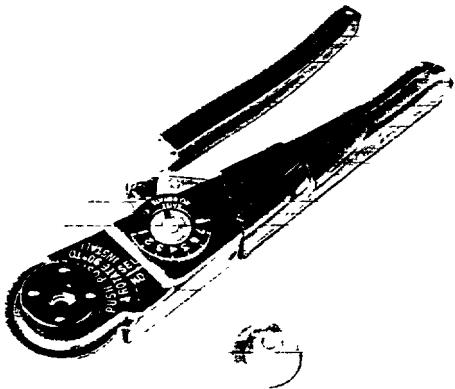

- Available to MIL spec
- For use with turned contacts

Suitable for use with:-

Connector	Wire Sizes (AWG)	Part Number for Tool Without Locator	Locator Part Number	
			Pin	Socket
Econo C	20 - 24	W04 59911 11 190 000	K155	
Series 3	20 - 24	W04 59911 11 190 000	K13-1	
Double Density DURA-CON	22 - 26	W04 59911 11 190 000	K154	K156

**Superfast Press**

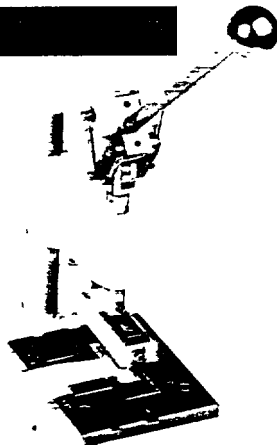

- High speed mass termination
- Quick tool change
- Rapid change of shell sizes

Suitable for use with:-

Connector	Tool Part Number	Description
Superfast IDC D	W03 00003 00 000 000	Complete Tool Set without Press
All Cinch flat cable connectors	W03 00004 00 000 000	Press with Base Plate.



### Auto Clinch

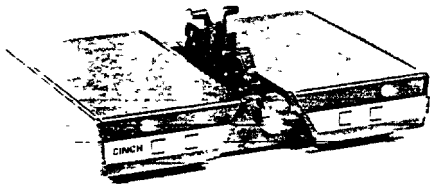

- Very high speed termination
- Can be equipped for metal or plastic shelled Super D
- Optional programming to load wires in required positions
- Colour code display available for accurate wire sequencing
- Common nest accommodates all four connector sizes
- Wires may be omitted where required
- Eliminates stripping
- Automatically cuts wire to length
- Other options available. Please consult factory

Suitable for use with:-

Connector	Wire Sizes (AWG)	Auto Clinch Part Number
Super D	24 - 26	W02 59911 11 432 000

### Certi Clinch

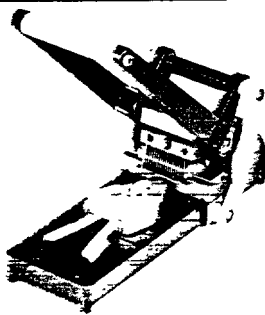

- Mass termination of individual wires
- High speed termination
- Eliminates wire stripping
- Automatically trims wires to length
- Fully portable
- One nest is suitable for 9, 15, 25 & 37 way connectors

Suitable for use with:-

Connector	Wire Sizes (AWG)	Certi Clinch Part Number
Metal Shell IDC	24 - 26	W03 59911 11 451 000
Super D	24 - 26	W03 59911 11 431 000

Conversion nest for converting metal shell type to all plastic W04 59898 99 100 000

### Uni Clinch



- Low cost
- Robust
- Ideal for field repairs
- Inserts single wires

Suitable for use with:-

Connector	Wire Sizes (AWG)	Uni Clinch Part Number
Metal Shell IDC	24 - 26	W04 59911 11 430 000
Super D	24 - 26	W04 59911 11 430 000

### Super D Stay Band Crimping Tool

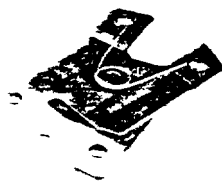

- Accommodates all Super D Stay Bands
- Easy to use

Suitable for use with:-

Connector	Tool Part Number
All Super D & Snap Together Hoods	W04 59911 11 434 000

### Low Cost Insertion/Extraction Tool

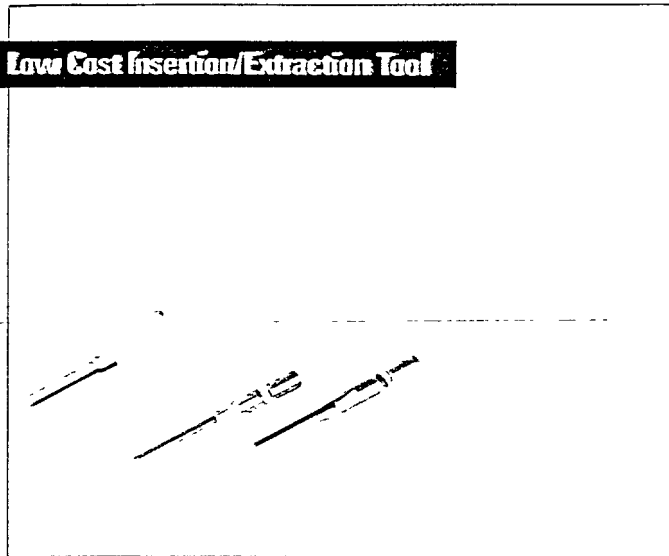

- Interchangeable inserts for various wire sizes
- Spare inserts may be stored in the handle

#### Suitable for use with:-

Connector	Wire Sizes (AWG)	Tool Part Number
Econo DA	20 - 28	W04 50240 19 060 000
Econo C	20 - 28	W04 50240 19 060 000
Series 3	20 - 24	W04 50240 19 060 000
Spacesaver	22 - 32	W04 50240-19 117 000
All the Above	20 - 32	W04 00004 00 000 000

### All Steel Extraction Tool

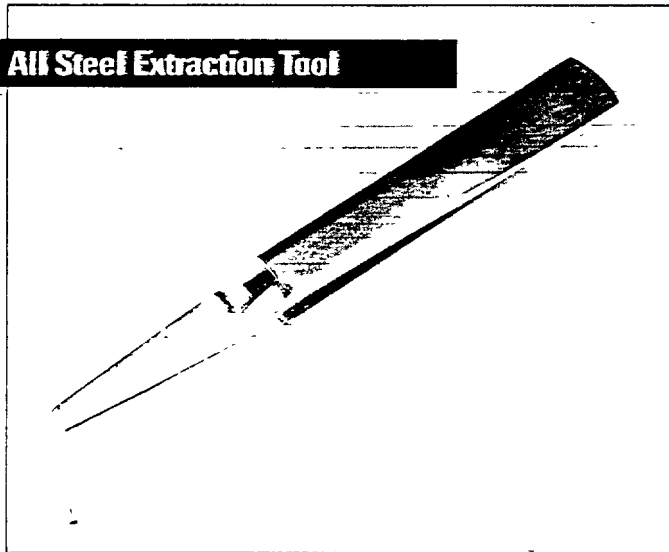

#### Suitable for use with:-

Connector	Wire Sizes (AWG)	Tool Part Number
Econo DA	20 - 28	W04 50240 15 002 000
Econo C	20 - 28	W04 50240 15 002 000
Series 3	20 - 24	W04 50240 15 002 000

### Plastic Insertion & Extraction Tool

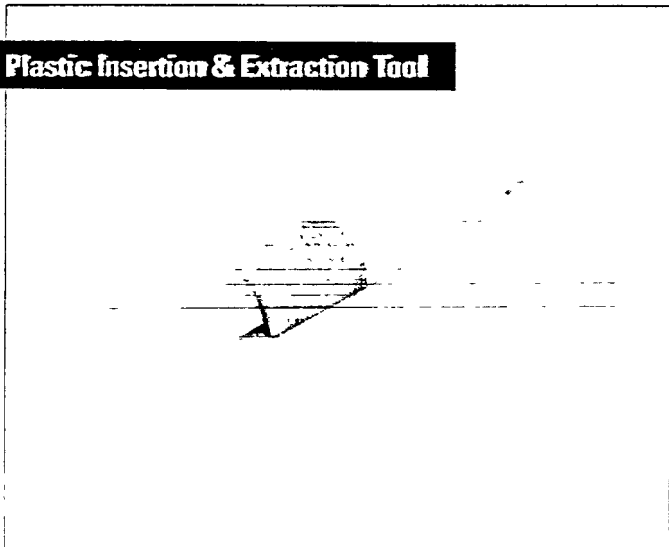

#### Suitable for use with:-

Connector	Wire Sizes (AWG)	Tool Part Number
Econo C	20 - 28	W04 59911 11 176 000
Series 3 (MIL-C-24308)	20 - 24	W04 59911 11 165 000
Series 3	20 - 24	W04 59911 11 150 000

**Coaxial & High Voltage Extraction Tool**

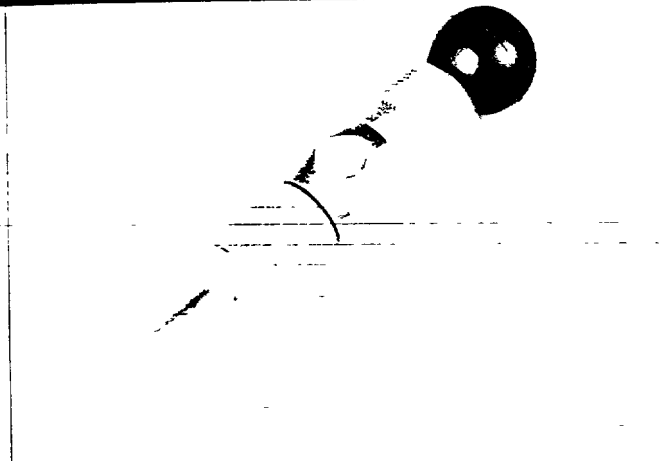

Suitable for use with:-

Connector	Tool Part Number
All Series 1 Coaxial & High Voltage Contacts	W04 59911 11 114 000

**Double Density DURA-CON Tools**

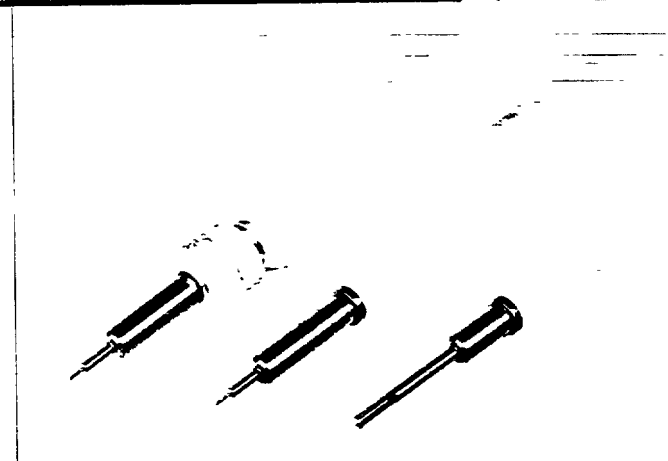

Description	Part Number
Kit: Handle, Insertion and Extraction Tools	W04 59911 11 386 000
Handle	W04 59898 99 054 000
Insertion Tool for Pin and Socket Contact	W04 59898 99 055 000
Extraction Tool for Pin Contact	W04 59898 99 056 000
Extraction Tool for Socket Contact	W04 59898 99 057 000

## X-ON Electronics

Largest Supplier of Electrical and Electronic Components

*Click to view similar products for [bel fuse manufacturer](#):*

Other Similar products are found below :

[P2404DB](#) [FC100V20A-G](#) [5SF 200-R](#) [010-0055](#) [M24308/1-12F](#) [M24308/2-336Z](#) [M24308/2-343Z](#) [M24308/3-21F](#) [70-1080](#) [73-6311-10](#) [73-6670-7](#) [PET2000-12-074NA](#) [PL1WC-026](#) [PL375C-201](#) [PL75-45BR](#) [PS-15201](#) [PS-15206](#) [PSAC-17312](#) [PSK3616-7](#) [QM48T40033-PDB0](#) [127-0692-001](#) [127-2701-602](#) [ADPL75-E1-UBJ20](#) [ADT-2540-7M-SMM-02](#) [DCB-3510-FF-SMA-02](#) [DCDM100CS](#) [DCDM-15S6E5-36.0K](#) [DCHM15SCBRPN-HT1](#) [131-8403-011](#) [RFI21-13](#) [RFI75-8-D3](#) [DDM50SA156](#) [131-3693-116](#) [DEME9S](#) [DEMM9SM](#) [DFC10U48D12](#) [140-0000-954](#) [141-3901-802](#) [142-0233-001](#) [AM2003-9](#) [142-0298-001](#) [14-5642](#) [146-0701-301](#) [MS24264R10T20PY](#) [MS24264R10T2PY-LC](#) [MS24264R10T5PY-LC](#) [MS24264R10T5SY-LC](#) [MS24264R14B15SN-LC](#) [MS24264R14T15SN](#) [MS24264R18B14SY-LC](#)