



TRADE PRICE LIST

January 2000

**GREASE
NIPPLE
BOXES**

Prices exclusive of VAT

ACCESSORY BOXES

Accessory boxes containing a selection of popular nipples and hydraulic connector.

Metric selection

54-7010

Containing:

10 x M6 x 1 STRAIGHT	HMM6/100
8 x M6 x 1 45° ANGLE	HMM6/100/45
8 x M6 x 1 90° ANGLE	HMM6/100/90
10 x M8 x 1 STRAIGHT	HMM8/100
8 x M8 x 1 45° ANGLE	HMM8/100/45
8 x M8 x 1 90° ANGLE	HMM 8/100/90
10x M10 x 1 STRAIGHT	HMM10/100
8 x M10 x 1 45° ANGLE	HMM10/100/45
8 x M10 x 1 90° ANGLE	HMM10/100/90
1 x HYDRAULIC CONNECTOR	HC5

Imperial selection

54-7011

Containing:

20 x 1/8" BSP STRAIGHT	HP2
6 x 1/4" BSP STRAIGHT	HP4
10 x 1/4" UNF STRAIGHT	HUF4
10 x 1/4" UNF STRAIGHT (LONG)	HUF4L
10 x 1/8" BSP 90° ANGLE	HP2/90
5 x 1/4" BSP 90° ANGLE	HP4/90
10 x 1/4" UNF 45° ANGLE	HUF4/45
10 x 1/4" UNF 90° ANGLE	HUF4/90
1 x HYDRAULIC CONNECTOR	HC5

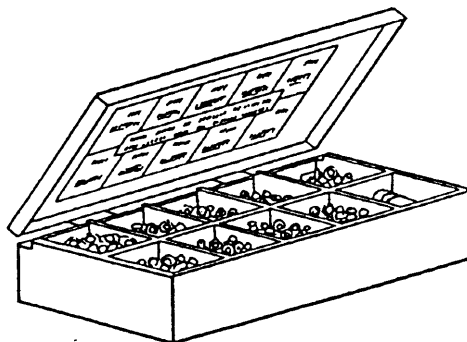

NIPPLES & ACCESSORIES

BAYONET NIPPLES ①

SIZE	NUMBER
1/8" BSP	BP2

LIMITED SUPPLY PLUGS ②

SIZE	NIPPLE TYPE	CAT. NUMBER
1/8" BSP	HYDRAULIC	LSPHP2
1/8" BSP	HOOK-ON	LSPHOP2
1/8" BSP	HOOK-ON†	LSPHOP2A

BALL SPRING OILERS ③

SIZE	CAT. NUMBER
3/16" drive fit	BO3
1/4" drive fit	BO4
5/16" drive fit	BO5
3/8" drive fit	BO6
1/2" drive fit	BO8

EXTENSION PIECES ④

SIZE	CAT. NUMBER	
	CYLINDRICAL	HEXAGONAL
1/8" BSP x 1/2"	CE 21	CE 21/HEX
1/8" BSP x 1"	CE 22	CE 22/HEX
1/4" BSP x 1/2"	CE 41	—
1/4" BSP x 1"	CE 42	—
3/8" BSF x 1/2"	CEF 61	—
3/8" BSF x 1"	CEF 62	CEF 62/HEX

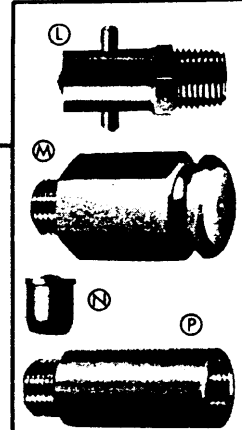

PLASTIC IDENTIFICATION WASHERS

SIZE	CAT. NUMBER	
	RED	YELLOW
1/8" BSP	PW2R	PW2Y
1/4" BSP	PW4R	PW4Y
1/4" BSF	PWF4R	PWF4Y
5/16" BSF	PWF5R	PWF5Y

'NIPCAP' PLASTIC COVERS FOR HYDRAULIC NIPPLES

COLOUR	CAT. NUMBER	
	PLAIN ⑥	WITH COLLAR ⑦
RED	NCP/R	NCP/RC/R
YELLOW	NCP/Y	NCP/RC/Y
BLUE	NCP/B	NCP/RC/B
GREEN	NCP/G	NCP/RC/G

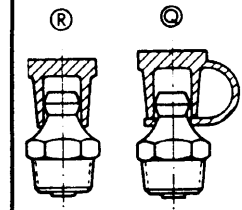

SCREW DOWN LUBRICATORS ⑧

CAPACITY cc	'A' BSP	CAT. NUMBER	B Ø	C FULL	C EMPTY	D	E A/F
3	1/8"	SL1P2	19	38	26	5.5	12
5	1/4"	SL2P2	22	44	30	6	13
5	1/4"	SL2P4	22	44	30	9.5	17.5
25	1/4"	SL4P4	41	51	32	9.5	17.5
70	1/4"	SL6P4	59	64	38	9.5	17.5

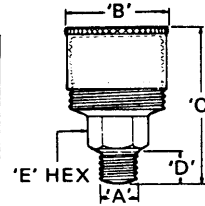

CENTRALIZED NIPPLE SYSTEM

On fixed plant or machinery with numerous lubrication points it is often the practice to group the nipples at a convenient central location and then run pipework to the individual bearings. This method has the advantage of making all points easily accessible and permits lubrication to be carried out safely while the machinery is in motion. A range of battery plate adaptors with compression fittings to fit various pipe sizes are available for this purpose. The required types of nipples are screwed into the female ends of the battery plate adaptors and the adaptors are then mounted on a suitably drilled plate. Connections at the bearings can be made using the straight or elbow connectors illustrated. (For full range of adaptors and fittings, including metric sizes, see Leaflet Reference CF 00.)

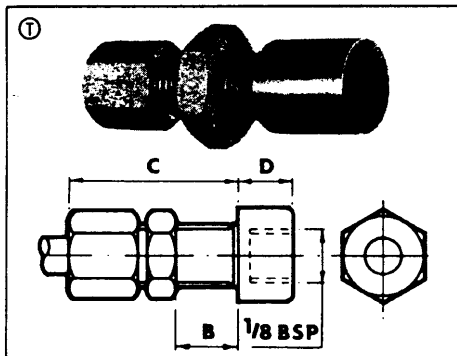

BATTERY PLATE ADAPTORS ①

TUBE O/D	DIMENSIONS				CAT. NUMBER
	B	C	D	CLEAR HOLE	
3/16"	.31	1.00	.50	.44	BPA 3/1
3/16"	.56	1.25	.50	.44	BPA 3/2
1/4"	.50	1.25	.37	.50	BPA 4/1
1/4"	.75	1.50	.37	.50	BPA 4/2
6mm	.50	1.25	.37	.50	BPA 6M/1
6mm	.75	1.50	.37	.50	BPA 6M/2

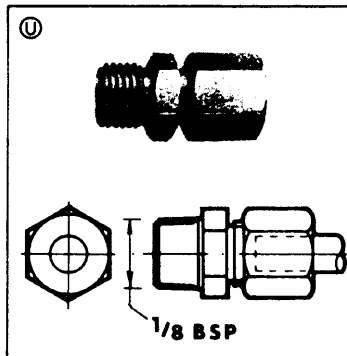

STRAIGHT CONNECTORS ②

TUBE O/D	CAT. NUMBER
3/16"	SC 32
1/4"	SC 42
6mm	SC 6M2

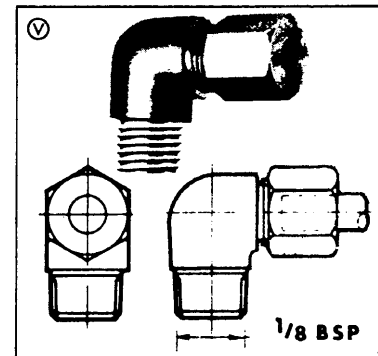

ELBOW CONNECTORS ③

TUBE O/D	CAT. NUMBER
3/16"	EC 32
1/4"	EC 42
6mm	EC 6M2

† Bronze Ball and Spring

NIPPLES

Unless otherwise indicated, nipples are of electro plated steel construction and incorporate check valves of the surface seal type to prevent contamination and back-flow of lubricant. Hydraulic and Push-on nipples are hardened for increased wear resistance. They conform generally to BSS 1486.

HYDRAULIC NIPPLES

INCH SIZES	CATALOGUE NUMBERS		
	STRAIGHT (A)	45° ANGLE (B)	90° ANGLE (C)
1/8" BSP	HP2	HP2/45	HP2/90
1/8" BSP short thread	HP2S	—	—
1/8" ANPT	HB2	HB2/45	HB2/90
3/16" BSF	HF3	—	—
3/16" drive fit	HDFV3	—	—
3/16" drive fit*	HDF3	—	—
1/4" BSF	HF4	HF4/45	HF4/90
1/4" BSF long shank	HF4L	—	—
1/4" UNF	HUF4	HUF4/45	HUF4/90
1/4" UNF long shank	HUF4L	—	—
1/4" Whitworth	HW4	HW4/45	HW4/90
1/4" drive fit	HDFV4	HDFV4/45	HDFV4/90
1/4" drive fit*	HDF4	—	—
1/4" BSP	HP4	HP4/45	HP4/90
5/16" BSF	HF5	HF5/45	HF5/90
5/16" UNF	HUF5	HUF5/45	HUF5/90
5/16" Whitworth	HW5	HW5/45	—
5/16" drive fit	HDFV5	HDFV5/45	HDFV5/90
5/16" drive fit*	HDF5	—	—
3/8" BSF	HF6	HF6/45	HF6/90
3/8" UNF	HUF6	HUF6/45	HUF6/90
METRIC SIZES			
6mm drive fit	HDFVMM6	HDFVMM6/45	HDFVMM6/90
6mm drive fit*	HDFMM6	—	—
6mm x 1mm	HMM6/100	HMM6/100/45	HMM6/100/90
8mm drive fit	HDFVMM8	HDFVMM8/45	HDFVMM8/90
8mm drive fit*	HDFMM8	—	—
8mm x 1mm	HMM8/100	HMM8/100/45	HMM8/100/90
8mm x 1.25mm	HMM8/125	HMM8/125/45	HMM8/125/90
10mm x 1mm	HMM10/100	HMM10/100/45	HMM10/100/90
10mm x 1.5mm	HMM10/150	HMM10/150/45	HMM10/150/90

HOOK-ON NIPPLES

INCH SIZES	CATALOGUE NUMBERS			
	STANDARD (E)		INDUSTRIAL (F)	GIANT (G)
	STEEL	BRASS		
1/8" BSP	HOP2	HOP2B	HOIP2	—
1/8" BSP	—	HOP2A†	—	—
1/8" BSP long shank	HOP2L	—	—	—
1/4" BSF	HOF4	—	—	—
1/4" BSP	HOP4	HOP4B	HOIP4	GB P4
1/4" BSP	—	HOP4A†	—	—
5/16" BSF	HOF5	—	—	—
3/8" BSF	HOF6	HOF6B	—	—
3/8" BSP	—	—	HOIP6	GB P6
3/8" ANPT	—	—	—	GB B6
METRIC SIZES				
8mm x 1mm	HOMM8/100	—	—	—
8mm x 1.25mm	HOMM8/125	—	—	—
10mm x 1mm	HOMM10/100	—	—	—
10mm x 1.50mm	HOMM10/150	—	—	—

PUSH-ON NIPPLES

SIZE	CAT. NUMBER		CONCAVE NIPPLES (K)	
	STRAIGHT (H)	ANGLE (J)	SIZE	CAT. NUMBER
1/8" BSP	PP2	PP2/45	1/8" BSP	LP2
3/16" BSF	PF3	—	1/4" BSP	LP4
3/16" drive fit	PDF3	—	1/4" drive fit	LDFV4
1/4" BSF	PF4	PF4/45		
1/4" BSF long shank	PF4L	—		
1/4" UNF	PUF4	—		
1/4" UNF long shank	PUF4L	—		
1/4" drive fit*	PDF4	—		

(A)



(B)



(C)



(E)



(F)



(G)



(H)



(J)



(K)



* No Ball & Spring

† Bronze Ball and Spring

MPQ+



Hook-on connector heavy duty

HOC2

1



Slide-on connector

SOC5

1



Slide-on/Hook-on connector

SOC1

1



Giant hook-on connector

GHOC1

1

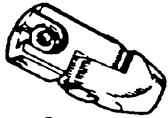

Slide-on connector with knuckle joint

SOC2

1



Rotary connector

RC1

1

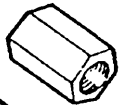

1/8" BSP Adaptor

S22

1

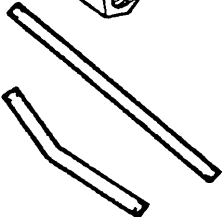

Adaptor nut 1/8" BSP - 1/4" BSP

AN42

1



6" Straight rigid tube

SRT6

1

10" Straight rigid tube

SRT10

1

6" Bent rigid tube

BRT6

1

10" Bent rigid tube

BRT10

1



High pressure rubber flexible tube 9" long

RF9

5

High pressure rubber flexible tube 12" long

RF12

5

High pressure rubber flexible tube 18" long

RF18

5

High pressure rubber flexible tube 24" long

RF24

1

Heavy duty polymer flexible 9" long

RF9/VS

5

Heavy duty polymer flexible 12" long

RF12/VS

5

Heavy duty polymer flexible 18" long

RF18/VS

5

High pressure nylon flexible tube 9" long

RF9/N

5

High pressure nylon flexible tube 12" long

RF12/N

5

High pressure nylon flexible tube 18" long

RF18/N

5

High pressure nylon flexible tube 24" long

RF24/N

1

(All grease gun hoses have 1/8" BSP ends)

Snap-on flexible extension

54-2048

1



Hand Grease Guns - Telescopic Type

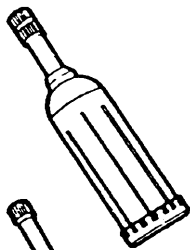

60cc Capacity with push-on connector. Metal body.

MPO 5

MPQH

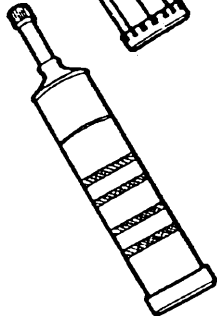

120cc capacity with universal connector. Plastic body.

APO/U 5

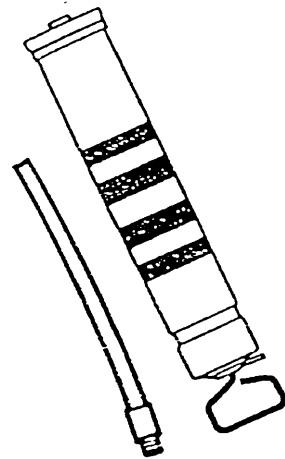

135cc Capacity with universal connector. Metal body.

NGU 5

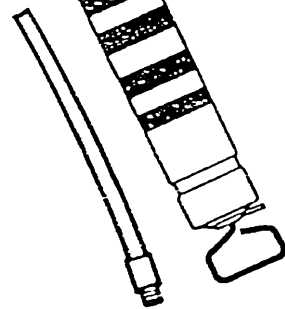

Suction oil gun-plunger operated for gear box filling and emptying etc. complete with flexible plastic hose.

SOG1 1

Accessories



Push-on connector

POC1 5



4 Jaw Hydraulic connector heavy duty type

HC1 10

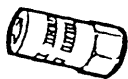

4 Jaw Hydraulic connector standard type

HC5 10

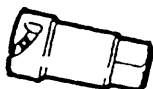

Bayonet connector

BC1 1



Lub connector

LC1 1



Conical connector

CC1 5



Hook-on connector

HOC1 5

BARREL PUMPS

LOW COST PLASTIC DRUM PUMP

500mm riser -
Part No. 55-1212 Steel Riser
55-1214 Polythene Riser
1000mm riser -
Part No. 55-1439 Steel Riser
55-1440 Polythene Riser



- Available with 1/2 or 1 metre riser to fit drums of up to 205 litres.
 - Cost effective and simple to operate.
 - Handles a wide range of lubricating oils, solvents and anti-freeze.
- Available with a range of drum adaptors.
Ask your local supplier for full details.

CAST IRON ROTARY PUMP

Part No. Heavy Oils - 55-1430
Light Oils - 55-1436

- Designed for bulk storage and 205 litre drums.
- Durable by design with a flexi-hose to either syphon or pump 1/4 litre per turn.
- A choice of two models suitable for heavy lubricating oils or light oils and fuels.



NYLON BARREL & DRUM PUMP

Part No. 55-1443
● Ideal for lubricating oils and anti-freeze.
● Dual threaded for plastic and steel drums up to 205 litres.
● The lockable handle dispenses 1/2 litre per stroke.
● Non-drip nozzle. Maintenance free design.

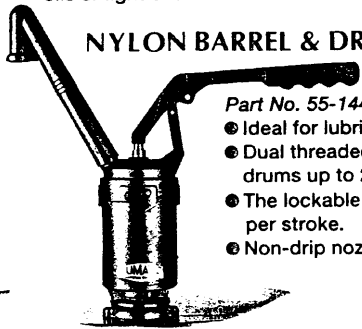

STEEL BODIED LEVER PUMP

Part No. 55-1426
● Adjustable riser to suit drums up to 205 litres.
● Dispenses a 1/3 of a litre per stroke.
● Handles lubricating oils and non-corrosive liquids.

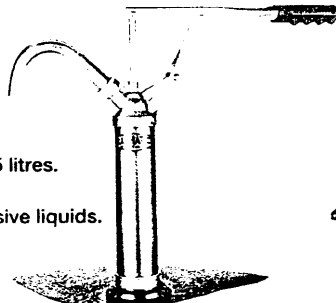

DRUM TAPS



Part No. 91-9012
(Metal)

- Tamperproof lever action tap with 3/4 inch B.S.P.T. fitting.
- Handles non-corrosive liquids and petroleum products.

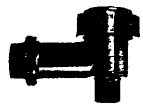

DRUM TAPS

Part No. 91-9011
(Plastic)

- Suitable for most oil based products.
- 3/4 inch B.S.P.T. fitting.

MEASURES & FUNNELS

All Lumatic measures and funnels are manufactured to the highest standards and are designed to meet the needs of the garage trade and industry.

Completely unaffected by oils and fuels, solvents and acids, each measure and funnel has an easy to read litre/pints graduation and a fast pour without surge feature.

STANDARD MEASURE

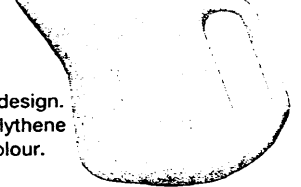

1/2 litre - Part No. M5
1 litre - Part No. M10
5 litres - Part No. M50

- Good value and general purpose design.
- Moulded in tough high density polythene which will not crack, dent or discolour.

FLEXISPOUT MEASURE

1 litre - Part No. MF10
2 litres - Part No. MF20
3 litres - Part No. MF30
5 litres - Part No. MF50

- Flexispout overcomes difficult filling points instantly.

SELF DRAINING MEASURE



1 litre - Part No. SDM10

- Can be tipped up and left to drain unattended, without spillage.

FLEXIBLE EXTENSION FUNNEL

100mm Diameter - Part No. FS4
190mm Diameter - Part No. FS7.5
230mm Diameter - Part No. FS9

- Fitted with an integral filter.
- Designed with an anti-splash rim and on the 190mm and 230mm funnels a moulded finger grip adds to safer handling.

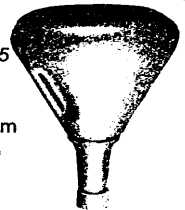

GARAGE FUNNEL

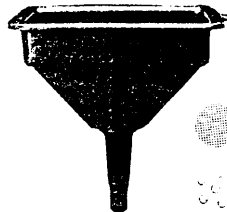

12" high - Part No. FG12

For lubricants - Part No. FGFL

Diesell/water separator - Part No. FGFD

- Strong and reliable with interchangeable filters.
- The filters are easy to remove and clean.

For further details and prices please speak to your local supplier who will be pleased to deal with your enquiry promptly.



FLUID HANDLING IN MOTION

LUMATIC (GA) LIMITED

HASTINGS, EAST SUSSEX TN34 1YS FAX (0424) 429926

Telephone: (0424) 436343

X-ON Electronics

Largest Supplier of Electrical and Electronic Components

Click to view similar products for [lumatic lubrication](#) manufacturer:

Other Similar products are found below :

[LUMATIC LUBRICATION](#)