

# Temperature Meter K3MA-L

CSM\_K3MA-L\_DS\_E\_11\_1



## Highly Visible LCD Display with 2-color (Red and Green) LEDs

- Wide input range - select from two types of platinum-resistance thermometers and ten types of thermocouples.
- Front-panel key operation for easy setting.
- Average processing function suppresses flicker.
- Temperature input shift and temperature unit selection functions.
- Easy confirmation of max/min display.
- Short 80-mm depth (measured from edge of face plate).
- Finger protective cover (standard equipment) protects against electric shock.
- Water- and dust-proof NEMA4X (IP66 equivalent) front panel.
- Recognized to conform to U.S. and Canadian requirements under the Component Recognition Program of UL.
- CE marking.



For the most recent information on models that have been certified for safety standards, refer to your OMRON website.

 Refer to *Safety Precautions for All Digital Panel Meters*.

## Model Number Structure

### Model Number Legend

K3MA-L-   
1 2 3

#### 1. Input Type

L: Platinum-resistance thermometer or thermocouple

#### 2. Output Type

None: No output

C: With relay contact output (SPDT)

#### 3. Supply Voltage

100-240VAC: 100 to 240 VAC

24VAC/VDC: 24 VAC/VDC

## Ordering Information

### List of Models

Input type	Supply voltage	Output	Model
Platinum-resistance thermometer or thermocouple	100 to 240 VAC	None	K3MA-L 100-240VAC
		1 relay contact output (SPDT)	K3MA-L-C 100-240VAC
	24 VAC/VDC	None	K3MA-L 24VAC/VDC
		1 relay contact output (SPDT)	K3MA-L-C 24VAC/VDC



## ■ Characteristics

Indication accuracy (at 23±5°C) (See note.)	Thermocouple: (±0.5% of indication value or ±1°C, whichever greater) ±1 digit max. Platinum-resistance thermometer: (±0.5% of indication value or ±1°C, whichever greater) ±1 digit max.
Input	Thermocouple: K, J, T, E, L, U, N, R, S, B Platinum-resistance thermometer: JPt100, Pt100
Measurement method	Double integral method
Sampling period	500 ms
Display refresh period	Sampling period (sampling times multiplied by number of averaging times if average processing is selected.)
Max. displayed digits	4 digits (–1999 to 9999)
Display	7-segment digital display, Character height: 14.2 mm
Polarity display	“–” is displayed automatically with a negative input signal.
Zero display	Leading zeros are not displayed.
Input shift	Input shift equivalent to the setting value supported for all points within the sensor measurement range.
Hold function	Max hold (maximum value), Min hold (minimum value)
Hysteresis setting	Programmable with front-panel key inputs (0001 to 9999).
Other functions	Display color change (green (red), green, red (green), red) Average processing (simple average OFF/2/4/8 operations) Setting change lockout Parameter initialization
Output	Relay contact (SPDT)
Delay in comparative outputs	1 s max.
Degree of protection	Front panel: NEMA4X for indoor use (equivalent to IP66) Rear case: IEC standard IP20 Terminals: IEC standard IP00 + finger protection (VDE0106/100)
Memory protection	Non-volatile memory (EEPROM) (possible to rewrite 100,000 times) (with terminal cover attached)

**Note:** The indication accuracy of the K thermocouple at a temperature of –200 to 1300°C is ±2°C ±1 digit maximum.  
The indication accuracy of the T and N thermocouples at a temperature of –100°C or less is ±2°C ±1 digit maximum.  
The indication accuracy of the U and L thermocouples at any temperature is ±2°C ±1 digit maximum.  
The indication accuracy of the B thermocouple at a temperature of 400°C or less is unrestricted.  
The indication accuracy of the R and S thermocouples at a temperature of 200°C or less is ±3°C ±1 digit maximum.

## ■ Measuring Ranges

### Platinum-resistance Thermometer

Input		Pt100			JPt100	
Range	°C	–200 to 850	–199.9 to 500.0	0.0 to 100.0	–199.9 to 500.0	0.0 to 100.0
	°F	–300 to 1500	–199.9 to 900.0	0.0 to 210.0	–199.9 to 900.0	0.0 to 210.0
Parameter		0	1	2	3	4

### Thermocouple

Input		K		J		T		E	L	U		N	R	S	B
Range	°C	–200 to 1300	–20.0 to 500.0	–100 to 850	–20.0 to 400.0	–200 to 400	–199.9 to 400.0	0 to 600	–100 to 850	–200 to 400	–199.9 to 400.0	–200 to 1300	0 to 1700	0 to 1700	100 to 1800
	°F	–300 to 2300	0.0 to 900.0	–100 to 1500	0.0 to 750	–300 to 700	–199.9 to 700.0	0 to 1100	–100 to 1500	–300 to 700	–199.9 to 700.0	–300 to 2300	0 to 3000	0 to 3000	300 to 3200
Parameter		5	6	7	8	9	10	11	12	13	14	15	16	17	18

## ■ Input/Output Ratings

### Relay Contact Output

Item	Resistive load (cosφ = 1)	Inductive load (cosφ = 0.4, L/R = 7 ms)
Rated load (UL ratings)	5 A at 250 VAC, 5 A at 30 VDC	1.5 A at 250 VAC, 1.5 A at 30 VDC
Min. permissible load (P level, reference value)	10 mA at 5 VDC	
Mechanical life	20,000,000 times min.	
Electrical life	100,000 times min.	

# Connections

## Terminal Arrangement

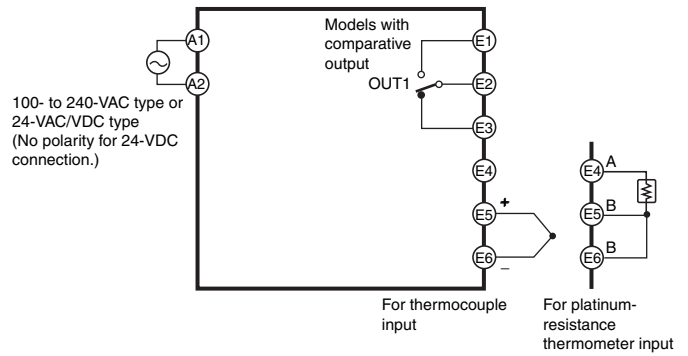
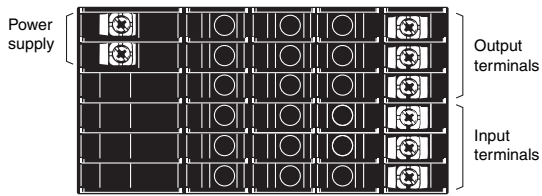

Terminal No.	Name	Description
A1 - A2	Operation power	Connects the operation power supply.
E4 - E6 - E5	Thermocouple or platinum-resistance thermometer input	Connects the thermocouple or platinum-resistance thermometer input.
E1 , E2 - E3	Outputs	Outputs the relay outputs.

## Block Diagram

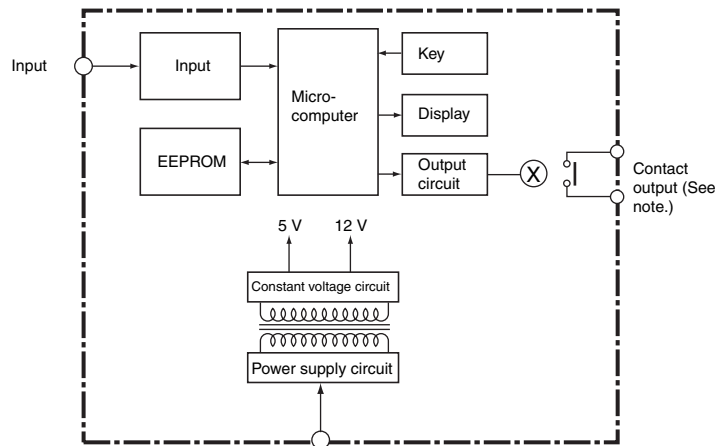

Note: Relay output models only.

# Operation

## ■ Main Functions

### Input Types and Ranges

Parameter	Setting	Input type	Meaning		
In-t	0	Platinum-resistance thermometer	Pt100	-200 to 850°C	-300 to 1500°F
	1			-199.9 to 500.0°C	-1999 to 900.0°F
	2			0.0 to 100.0°C	0.0 to 210.0°F
	3		JPt100	-199.9 to 500.0°C	-199.9 to 900.0°F
	4	0.0 to 100.0°C		0.0 to 210.0°F	
	5	Thermocouple	K	-200 to 1300°C	-300 to 2300°F
	6			-20.0 to 500.0°C	0.0 to 900.0°F
	7		J	-100 to 850°C	-100 to 1500°F
	8			-20.0 to 400.0°C	0.0 to 750.0°F
	9		T	-200 to 400°C	-300 to 700°F
	10			-199.9 to 400.0°C	-199.9 to 700.0°F
	11		E	0 to 600°C	0 to 1100°F
	12		L	-100 to 850°C	-100 to 1500°F
	13		U	-200 to 400°C	-300 to 700°F
	14			-199.9 to 400.0°C	-199.9 to 700.0°F
	15		N	-200 to 1300°C	-300 to 2300°F
	16		R	0 to 1700°C	0 to 3000°F
	17		S	0 to 1700°C	0 to 3000°F
18	B		100 to 1800°C	300 to 3200°F	

**Note:** The initial value is "5: thermocouple K (-200 to 1300°C/-300 to 2300°F)."

### Temperature Unit Selection

Either centigrade (°C) or fahrenheit (°F) can be selected as the temperature unit.

Parameter	Setting	Meaning
d-U	C	Display in °C.
	F	Display in °F.

- Lower limit (Low Acting):  
The output is turned ON when the measurement value is less than its set value.
- Upper and lower limits (Outside Band Acting):  
An upper limit (H set value) and lower limit (L set value) can be set independently.  
The output is turned ON when the measurement value is greater than the upper-limit set value or less than the lower-limit set value.

### OUT Types (Comparative Output Models Only)

OUT 1 can be set to operate in one of the three following modes in accordance with the compared values:

- Upper limit (High Acting):  
The output is turned ON when the measurement value is greater than its set value.

Parameter	Setting	Meaning
OUT 1-t	H $\bar{L}$	Upper limit: Alarm operates at upper limit.
	L $\bar{O}$	Lower limit: Alarm operates at lower limit.
	H $\bar{L}$ -L $\bar{O}$	Upper and lower limits: Alarm operates at upper and lower limits.

#### Upper Limit (High Acting)

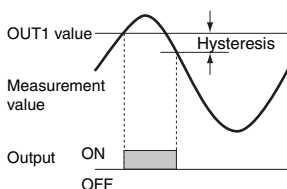

#### Lower Limit (Low Acting)

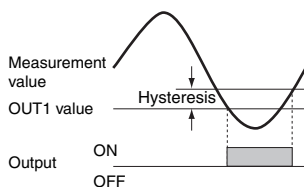

#### Upper and Lower Limits (Outside Band Acting)

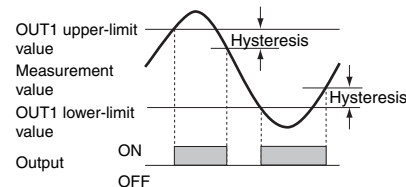

## Temperature Input Shift

Input shift equivalent to the setting value supported for all points within the sensor measurement range.

Parameter	Setting
$\bar{c}n5$	- 1999 to 9999

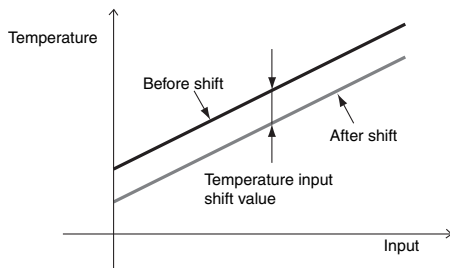

## Parameter Initialization

This function returns all of the parameters to their initial values.

Parameter	Setting	Meaning
$\bar{c}n4t$	$\bar{o}ff$	---
	$\bar{o}n$	Initializes all parameters.

Use this to reset the K3MA-L after returning it to its factory-set condition.

## Average Processing

Average processing stabilizes displayed values to minimize flicker by averaging the fluctuating input signals. Average processing can be performed for the measurement values in either of four steps (OFF, 2 times, 4 times, or 8 times).

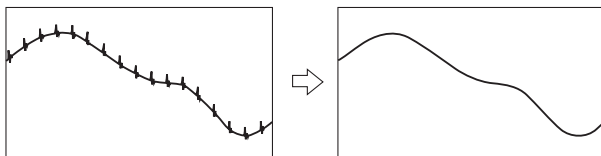

This is useful for ignoring rapid fluctuations, e.g., eliminating spike noise.

## Hysteresis (Comparative Output Models Only)

The hysteresis of comparative outputs can be set to prevent chattering in the output when the measurement value fluctuates finely near the OUT value.

### Upper limit (high acting)

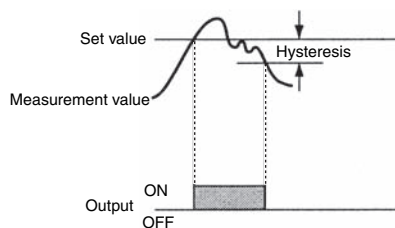

## Changing the Display Color

The color of the value displayed can be set to either red or green. For comparative output models, the display color can be set to change from green to red, or from red to green, according to the status of the comparison criterion.

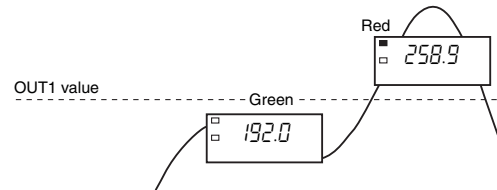

## Display Auto-return Time

This function automatically returns the display to the operation level's current value if no keys are pressed for a preset time (called the display auto-return time).

## Move-to-Protect-Level Time

The time required to shift to the protect level can be set as desired.

## MAX/MIN Display

The maximum and minimum measurement (display) values from the time the power is turned ON until the current time can be stored and displayed. This is useful, for example, when measuring the maximum value.

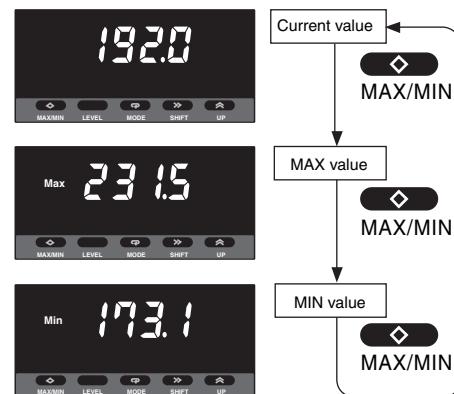

# Nomenclature

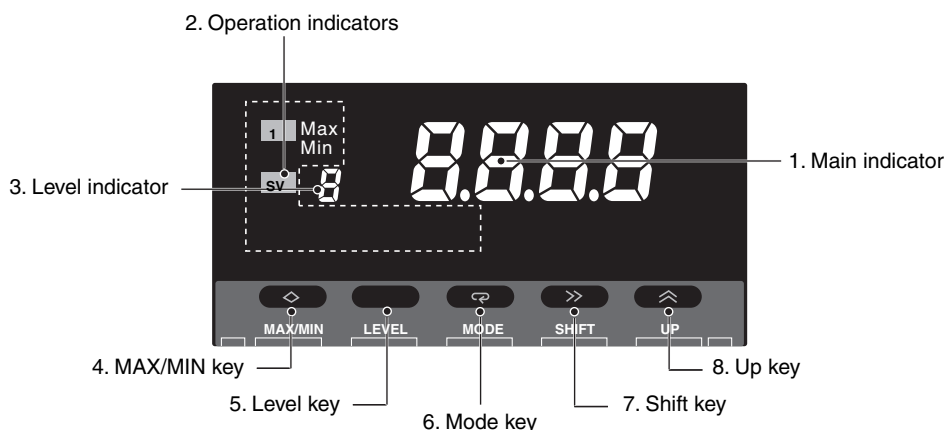

Name	Functions	
1. Main indicator	Displays current values, parameters, and set values.	
2. Operation indicators	1	Lit when output 1 is ON.
	SV	Lit when a set value is being displayed or changed.
	Max	Lit when the main indicator is showing the MAX value.
	Min	Lit when the main indicator is showing the MIN value.
3. Level indicator	Displays the current level that the K3MA-L is in. (See below for details.)	
4. MAX/MIN Key	Used to display the MAX and MIN values when a measurement value is being displayed.	
5. Level Key	Used to change the level.	
6. Mode Key	Used to allow the main indicator to indicate parameters sequentially.	
7. Shift Key	Used to enable a set value to be changed. When changing a set value, this key is used to move along the digits.	
8. Up Key	Used to change a set value. Used to set or clear a forced-zero function when a measurement value is being displayed.	

Level indicator	Level
$P$	Protect
Not lit	Operation
$R$	Adjustment
$S$	Initial setting
$F$	Advanced-function setting

## Dimensions

(Unit:mm)

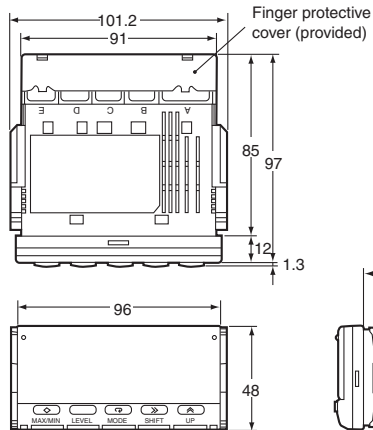

Main indicator character size

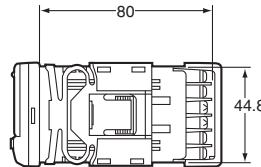
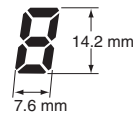

Panel cut-out

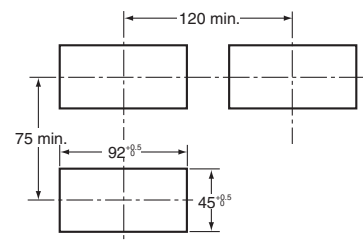

Mounting Recommended Panel Thickness 1 to 8 mm.

Mount the product horizontally.

The K3MA-L uses M3 terminals. A terminal cover is provided.

## Application Examples

### Monitoring the temperature of an industrial furnace

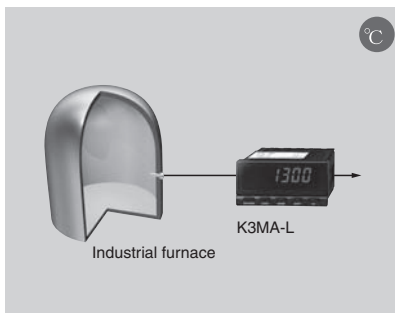

- Monitoring the temperature of an industrial furnace/sintering furnace.
- Monitoring/alarm function for disinfecting equipment.

### Sending a temperature alarm for molding equipment

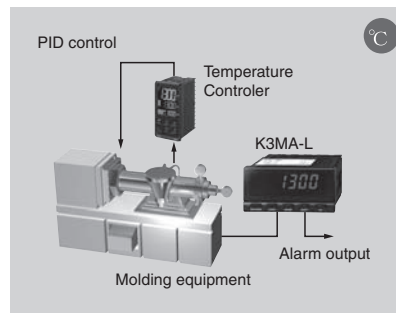

- Monitoring (failsafe checking) abnormal temperatures in molding equipment.
- Monitoring the liquid temperature for cleaning devices.

### Monitoring the bearing temperature for a generator motor

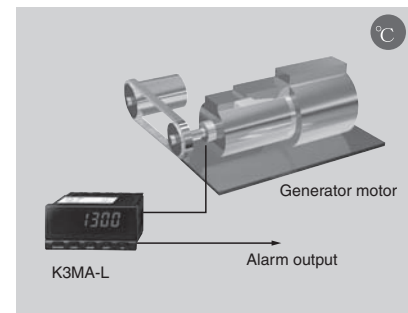

- Monitoring temperature rises in electric power generating facilities.
- Inspecting temperatures in machines and devices.



# Installation

1. Insert the K3MA-L into the panel cut-out hole.
2. For a waterproof installation, insert the rubber gasket onto the body of the K3MA-L.

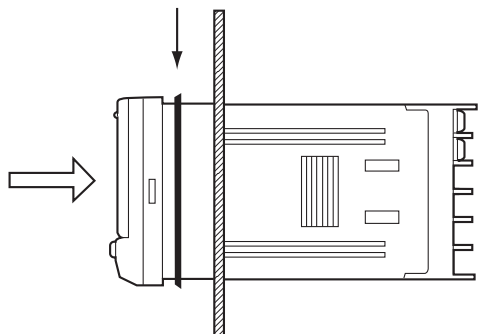

3. Fit the adaptor into the grooves on the left and right sides of the rear case, then push it until it contacts the panel to secure the K3MA-L.

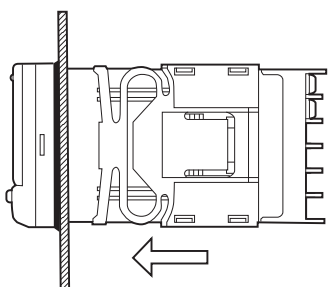

## ■ LCD Angle of View

The K3MA is designed to provide the best visibility at the angles shown in the following diagram.

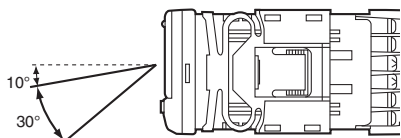

## ■ Watertight Cover

Y92A-49N

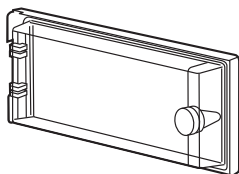

## ■ Rubber Packing

K32-P1

If the rubber packing is lost or damaged, it can be ordered using the following model number: K32-P1.

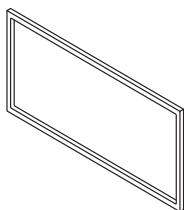

(Depending on the operating environment, deterioration, contraction, or hardening of the rubber packing may occur and so, in order to ensure the level of waterproofing specified in NEMA4, periodic replacement is recommended.)

**Note:** Rubber packing is provided with the Controller.

## ■ Wiring Precautions

- Use crimp terminals.
- Tighten the terminal screws to a torque of approximately 0.5 N·m.
- To avoid the influence of noise, route signal lines and power lines separately.

## ■ Wiring

- Use the following M3 crimp terminals.

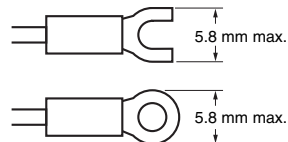

## ■ Unit Labels (Provided)

- The unit labels are not attached to the K3MA-L. Select the desired labels from the provided sheet.

V	A	V	A	%	J	Pa	Ω
s	/	N	m	W	°C	m <sup>3</sup>	k
°F	g	min	mm	rpm			
VA	mV	mA	Hz				
m/min	OMRON						
OUT	OUT						

**Note:** For scales and gauges, use the unit labels that are specified by the relevant laws or regulations.

# Operating Procedures

## ■ Operations in Run Mode

### Checking the Maximum and Minimum Values

The maximum and minimum values can be displayed by pressing the MAX/MIN Key while the measurement is being displayed.

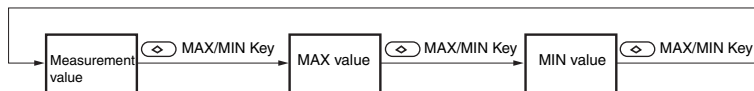

The maximum and minimum values can be reset by pressing the MAX/MIN Key for 1 s min. when the maximum or minimum value is displayed.

### Checking and Setting Comparative Set Values (for Models with the Comparative Output Function)

Each time the Mode Key is pressed when the measurement value, maximum value, or minimum value is displayed, the comparative values will be displayed in the following order: OUT1 value (or OUT1 upper-limit value, OUT1 lower-limit value).

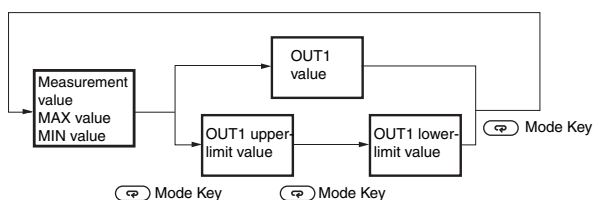

## ■ Adjustment Level Operation

### Setting Temperature Input Shift Values

#### Temperature Input Shift

A shift value can be set for a temperature input.

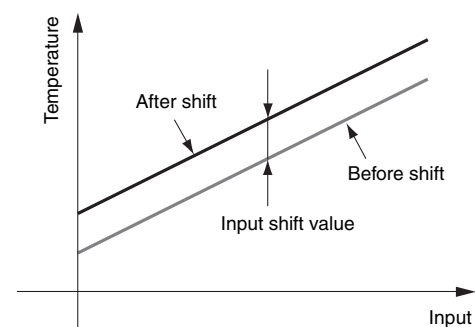

The value set for the temperature input shift is applied to the entire measurement range of the temperature sensor.

## ■ Levels

“Level” refers to a grouping of parameters. The following table lists the operations that are possible in each of the levels, and the diagram tells how to move between levels. There are some parameters that are not displayed for certain models.

Level name	Function	Measurement
Protect	Setting lockouts.	Continue
Operation	Displaying current values, and setting OUT 1 value.	Continue
Adjustment	Setting communications writing control.	Continue
Initial setting	Making initial settings of input type, output operating action, and other parameters.	Stopped
Advanced-function setting	Setting average processing, display color settings, and other advanced function parameters.	Stopped

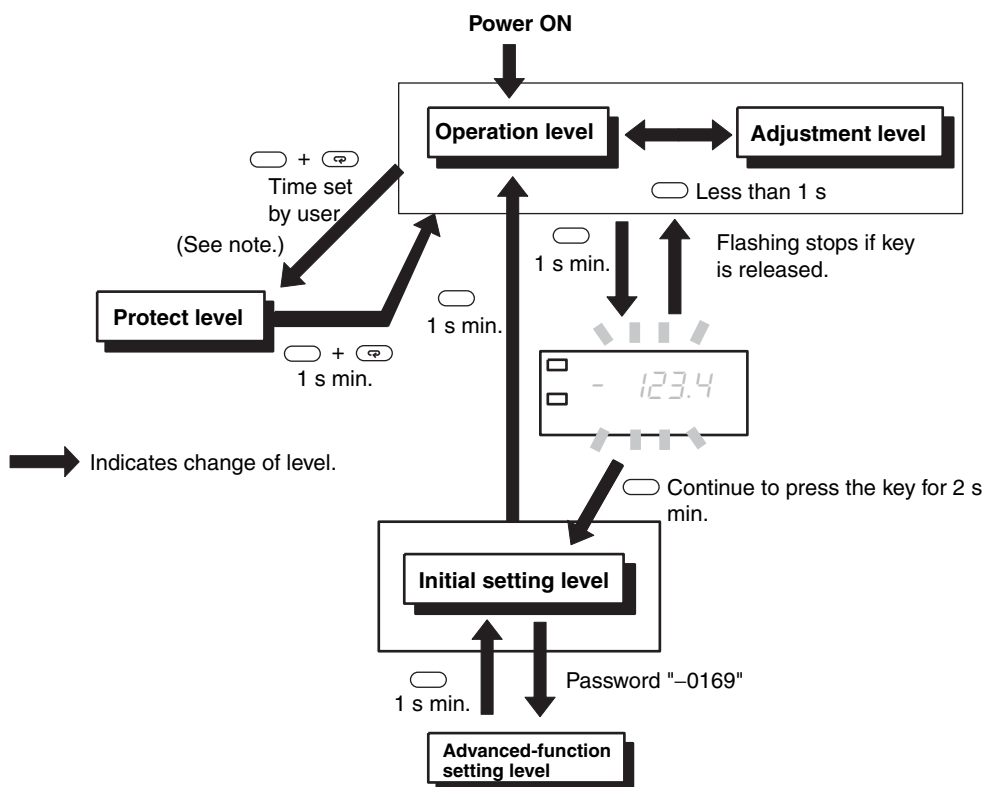

**Note:** The move-to-protect-level time can be set in the advanced-function setting level.

## Parameters

- Note:**
1. Some parameters are not displayed for certain models.
  2. The K3MA-L will stop measurement if the level is changed to the initial setting level or the advanced-function setting level.
  3. If the input range is changed, some parameters are set to default values. Therefore, set the input range first.
  4. Settings displayed in reversed colors are defaults.

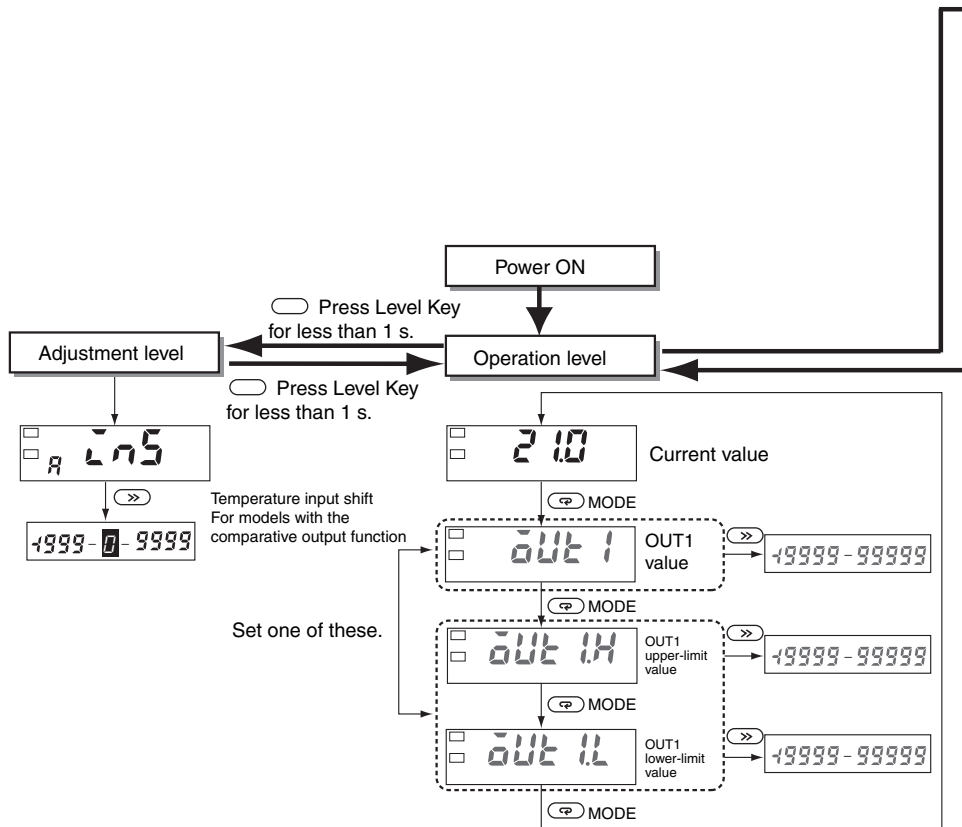

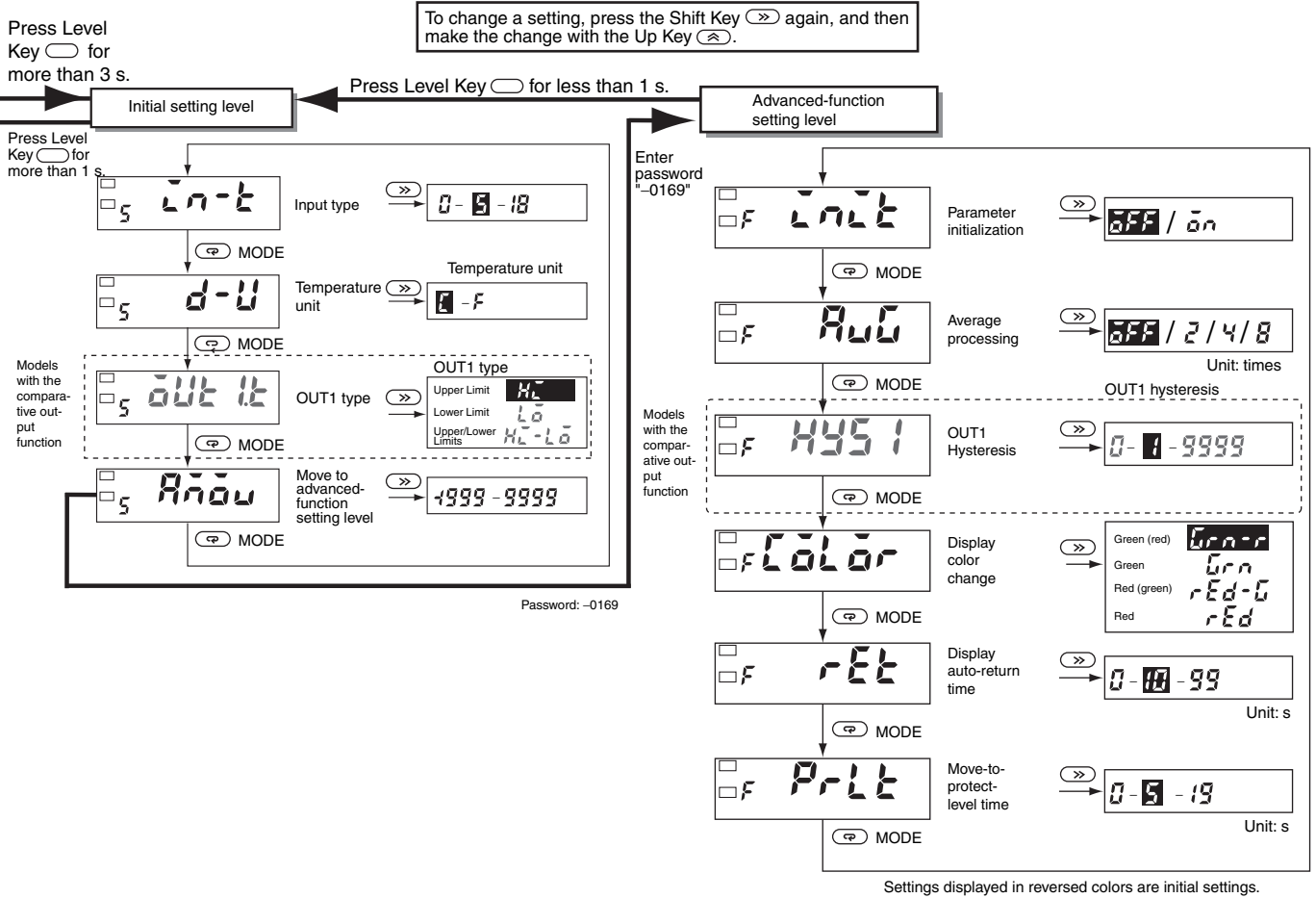

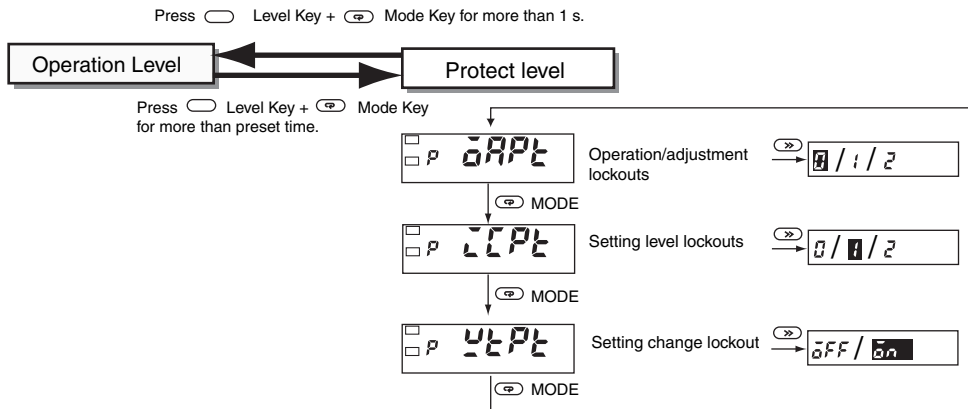

### Operation/Adjustment Lockouts

Restricts key operations for operation level and adjustment level.

Parameter	Setting	Operation level		Moving to adjustment level
		Process value display	Set value display	
0APL	0	Allowed	Allowed	Allowed
	1	Allowed	Allowed	Prohibited
	2	Allowed	Prohibited	Prohibited

- Initial setting is 0.
- This cannot be displayed on models not equipped with the comparative output function.

### Setting Level Lockouts

Restricts shifting to initial setting level or advanced-function setting level.

Parameter	Setting	Shift to initial setting level	Shift to advanced-function setting level
LCP	0	Allowed	Allowed
	1	Allowed	Prohibited
	2	Prohibited	Prohibited

### Setting Change Lockout

Restricts setting changes by key operation. When this lockout is set, it is no longer possible to shift to a setting change mode.

Parameter	Setting	Setting change by key operation
LCP	0FF	Allowed
	0n	Prohibited

However, all protect level parameters can still be changed.

### Initial Settings

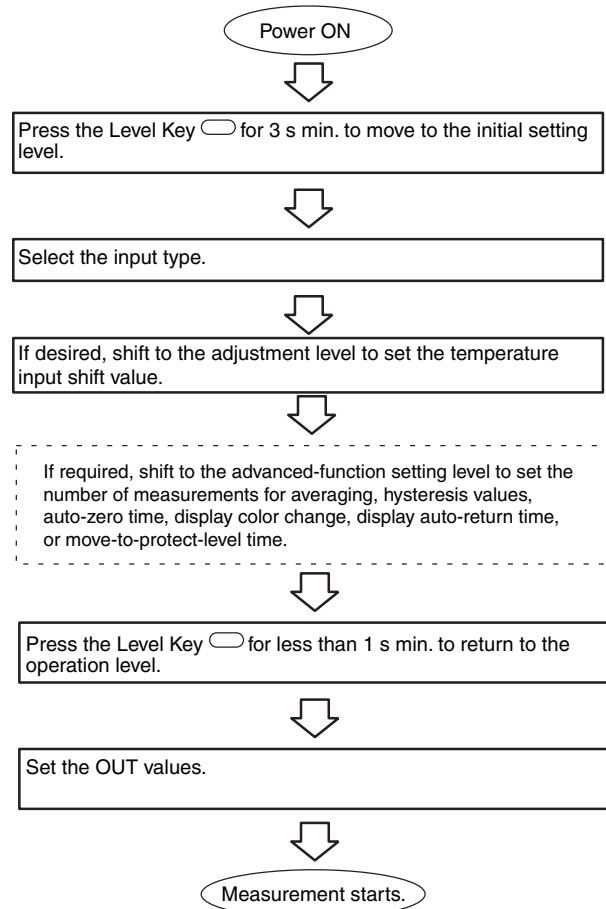

## ■ Setting Example

### Initial Settings

The settings for the following example are shown here.

### Example: Monitoring the temperature of an industrial furnace

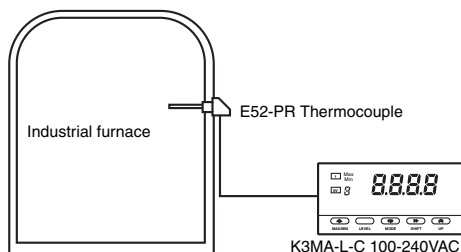

Here, the temperature inside the furnace is to be displayed in centigrade (°C).

Temperature sensor: E52-PR Thermocouple, Measurement range: 0 to 1,400°C.

1. Set the K3MA-L input type to the thermocouple R input range.  
Parameter:  $\bar{L}n-t$  (input type), Setting value:  $15$
2. Select centigrade (°C) as the temperature unit.  
Parameter:  $d-U$  (temperature unit), Setting value:  $1$

If you are using a comparative output model, make the setting as desired.

## ■ Troubleshooting

When an error occurs, error details will be displayed on the main indicator. Confirm the error from the main indicator and take the appropriate countermeasures.

Level display	Main indicator	Error contents	Countermeasures
Not lit	$E111$	RAM memory error	Repair is necessary. Consult your OMRON sales representative.
5	$E111$	EEPROM memory error	When this error is displayed, press the Level Key for 3 seconds, and the settings will be restored to the factory settings. If the error cannot be recovered, repair is necessary. Consult your OMRON sales representative.
Not lit	Flashes $5.Err$	Input error	Confirm that the temperature sensor is correctly connected, and that there are no broken signal lines to the temperature sensor. Input value is out of the specified range (control range). Set the value within the range immediately. If the condition does not return to normal, repair is necessary. Consult your OMRON sales representative.
Not lit	Flashes $9999$	The measurement value after temperature input correction exceeds 9999.	The temperature input correction value may be inappropriate. Use the adjustment level to review the temperature input correction value.
Not lit	Flashes $-1999$	The measurement value after temperature input correction is lower than -1999.	The temperature input correction value may be inappropriate. Use the adjustment level to review the temperature input correction value.

ALL DIMENSIONS SHOWN ARE IN MILLIMETERS.

To convert millimeters into inches, multiply by 0.03937. To convert grams into ounces, multiply by 0.03527.

In the interest of product improvement, specifications are subject to change without notice.

## Terms and Conditions Agreement

### Read and understand this catalog.

Please read and understand this catalog before purchasing the products. Please consult your OMRON representative if you have any questions or comments.

### Warranties.

(a) Exclusive Warranty. Omron's exclusive warranty is that the Products will be free from defects in materials and workmanship for a period of twelve months from the date of sale by Omron (or such other period expressed in writing by Omron). Omron disclaims all other warranties, express or implied.

(b) Limitations. OMRON MAKES NO WARRANTY OR REPRESENTATION, EXPRESS OR IMPLIED, ABOUT NON-INFRINGEMENT, MERCHANTABILITY OR FITNESS FOR A PARTICULAR PURPOSE OF THE PRODUCTS. BUYER ACKNOWLEDGES THAT IT ALONE HAS DETERMINED THAT THE PRODUCTS WILL SUITABLY MEET THE REQUIREMENTS OF THEIR INTENDED USE.

Omron further disclaims all warranties and responsibility of any type for claims or expenses based on infringement by the Products or otherwise of any intellectual property right. (c) Buyer Remedy. Omron's sole obligation hereunder shall be, at Omron's election, to (i) replace (in the form originally shipped with Buyer responsible for labor charges for removal or replacement thereof) the non-complying Product, (ii) repair the non-complying Product, or (iii) repay or credit Buyer an amount equal to the purchase price of the non-complying Product; provided that in no event shall Omron be responsible for warranty, repair, indemnity or any other claims or expenses regarding the Products unless Omron's analysis confirms that the Products were properly handled, stored, installed and maintained and not subject to contamination, abuse, misuse or inappropriate modification. Return of any Products by Buyer must be approved in writing by Omron before shipment. Omron Companies shall not be liable for the suitability or unsuitability or the results from the use of Products in combination with any electrical or electronic components, circuits, system assemblies or any other materials or substances or environments. Any advice, recommendations or information given orally or in writing, are not to be construed as an amendment or addition to the above warranty.

See <http://www.omron.com/global/> or contact your Omron representative for published information.

### Limitation on Liability; Etc.

OMRON COMPANIES SHALL NOT BE LIABLE FOR SPECIAL, INDIRECT, INCIDENTAL, OR CONSEQUENTIAL DAMAGES, LOSS OF PROFITS OR PRODUCTION OR COMMERCIAL LOSS IN ANY WAY CONNECTED WITH THE PRODUCTS, WHETHER SUCH CLAIM IS BASED IN CONTRACT, WARRANTY, NEGLIGENCE OR STRICT LIABILITY.

Further, in no event shall liability of Omron Companies exceed the individual price of the Product on which liability is asserted.

### Suitability of Use.

Omron Companies shall not be responsible for conformity with any standards, codes or regulations which apply to the combination of the Product in the Buyer's application or use of the Product. At Buyer's request, Omron will provide applicable third party certification documents identifying ratings and limitations of use which apply to the Product. This information by itself is not sufficient for a complete determination of the suitability of the Product in combination with the end product, machine, system, or other application or use. Buyer shall be solely responsible for determining appropriateness of the particular Product with respect to Buyer's application, product or system. Buyer shall take application responsibility in all cases.

NEVER USE THE PRODUCT FOR AN APPLICATION INVOLVING SERIOUS RISK TO LIFE OR PROPERTY OR IN LARGE QUANTITIES WITHOUT ENSURING THAT THE SYSTEM AS A WHOLE HAS BEEN DESIGNED TO ADDRESS THE RISKS, AND THAT THE OMRON PRODUCT(S) IS PROPERLY RATED AND INSTALLED FOR THE INTENDED USE WITHIN THE OVERALL EQUIPMENT OR SYSTEM.

### Programmable Products.

Omron Companies shall not be responsible for the user's programming of a programmable Product, or any consequence thereof.

### Performance Data.

Data presented in Omron Company websites, catalogs and other materials is provided as a guide for the user in determining suitability and does not constitute a warranty. It may represent the result of Omron's test conditions, and the user must correlate it to actual application requirements. Actual performance is subject to the Omron's Warranty and Limitations of Liability.

### Change in Specifications.

Product specifications and accessories may be changed at any time based on improvements and other reasons. It is our practice to change part numbers when published ratings or features are changed, or when significant construction changes are made. However, some specifications of the Product may be changed without any notice. When in doubt, special part numbers may be assigned to fix or establish key specifications for your application. Please consult with your Omron's representative at any time to confirm actual specifications of purchased Product.

### Errors and Omissions.

Information presented by Omron Companies has been checked and is believed to be accurate; however, no responsibility is assumed for clerical, typographical or proofreading errors or omissions.

2017.4

In the interest of product improvement, specifications are subject to change without notice.

**OMRON Corporation**  
Industrial Automation Company

<http://www.ia.omron.com/>

(c)Copyright OMRON Corporation 2017 All Right Reserved.



## X-ON Electronics

Largest Supplier of Electrical and Electronic Components

*Click to view similar products for [omron](#) manufacturer:*

Other Similar products are found below :

[G9ED-1-B-AQ-DC24](#) [E3X-SD11 2M](#) [S8VM-10024C](#) [R88A-CCW002P2](#) [S82Y-VM30D](#) [H3AM-NS-A AC100-240](#) [G3NA-440B-2 DC5-24](#)  
[XF2J-0824-11A-R100](#) [G3NA-425B-2 DC5-24](#) [XF2J-0824-12A](#) [G8JN-1C7T-R-DC12](#) [G8VA-1A4T-R01-DC12](#) [G8HE-1A7T-R-DC12](#)  
[XF2W-2415-1A](#) [XF2U-3015-3A](#) [G8V-RH-1A7T-R-DC12](#) [LY1D-2-5S-AC120](#) [M165-JR-24D](#) [M16-TG-24D](#) [CS1G-CPU43-E](#) [M22CAT1](#)  
[61F-GP-NT AC110](#) [M7E-01DGN2-B](#) [M7E-02DGN2](#) [M7E-08DRN2](#) [M7E-20DRN1](#) [M7E-HRN2](#) [M8PHWS](#) [D2HW-C233MR](#) [F03-02](#)  
[SUS316](#) [F150LTC20](#) [F3SJ-A0245P30](#) [F3STGRNSMC21M1J8](#) [F3UVHM](#) [MG2-US-AC24](#) [MK2EP-UA-AC6V](#) [MK2PNIAC240](#) [MK310E-](#)  
[DC24](#) [MKS2XTIN-11 DC110](#) [MM4KPAC120NC](#) [MM4XPAC120](#) [G2Q-184P-V-DC5](#) [G2R-1114P-V-US-DC5](#) [G2R13SNDDC24](#) [G2RL-](#)  
[2A4-CF-DC48](#) [G2U-114P-US-DC12](#) [G2V-234P-US-DC48](#) [G3CA-8H-AC100/110/120](#) [G3PA-210B-US-DC24](#) [G3PE525B3NDC1224](#)