

## AGASTAT 2100 Series, Miniature Electropneumatic Timing Relay



### Product Facts

- **High Repeat Accuracy over voltage and temperature extremes**
- **Hermetically sealed units are designed for high shock and vibration applications**
- **Instant recycling — easy linear adjustment**
- **Exclusive Dial Head adjustment — no needle valves**
- **Delay ranges from milliseconds to 3 minutes**
- **DPDT contacts**

### Design & Construction

**Sealed patented timing head** — circulates air under controlled pressure through a variable orifice to provide adjustable timing. Circular-path Dial Head principle replaces traditional needle valve.

**Snap-action switch assembly** — provides sustained contact pressure during timing cycles. Specially designed over center mechanism assures flutter-free load transfer after extended delay periods.

**Precision-wound solenoid assembly** — supplies the basic motive force when the control circuit is closed. These assemblies are mounted in a rigid self-supporting framework within a steel enclosure. This rugged construction assures permanent alignment of all operating members, the key to this unit's long trouble-free operation.

Users should thoroughly review the technical data before selecting a product part number. It is recommended that users also seek out the pertinent approvals files of the agencies/laboratories and review them to ensure the product meets the requirements for a given application.



### Operation

#### Series 2112 (On-Delay)

Applying rated voltage to the solenoid coil starts the preset time delay. At the end of the delay period the NC contacts break and the NO contacts make. Contacts remain in this position until the coil is de-energized, when the switch instantaneously returns to its original position. De-energizing the coil, either during or after the delay period, will immediately (within 25 msec.) recycle the unit. It will then provide another full delay period on re-energization.

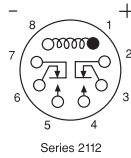

#### Series 2122 (Off-Delay)

Applying rated voltage to the coil for at least 75 msec. (for accurate timing) will instantaneously transfer the switch, breaking the NC contacts and making the NO contacts. Contacts remain in this position as long as the coil is energized. The preset time delay period begins as soon as the coil is de-energized, at the end of which the switch returns to its original position. **No power is required during the timing period.** Re-energizing the coil, either during or after the delay period, will immediately start a new cycle with full delay period.

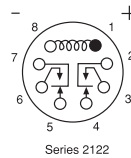

**Operation** (Listed values at nominal voltage, 25°C unless noted)

#### Operating Mode

**2112** — On-delay (delay on pull-in); **2122** — Off-delay (delay on drop-out)

**Timing Adjustment** — All standard models offer easy linear adjustment over one of nine timing ranges listed below. For applications requiring frequent readjustment, the external knob model is recommended. For tamper-proof installation or where readjustment is infrequent, the internal key model may be preferred. This model requires removal of the cover plate for timing adjustment. Hermetically sealed models provide a slotted adjusting screw under the cap nut on the top cover.

#### Timing Ranges

Code	Range
A	.03 to .1 sec.
B	.1 to .3 sec.
C	.15 to 1.0 sec.
D	.375 to 3.0 sec.
E	.75 to 10.0 sec.
F	1.0 to 30.0 sec.
G	2.0 to 60.0 sec.
H	5.0 to 120.0 sec.
J	5.0 to 180.0 sec.
K	1.5 to 30.0 cycles
L	3.0 to 120.0 cycles

#### Repeat Accuracy — NORMAL VERTICAL POSITION

±5% at 25°C; ±7% at 85°C; ±8% at -55°C. The average time between -55°C and 85°C will be within ±20% of the average @ 25°C with a proportionally reduced effect at lesser extremes.

In extremely short delay settings an additional 8 msec. variation may result on AC models due to "half cycle" alternating current effect.

**Setting Tolerance** — Factory time setting, when specified, subject to additional +5% tolerance.

#### Position Sensitivity

**HORIZONTAL POSITION** — Approximately 5% increase from the initial time in the vertical position.

**INVERTED POSITION** — Approximately 10% increase from the initial time in the vertical position.

**Reset Time** — 2112 Series: 25 msec.; 2122 Series: 75 msec.

**Relay Release Time** — 25 msec. (2112 Series)

**Relay Operate Time** — 75 msec. (2122 Series)

#### Operating Voltage — Coil Data

Code	Nominal Operating Voltage	Resistance Ohms ±10%
M	12VDC	30
N	28VDC	131
P	48VDC	500
R	110VDC	3200
S	120V 60 Hz	190 (2112 Series)
S	120V 60Hz	285 (2122 Series)
T	240V 60Hz	765
U	115V 400Hz	2600
Y	125VDC	3380

**Transients** — Insensitive to transients of ±1500 VAC for 10 milliseconds

**Dielectric** — 1000V RMS @ 60Hz between non-connected terminals.

#### Contact Rating (DPDT Contacts)

	30V DC	110V DC	120V 60Hz	120V 400Hz	240V 60Hz
<b>Inductive (Amps)</b>	2	.75	3	2	1.5
<b>Resistive (Amps)</b>	10	1	10	10	5

Based on 100,000 operations electrical, 1,000,000 mechanical. Inductive and capacitive load should not have inrush currents that exceed five times normal operating load.

**Ambient Temperature Range** — -55°C to +85°C

**Weight** — Maximum, any unit - 17 ozs.

**Mounting/Terminals** — Chassis mounting tabs, octal plugs and external (-4) or internal (-5) adjustment. Panel mounting back plate, internal adjustment, and solder hook terminals (-9).



**These are minimum standards; where more severe environmental conditions must be met, please consult the factory.**

**AGASTAT 2100 Series, Miniature Electropneumatic Timing Relay** (Continued)

Outline Dimensions for Industrial Models (Dimensions in inches. Multiply by 25.4 to obtain millimeters.)

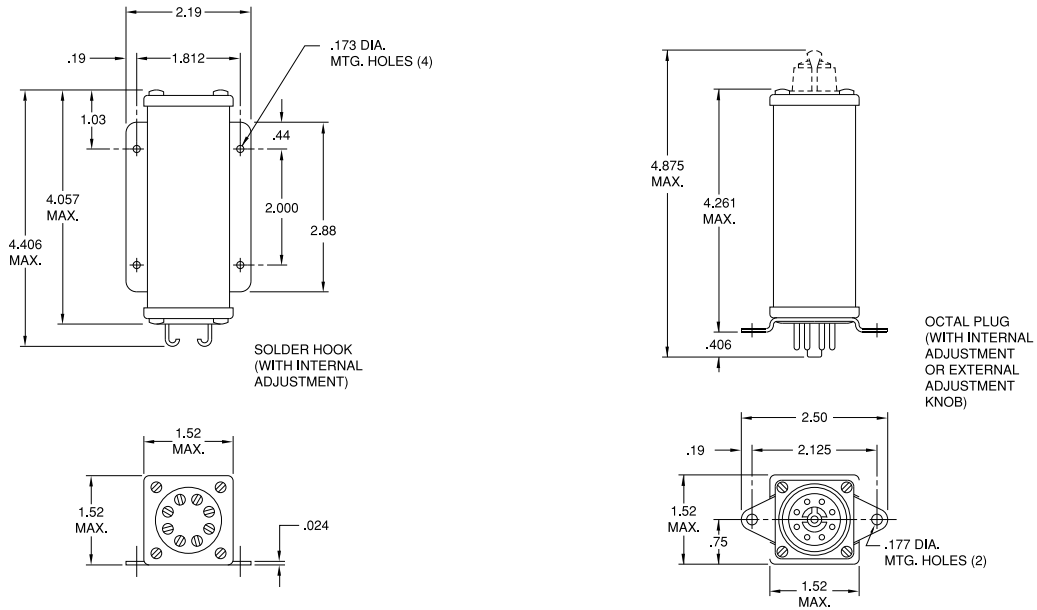

**Ordering Information for Industrial Models**

Typical Part No. ▶					<b>21</b>	<b>1</b>	<b>2</b>	<b>D</b>	<b>4</b>	<b>N</b>	<b>B</b>			
<b>1. Basic Series:</b> 21 = 2100 Miniature electropneumatic timing relay														
<b>2. Operation:</b> 1 = On-delay                      2 = Off-delay														
<b>3. Contact Arrangement:</b> 2 = DPDT (2 form C)														
<b>4. Operating Voltage:</b> A = AC                              D = DC														
<b>5. Physical Characteristics:</b>														
Code	Enclosure	Adjustment	Connector	Mounting										
4 =	Unsealed	External Knob	Octal Plug	Chassis Mount										
5 =	Unsealed	Internal Key	Octal Plug	Chassis Mount										
9 =	Unsealed	Internal Key	Solder Hook	Panel Mount Plate										
<b>6. Coil Voltage:</b>														
M = 12VDC			N = 28VDC			P = 48VDC			R = 110VDC			Y = 125VDC		
S = 120VAC, 50/60 Hz.			T = 240VAC, 60 Hz.											
<b>7. Timing Range:</b>														
A = .03 to .1 sec.		C = .15 to 1.0 sec.		E = .75 to 10.0 sec.		H = 5.0 to 120.0 sec.		K = 1.5 to 30.0 cycles						
B = .1 to .3 sec.		D = .375 to 3.0 sec.		F = 1.0 to 30.0 sec.		J = 5.0 to 180.0 sec.		L = 3.0 to 120.0 cycles						

Our authorized distributors are more likely to maintain the following items in stock for immediate delivery.

None at present.

12  
Specialty Relays

**AGASTAT 2100 Series, Miniature Electropneumatic Timing Relay (Continued)**

**Specifications for Hermetically Sealed Models**



**Dielectric** — Withstands 1,000 Volts RMS at 60 Hz between non-connected terminals.

**Other** — AGASTAT Miniature Timing Relays also conform to applicable requirements covering:

- |            |                   |
|------------|-------------------|
| Moisture   | Ozone             |
| Humidity   | Sunshine          |
| Sand/Dust  | Acoustic Noise    |
| Salt Spray | Prolonged Storage |

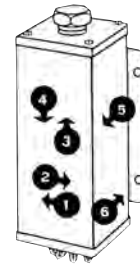

**Outline Dimensions for Hermetically Sealed Models (In inches. Multiply by 25.4 for millimeters.)**

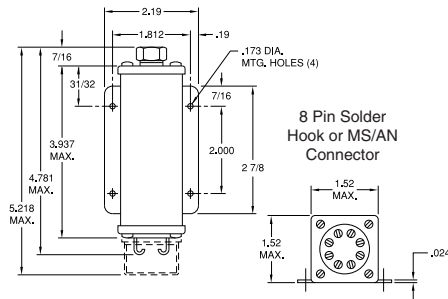

**Panel Mount  
-H1, -H3**

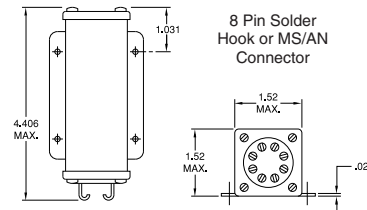

**Panel Mount  
-9**

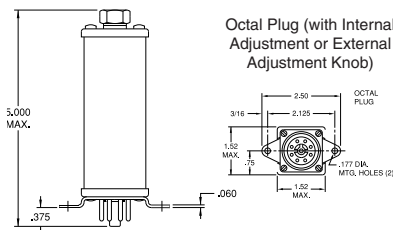

**Chassis Mount  
-H2**

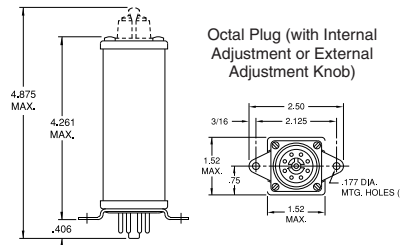

**Chassis Mount  
-4, -5**

**AGASTAT 2100 Series, Miniature Electropneumatic Timing Relay** (Continued)

**Ordering Information for Hermetically Sealed & Unsealed Models**

Typical Part No. ►					21	1	2	D	H1	N	B
<b>1. Basic Series:</b> 21 = 2100 Miniature electropneumatic timing relay											
<b>2. Operation:</b> 1 = On-delay                      2 = Off-delay											
<b>3. Contact Arrangement:</b> 2 = DPDT (2 form C)											
<b>4. Operating Voltage:</b> A = AC                              D = DC											
<b>5. Physical Characteristics:</b>											
Code	Enclosure	Adjustment	Connector	Mounting							
H1 =	Hermetically Sealed	External Screw	Solder Hook	Panel Mount Plate							
H2 =	Hermetically Sealed	External Screw	Octal Plug	Chassis Mount							
H3 =	Hermetically Sealed	External Screw	"AN" Connector	Panel Mount Plate							
4 =	Unsealed	External Knob	Octal Plug	Chassis Mount							
5 =	Unsealed	Internal Key	Octal Plug	Chassis Mount							
9 =	Unsealed	Internal Key	Solder Hook	Panel Mount Plate							
<b>6. Coil Voltage:</b>											
M = 12VDC	N = 28VDC	P = 48VDC	R = 110VDC	Y = 125VDC							
S = 120VAC, 50/60 Hz.	T = 240VAC, 60 Hz.	U = 115VAC, 400 Hz.									
<b>7. Timing Range:</b>											
A = .03 to .1 sec.	C = .15 to 1.0 sec.	E = .75 to 10.0 sec.	H = 5.0 to 120.0 sec.	K = 1.5 to 30.0 cycles							
B = .1 to .3 sec.	D = .375 to 3.0 sec.	F = 1.0 to 30.0 sec.	J = 5.0 to 180.0 sec.	L = 3.0 to 120.0 cycles							

Our authorized distributors are more likely to maintain the following items in stock for immediate delivery.

None at present.

## AGASTAT 7000 Series, Industrial Electropneumatic Timing Relay



### Product Facts

- Available in on-delay, true off-delay, and on/off-delay
- Timing from 0.1 seconds to 60 minutes, in linear increments
- Oversize adjustment knobs, serrated with high-resolution markings visible from all angles makes the timer easy to set
- Inherent transient immunity
- Standard voltages from 6-550VAC and 12-550VDC (special voltages available)
- Available in 2-pole or 4-pole models
- Numerous enclosure options — explosion proof, dust tight, watertight, hermetically-sealed, NEMA 1
- Auxiliary timed and instantaneous switches can be added for greater switching flexibility
- Many mounting options — Surface mount, Panel mount, Octal plug-in mounting
- Options: quick-connect terminals, dial stops, and transient protection module
- Easy-to-reach screw terminals, all on the face of the unit, clearly identified
- Modular assembly — timing head, coil assembly and switchblock are all individual modules, with switches field-replaceable
- File E15631, File LR29186



### Design & Construction

There are three main components of Series 7000 Timing Relays:

**Timing Head** circulates air through a variable length to provide linearly adjustable timing. Patented design provides easy adjustment and long service life under severe operating conditions.

#### Precision-Wound Potted Coil

Total sealing without external leads eliminates moisture problems, gives maximum insulation value.

#### Snap-Action Switch Assembly

— custom-designed over-center mechanism provides snap action. Standard switches are DPDT arrangement.

Each of these subassemblies forms self-contained modules assembled at the factory with the other two to afford a wide choice of operating types, coil voltages, and timing ranges.

The squared design with front terminals and rear mounting permits the grouping of Series 7000 units side-by-side in minimum panel space. Auxiliary switches may be added in the base of the unit, without affecting the overall width or depth.

### Operation

Two basic operating types are available.

"On-Delay" models provide a delay period on energization, at the end of which the switch transfers the load from one set of contacts to another. De-energizing the unit during the delay period immediately recycles the unit, readying it for another full delay period on re-energization.

In "Off-Delay" models the switch transfers the load immediately upon energization and the delay period does not begin until the unit is de-energized. At the end of the delay period the switch returns to its original position. Re-energizing the unit during the delay period immediately resets the timing, readying it for another full delay period on de-energization.

No power is required during the timing period, providing a true off delay.

In addition to these basic operating types, "Double-Head" models offer sequential delays on pull-in and drop-out in one unit. With the addition of auxiliary switches the basic models provide two-step timing.

**Note: Seismic & radiation tested E7000 models are available. Consult factory for detailed information.**

### On-delay model 7012 (delay on pickup)

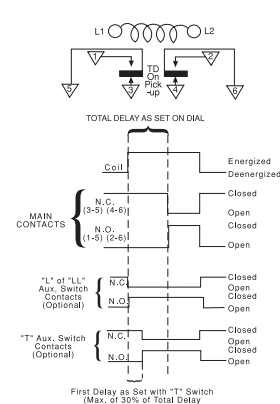

Applying voltage to the coil (L1-L2) for at least 50 msec starts a time delay lasting for the preset time. During this period the normally closed contacts (3-5 and 4-6) remain closed. At the end of the delay period the normally closed contacts break and the normally open contacts (1-5 and 2-6) make. The contacts remain in this transferred position until the coil is deenergized, at which time the switch returns to its original position.

De-energizing the coil, either during or after the delay period, will recycle the unit within 50 msec.

It will then provide a full delay period upon re-energization, regardless of how often the coil voltage is interrupted before the unit has been permitted to "time-out" to its full delay setting.

### Off-delay model 7022 (delay on dropout)

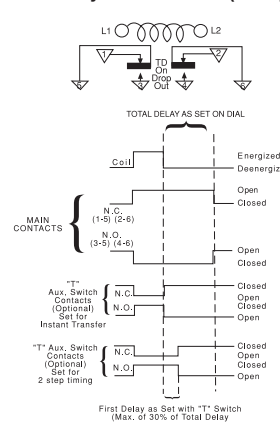

Applying voltage to the coil (for at least 50 msec) will transfer the switch, breaking the normally closed contacts (1-5 and 2-6), and making the normally open contacts (3-5 and 4-6). Contacts remain in this transferred position as long as the coil is energized. The time delay begins immediately upon de-energization. At the end of the delay period the switch returns to its normal position.

Re-energizing the coil during the delay period will immediately return the timing mechanism to a point where it will provide a full delay period upon subsequent de-energization. The switch remains in the transferred position.

**Note:** 7032 types and certain models with accessories are not agency approved. Users should thoroughly review the technical data before selecting a product part number. It is recommended that users also seek out the pertinent approvals files of the agencies/laboratories and review them to ensure the product meets the requirements for a given application.

Consult factory for ordering information.

## X-ON Electronics

Largest Supplier of Electrical and Electronic Components

*Click to view similar products for [Time Delay & Timing Relays](#) category:*

*Click to view products by [TE Connectivity](#) manufacturer:*

Other Similar products are found below :

[7012GD](#) [7012L10BN](#) [7012L10DY1N](#) [7012L10FN](#) [7012L10HN](#) [7012L26K](#) [7012L8AI2LLSN](#) [7012L8BN](#) [7012L8KN](#) [7012OBILM](#)  
[7012OIT](#) [7012PALL](#) [7012PDM](#) [7012PFX](#) [7022L10DN](#) [7022L8BN](#) [7022L8EN](#) [7022L8HN](#) [7022X3D](#) [7024NB](#) [7024SCT](#) [88256455](#) [H3BG-](#)  
[N8H](#) [AC110V](#) [H3CRF8AC2448DC1248](#) [1423151-3](#) [1423154-8](#) [1423462-7](#) [1423618-6](#) [1423151-5](#) [1423156-7](#) [1423618-4](#) [2112AH1SDC947](#)  
[2122DH1NJC467](#) [2122DH1PE](#) [2-1617805-2](#) [2-1617805-6](#) [K61C-08](#) [286XCXC-300-24D](#) [SCBRX022XXACXAC991](#) [SHS10S110A](#)  
[SHS20M220A](#) [1755074-5](#) [SSC12AKA](#) [FAASPRING2](#) [2112DH3NDC50-13](#) [2122DH34NDC629](#) [2-1437479-8](#) [2-1617805-1](#) [2-1617805-3](#) [2-](#)  
[1617805-7](#)