Table of Contents

AMP multifitting Mark II

Introduction	2002
Direct and Indirect Connection 5.0mm Centerline.....	2003
Derating Curves	2004
Keying Plan and Cable Exit	2005
Technical Features	2006
Direct Mating Connector System	2007, 2008
Indirect Mating Connector System.....	2009-2011
PC Board Frame	2012

AMP MONO-SHAPE

Introduction	2013
Connector Versions	2014
Tab Connectors	2015
Tab Connectors Keying Plan	2016
Tab Connector 3-10 Positions	2017-2020
Single Way Connectors	2021
Single Way Connectors Keying Plan	2022
PCB Connectors	2023-2027
Satellite Connectors	2028
Satellite Connectors Keying Plan	2029
Bridge Connectors Keying Plan	2030

AMP MONO-SHAPE Mark II

Introduction	2031
Technical Data	2032
Keying Plan and Cable Exit	2033
Tab Connector System	2034-2035
TAB-BRIDGE Connector System - Short Circuit	2036
PCB Connector System	2037-2041
Application Tooling	2042-2045

Standard Timer

Introduction	2046
Interior and Exterior Locking.....	2047
Keying Plan	2048
Housings	2049-2059
Connectors and Contacts	2060

Introduction

Product Features

- Direct Mating Connectors for PC Boards, 2–8 Positions, up to 6 A Current Carrying Capacity
- Indirect Mating Connectors, 1–8 Positions, up to 16 A Current Carrying Capacity
- Variable Keying
- Double Wire Termination possible

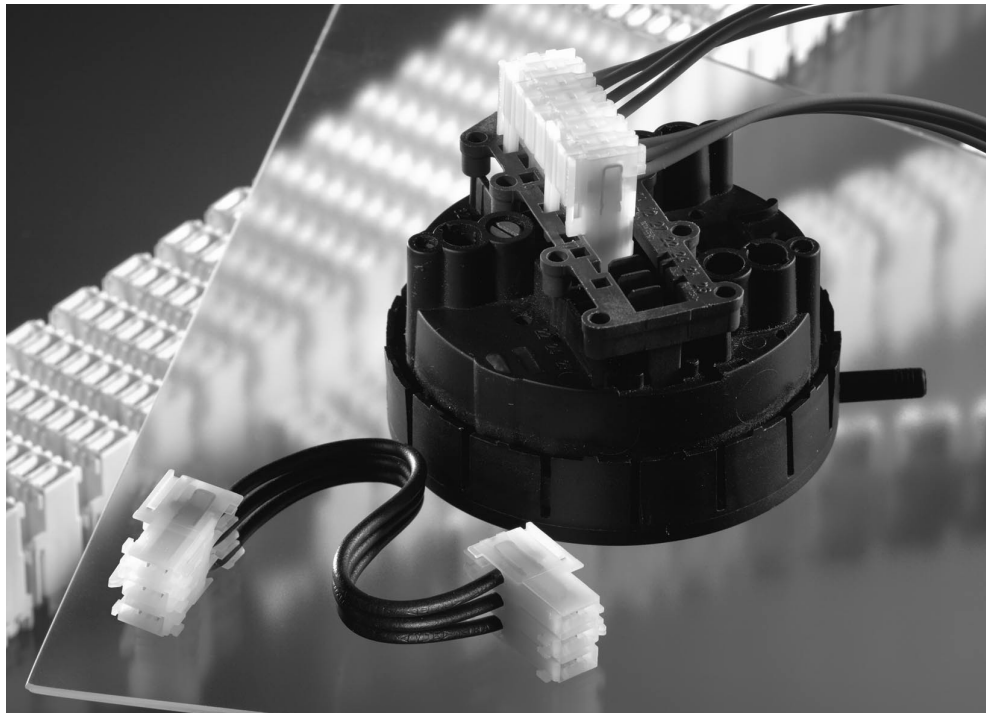

Tyco Electronics' newly designed AMP multifitting Mark II Connector System was developed according to the latest connector design standards.

The requirements of advanced In-Line mating technology for the components and contacts of pc boards are incorporated in the direct and indirect versions of these connector systems.

This system is suitable for a wide wire size range. Current carrying capacity is 16 A maximum.

Double termination is possible with 0.5 and 0.5 mm² or 0.5 and 0.75 mm² conductors.

The connectors are available in 1- to 8-positions (indirect) resp. 2- to 8-positions (direct) with an exterior locking device.

Interior locking options are available on request.

Supplied in chain and provided with all keying and polarisation ribs, the connectors can be operated economically with modern Application Tooling Equipment.

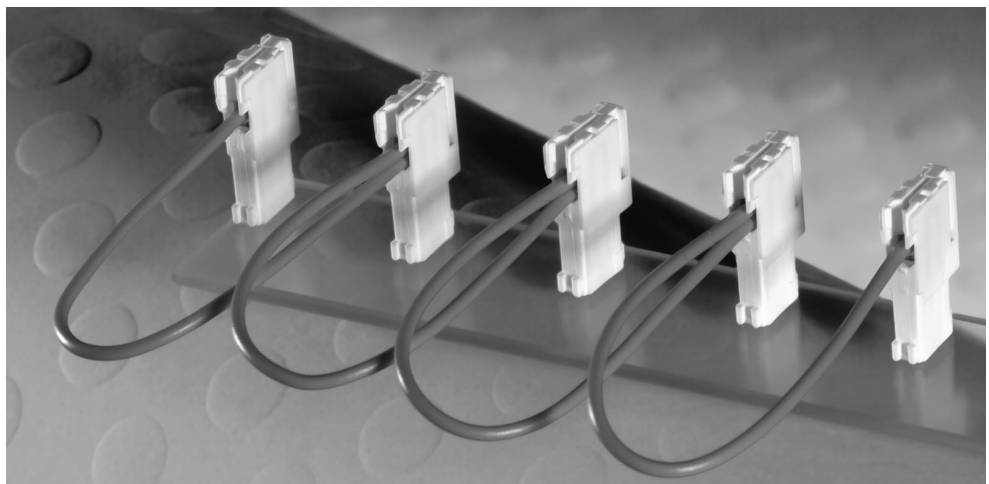

Direct and Indirect Mating Connection, 5.0 mm Centerline

**Direct Mating Connection,
5.0 mm Centerline**

- 1 Double Wire Exit
- 2 Wire Exit 90°
- 3 Wire Exit 180°
- 4 Cover
- 5 Exterior Locking Latch
- 6 Keying
- 7 Polarisation

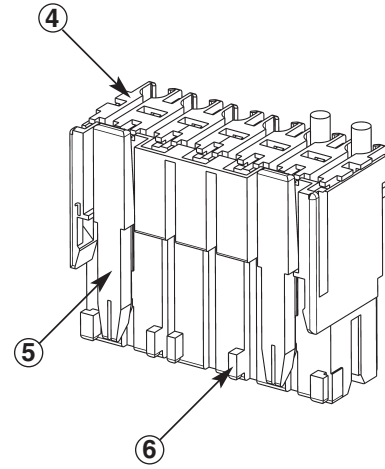
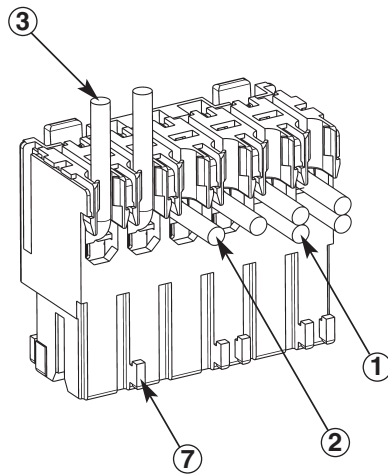

**Indirect Mating Connection,
5.0 mm Centerline**

- 1 Double Wire Exit
- 2 Wire Exit 90°
- 3 Wire Exit 180°
- 4 Cover
- 5 Exterior Locking Latch
- 6 Keying
- 7 Polarisation

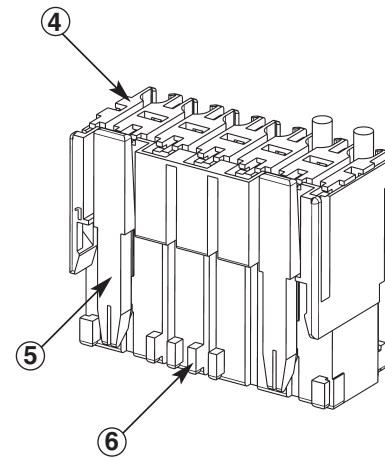
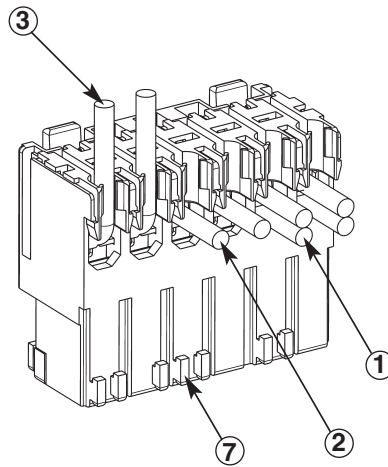

**Indirect Mating Connection
with Interior Locking,
5.0 mm Centerline**

- 1 Double Wire Exit
- 2 Wire Exit 90°
- 3 Wire Exit 180°
- 4 Cover
- 5 Interior Locking Latch
- 6 Keying
- 7 Polarisation

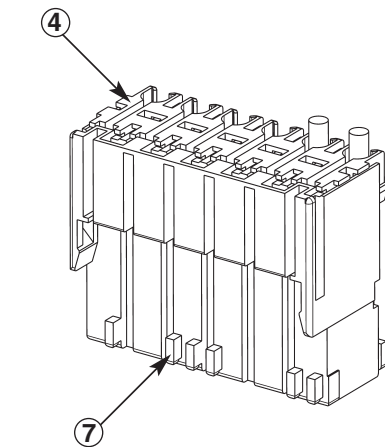
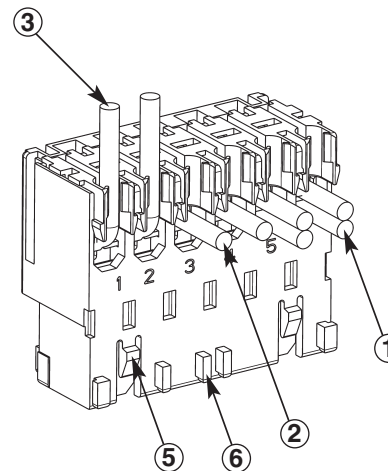

2

Rast 5

Derating Curves

Direct Mating Connector System

Connector:
8 positions

Material:
Brass, tin plated

Wire:
0.5 mm²

PC Board:
FR4, 2 x 0.35 µm Copper,
tin plated

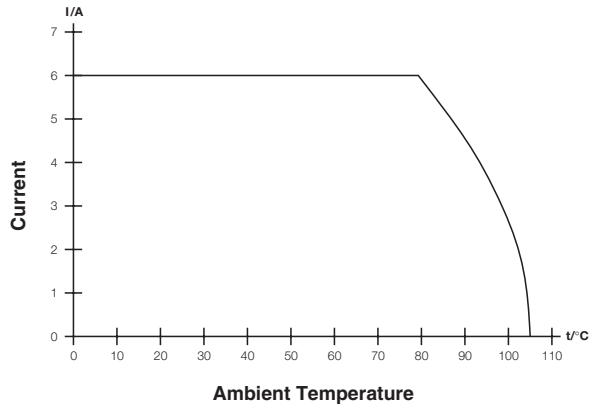

Indirect Mating Connector System

Material:
Brass, tin plated

Wire:
0.5 mm² (Curve 1 and 2)
1.0 mm² (Curve 3)

Mating Part:
6.3 x 0.8 mm Tab,
Brass, tin plated

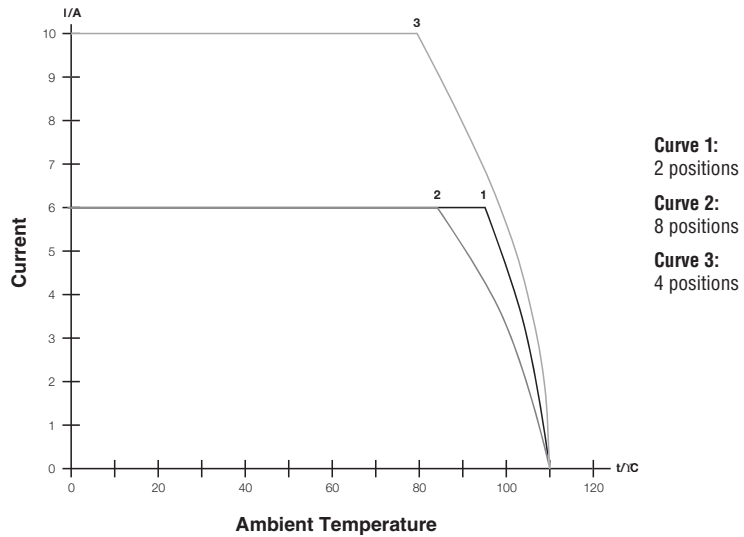

Indirect Mating Connector System

Material:
CuNi2Si, silver plated

Wire:
1.5 mm², tin plated

Mating Part:
6.3 x 0.8 mm Tab,
Brass, tin plated

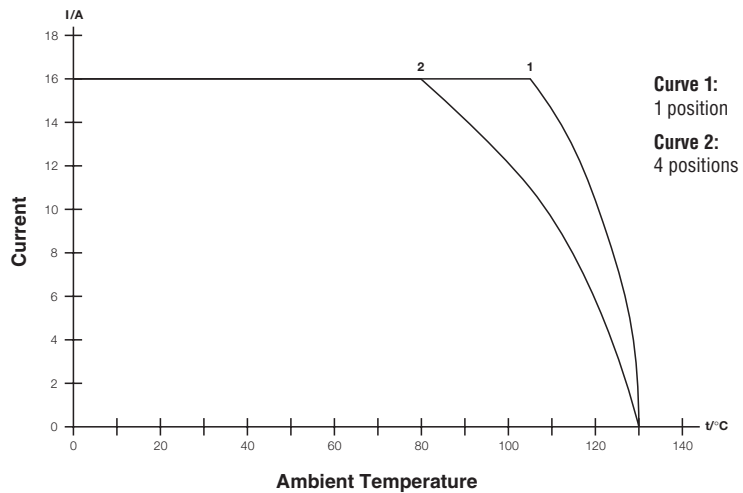

Keying Plan and Cable Exit

Keying Plan from Mating Direction, Fully-Keyed Version

- 1 Locking Latch
- 2 Keying Rib
- 3 Polarisisation Rib
- 4 Cavity Number

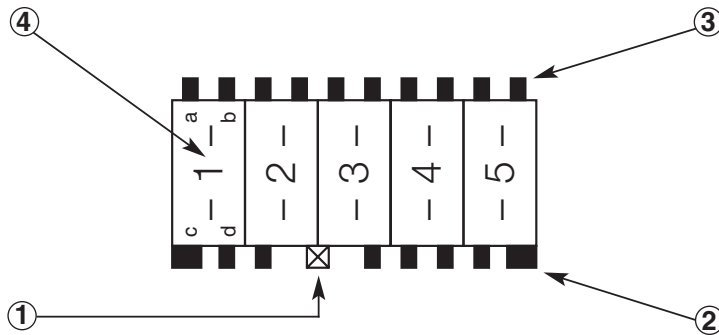

Keyed Version: 05-C according RAST 5

This final keying version will be produced on the Application Tooling Equipment.

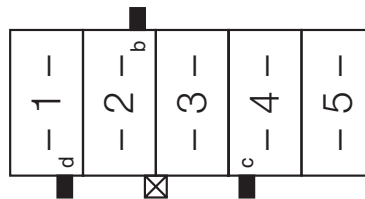

Cable Exit with Interior and Exterior Locking

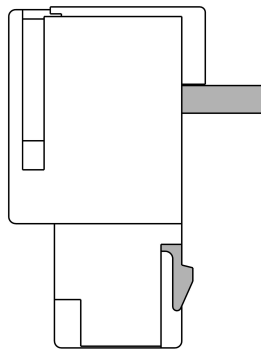

Cable Exit with Interior Locking

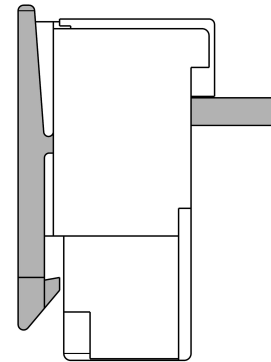

Cable Exit with Exterior Locking

Direct Mating of a PCB with PC Board Frames

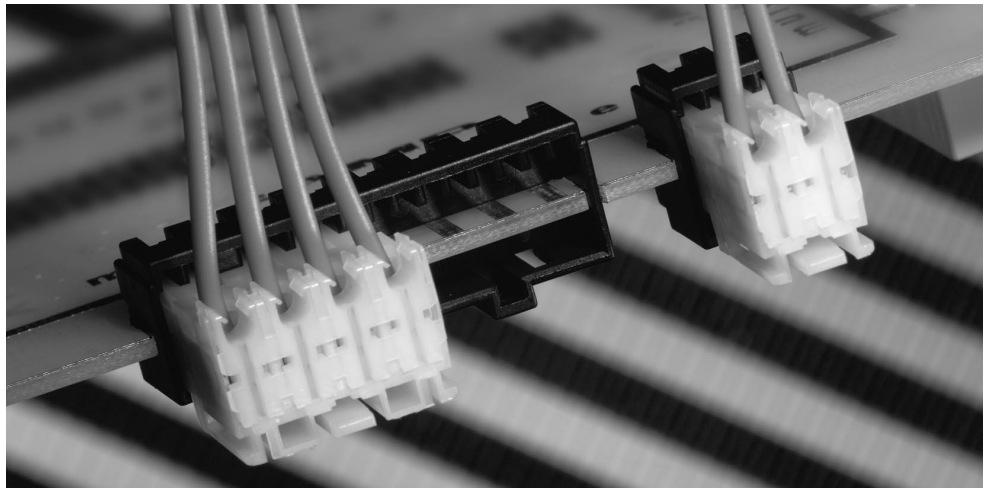

Technical Features

Technical Data

Centerline:
5.0 mm

Housing Material:
Polyamide, PA 6.6 and PA 6

Standard Colour:
Natural

Current Voltage:
250 V ≈

Air and Creepage Distance:
>3.2 mm

Flammability Rating:
UL 94 V-2

Approvals:
VDE, UL

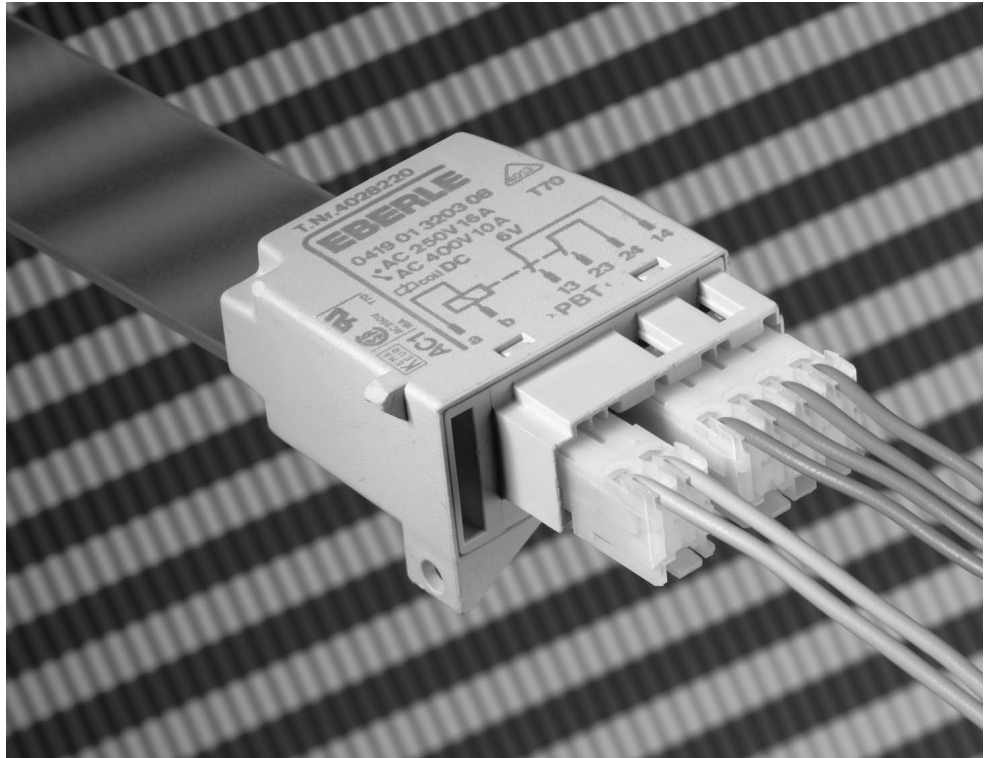

Direct Mating Connectors

No. of Positions:
2- to 8-positions

Contact Material:
Brass

Contact Finish:
Tin plated

Wire Size Range:
0.35–1.0 mm²

Temperature Range:
–40 °C up to +105 °C

Current Rating:
6 A max.

Insulation Diameter:
2.8 mm max.

Insulation Resistance:
>10 MΩ

Mating Force:
≤7 N per contact *

Unmating Force:
≥1.5 N *

Product Specification:
108-18653

Application Specification:
114-18289

*) measured with polished steel
plate 1.5 mm thickness

Indirect Mating Connectors

No. of Positions:
1- to 8-positions

Contact Material:
Brass / CuNi2Si

Contact Finish:
Tin plated / silver plated

Wire Size Range:
0.35–1.0 mm² / 1.0–1.5 mm²

Temperature Range:
–40 °C up to +130 °C

Current Rating:
10 A, up to 4 contacts 16 A

Insulation Diameter:
3.0 mm max.

Insulation Resistance:
>10 MΩ

Mating Force:
≤6.5 N per contact **

Unmating Force:
≥1.5 N **

Product Specification:
108-18652

Application Specification:
114-18288, 114-18382

**) measured with polished steel
tab 6.3 x 0.8 mm

Direct Mating Connector System

Technical Data

Wire Size Range:
0.35–1.0 mm²

Current Carrying Capacity (max.):
6 A

RAST 5 Version	Part Numbers with Exterior Locking		Package Quantity	Part Numbers with Interior Locking	
	PA 6.6	PA 6*		PA 6.6	PA 6*
	1241172-2	1534075-2	4,900	-	-
	1241172-3	1534075-3	3,136	-	-
	1-1241172-3	1-1534075-3	3,136	-	-
	1241172-4	1534075-4	2,352	-	-
	1-1241172-4	1-1534075-4	2,352	-	-
	1241172-5	1534075-5	1,960	-	-
	1-1241172-5	1-1534075-5	1,960	-	-

*)According to IEC 60695-2-1/1; GWT (Glow Wire Test) 750 °C without flame, see VDE M-Test Report.
The final keying version will be produced on the Application Tooling Equipment.

Direct Mating Connector System (continued)

Technical Data

Wire Size Range:
0.35–1.0 mm²

Current Carrying Capacity (max.):
6 A

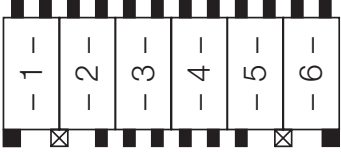
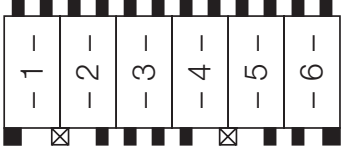
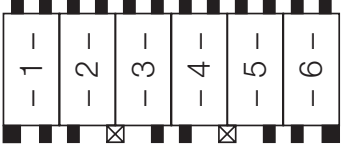
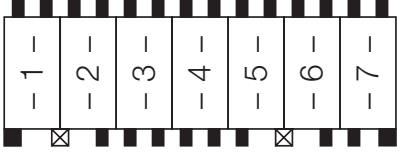
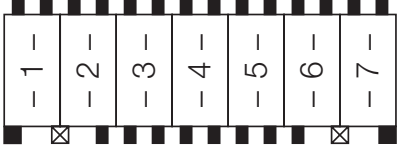
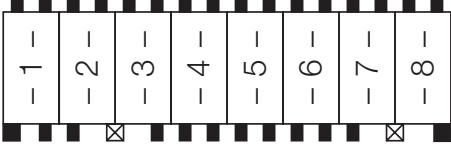
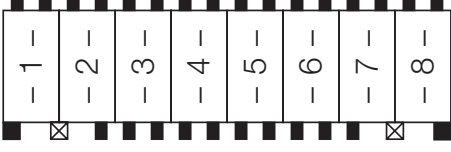
RAST 5 Version	Part Numbers with Exterior Locking		Package Quantity	Part Numbers with Interior Locking	
	PA 6.6	PA 6*		PA 6.6	PA 6*
	1241172-6	1534075-6	1,568	-	-
	1-1241172-6	1-1534075-6	1,568	-	-
	2-1241172-6	2-1534075-6	1,568	-	-
	1241172-7	1534075-7	1,372	-	-
	1-1241172-7	1-1534075-7	1,372	-	-
	1241172-8	1534075-8	1,176	-	-
	1-1241172-8	1-1534075-8	1,176	-	-

*)According to IEC 60695-2-1/1; GWT (Glow Wire Test) 750 °C without flame, see VDE M-Test Report.
The final keying version will be produced on the Application Tooling Equipment.

Indirect Mating Connector System

Technical Data

Wire Size Range:
0.35–1.0 mm²

Current Carrying Capacity
(max.):
10 A

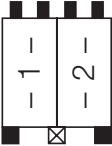
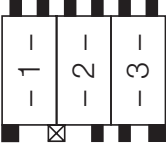
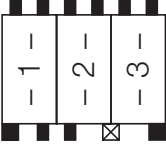
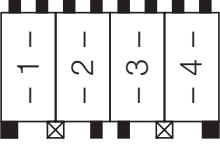
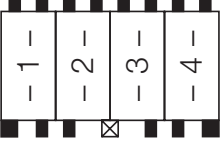
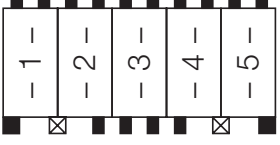
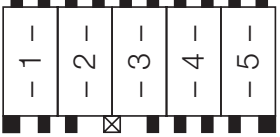
RAST 5 Version	Part Numbers with Exterior Locking		Package Quantity	Part Numbers with Interior Locking	
	PA 6.6	PA 6*		PA 6.6	PA 6*
	1241170-1	1534072-1	9,604	1241170-1	1534072-1
	1241170-2	1534072-2	4,900	1394355-2	1534077-2
	1241170-3	1534072-3	3,136	1394355-3	1534077-3
	1-1241170-3	1-1534072-3	3,136	1-1394355-3	1-1534077-3
	1241170-4	1534072-4	2,352	1394355-4	1534077-4
	1-1241170-4	1-1534072-4	2,352	1-1394355-4	1-1534077-4
	1241170-5	1534072-5	1,960	1394355-5	1534077-5
	1-1241170-5	1-1534072-5	1,960	1-1394355-5	1-1534077-5

*)According to IEC 60695-2-1/1; GWT (Glow Wire Test) 750 °C without flame, see VDE M-Test Report.
The final keying version will be produced on the Application Tooling Equipment.

Indirect Mating Connector System (continued)

Technical Data
Wire Size Range:
 0.35–1.0 mm²
**Current Carrying Capacity
(max.):**
 10 A

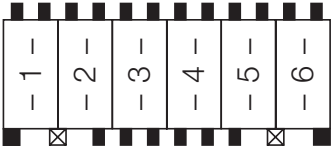
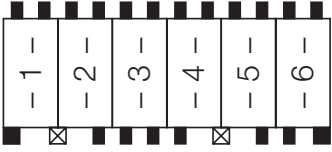
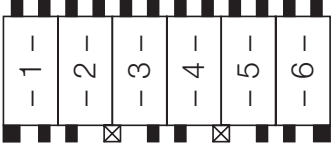
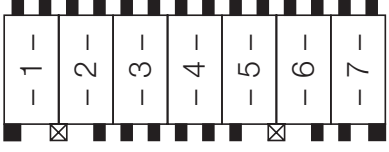
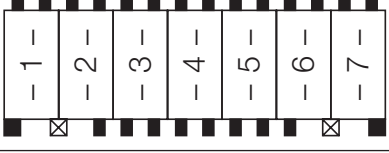
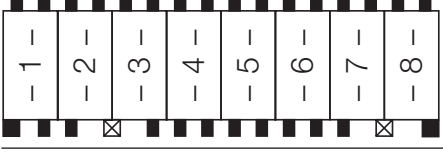
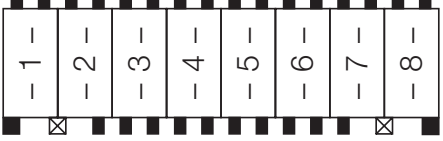
RAST 5 Version	Part Numbers with Exterior Locking		Package Quantity	Part Numbers with Interior Locking	
	PA 6.6	PA 6*		PA 6.6	PA 6*
	1241170-6	1534072-6	1,568	-	-
	1-1241170-6	1-1534072-6	1,568	-	-
	2-1241170-6	2-1534072-6	1,568	-	-
	1241170-7	1534072-7	1,372	-	-
	1-1241170-7	1-1534072-7	1,372	1394355-7	1534077-7
	1241170-8	1534072-8	1,176	-	-
	1-1241170-8	1-1534072-8	1,176	-	-

*)According to IEC 60695-2-1/1; GWT (Glow Wire Test) 750 °C without flame, see VDE M-Test Report.
 The final keying version will be produced on the Application Tooling Equipment.

Indirect Mating Connector System (continued)

Technical Data

Wire Size Range:

1.0–1.5 mm²

Current Carrying Capacity (max.):

16 A

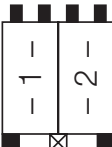
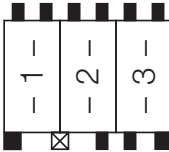
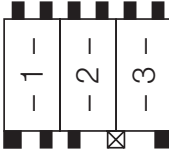
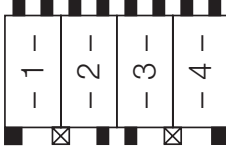
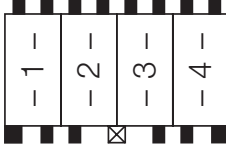
RAST 5 Version	Part Numbers with Exterior Locking		Package Quantity	Part Numbers with Interior Locking	
	PA 6.6	PA 6*		PA 6.6	PA 6*
	1241171-1	1534073-1	9,604	1241171-1	1534073-1
	1241171-2	1534073-2	4,900	1394556-2	1534078-2
	1241171-3	1534073-3	3,136	1394556-3	1534078-3
	1-1241171-3	1-1534073-3	3,136	1-1394556-3	1-1534078-3
	1241171-4	1534073-4	2,352	1394556-4	1534078-4
	1-1241171-4	1-1534073-4	2,352	1-1394556-4	1-1534078-4

*)According to IEC 60695-2-1/1; GWT (Glow Wire Test) 750 °C without flame, see VDE M-Test Report.
The final keying version will be produced on the Application Tooling Equipment.

PC Board Frame

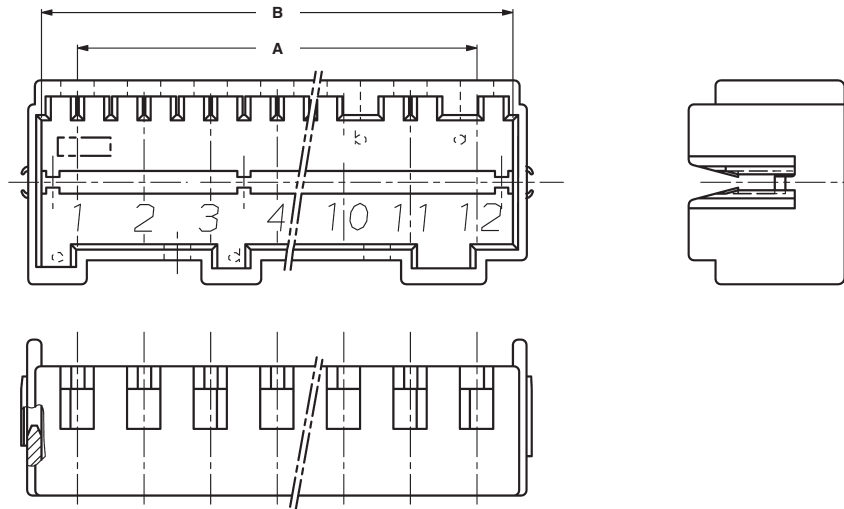
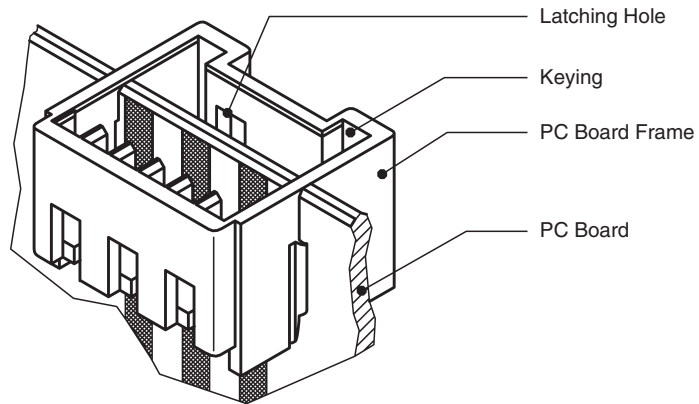

No. of Positions	Dimensions (mm)		Keying	Latching	Polarisation	Additional Board Lock	Part Number	Package Quantity
	A	B					PC Board Frame, PA 6.6, Black	
2	5	10.1	1c, 2d	1/2	-	-	2-964577-2	2,200
			1c, 2d, 3c	1/2, 3/4	2b	-	1-964577-4	
4	15	20.1	1c, 3c, 4d	1/2, 3/4	4b	-	2-964577-4	1,700
			1c, 3c, 4d	1/2, 3/4	1b, 4a	-	3-964577-4	
5	20	25.1	3d	1/2, 4/5	-	-	1-964577-5	1,500
6	25	30.1	4d	1/2, 5/6	6b	-	1-964577-6	1,500
			4d	1/2, 5/6	1b, 6a	-	2-964577-6	
7	30	35.1	2c, 3d, 7c	2/3, 5/6	1b, 2b	4/5	1-964577-7	1,200
			2c, 3d, 7c	2/3, 5/6	2b, 7a	4/5	2-964577-7	
8	35	40.1	2c, 3d, 7c	2/3, 7/8	2a	4/5	1-964577-8	1,000
			2c, 3d, 7c	2/3, 7/8	2b, 4b	4/5	2-964577-8	
12	55	60.1	1c, 2d, 3c, 4d, 5c, 8c, 10d, 12d	1/2, 3/4, 5/6, 8/9, 9/10, 11/12	2b, 3a, 4a, 6a, 7a, 7b, 8a, 8b	4/5, 8/9	1-964578-2	500

Preferred Parts are printed bold

Introduction

AMP MONO-SHAPE Connectors in In-Line Mating Technology

AMP MONO-SHAPE connectors represent a valid solution to the ever-increasing requirements for production and application flexibility. They are high productivity, great flexibility, quality, minimum applied cost. AMP MONO-SHAPE product-line includes a full range of 5.0 mm pitch modular connectors contents with similar outer shape, several variation in the mating area such as PC Board and 6.3 x 0.8 mm tabs (RAST 5), plus a version for harness shunts.

AMP MONO-SHAPE connection system adopts the IDC termination technology, which improves application results and quality level.

The AMP MONO-SHAPE product range, combined with the performances and properties offered by the termination system, allow to manufacture extremely complicated harness structures while still maintaining high production levels.

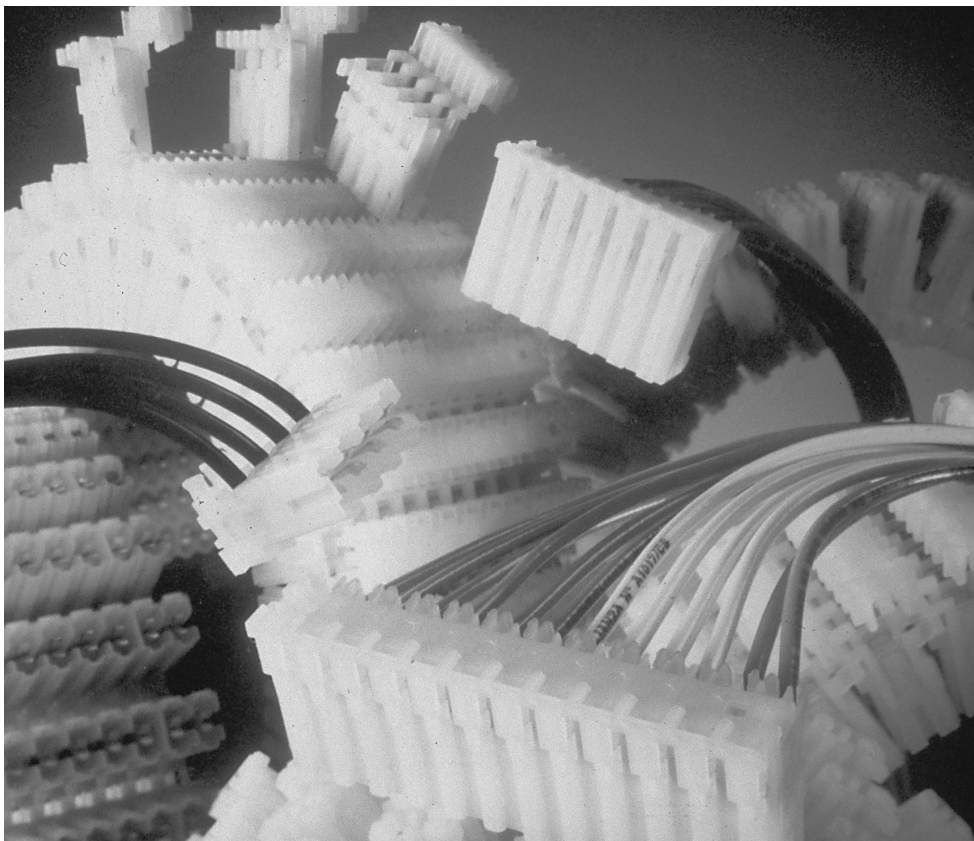

Technical Features

- IDC Connector system design to maximise the full integration with the application tooling assuring total flexibility in harness design.
- High current system, up to 16 Ampere, designed to satisfy several appliance requirements.
- ID Contact designed to accept standard discrete wires ranging from 0.5 up to 1.5 mm², according to the connector configuration.
- The connector incorporates modern in-line mating technology on a 5.0 mm centerline with no loss of spacing and a variety of keying possibilities.
- Wiring faults eliminated through high automation.
- Approvals:
VDE: 4751-1431-4024 / A
10A and
4751-1431-4024 / A 9E
UL E 28476 Vol. 9 Sec. 7;
97 ME 17936; AP-27HB

AMP MONO-SHAPE Connector Versions

Same Shape - Different Applications

With the same outside shape four connector versions are available, which are to handle with the same application tooling.

TAB Connectors

2–12 position 5.0 mm pitch connectors with insulation displacement contacts mateable with components according to RAST 5 and with tinned copper alloy tab 6.3 x 0.8 mm according to DIN 46244.

Wire Size Range:
0.5–1.5 mm²

Current Rating:
16 Ampere max. acc. to wire size

-For LIF version up to 10 Ampere max

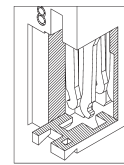
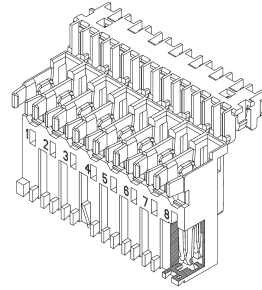

LIF version 2 point contact instead of 4 as per standard version

Single Way Connectors

Single Way connectors with insulation displacement contacts for use on tinned copper alloy tab 6.3 x 0.8 mm according to DIN 46244.

Wire Size Range:
0.5–1.5 mm²

Current Rating:
16 Ampere max. acc. to wire size

Supply Status:
In order to increase productivity these items are supplied in sticks.

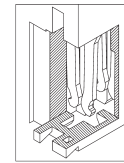
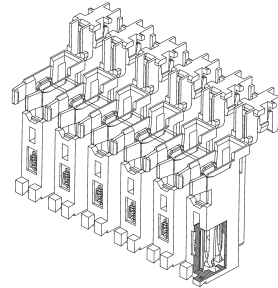

PCB Connectors

2–12 position 5.0 mm pitch connectors with insulation displacement contacts according to printed circuit boards with thickness 1.5±0.2 mm and 5.0 mm pitch.

Wire Size Range:
0.5–0.75 mm²

Current Rating:
6 Ampere max. acc. to wire size

PC Board:
Single or both sides printed 5 µm tin over 35 µm copper

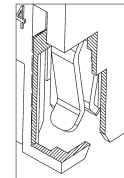
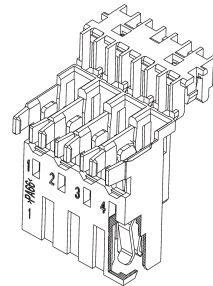

Satellite Connectors

3 position connectors, pitch 5.0 mm, with short circuited insulation displacement contacts for harness shunts.

Wire Size Range:
0.5–1.5 mm²

Current Rating:
16 Ampère max. acc. to wire size

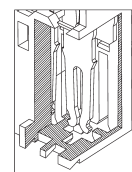
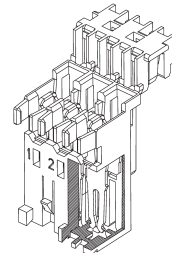

TAB Connector

AMP MONO-SHAPE TAB Connector

- 1 Cover closed after Wire Insertion. Wire Direction 90°. 180° when locked in Cover Recess
- 2 Cavity Numbers
- 3 Polarisation similar to the Keying (Located on the Back Side)
- 4 Keying
- 5 Interior Locking Latch
- 6 Colour Marking

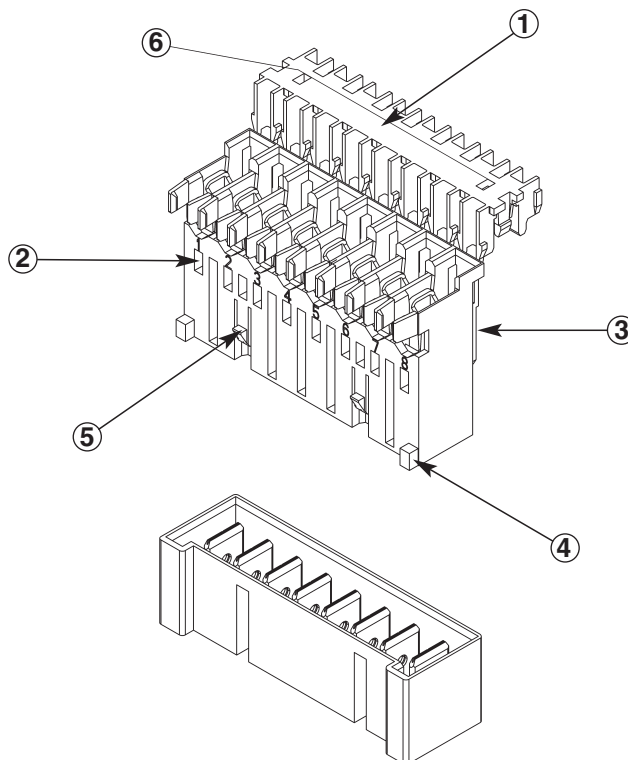

2

Rast 5

Technical Features

Centerline:
5.0 mm, according to RAST 5 specifications

Configurations:
2- to 12-positions

Housing Material:
Plastic PA 6.6

Housing Colour:
Natural colour for standard version
Grey colour for LIF version

Contact Material:
Copper alloy, post-tinned
2.0 µm min.

Polarisation, Keying, Locking Latches:
according to RAST 5 specifications
(see customer drawings)

Track Resistance:
as per IEC 112 (250 V)

Glow Wire Test:
as per IEC 695-2-1 (850 °C)
and 750°C no flame

Air and Creepage Distance:
according to EN 60998-1
(IEC 998-1) for 380 V, ≥4.0 mm

Voltage Resistance:
according to EN 60998-1
(IEC 998-1) 1750 V for 4 minutes

Insulation Resistance:
according to EN 60998-1
(IEC 998-1) >5 MΩ

Wire Size Range:
from 0.5 to 1.5 mm²

Current Rating:
Standard Version
16 A max. according to wire size
0.5 mm² ≤ 3 A, 0.75 mm² ≤ 6 A,
1.0 mm² ≤ 10 A, 1.5 mm² ≤ 16 A

LIF Version
10 A max. according to wire size
0.5 mm² ≤ 3 A, 0.75 mm² ≤ 6 A,
1.0 mm² ≤ 10 A, 1.5 mm² ≤ 10 A

Rated Voltage:
380 Volts max.

Wire Type:
H05V-K (70 °C max.)
or FR 3/2 (105 °C max.)
for 0.5–1.0 mm² wires with
copper or tinned stranded wires
H07V-K (70 °C max.)

or FR 3/2 (105 °C max.)
for wires from 1.5 mm² with
copper or tinned stranded wires

Insulation Type:
PVC suitable for temperatures
up to 70 °C / 105 °C

Insulation Diameter Range:
2.0–3.5 mm

Temperature Range:
–25 °C up to +105 °C

Wire Extraction Force/Way:
50 N min. on wire size 0.5 mm²

Application Specification:
114-20016

Product Specification:
Standard version: 108-20065
LIF version: 108-20215

Homologations:
acc.to VDE File No. 3905
(to 16 A) and UL File No.
E28476 (to 14 A)

Keying Plan

Keying Plan from Mating Direction,

- 1 Locking Latch
- 2 Slanted Keying Rib
- 3 Keying Rib
- 4 Polarisation Rib
- 5 Cavity Number

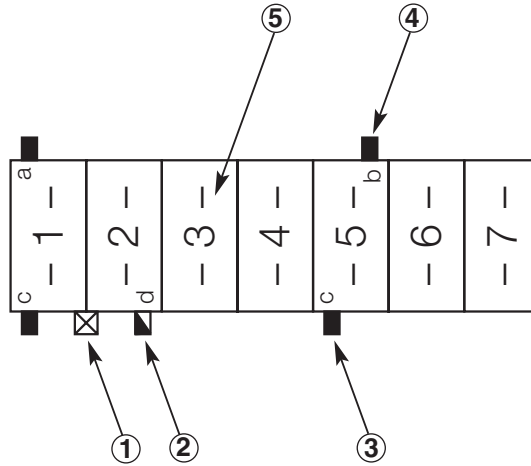

AMP MONO-SHAPE TAB Connector

2 Position RAST 5 Variations (Variable Keying)*

Suitable for RAST 5 Version Colour Marking	RAST 5 Version	Part Numbers			Packaging Unit		
		On Tray	Loose Piece	On Reel	On Reel	Loose Piece	On Reel
02-B 02-E 02-F Grey		1-282002-2 1-284338-2	2-282002-2 2-284338-2	3-282002-2 —	6.500	3.500	28.500
02-C Black		1-282002-1 1-284338-1	2-282002-1 2-284338-1	2-282002-1 —	6.500	3.500	28.500
02-L 02-P Red		1-282002-3 1-284338-3	2-282002-3 2-284338-3	— 3-284338-3	6.500	3.500	28.500
02-A 02-O Blue		1-282002-4 1-284338-4	2-282002-4 —	— —	6.500	3.500	—
02-Q Black		1-282002-5	2-282002-5	—	6.500	3.500	—
— Black		1-282002-6	2-282002-6	—	6.500	3.500	—
— —		1-282002-7 1-284338-7	2-282002-7 —	3-282002-7 —	6.500	3.500	28.500

* Final keying version is produced on the Application Tooling Machines.

Bold Part Numbers are LIF Version

AMP MONO-SHAPE TAB Connector

3 Position RAST 5 Variations (Variable Keying)*

Suitable for RAST 5 Version Colour Marking	RAST 5 Version	Part Numbers			Packaging Unit		
		On Tray	Loose Piece	On Reel	On Reel	Loose Piece	On Reel
03-A 03-I Orange		1-282003-1 1-284339-1	2-282003-1 2-284339-1	3-282003-1 —	4.160	2.500	24.000
03-B 03-K Blue		1-282003-2 1-284339-2	2-282003-2 2-284339-2	3-282003-2 —	4.160	2.500	24.000
03-F Green		1-282003-3 1-284339-3	2-282003-3 2-284339-3	— —	4.160	2.500	—
03-D —		282233-2	282233-2	—	4.160	2.500	—
03-B 03-K Red		1-282003-4 1-284339-4	2-282003-4 2-284339-4	— —	4.160	2.500	—
03-B 03-K Grey		1-282003-5 1-284339-5	2-282003-5 2-284339-5	— —	4.160	2.500	—
— Violet		1-282003-6	2-282003-6	—	4.160	2.500	—
03-B Black		1-282003-7	—	—	4.160	—	—
— Black		1-284396-1	—	—	4.160	—	—

* Final keying version is produced on the Application Tooling Machines.
Bold Part Numbers are LIF Version

2
Rast 5

AMP MONO-SHAPE TAB Connector

4 Position RAST 5 Variations (Variable Keying)*

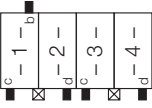
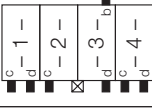
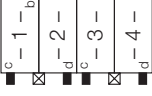
Suitable for RAST 5 Version Colour Marking	RAST 5 Version	Part Numbers			Packaging Unit		
		On Tray	Loose Piece	On Reel	On Reel	Loose Piece	On Reel
04-A Grey		1-282004-1	2-282004-1	3-282004-1	2.120	2.000	18.750
04-D Black		1-282004-2	2-282004-2	3-282004-2	2.120	2.000	18.750
04-A Red		1-282004-3	2-282004-3	—	2.120	2.000	—

5 Position RAST 5 Variations (Variable Keying)*

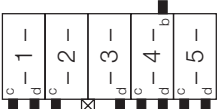
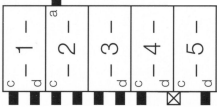
Suitable for RAST 5 Version Colour Marking	RAST 5 Version	Part Numbers			Packaging Unit		
		On Tray	Loose Piece	On Reel	On Reel	Loose Piece	On Reel
Red		1-282005-1	2-282005-1	—	2.600	1.500	18.750
Red		1-284545-1	—	—	2.600	1.500	18.750

* Final keying version is produced on the Application Tooling Machines.

AMP MONO-SHAPE TAB Connector

6 Position RAST 5 Variations (Variable Keying)*

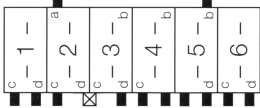
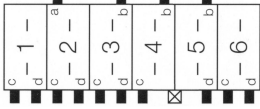
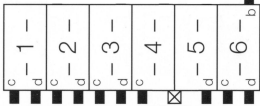
Suitable for RAST 5 Version Colour Marking	RAST 5 Version	Part Numbers			Packaging Unit		
		On Tray	Loose Piece	On Reel	On Reel	Loose Piece	On Reel
Violet		1-282006-1	2-282006-2	3-282006-2	2.080	1.200	13.500
—		1-282006-3	2-282006-3	3-282006-3	2.080	1.200	13.500
Red		1-284745-1	—	—	2.080	—	—

7 Position RAST 5 Variations (Variable Keying)*

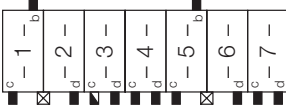
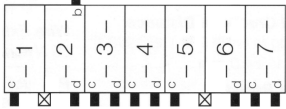
Suitable for RAST 5 Version Colour Marking	RAST 5 Version	Part Numbers			Packaging Unit		
		On Tray	Loose Piece	On Reel	On Reel	Loose Piece	On Reel
—		1-282007-1	2-282007-1	—	1.820	1.200	—
Black		1-284397-1	—	—	1.820	1.200	—

AMP MONO-SHAPE TAB Connector

8 Position RAST 5 Variations (Variable Keying)*

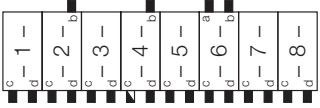
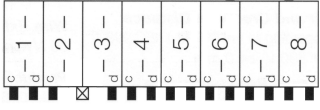
Suitable for RAST 5 Version Colour Marking	RAST 5 Version	Part Numbers			Packaging Unit		
		On Tray	Loose Piece	On Reel	On Reel	Loose Piece	On Reel
—		284085-1 1-284685-1	2-284085-1 2-284685-1	— —	1.560	900	—
Violet		284085-2	2-284085-2	—	1.560	900	—

* Final keying version is produced on the Application Tooling Machines.
Bold Part Numbers are LIF Version

10 Position RAST 5 Variations (Variable Keying)*

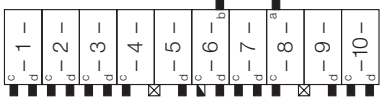
Suitable for RAST 5 Version Colour Marking	RAST 5 Version	Part Numbers			Packaging Unit		
		On Tray	Loose Piece	On Reel	On Reel	Loose Piece	On Reel
—		1-282010-1 1-284686-1	2-282010-1 2-284686-1	— —	1.300	700	—

* Final keying version is produced on the Application Tooling Machines.
Bold Part Numbers are LIF Version

AMP MONO-SHAPE Single Way Connector

Single Way Connector

- 1 All Single Way Connectors are supplied in "stick-form" by 6 single ways each. They will be cut from the Application Tooling Machines
- 2 Cover closed after Wire Insertion. Wire Direction 90°. 180° when locked in Cover Recess
- 3 Polarisation similar to the keying of the front side
- 4 Keying
- 5 Plastic Noses which Lock into the TAB Hole
- 6 Colour Marking

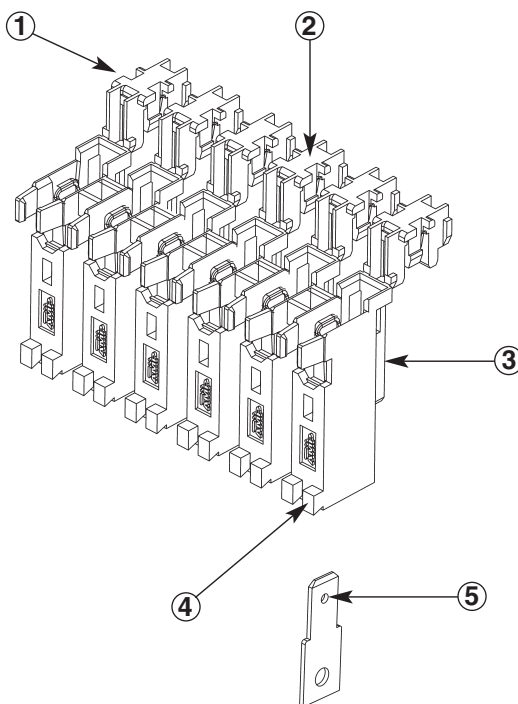

2

Rast 5

Technical Features

Centerline:
5.0 mm, according to RAST 5 specifications

Configurations:
1 position

Housing Material:
Plastic PA 6.6

Housing Colour:
Natural colour

Contact Material:
Copper alloy, post-tinned
2.0 µm min.

Polarisation, Keying, Locking Latches:
according to RAST 5 specifications
(see customer drawings)

Track Resistance:
as per IEC 112 (250 V)

Glow Wire Test:
as per IEC 695-2-1 (850 °C)
and 750°C no flame

Air and Creepage Distance:
according to EN 60998-1
(IEC 998-1) for 380 V, ≥4.0 mm

Voltage Resistance:
according to EN 60998-1
(IEC 998-1) 1750 V for 4 minutes

Insulation Resistance:
according to EN 60998-1
(IEC 998-1) >5 MΩ

Wire Size Range:
from 0.5 to 1.5 mm²

Current Rating:
16 A max. according to wire size
0.5 mm² ≤3 A, 0.75 mm² ≤6 A,
1.0 mm² ≤10 A, 1.5 mm² ≤16 A

Rated Voltage:
380 Volts max.

Wire Type:
H05V-K (70 °C max.)
or FR 3/2 (105 °C max.)
for 0.5–1.0 mm² wires with
copper or tinned stranded wires
H07V-K (70 °C max.)
or FR 3/2 (105 °C max.)
for wires from 1.5mm² with
copper or tinned stranded wires

Insulation Type:
PVC suitable for temperatures
up to 70 °C / 105 °C

Insulation Diameter Range:
2.0–3.5 mm

Temperature Range:
–25 °C up to +105 °C

Wire Extraction Force/Way:
50 N min. on wire size 0.5 mm²

Application Specification:
114-20017

Product Specification:
108-20066

Homologations:
acc.to VDE File No. 3905
(to 16 A) and UL File No.
E28476 (to 14 A)

Counter Part:
Tab 6.3 x 0.8 mm
as per DIN 46244 norms

Materials:
Copper alloy

Finishing:
Tinned (6.0 µm max.)

Keying Plan from Mating Direction

Keying Plan

- 1 Keying Rib
- 2 Polarisation Rib
- 3 Cavity Number

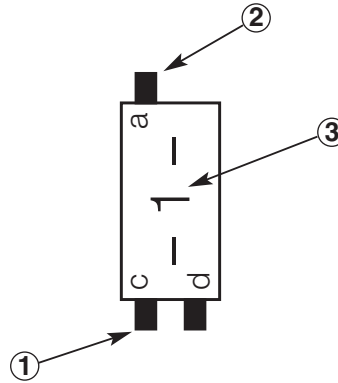

AMP MONO-SHAPE Single Way Connector

1 Position (Variable Keying)*

Suitable for RAST 5 Version Colour Marking	RAST 5 Version	Part Numbers		Packaging Unit	
		On Tray	On Reel	On Tray	On Reel
—		—	1-282086-1	1.024	10.500
Black		—	1-282086-2	1.024	—
Orange		—	1-282086-3	1.024	—
Green		—	1-282086-4	1.024	—
Blue		—	1-282086-5	1.024	—
Violet		—	1-282086-6	1.024	—

AMP MONO-SHAPE PCB (Printed Circuit Board) Connector

PCB Connector

- 1 Cover closed after Wire Insertion.
Wire Direction 90°. 180° when locked in Cover Recess
- 2 Cavity Numbers
- 3 Keying Slot in PC Board
- 4 Locking Hole in PC Board
- 5 Colour Marking

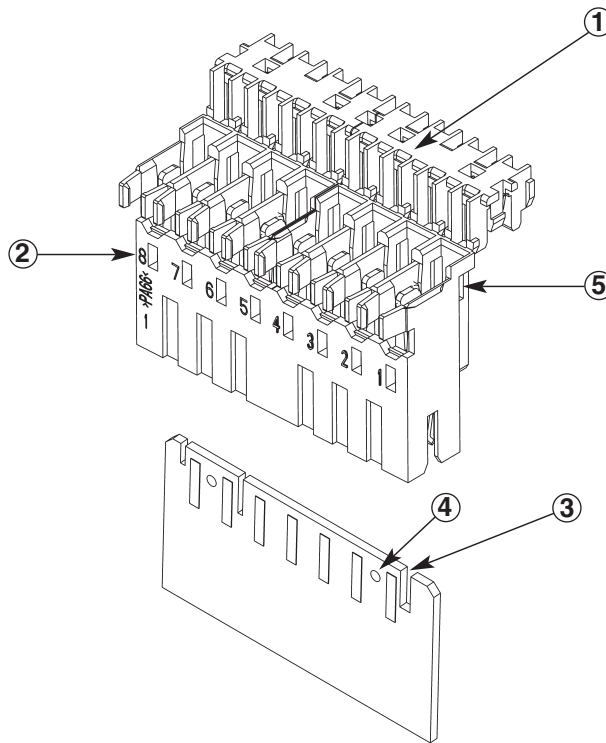

2

Rast 5

Technical Features

Centerline:
5.0 mm

Configurations:
2-12 positions

Housing Material:
Plastic PA 6.6

Housing Colour:
Natural colour

Contact Material:
Copper alloy, post-tinned
2.0 µm min.

Polarisation, Keying, Locking Latches:
according to RAST 5 specifications
(see customer drawings)

Track Resistance:
as per IEC 112 (250 V)

Glow Wire Test:
as per IEC 695-2-1 (850 °C)
and 750°C no flame

Air and Creepage Distance:
according to EN 60998-1
(IEC 998-1) for 240 V, ≥3.0 mm

Voltage Resistance:
according to EN 60998-1
(IEC 998-1) 1750 V for 4 minutes

Insulation Resistance:
according to EN 60998-1
(IEC 998-1) >5 MΩ

Wire Size Range:
from 0.5 to 0.75 mm²

Current Rating:
6 A max. according to wire size
0.5 mm² ≤3 A, 0.75 mm² ≤6 A

Rated Voltage:
220 Volts max.

Wire Type:
H05V-K (70 °C max.)
or FR 3/2 (105 °C max.)
for 0.5–1.0 mm² wires with
copper or tinned stranded wires
H07V-K (70 °C max.)
or FR 3/2 (105 °C max.)
for wires from 1.5mm² with
copper or tinned stranded wires

Insulation Type:
PVC suitable for temperatures
up to 70 °C / 105 °C

Insulation Diameter Range:
2.0–2.8 mm

Temperature Range:
–25 °C up to +105 °C

Wire Extraction Force/Way:
50 N min. on wire size 0.5 mm²

Application Specification:
114-20025

Product Specification:
108-20067

Homologations:
acc.to VDE File No. 3905
(to 6 A) and UL File No. E28476
(to 6 A)

Printed Circuit Board:
Thickness 1.5±0.2mm

Tinned Circuit Paths:
5.0mm pitch and width of
1.8mm

AMP MONO-SHAPE PCB (Printed Circuit Board) Connector

PCB Connector

- 1 PC Board
- 2 First Circuit Path
- 3 MONO-SHAPE Connector
- 4 Wire

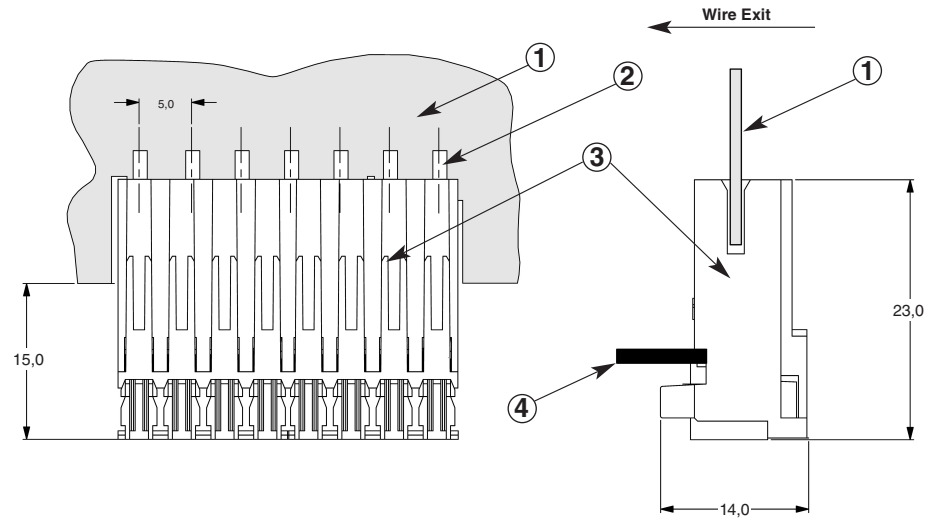

Notes Concerning the PC Board Layout

- 1 First circuit path
- 2 Slot for keying rib in front of first cavity (according to the connector 4.0 mm or 7.4 mm)
- 3 Bore hole for locking clip symmetric between two cavities (diameter 2.5 mm)
- 4 Slot for keying rib symmetric between two cavities

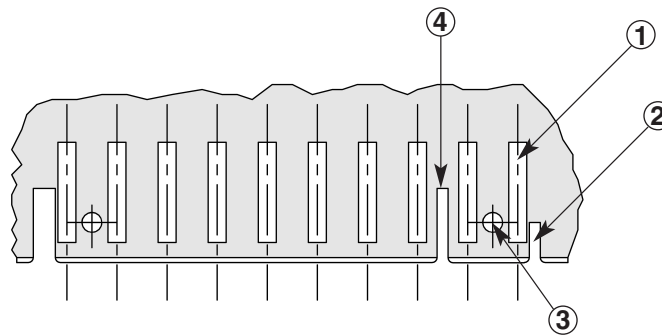

PC Board Layout Dimensions on request.

See Customer Drawing 282042



AMP MONO-SHAPE PCB (Printed Circuit Board) Connector

Centerline 5.0 mm

No. of Positions Colour Marking	PC Board Cut-Out	Part Numbers			Packaging Unit		
		On Tray	Loose Piece	On Reel	On Reel	Loose Piece	On Reel
2 Brown		1-282042-1	2-282042-1	—	5.980	3.500	—
2 Green		1-282042-2	2-282042-2	3-282042-2	5.980	3.500	28.500
2 Blue		1-282042-3	2-282042-3	3-282042-3	5.980	3.500	28.500
2 Red		1-282042-4	2-282042-4	—	5.980	3.500	—
2 Black		1-282042-5	2-282042-5	3-282042-5	5.980	3.500	28.500
3 —		1-282043-2	2-282043-2	3-282043-2	4.160	2.500	24.000
3 Black		1-282043-3	2-282043-3	—	4.160	2.500	—
3 —		282235-2	2-282235-2	—	4.160	2.500	—
3 Black		282235-3	2-282235-3	—	4.160	2.500	—
3 Blue		1-1284546-1	—	—	4.160	—	—
4 —		1-282044-1	2-282044-1	3-282044-1	3.120	2.000	18.750

AMP MONO-SHAPE PCB (Printed Circuit Board) Connector

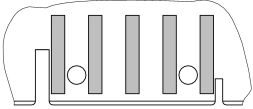
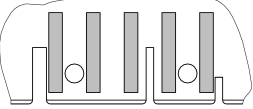
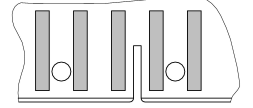
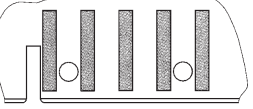
Centerline 5.0 mm (continued)

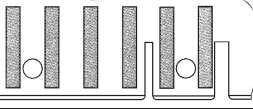
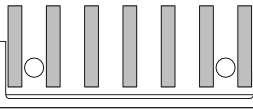
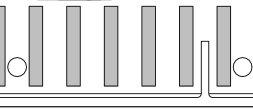
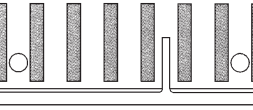
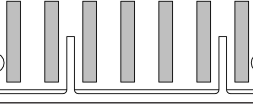
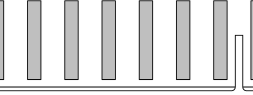
No. of Positions Colour Marking	PC Board Cut-Out	Part Numbers			Packaging Unit		
		On Tray	Loose Piece	On Reel	On Reel	Loose Piece	On Reel
5 —		1-282045-1	2-282045-1	3-282045-1	2.600	1.500	18.750
5 Green		1-282045-2	2-282045-2	3-282045-2	2.600	1.500	18.750
5 —		1-282045-3	2-282045-3	3-282045-3	2.600	1.500	18.750
5 —		1-284733-1	2-284733-1	3-284733-1	2.600	1.500	18.750
6 —		1-282046-1	2-282046-1	3-282046-1	2.080	1.200	13.500
6 —		1-284734-1	2-284734-1	3-284734-1	2.080	1.200	13.500
7 —		1-282047-1	2-282047-1	3-282047-1	1.820	1.200	13.500
8 —		284208-1	2-284208-1	—	1.560	900	—
8 —		284574-1	—	—	1.560	—	—
9 —		1-282049-1	2-282049-1	3-282049-1	1.300	700	10.500
10 —		1-282050-1	2-282050-1	3-282050-1	1.300	700	10.500

AMP MONO-SHAPE PCB (Printed Circuit Board) Connector

Centerline 5.0 mm (continued)

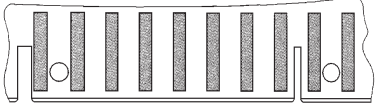
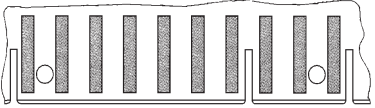
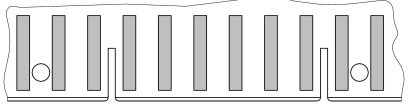
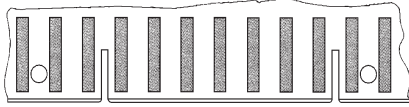
No. of Positions Colour Marking	PC Board Cut-Out	Part Numbers			Packaging Unit		
		On Tray	Loose Piece	On Reel	On Reel	Loose Piece	On Reel
10 Black		1-284401-1	—	—	1.300	—	—
10 —		284575-1	—	—	1.300	—	—
11 —		1-282051-1	2-282051-1	3-282051-1	1.040	700	10.500
12 —		1-282052-1	2-282052-1	3-282052-1	1.040	700	10.500

2

Part 5

AMP MONO-SHAPE Satellite Connector

Satellite Connector

- 1 Cover closed after Wire Insertion. Wire Direction 90°. 180° when locked in Cover Recess
- 2 Bridge between Contacts to have Short Circuit
- 3 Cavity Numbers
- 4 For Satellite version, the cavity 1 only accept TAB contact, other cavities are clogged

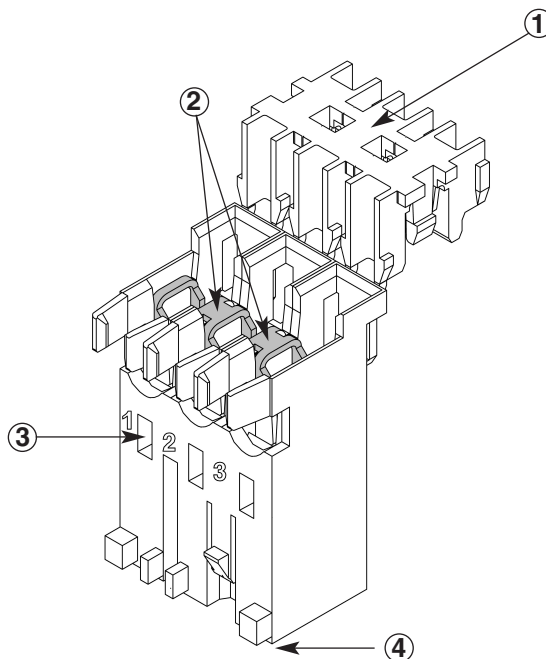

Technical Features

Centerline:

5.0 mm, according to RAST 5 specifications

Configurations:

3 positions only (for special version please contact Tyco Electronics)

Housing Material:

Plastic PA 6.6

Housing Colour:

Natural colour

Contact Material:

Copper alloy, post-tinned
2.0 µm min.

Polarisation, Keying,

Locking Latches:
according to RAST 5 specifications
(see customer drawings)

Track Resistance:

as per IEC 112 (250 V)

Glow Wire Test:

as per IEC 695-2-1 (850 °C)
and 750°C no flame

Air and Creepage Distance:

according to EN 60998-1
(IEC 998-1) for 380 V, ≥4.0 mm

Voltage Resistance:

according to EN 60998-1
(IEC 998-1) 1750 V for 4 minutes

Insulation Resistance:

according to EN 60998-1
(IEC 998-1) >5 MΩ

Wire Size Range:

from 0.5 to 1.5 mm²

Current Rating:

16 A max. according to wire size
0.5 mm² ≤3 A, 0.75 mm² ≤6 A,
1.0 mm² ≤10 A, 1.5 mm² ≤16 A

Rated Voltage:

380 Volts max.

Wire Type:

H05V-K (70 °C max.)
or FR 3/2 (105 °C max.)
for 0.5–1.0 mm² wires with
copper or tinned stranded wires

H07V-K (70 °C max.)

or FR 3/2 (105 °C max.)

for wires from 1.5mm² with
copper or tinned stranded wires

Insulation Type:

PVC suitable for temperatures
up to 70 °C / 105 °C

Insulation Diameter Range:

2.0–3.5 mm

Temperature Range:

–25 °C up to +105 °C

Wire Extraction Force/Way:

50 N min. on wire size 0.5 mm²

Application Specification:

114-20026

Product Specification:

108-20070

Homologations:

acc.to VDE File No. 3905
(to 16 A) and UL File No.
E28476 (to 14 A)

Keying Plan from Mating Direction

Keying Plan

- 1 Locking Latch
- 2 Keying Rib
- 3 Polarisation Rib
- 4 Cavity Number

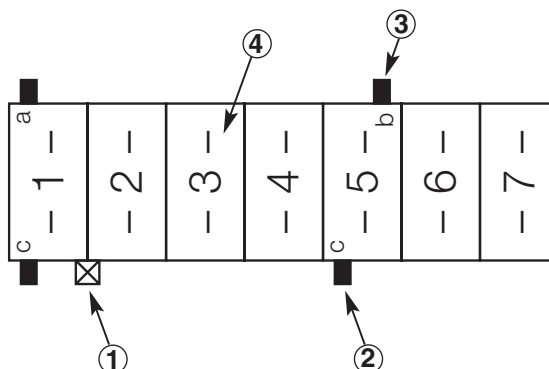

AMP MONO-SHAPE - 3 Position Satellite Connector (Variable Keying)*

Suitable for RAST 5 Version Colour Marking	RAST 5 Version	Part Numbers			Packaging Unit		
		On Tray	Loose Piece	On Reel	On Reel	Loose Piece	On Reel
03-A 03-I Black		1-282099-1	—	—	4.160	—	—

AMP MONO-SHAPE - 2 Position Satellite Connector

(Variable Keying)* Bridge between Contacts. Cavity Numbers 1-2 to have Short Circuit

02-L 02-P —		1-284288-1	284288-1	—	6.500	—	—
02-L 02-P Orange		—	284288-2	—	—	3.000	—
02-L 02-P Blue		1-284288-3	284288-3	—	6.500	3.000	—
02-L 02-P Green		—	284288-4	—	—	3.000	—
02-L 02-P Violet		—	284288-5	—	—	3.000	—
02-L 02-P Black		1-284288-6	284288-6	—	6.500	3.000	—
02-C —		—	284288-7	—	—	3.000	—

* Final keying version is produced on the Application Tooling Machines.

Keying Plan from Mating Direction

AMP MONO-SHAPE Bridge Connector - 3 Position RAST 5 Variation

(Variable Keying)* Bridge between Contacts. Cavity Numbers 1-2-3 to have Short Circuit

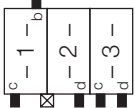
Suitable for RAST 5 Version Colour Marking	RAST 5 Version	Part Numbers			Packaging Unit		
		On Tray	Loose Piece	On Reel	On Reel	Loose Piece	On Reel
03-A 03-l Green		—	284289-1	—	—	2.500	—

AMP MONO-SHAPE Bridge Connector - 6 Position RAST 5 Variation

(Variable Keying)* Bridge between Contacts. Cavity Numbers 1-2-3 to have Short Circuit

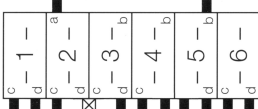
Suitable for RAST 5 Version Colour Marking	RAST 5 Version	Part Numbers			Packaging Unit		
		On Tray	Loose Piece	On Reel	On Reel	Loose Piece	On Reel
— Green		—	284290-1	—	—	1.200	—

AMP MONO-SHAPE Bridge Connector - 6 Position RAST 5 Variation

(Variable Keying)* Bridge between Contacts. Cavity Numbers 1-2 and 3-4 to have Short Circuit

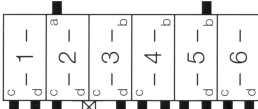
Suitable for RAST 5 Version Colour Marking	RAST 5 Version	Part Numbers			Packaging Unit		
		On Tray	Loose Piece	On Reel	On Reel	Loose Piece	On Reel
— Black		—	284290-2	—	—	1.200	—

AMP MONO-SHAPE Bridge Connector - 6 Position RAST 5 Variation

(Variable Keying)* Bridge between Contacts. Cavity Numbers 1-2-3-4-5-6 to have Short Circuit

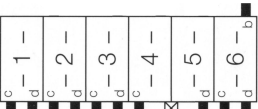
Suitable for RAST 5 Version Colour Marking	RAST 5 Version	Part Numbers			Packaging Unit		
		On Tray	Loose Piece	On Reel	On Reel	Loose Piece	On Reel
— —		1-284744-1	—	—	2.080	—	—

* Final keying version is produced on the Application Tooling Machines.

Introduction

AMP MONO-SHAPE MARK II Connectors in In-Line Mating Technology

MONO-SHAPE Mark II Connector System was developed according to the newest level of knowledge and standard.

The requirements of advanced In-Line mating technology for the component and contact of printed circuit board (PCB) is granted by the two versions TAB and PCB connector systems.

System is designed to maximise the full integration with the application tooling, assuring the flexibility in the harness design.

This system is suitable for a wide wire size range of conductor and current carrying capacity up to 16 A.

Double termination is possible with 0.5 and 0.5mm² or 0.5 and 0.75mm² conductors. (See application spec. 114-20104 for details)

The connectors are available in 1 to 10 positions (TAB Version) with interior locking device and 2 to 12 positions (PCB Version)

Connectors are supplied in chain and provided with all keying and polarisation ribs the connectors can be handled automatically with a modern Application Tooling Equipment.

Wiring faults checked and eliminated through high automation.

Application Machines shall provide to print a colour code mark on the connectors cover after wire termination, feasible on all connectors configuration, for connector identification on harnesses.

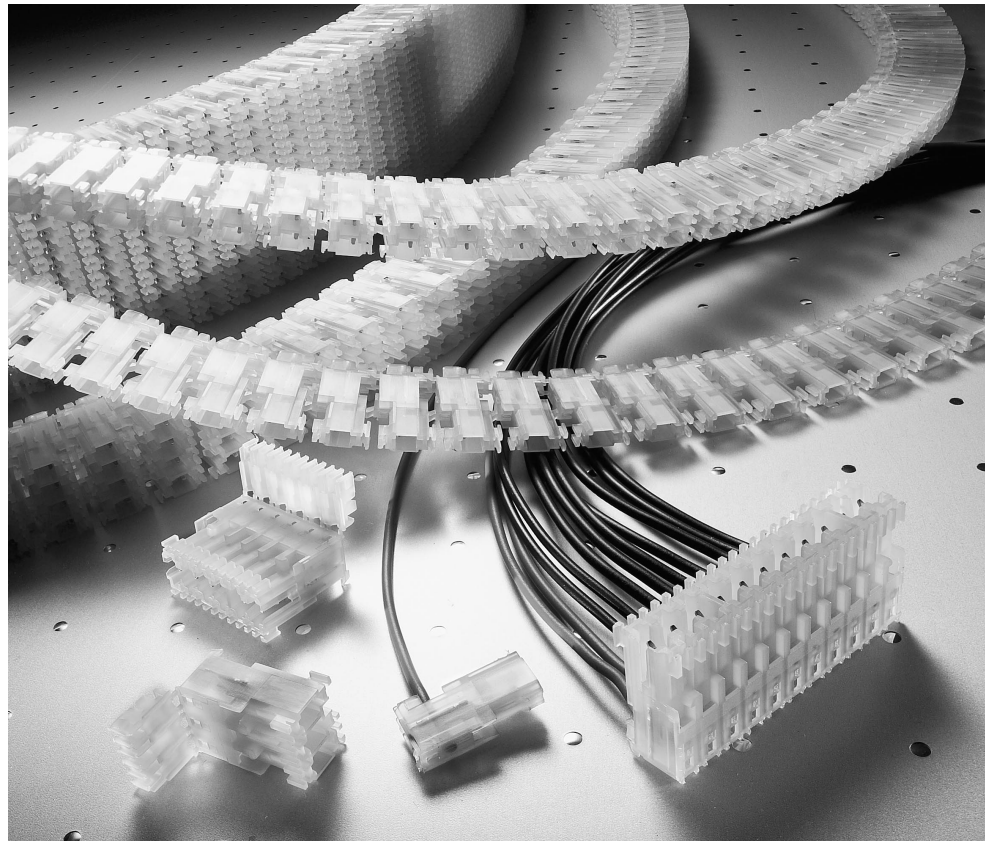

Technical Features

- Housing moulded in different materials for different applications
- Standard, Part Numbers with pre-dash 0 (as 0-284471-1) Housing in unfilled PA 6/6, UL 94V-2
- For UL94V0, Part Numbers with pre-dash 1 (as 1-284471-1) Housing in unfilled PA 6/6, UL 94V-0
- High Operating Temperature (up to 130°), Part Numbers with pre-dash 2 (as 2-284471-1) Unfilled PA 4/6, UL 94V-2 (available for TAB Version only)
- Glow Wire 750° no flame, Part Numbers with pre-dash 3 (as 3-284471-1) Housing in unfilled PA 6, UL 94V-2

Technical Data

Centerline:
5.0mm

Housing Material:
Polyamide, PA 6.6 and PA 6

Approvals:
VDE, UL CSA applied

Standard Colour:
Natural

Current Voltage:
250 V_~

Air and Creepage Distance:
>3.2mm

Flammability Rating:
According UL 94 V-2

TAB Connectors

1-10 position 5.0 pitch connectors with insulation displacement contacts mateable with components according to rast 5 and with tinned copper alloy tab contacts 6.3 x 0.8mm according to DIN 46244 and DIN 17670 Part 1.

TAB-BRIDGE Connectors

Same design as TAB Connectors but with a bridge between two adjacent contacts to have a Short Circuit between them.

Wire Size Range:
0.35–1.5 mm²

Current Rating:
16 Ampere max. acc. to
wire size used

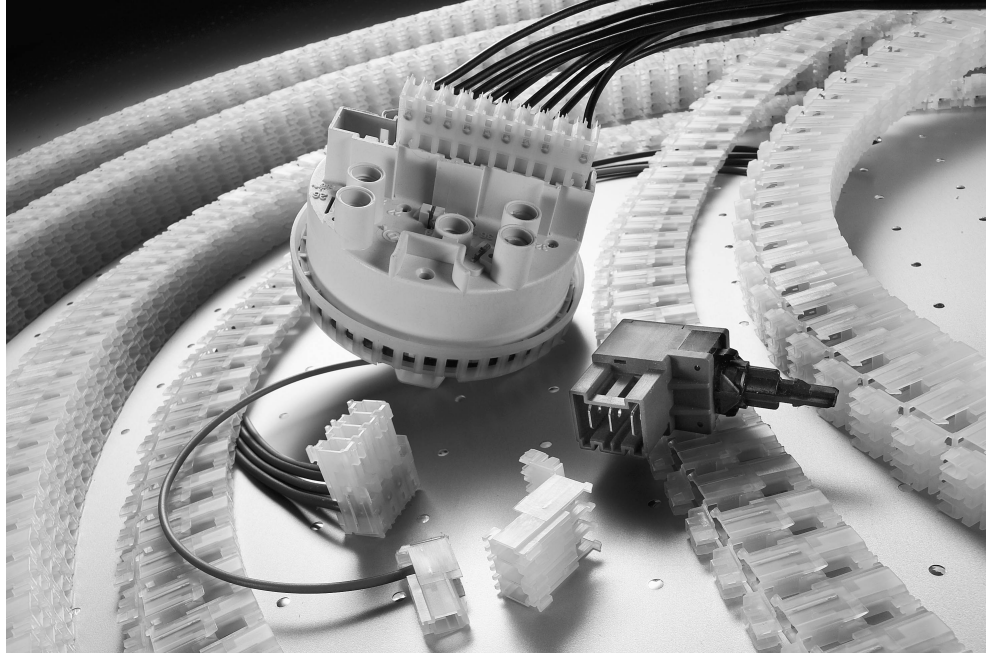

PCB Connectors

2–12 position 5.0 mm pitch connectors with insulation displacement contacts mateable with printed circuit boards (PCB)

Wire Size Range:
0.35–0.75 mm²

Current Rating:
6 Ampere max. acc. to
wire size used

PC Board:
Single or double side, with
thickness 1.6±0.2mm, FR4, 2 x
0.35 μm Copper 5μm tinned
tracks, 5.0mm pitch

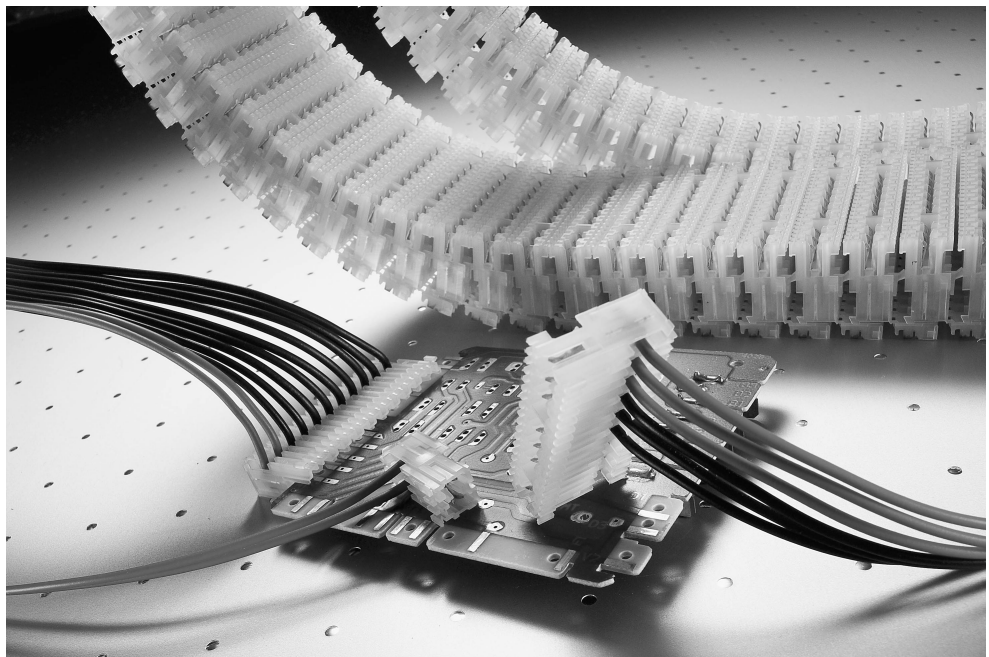

Keying Plan and Cable Exit

Keying Plan from Mating Direction, Fully Keyed Version

- 1 Locking Latch
- 2 Keying Rib
- 3 Polarisation Rib
- 4 Cavity Number
- 5 Motor Mount Special Keying

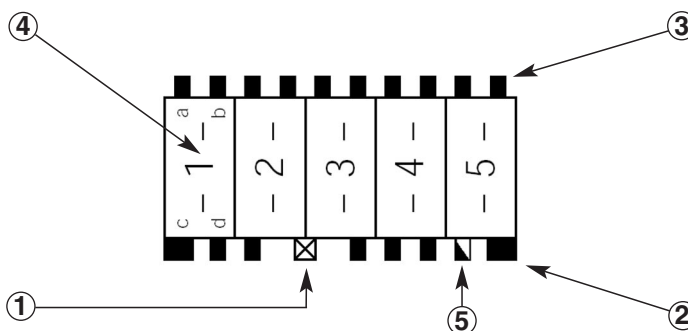

Example of Keyed Version: 05-C

This final keying version
will be produced on the
Application Tooling
Equipment

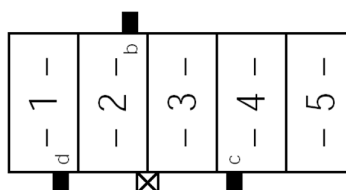

Cable Exit

- 1 Double Wire Exit
- 2 Wire Exit 90°
- 3 Wire Exit 180°
- 4 Cover
- 5 Interior Locking Latch
(for TAB Version only)
- 6 Keying
- 7 Polarisation
- 8 Motor Mount
Special Keying
- 9 Colour Marking Area to
identify connectors after
harnesses are built up

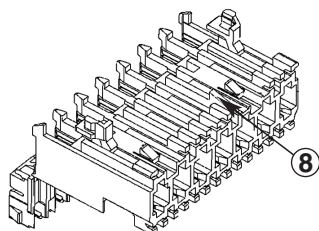
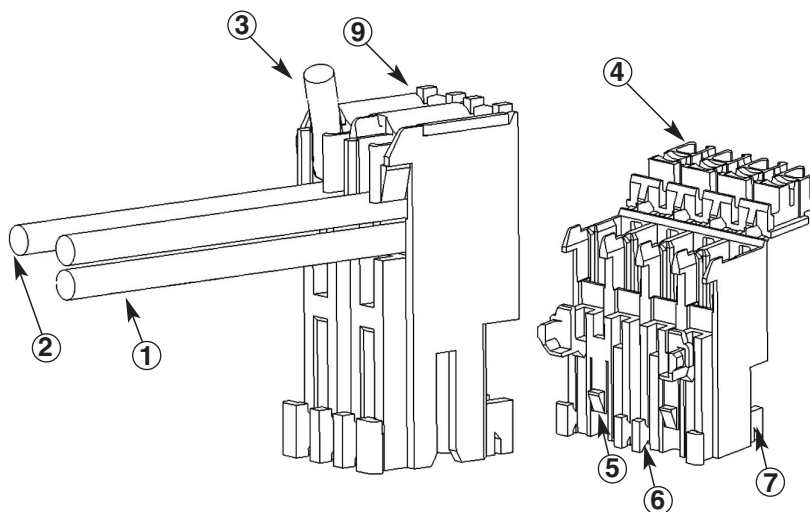

2
Rast 5

TAB Connector System

AMP MONO-SHAPE MARK II TAB Connector System

No. of Positions:
1 to 10 positions

Contact Material:
CuNi2Si

Contact Finish:
Tin Plated

Current Rating:
16 A, up to 4 contacts 16 A

Insulation Diameter:
3.0mm max.

Insulation Resistance:
>10 MΩ

Wire Size Range:
0.35-1.5mm²

Temperature Range:
-40°C up to +130°C

Product Specification:
108-20213

Application Specification:
114-20104

No. of Positions	Colour Marking as Shipped	RAST 5 Version	Part Numbers				Packaging Unit
			Standard	UL94V0	High Temperature	Glow Wire 750° no flame	
1	—		0-284471-1	1-284471-1	2-284471-1	3-284471-1	11000
2	—		0-284472-1	1-284472-1	2-284472-1	3-284472-1	5500
3	—		0-284473-1	1-284473-1	2-284473-1	3-284473-1	3520
3	Blue		0-284473-2	1-284473-2	2-284473-2	3-284473-2	3520
4	—		0-284474-1	1-284474-1	2-284474-1	3-284474-1	2640
4	Blue		0-284474-2	1-28444-2	2-284474-2	3-284474-2	2640
5	—		0-284475-1	1-284475-1	2-284475-1	3-284475-1	2200
6	—		0-284476-1	1-284476-1	2-284476-1	3-284476-1	1760
6	Violet		0-284476-4	1-284476-4	2-284476-4	3-284476-4	1760
7	—		0-284477-1	1-284477-1	2-284477-1	3-284477-1	1540

TAB Connector System (continued)

AMP MONO-SHAPE MARK II TAB Connector System

2

Rast 5

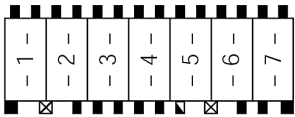
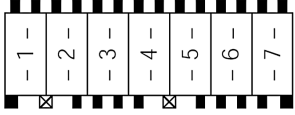
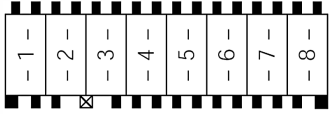
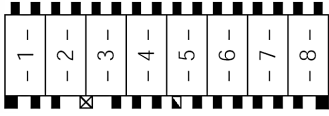
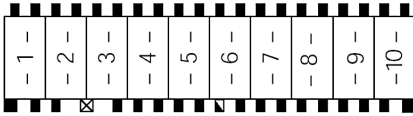
No. of Positions	Colour Marking as Shipped	RAST 5 Version	Part Numbers				Packaging Unit
			Standard	UL94V0	High Temperature	Glow Wire 750° no flame	
7	Blue		0-284477-2	1-284477-2	2-284477-2	3-284477-2	1540
7	Red		0-284477-3	1-284477-3	2-284477-3	3-284477-3	1540
8	—		0-284478-1	1-284478-1	2-284478-1	3-284478-1	1320
8	Blue		0-284478-2	1-284478-2	2-284478-2	3-284478-2	1320
10	—		0-284480-1	1-284480-1	2-284480-1	3-284480-1	1100

TAB-BRIDGE Connector System - Short Circuit

AMP MONO-SHAPE MARK II TAB-BRIDGE Connector System - Short Circuit

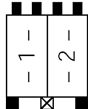
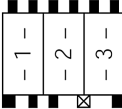
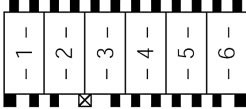
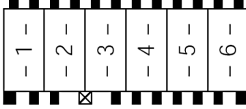
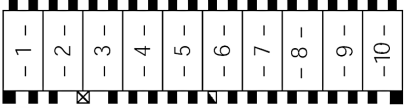
No. of Positions	Colour Marking as Shipped	RAST 5 Version	Bridge Between Cavity Numbers	Part Numbers			Packaging Unit	
				Standard	UL94V0	High Temperature		Glow Wire 750° no flame
2	Blue		1-2	0-284472-2	1-284472-2	2-284472-2	3-284472-2	5500
3	Red		1-2	0-284473-3	1-284473-3	2-284473-3	3-284473-3	3520
6	Blue		1-2-3	0-284476-2	1-284476-2	2-284476-2	3-284476-2	1760
6	Red		1-2	0-284476-3	1-284476-3	2-284476-3	3-284476-3	1760
10	Blue		7-8	0-284480-2	1-284480-2	2-284480-2	3-284480-2	1100

PCB Connector System

No. of Positions: 2 to 12 positions	Insulation Diameter: 2.8mm max.	Product Specification: 108-20214
Contact Material: Brass	Insulation Resistance: >10 MΩ	Application Specification: 114-20104
Contact Finish: Tin Plated	Wire Size Range: 0.35-0.75mm ²	
Current Rating: 6 A max.	Temperature Range: -40°C up to +105°C	

AMP MONO-SHAPE MARK II PCB Connector System

- 1 PC Board
- 2 First Circuit Path
- 3 MONO-SHAPE Connector
- 4 Wire

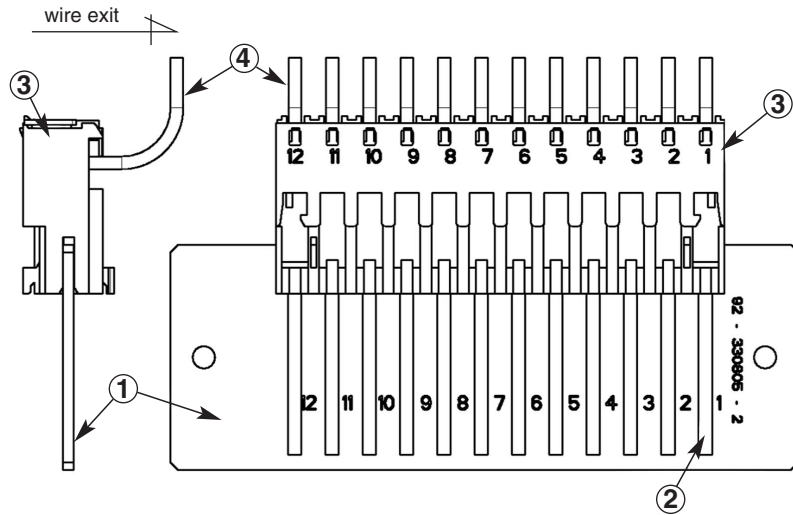

Notes Concerning the PC Board Layout

See also Customer Drawing
284482 and Drawing
93-330805-2 for Test PCB
Layout

- 1 First circuit path, mate with
Connector way No. 1
- 2 Slot for connector keying rib
Adjacent to first and/or last
way
Based on connector design,
for 3.5mm or 7.5mm length
- 3 Hole for locking clip,
symmetric
Between two ways
(diameter 2.5)
- 4 Slot for connector keying rib
symmetric between two
ways. Position based on
connector design, for
7.5mm length

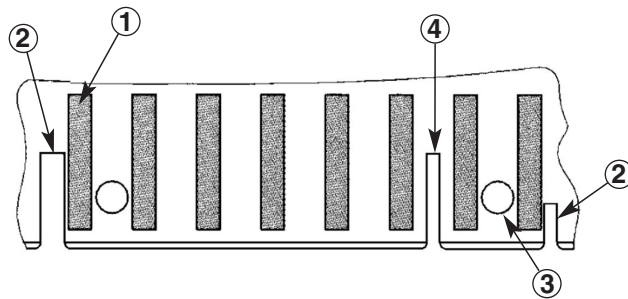





PCB Connector System (continued)

AMP MONO-SHAPE MARK II PCB Connector System

No. of Positions	Colour Marking as Shipped	RAST 5 Version	Part Numbers			Packaging Unit
			Standard	UL94V0	Glow Wire 750° no flame	
2	Green		0-284482-1	1-284482-1	3-284482-1	5500
2	Black		0-284482-2	1-284482-2	3-284482-2	5500
2	Violet		0-284482-3	1-284482-3	3-284482-3	5500
2	Orange		0-284482-4	1-284482-4	3-284482-4	5500
2	Grey		0-284482-5	1-284482-5	3-284482-5	5500
2	Red		0-28482-6	1-284482-6	3-284482-6	5500
3	Green		0-284483-1	1-284483-1	3-284483-1	3520
3	Black		0-284483-2	1-284483-2	3-284483-2	3520
3	Violet		0-284483-3	1-284483-3	3-284483-3	3520
3	Orange		0-284483-4	1-284483-4	3-284483-4	3520
4	Green		0-284484-1	1-284484-1	3-284484-1	2640

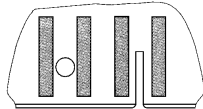
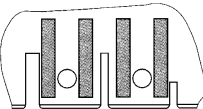
PCB Connector System (continued)

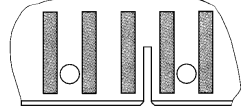
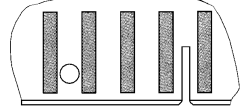
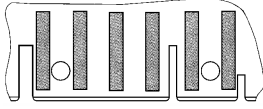
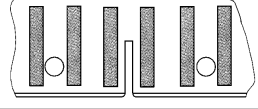
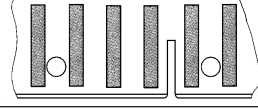
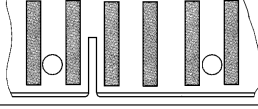
AMP MONO-SHAPE MARK II PCB Connector System



No. of Positions	Colour Marking as Shipped	RAST 5 Version	Part Numbers			Packaging Unit
			Standard	UL94V0	Glow Wire 750° no flame	
4	Black		0-284484-2	1-284484-2	3-284484-2	2640
4	Violet		0-284484-3	1-284484-3	3-284484-3	2640
5	Green		0-284485-1	1-284485-1	3-284485-1	2200
5	Black		0-284485-2	1-284485-2	3-284485-2	2200
5	Violet		0-284485-3	1-284485-3	3-284485-3	2200
5	Orange		0-28485-4	1-284485-4	3-284485-4	2200
6	Green		0-284486-1	1-284486-1	3-284486-1	1760
6	Black		0-284486-2	1-284486-2	3-284486-2	1760
6	Violet		0-284486-3	1-284486-3	3-284486-3	1760
6	Orange		0-284486-4	1-284486-4	3-284486-4	1760
6	Grey		0-284486-5	1-284486-5	3-284486-5	1760

2

Rast 5

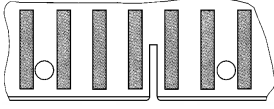
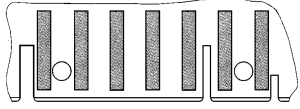
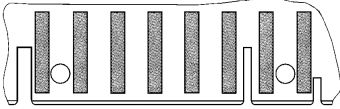
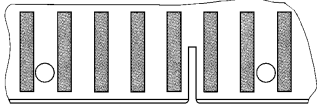
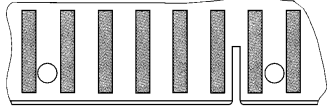
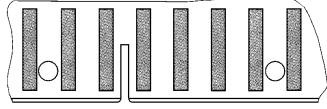
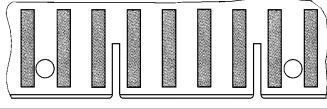
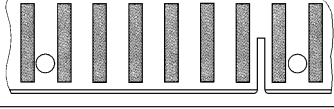

PCB Connector System (continued)

AMP MONO-SHAPE MARK II PCB Connector System

No. of Positions	Colour Marking as Shipped	RAST 5 Version	Part Numbers			Packaging Unit
			Standard	UL94V0	Glow Wire 750° no flame	
7	Green		0-284487-1	1-284487-1	3-284487-1	1540
7	Black		0-284487-2	1-284487-2	3-284487-2	1540
7	Violet		0-284487-3	1-284487-3	3-284487-3	1540
8	Green		0-284488-1	1-284488-1	3-284488-1	1320
8	Black		0-284488-2	1-284488-2	3-284488-2	1320
8	Violet		0-28488-3	1-284488-3	3-284488-3	1320
8	Orange		0-284488-4	1-284488-4	3-284488-4	1320
9	Green		0-284489-1	1-284489-1	3-284489-1	1100
9	Black		0-284489-2	1-284489-2	3-284489-2	1100
9	Violet		0-284489-3	1-284489-3	3-284489-3	1100
9	Orange		0-284489-4	1-284489-4	3-284489-4	1100

PCB Connector System (continued)

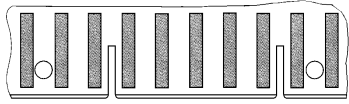
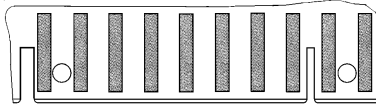
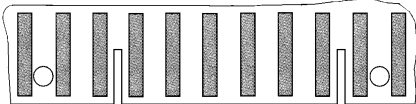
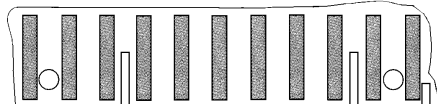
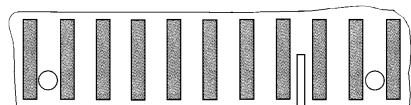
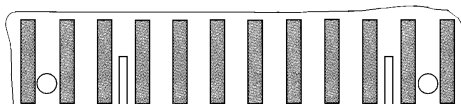
AMP MONO-SHAPE MARK II PCB Connector System

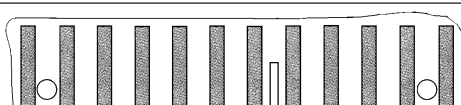
No. of Positions	Colour Marking as Shipped	RAST 5 Version	Part Numbers			Packaging Unit
			Standard	UL94V0	Glow Wire 750° no flame	
10	Green		0-284490-1	1-284490-1	3-284490-1	1100
10	Black		0-284490-2	1-284490-2	3-284490-2	1100
11	Green		0-284491-1	1-284491-1	3-284491-1	880
11	Black		0-284491-2	1-284491-2	3-284491-2	880
11	Violet		0-284491-3	1-284491-3	3-284491-3	880
12	Green		0-284492-1	1-284492-1	3-284492-1	880
12	Black		0-284492-2	1-284492-2	3-284492-2	880
12	Violet		0-284492-3	1-284492-3	3-284492-3	880

2

Rast 5

Application Tooling

Entry Level Semi-Automatic IDC Bench Machines

SIM 500P

Part No. 528376-2

SIM 500T

Part No. 528377-2

In the Entry Level concept, the application process is shared by two different semi-automatic machines.

The SIM 500P prepares the AMP multifitting Mark II banded IDC connectors. The machine removes the connector from the chain and cuts the keying ribs.

Next, the prepared IDC connectors are applied by the SIM 500T.

To facilitate this, the individual IDC connectors are loaded into a nest and moved automatically into the termination station.

The manually inserted wires are, according to a program,

terminated into the appropriate insulation displacement slots. The cover is then separated from the housing, turned and pushed into final position.

The nest, including the finished harness module, is removed from the easily accessed track.



SIM 500P

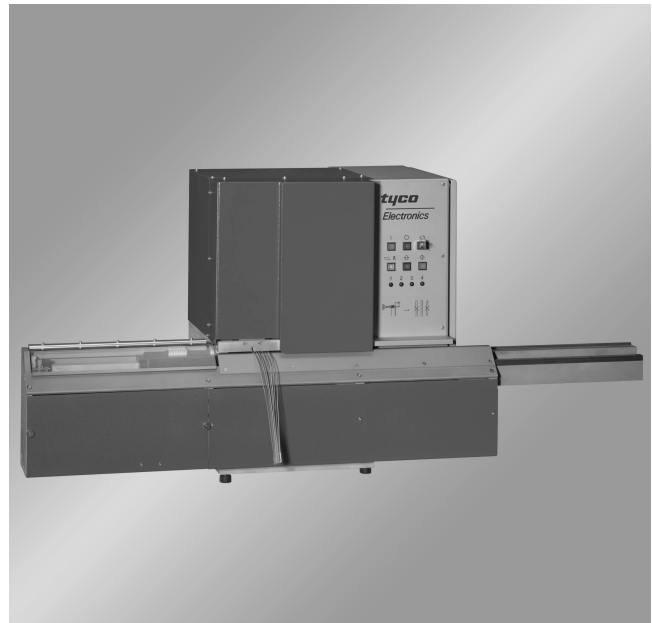

SIM 500T

Technical Features

- Processing of all versions of the AMP multifitting Mark II connector system with only minor set up changes.
- Cutting and reliable removal of the reel clips.
- Cutting and reliable removal of the coding and polarisation ribs by means of a preset cutting block.
- Nest capacity per machine cycle
 - one connector 4- to 8-pos.
 - two connectors 2- and 3-pos.
 - four connectors 1-position
- Integrated monitoring of the connector supply.
- Simple operator interface.

Technical Data

Power Supply:
230 V AC, 50 Hz

Air Pressure:
6 bar

Cycle Time:
approx. 4 s / connector package
(without handling time)

Technical Features

- Application of all versions of the AMP multifitting Mark II connector, with only minor set up changes.
- Termination of the wire with active support of the IDC contact.
- Termination of two wires (double wire termination) programmable.
- Connector fixture, incorporating three nests for max. 12 positions each.
- Accessible and easily interchangeable mechanical program rail.
- By utilising several connector fixtures and program rails, output and set up times can be optimised.
- Simple operator interface.

Technical Data

Power Supply:
230 V AC, 50 Hz

Air Pressure:
6 bar

Cycle Time:
approx. 1.2 s / line
(without handling time)

Application Tooling (continued)

IDC Workstation – SIM 50

This semi-automatic machine was designed for the sequential processing of AMP multifitting Mark II IDC connector system and its variations such as direct and indirect mating connector with interior or exterior locking.

A processing sequence can consist of one or more IDC connectors of the same or different numbers of positions, but a maximum total of 12 positions.

The specific key coding of the connectors is performed during the termination process by an integrated cutting device.

The wires are manually fed into the machine and then automatically terminated.

Integrated control tests ensure a high quality product.



2

Rast 5

Technical Features

- Processing of all versions of the AMP multifitting Mark II connector system without additional set up time.
- Termination of the wire with active support of the IDC contact.
- Termination of two wires in the same slot is programmable.
- Colour coding on the connector cover possible.
- Wire exit angle can be bent 180°.
- Short set up and change-over times.
- High output.
- Correct wire insertion length and key codings are continually checked.
- Good / bad sorter; faulty connections will be destroyed.

Technical Data

- Power Supply:**
230 V AC, 50 Hz
- Air Pressure:**
6 bar
- Wire Size Range:**
0.35 mm² up to 1.5 mm²
- Insulation Diameter Range:**
1.2 mm up to 3.0 mm
- Wire Type:**
Stranded conductors

- 50 different production programs can be stored.
- Operator PC interface displaying machine status and production data; different languages available.
- Low maintenance costs and the capability of off-site troubleshooting via modem.
- Ergonomic and easy to operate through a Touch Screen Display.

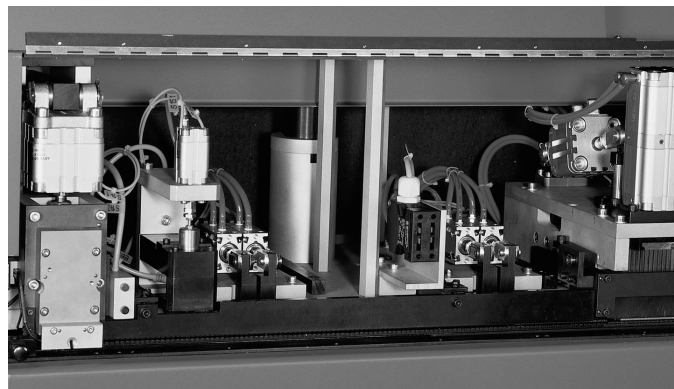

Processing Modules of the SIM 50

Application Tooling (continued)

Flexible Harness Maker – FHM

The FHM is a fully-automatic machine featuring modular set up. It is built to manufacture harnesses by processing both IDC connectors and crimp terminals.

The basic machine includes a 12 wire selector, a station that cuts the wires to length, a stripping station, a double-crimp unit, two crimping presses and wire end ejector for doubling and daisy chains.

A gripper unit takes the wire from the base machine and transfers it to the attached IDC station. Sequential processing allows the manufacturing of cross-overs and bridges as well as double-crimps, depending on the type of IDC connector used.

The IDC workstations are easily reconfigured for processing our different IDC connector systems. They include all the necessary processing operations for IDC termination with minimum change-over and set up times.

Quality checks integrated in the manufacturing process ensure the highest quality harness for every production run.



Technical Features

- Manufacturing of harnesses with 2.5 mm pitch IDC connectors and/or 5.0 mm pitch IDC connectors and/or with crimp terminals.
- IDC Workstations are available for the following connector systems:
 - AMP DUOPLUG 2.5
 - AMP DUOPLUG 2.5 Mark II
 - AMP DUOPLUG Power
 - AMP multifitting Mark II
 - AMP MONO-SHAPE Mark II
- The IDC Workstations can also be used as separate semi-automatic machines with manual wire transfer.
- The specific key coding of the IDC connector is done on the IDC Workstation.
- Integrated test equipment checks the coding and the insertion depth of the wire, and performs a continuity test. A spark testing unit is also available as an option.
- Wire printing and single housing insertion possible.
- Operator PC interface displays machine status and production data; different languages available.
- Low maintenance costs and the capability of off-site troubleshooting via modem.
- Ergonomic and easy to operate through a Touch Screen Display.

Technical Data

- Power Supply:**
400 V AC, 50 Hz
- Air Pressure:**
6 bar
- Wire Size Range:**
0.22 mm² up to 1.5 mm²
- Wire Length:**
220 mm up to 2,500 mm
- Insulation Diameter Range:**
1.2 mm up to 3.0 mm
- Wire Type:**
Stranded conductors

Application Tooling (continued)

IDC Harness Maker – IHM Mark III

The new IHM Mark III is a very high performance, fully-automatic machine designed to manufacture parallel jumper harnesses using IDC technology.

The simultaneous feeding of up to 21 wires guarantees high productivity and flexibility and a choice of 2.5 mm or 5.0 mm pitch IDC systems.

The gripper unit on the left side of the machine is able to spread the wires in both directions to enable the production of harnesses using both 2.5 mm and 5.0 mm pitch connectors at the same time.

Available options are a stripper crimper unit with an integrated crimp force analyser and a good/bad sorting unit.

The IDC workstations are easily reconfigured for processing our different IDC connector systems. They include all the necessary processing operations for IDC termination with minimum change-over and set up times.

Quality checks integrated in the manufacturing process ensure the highest quality harness for every production run.

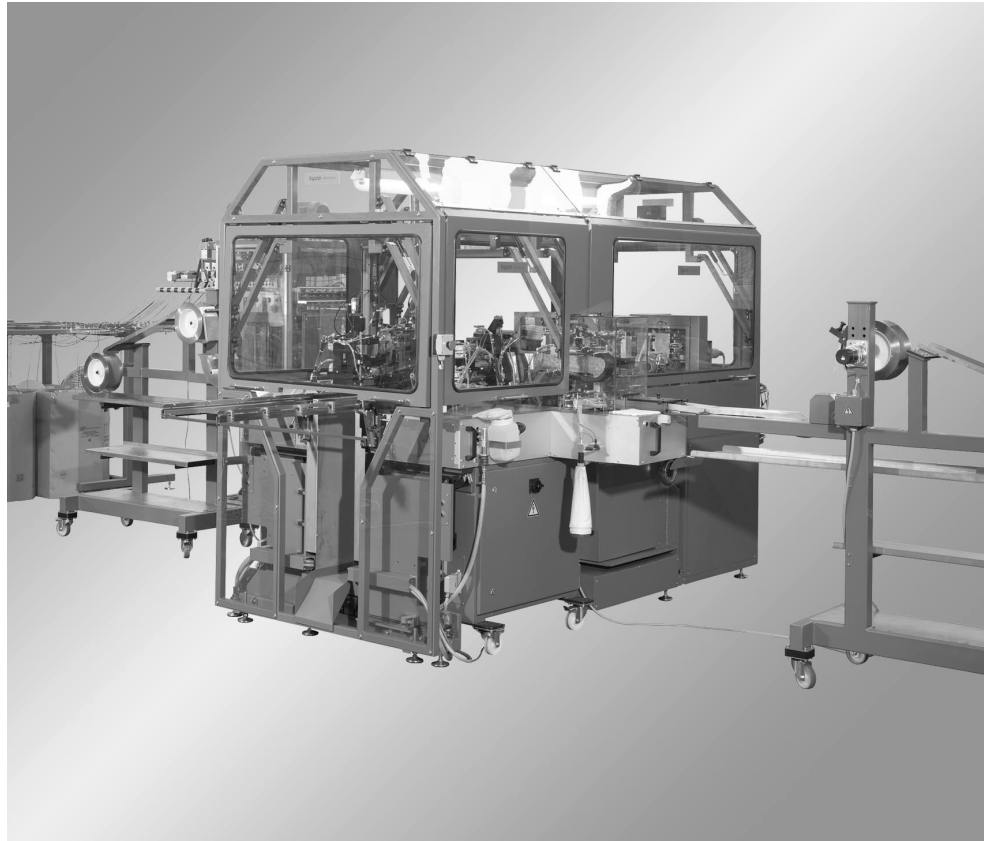

Technical Features

- Manufacturing of harnesses using 2.5 mm and/or 5.0 mm pitch IDC systems.
- Very short wire length is possible.
- Option available to produce harnesses with crimp terminals on one side.
- IDC Workstations are available for the following connector systems:
 - AMP DUOPLUG 2.5
 - AMP DUOPLUG 2.5 Mark II
 - AMP DUOPLUG Power
 - AMP multifitting Mark II
 - AMP MONO-SHAPE Mark II
 - AMP MT Edge
- The specific key coding of the IDC connector is done on the IDC Workstation.
- Integrated test equipment checks the coding and the insertion depth of the wire, and performs a continuity test. A spark testing unit is also available as an option.
- Operator PC interface displays machine status and production data; different languages available.
- Low maintenance costs and the capability of off-site troubleshooting via modem.
- Ergonomic and easy to operate through a Touch Screen Display.

Technical Data

- Power Supply:**
400 V AC, 50 Hz
- Air Pressure:**
6 bar
- Wire Size Range:**
0.22 mm² up to 1.5 mm²
- Wire Length:**
125 mm up to 2,200 mm
- Insulation Diameter Range:**
1.2 mm up to 3.0 mm
- Wire Type:**
Stranded conductors

Introduction

AMP Standard Timer Connectors in In-Line Mating Technology

AMP Standard Timer connectors according to RAST 5.0 mm standard have been developed to connect RAST 5 components (like motors, leach pumps, water level regulators, relays and push-button switches) in the Household Appliances Industry.

They meet industry requirements, for example multiple position connectors, secure connection even at inclining mating as well as a sturdy contact design.

AMP Standard Power Timer contacts, for use with Standard Timer housings, are suitable for high density and high current capacity up to 16 A.

Housing is designed for end-to-end stacking without contact loss. They are available in different keying and locking versions from 2- positions to 12-positions.

Standard Timer contacts can be used with stranded wires from 0.5 mm² to 2.5 mm² and can be double terminated. Of course, the corresponding tooling is available, too.

AMP Standard Timer connectors are tested by VDE and fulfil all requirements acc. to VDE 0700 (air gap, creepage distance, glow wire test, ball pressure test, creepage current strength).

UL recognised component.

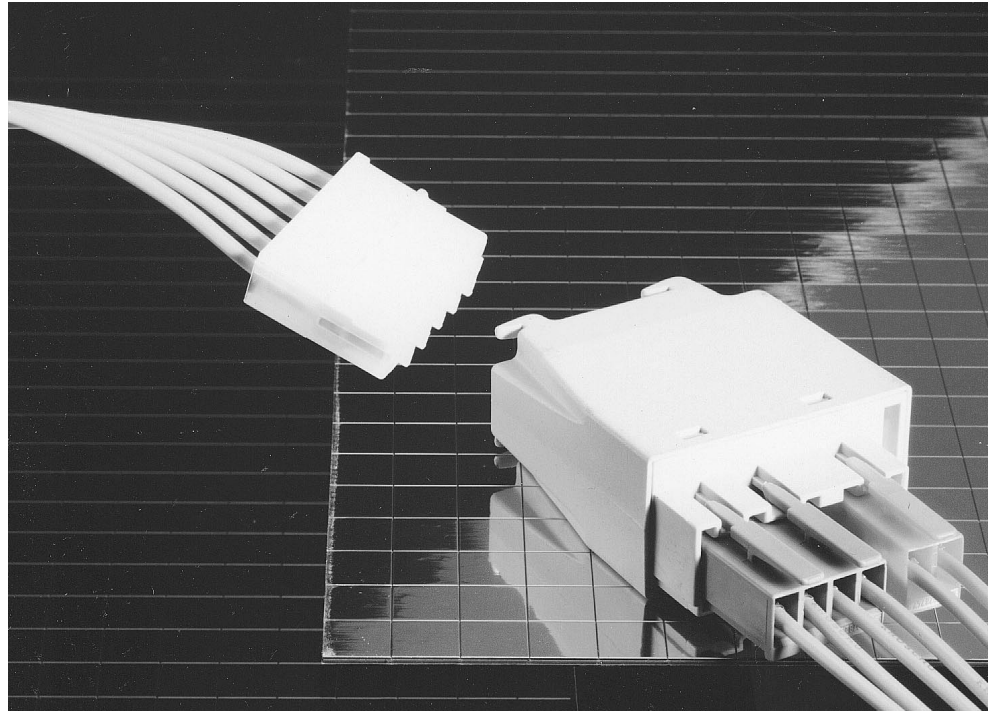

Technical Features

Centerline:
5.0 mm

Available Number of Positions:
2- to 12-positions

Housing Material:
Polyamide PA 6.6

Contact Material:
CuSn, CuFe

Contact Finish:
Tin Plated, Silver Plated

Wire Size Range:
from 0.5 to 2.5mm²

Wire Size Diameter:
from 2.0 to 3.3mm

Temperature Range:
-40°C to +110°C

Current Voltage:
220 V_~

Current Rating:
max. 16 A
Standard Timer: 6 A
Power Timer: 16 A

Mating Force Contact:
≤ 15 N

Unmating Force:
≤ 8 N

Air and Creepage Distance:
≥ 3.0mm

Track Resistance:
PTI 250

Glow Wire Test:
850°C

Contacts made for Tabs according:-
DIN 46244
(6.3 x 0.8mm / 4.8 x 0.8mm)
DIN 46343 Part 2 and 3

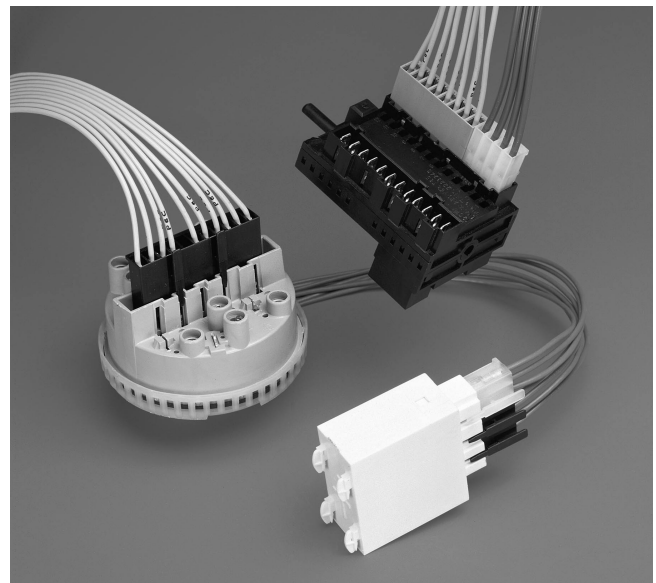

Interior and Exterior Locking

Interior Locking

Connection to the Components according RAST 5 Standard

- 1 Connected Timer Contact
- 2 Standard Timer Housing with Interior Locking
- 3 Keying
- 4 Polarisation
- 5 Locking Latch
- 6 Cover (Secondary Locking)
- 7 RAST 5 Tab Array

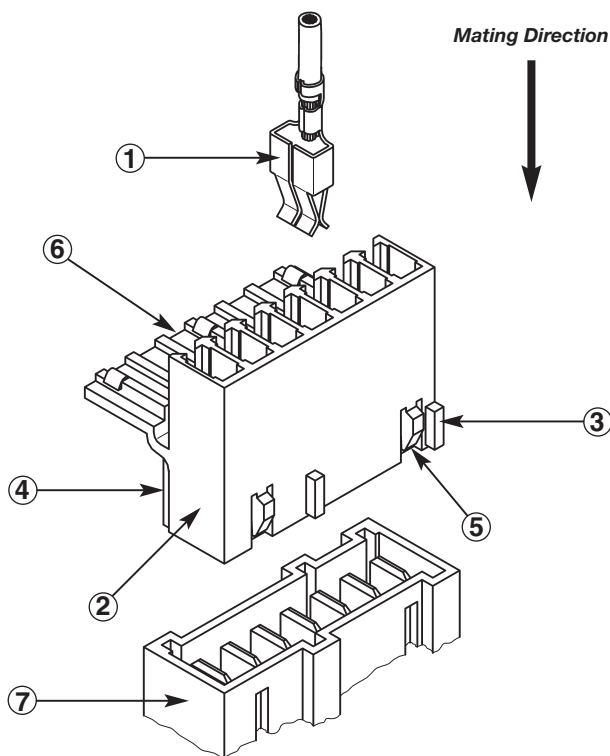

Exterior Locking

Connection to the Components according RAST 5 Standard

- 1 Connected Timer Contact
- 2 Standard Timer Housing with Exterior Locking
- 3 Keying
- 4 Polarisation
- 5 Locking Latch
- 6 RAST 5 Tab Array

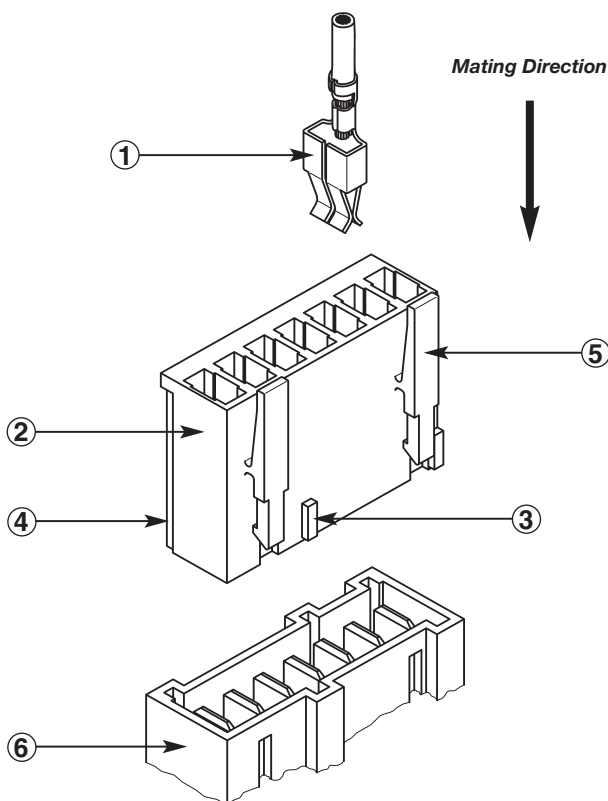

2

Rast 5

Keying Plan and Housings

Keying Plan from Mating Direction

- 1 Locking Latch
- 2 Keying Rib
- 3 Keying Rib between Cavity
- 4 Slanted Keying Rib
- 5 Polarisation Rib
- 6 Cavity Number

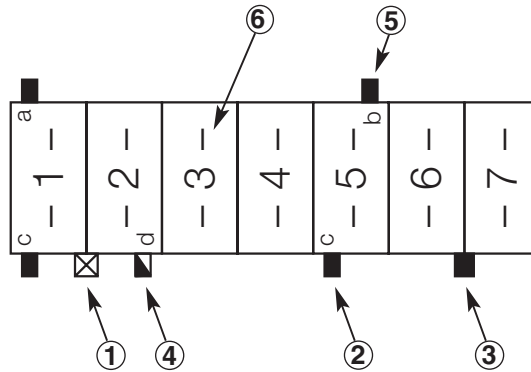

AMP Standard Timer Housings 2 Position Rast 5 Variations

Keying Version Colour	RAST 5 Version	Part Numbers		Packaging Unit
		with Interior Locking	with Exterior Locking	
02-A Natural		928344-2	6-928247-2	2.500 / 2.500
02-B Black		2-928344-2	928247-2	2.500 / 3.000
02-C Grey		3-964951-2	8-928247-2	2.500 / 2.500
02-D Blue		—	964983-2	2.500
02-E Green		6-928344-2	5-928247-2	2.500 / 2.500
02-G Violet		5-928344-2	2-964983-2	2.500 / 2.500
02-H Brown		3-928344-2	—	2.500
02-I Orange		2-964951-2	3-928247-2	2.500 / 2.500

Bold Part Numbers are Preferred Types

Housings

AMP Standard Timer Housings 2 Position Rast 5 Variations (continued)

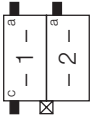
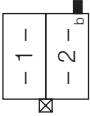
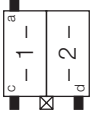
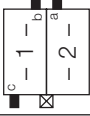
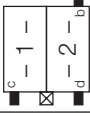
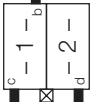
Keying Version Colour	RAST 5 Version	Part Numbers		Packaging Unit
		with Interior Locking	with Exterior Locking	
02-K Yellow-Green		—	4-928247-2	2.500
02-L Natural		928343-2	—	3.000
02-M Ultramarine-Blue		—	3-964983-2	2.500
02-O Pink		964951-2	2-928247-2	2.500 / 2.500
02-P Purple		—	7-928247-2	2.500
02-Q Turquoise		4-928344-2	—	2.500

Bold Part Numbers are Preferred Types

AMP Standard Timer Housings 2 Position Special Variations

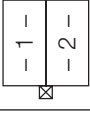
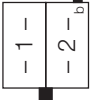
Colour	Version	Part Numbers		Packaging Unit
		with Interior Locking	with Exterior Locking	
Natural		7-927740-2	9-928247-2	5.000
Natural		964768-1	—	5.000

2
Rast 5

Housings

AMP Standard Timer Housings 3 Position Rast 5 Variations

Keying Version Colour	RAST 5 Version	Part Numbers		Packaging Unit
		with Interior Locking	with Exterior Locking	
03-A Natural		928344-3	—	3.000
03-B Black		—	964983-3	2.500
03-D Blue		—	3-928247-3	2.500
03-G Violet		—	2-928247-3	2.500
03-H Brown		—	4-928247-3	2.500
03-K Yellow-Green		—	2-964983-3	2.500

Bold Part Numbers are Preferred Types

Housings

AMP Standard Timer Housings 3 Position Special Variations

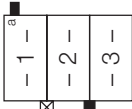
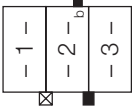
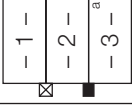
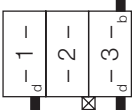
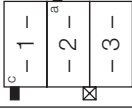
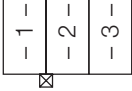
Colour	Version	Part Numbers		Packaging Unit
		with Interior Locking	with Exterior Locking	
Natural		928343-3	—	3.000
Black		2-928343-3	—	3.000
Grey		3-928343-3	—	3.000
Yellow		—	928247-3	2.000
Grey		2-928344-3	—	2.500
Natural		—	5-928247-3	2.500

Bold Part Numbers are Preferred Types

Housings

AMP Standard Timer Housings 4 Position Rast 5 Variations

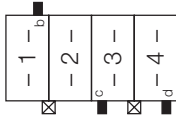
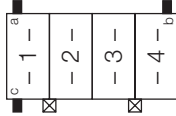
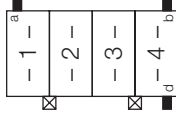
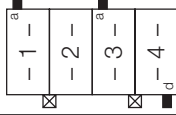
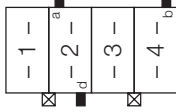
Keying Version Colour	RAST 5 Version	Part Numbers		Packaging Unit
		with Interior Locking	with Exterior Locking	
04-A Natural		928344-4	4-928247-4	2.000 / 1.250
04-B Black		—	5-928247-4	1.250
04-C Grey		3-928344-4	928247-4	2.000 / 1.250
04-F White		—	2-928247-4	1.250
03-G Violet		—	3-928247-4	1.250

AMP Standard Timer Housings 4 Position Special Variations

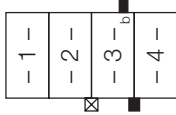
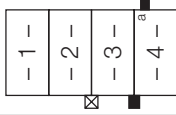
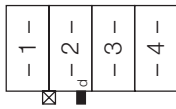
Colour	Version	Part Numbers		Packaging Unit
		with Interior Locking	with Exterior Locking	
Natural		928343-4	—	2.500
Black		2-928343-4	—	2.500
Black		3-928344-4	—	2.500

Bold Part Numbers are Preferred Types

Housings

AMP Standard Timer Housings 5 Position Rast 5 Variations

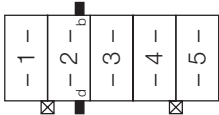
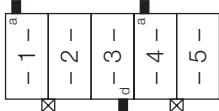
Keying Version Colour	RAST 5 Version	Part Numbers		Packaging Unit
		with Interior Locking	with Exterior Locking	
05-B Black		—	2-928247-5	1.000
05-D Blue		—	3-928247-5	1.000

AMP Standard Timer Housings 5 Position Special Variations

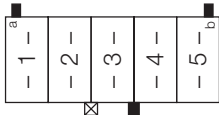
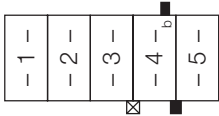
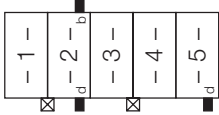
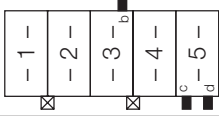
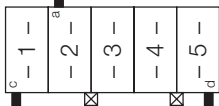
Colour	Version	Part Numbers		Packaging Unit
		with Interior Locking	with Exterior Locking	
Natural		928343-5	—	1.000
Black		2-928343-5	—	1.000
Green		—	5-928247-5	1.250
Yellow		—	4-928247-5	1.250
Natural		—	6-928247-5	1.250

Bold Part Numbers are Preferred Types

Housings

AMP Standard Timer Housings 6 Position Rast 5 Variations

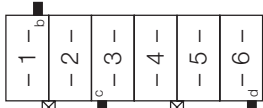
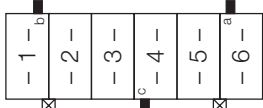
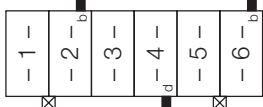
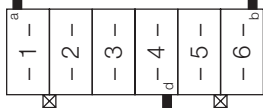
Keying Version Colour	RAST 5 Version	Part Numbers		Packaging Unit
		with Interior Locking	with Exterior Locking	
06-A Natural		—	964983-6	2.500
06-C Grey		—	928247-6	1.000
06-D Blue		—	2-928247-6	1.000
06-E Green		—	3-928247-6	1.000

Bold Part Numbers are Preferred Types

Housings

AMP Standard Timer Housings 6 Position Special Variations

Colour	Version	Part Numbers		Packaging Unit
		with Interior Locking	with Exterior Locking	
Natural		928343-6	—	1.000
Black		2-928343-6	—	1.000
Natural		928151-6	—	1.500
Beige		—	7-928247-6	1.000
Yellow		—	4-928247-6	1.000
Brown		—	5-928247-6	1.000
Natural		—	6-928247-6	1.000
Natural		2-928344-6	—	1.500
Green		3-928344-6	—	1.500



Bold Part Numbers are Preferred Types

Housings

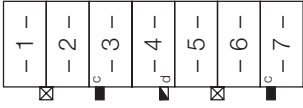
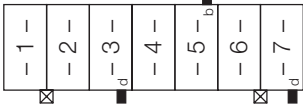
AMP Standard Timer Housings 7 Position Rast 5 Variations

Keying Version Colour	RAST 5 Version	Part Numbers		Packaging Unit
		with Interior Locking	with Exterior Locking	
07-A/S Natural		928151-7	—	1.300
07-C Grey		—	928247-7	700

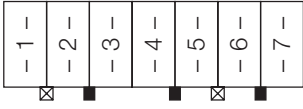
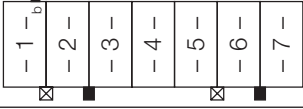
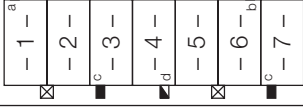
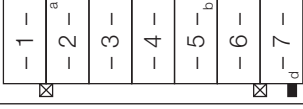
AMP Standard Timer Housings 7 Position Special Variations

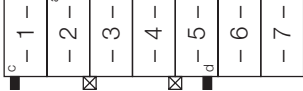
Colour	Version	Part Numbers		Packaging Unit
		with Interior Locking	with Exterior Locking	
Natural		928343-7	—	500
Black		2-928343-7	—	500
Natural		928344-7	—	500
Blue		—	2-928247-7	800
		2-928151-7 Green	4-928247-7 Natural	1.300 / 1.000
Natural		—	5-928247-7	1.000
Natural		—	6-928247-7	1.000

Bold Part Numbers are Preferred Types

Housings

AMP Standard Timer Housings 8 Position Rast 5 Variations

Keying Version Colour	RAST 5 Version	Part Numbers		Packaging Unit
		with Interior Locking	with Exterior Locking	
08-D Blue		—	928247-8	800

AMP Standard Timer Housings 8 Position Special Variations

Colour	Version	Part Numbers		Packaging Unit
		with Interior Locking	with Exterior Locking	
Natural		928343-8	—	1.000
Black		2-928343-8	—	1.000
Grey		3-928343-8	—	1.000
Natural		—	2-928247-7	800

Bold Part Numbers are Preferred Types

2
Rast 5

Housings

AMP Standard Timer Housings 9 Position Rast 5 Variations

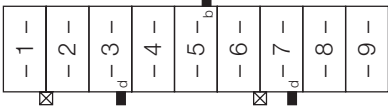
Keying Version Colour	RAST 5 Version	Part Numbers		Packaging Unit
		with Interior Locking	with Exterior Locking	
09-D Blue		—	2-928247-9	600

AMP Standard Timer Housings 9 Position Special Variations

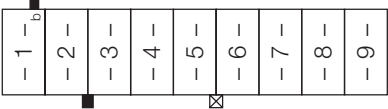
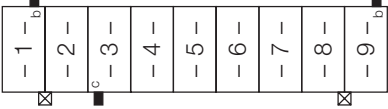
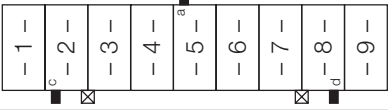
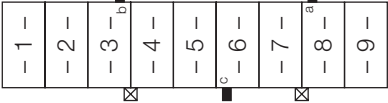
Colour	Version	Part Numbers		Packaging Unit
		with Interior Locking	with Exterior Locking	
Natural		927740-9	—	1.000
Natural		928151-9	—	1.000
Yellow		—	928247-9	500
Brown		—	3-928247-9	600

Bold Part Numbers are Preferred Types

Housings

AMP Standard Timer Housings 10 Position Special Variations

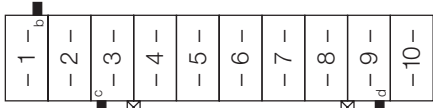
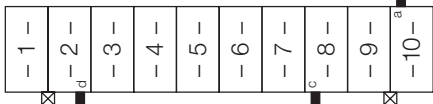
Keying Version Colour	RAST 5 Version	Part Numbers		Packaging Unit
		with Interior Locking	with Exterior Locking	
Brown		—	1-928247-0	1.400
Grey		—	2-928247-0	500

AMP Standard Timer Housings 11 Position Rast 5 Variations

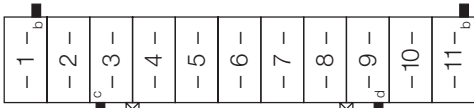
Keying Version Colour	RAST 5 Version	Part Numbers		Packaging Unit
		with Interior Locking	with Exterior Locking	
11-B Black		—	1-928247-1 Yellow	1.000

AMP Standard Timer Housings 11 Position Special Variations

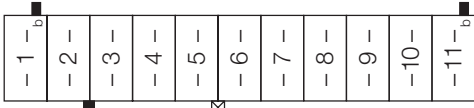
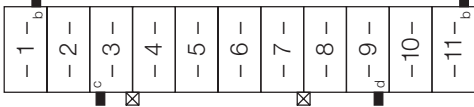
Colour	Version	Part Numbers		Packaging Unit
		with Interior Locking	with Exterior Locking	
Natural		1-927740-1	—	800
Blue		—	2-928247-1	1.000

AMP Standard Timer Housings 12 Position Special Variations

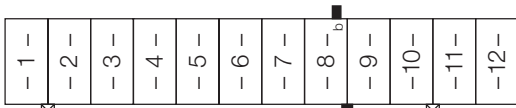
Colour	Version	Part Numbers		Packaging Unit
		with Interior Locking	with Exterior Locking	
Natural		1-927740-2	—	700

Bold Part Numbers are Preferred Types

Standard Timer Connector and Contacts

Technical Data

Material:

Brass, Tin Plated

Mating Part:

6.3 Tab

Wire:

FLK 0.5/0.75 and 1.5mm²

Current Carrying Capacity to 6A:

- 1 = Wire 0.50mm², 11pos. housing
- 2 = Wire 0.75mm², 11pos. housing
- 3 = Wire 0.50mm², 2pos. housing
- 4 = Wire 0.75mm², 2pos. housing

Current Carrying Capacity to 16A:

- 5 = Wire 1.50mm², 11pos. housing
- 6 = Wire 1.50mm², 2pos. housing

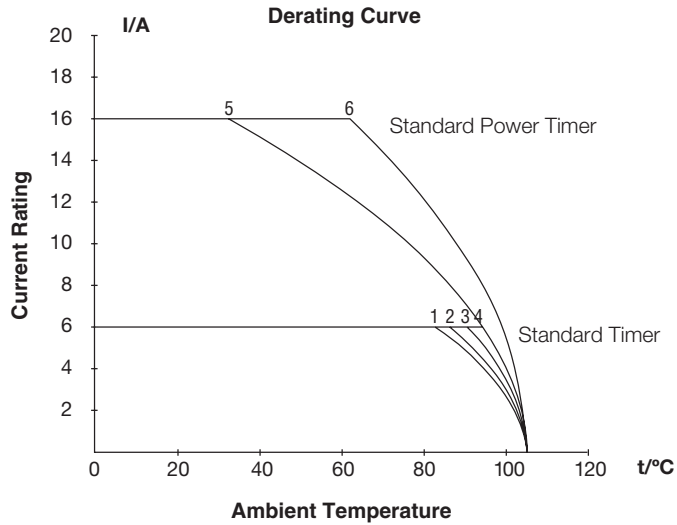

Standard Timer Contacts with One Locking Lance

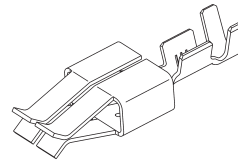

Wire Size Range (mm ²)	Insulation Diameter Range (mm)	Material	Finish	Part Number	Packaging Unit
0.5–1.0	1.4–2.3	CuZn/Brass	Tin Plated	928820-1	3.000
1.0–2.5	3.0–4.3	CuZn/Brass	Tin Plated	926973-1	2.500

Standard Timer Contacts with Two Locking Lances

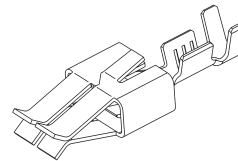

Wire Size Range (mm ²)	Insulation Diameter Range (mm)	Material	Finish	Part Number	Packaging Unit
0.5–1.0	1.4–2.3	CuZn/Brass	Tin Plated	964201-1	3.000
1.0–2.5	3.0–4.3	CuZn/Brass	Tin Plated	964202-1	2.000

Standard Power Timer

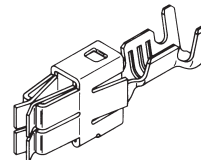

Wire Size Range (mm ²)	Insulation Diameter Range (mm)	Material	Finish	Part Number	Packaging Unit
1.0–2.5	2.2–3.0	CuFe/Copper Iron	Tin Plated	964203-1	2.300
1.0–2.5	2.2–3.0	CuFe/Copper Iron	Silver Plated	964203-5	2.300
1.5–3.0	max. 2 x 3.0	CuFe/Copper Iron	Tin Plated	964204-1	2.000
1.5–3.0	max. 2 x 3.0	CuFe/Copper Iron	Silver Plated	964204-5	2.000

Bold Part Numbers are Preferred Types

Engineering Notes



Engineering Notes



X-ON Electronics

Largest Supplier of Electrical and Electronic Components

Click to view similar products for [Headers & Wire Housings](#) category:

Click to view products by [TE Connectivity](#) manufacturer:

Other Similar products are found below :

[95000-104TRLF](#) [10135584-644402LF](#) [DF62W-EP2022PCA](#) [95000-106TRLF](#) [DF62W-2022SCA](#) [DF62W-EP2022PC](#) [2203348](#) [DF62W-2022SC](#) [1084018](#) [1029039](#) [1084017](#) [802-10-012-10-002000](#) [1112640](#) [1112639](#) [000-34000](#) [0009482033](#) [0009507031](#) [57102-S06-03LF](#) [57202-S52-04LF](#) [PCN6-15S-2.5E](#) [0039019024](#) [58102-G61-06LF](#) [582553-1](#) [0009485154](#) [0009508121](#) [0022285053](#) [0050291907](#) [018731A](#) [LY20-4P-DT1-P1E-BR](#) [02.125.8002.8](#) [60101931](#) [60598-1 \(Cut Strip\)](#) [M1625-3R/100](#) [61062-3](#) [61082-181009](#) [636-1427](#) [638009-1](#) [641938-9](#) [641991-4](#) [644168-1](#) [647662-1](#) [65039-019ELF](#) [65817-002LF](#) [65817-015LF](#) [65863-015LF](#) [66207-023LF](#) [67016-026LF](#) [67046-001LF](#) [67095-007LF](#) [67230-005LF](#)