

REMOTE INPUT/ OUTPUT TERMINAL SYSTEM (RITS) CONNECTORS

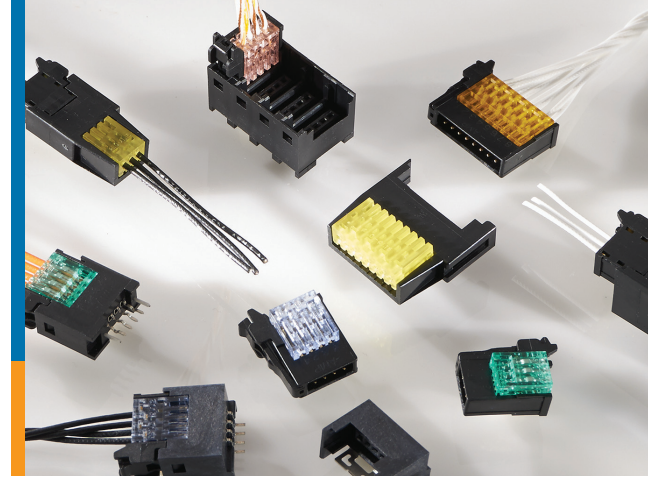

The e-CON standard was developed in Japan in 2001 by a group of Japanese manufacturers in order to standardize connections from sensors to terminals. This standard is not under control of any standard organizations. Without the standard, each manufacturer had specified different connectors for terminations of sensors to Programmable Logic Controllers (PLCs), and end users had to prepare many different connectors and different tools. In order to improve this situation and create a user-friendly environment, TE Connectivity has offered AMP RITS connectors as the standard interface connector for sensors. The 4-position RITS connector is approved as the industry standard connector.

Key Benefits

- Termination by generic tools
- Small 2.0 mm [.079] centerline connectors
- Two contact points structure provides for high contact reliability
- Housing colors indicate applicable wire range
- Component Recognized by UL to US and Canadian Standards, File No. E28476

Electrical

- **Current rating:** Max. 3 A
- **Voltage rating:** 32 V DC

Mechanical

- **Applicable wire range:** 0.1 to 0.5 mm² [27 to 20 AWG]
- **Outside Diameter:** 0.6 to 1.6 mm [.02 - .06]

Product Specifications

- **Product specification:** 108-5765
- **Instruction sheets:** 411-78014
411-78162

Materials

- **Housing:** PBT (UL 94V-0)/Polycarbonate (UL 94V-0)/
- **Contact:** Phosphor Bronze Platings - 0.2 μm [.000007] gold plated underplated 1.27 μm [.000050] Ni
- **LCP (SMT Products)**

Locking Configuration

The new locking lever design secures a wire-to-wire connection and can be pulled through a partially jammed wiring duct. When mated, a very clear click-sound will be heard. It will help prevent accidental half-mating.

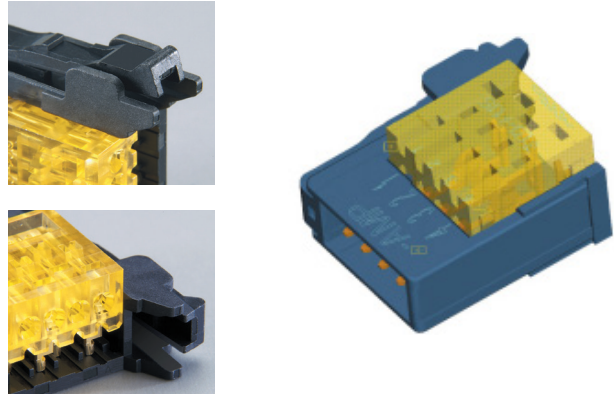

Chisel Press Contact

This new technology has three major features: Chisel, Press and Retention.

The chisel shaped contact pierces into wire to secure a much larger contact area. The press function will keep the contact pressure applied. The retention mechanism retains the wire at a higher retention force than Insulation Displacement Contact (IDC) connectors. Chisel Press Contact is the new wire termination technology to be applied to many kinds of wire from solid to multi-stranded commonly used in Factory Automation (FA) industries.

Cost Reduction

RITS Connectors offer 80% cost reduction of operation compared to conventional crimping connectors.

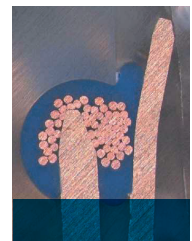
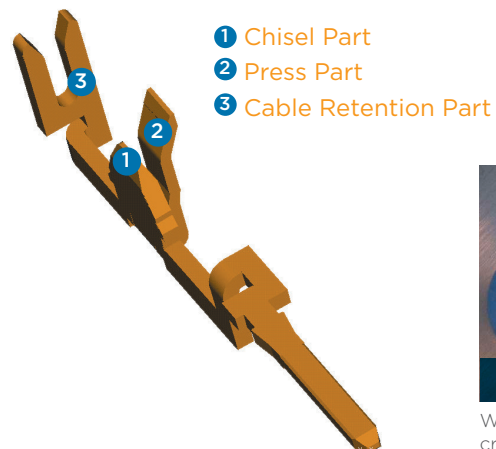
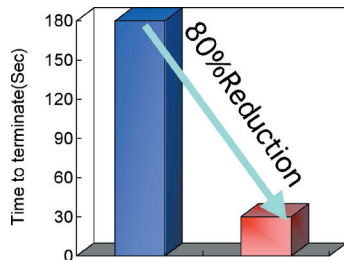

Wire termination cross section

RITS INTERCONNECTION SYSTEM CONNECTORS

Easy Termination

Easier terminations made with lower applied cost and improved quality.

In the manufacturing process of FA equipment, electrical connections by crimping are commonly seen in the assembly lines. RITS (Remote I/O Terminal System) connectors offer an easy and efficient connection method as well as total cost reduction with higher electrical reliability without special skill to perform the work.

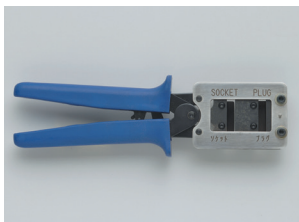

Part Number: 1729940-1

Instruction Sheet: 411-78162

Please refer to Instruction Sheet 411-78014 for further detail.

STEP 1

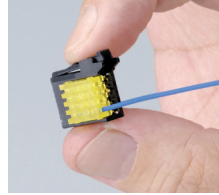

Insert each wire into Housing.

Pliers can only be used for 3- and 4-position RITS connectors.

STEP 2

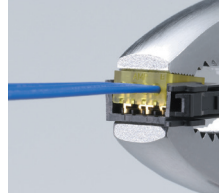



Squeeze housing together with pliers or press the housing together with a special tool.

Please use the special tool for larger than 5-position RITS connectors.

The way to connect wire is quite easy: Insert wire into a housing and pinch the housing with a generic tool such as pliers. TE Connectivity also provides a special tool for RITS termination at a more economical price than a crimp-type tool due to its simple function.

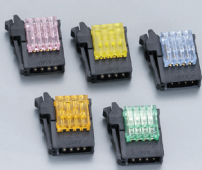
Product Features

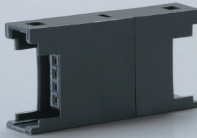
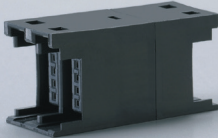
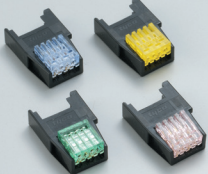
	PLUG Connectors	HDR Connectors	JCT Box		Socket Connectors
			(2D)	(4D)	
PRODUCTS					
FEATURES	<ul style="list-style-type: none"> • PLUG Connectors for wire termination • Consists of HOLD HSG and BODY HSG • HSG colors indicate applicable wire range 	<ul style="list-style-type: none"> • Connectors for PCB • Stackable mounting is possible • Single row and 4row types available • Right Angle type available with SMT Type • Prevent from miss-direction-inserting 	<ul style="list-style-type: none"> • For Junction Box. • Plugs can be mated on both sides • Panel type version also available 	<ul style="list-style-type: none"> • Basic same feature as 2D type • Four circuits are made common respectively. 	<ul style="list-style-type: none"> • Socket connectors for wire termination • Plug can be mated. • Hold housing color same as Plug connectors

RITS INTERCONNECTION SYSTEM CONNECTORS

Various Product Line-up









RITS connectors are available for wire-to-wire type and PCB mount type from 3- through 8-positions.

		PLUG Connectors					Header PCB Mount			Junction Box		Socket Connector				
Wire Range & O/S Diameter mm		0.6-0.9	0.9-1.0	1.0-1.15	1.15-1.35	1.35-1.6	Vertical		Horizontal	2D	4D	0.9-1.0	1.0-1.15	1.15-1.35	1.35-1.6	
HSG Color		Orange	Red	Yellow	Blue	Green	single row	4 row	single row			Red	Yellow	Blue	Green	
(POS)	3P	★	★	★	★	★	★	★	★	★	★	★	★	★	★	★
	4P*	★	★	★	★	★	★	★	★	★	★	★	★	★	★	★
	5P	★	★	★	★	★	★	-	-	-	-	-	-	-	-	-
	6P	★	★	★	★	★	★	-	-	★	-	★	★	★	★	★
	7P	★	★	★	★	★	★	-	-	-	-	-	-	-	-	-
	8P	★	★	★	★	★	★	-	-	★	-	★	★	★	★	★

- ★ Available
- No Plan
- * e-CON Conform

Applied cable

Applicable cable is designated by its outside diameter. Please choose the appropriate connector from the outside diameter of cable to be used with.

Wire Range (mm ² *)	0.1-0.5 mm ² [27-20 AWG]				
Outside Diameter	0.6 - 0.9 [.024 - .035]	0.9 - 1.0 [.035 - .039]	1.0 - 1.15 [.039 - .045]	1.15 - 1.35 [.045 - .053]	1.35 - 1.60 [.053 - .063]
Plug HSG Color					
Part Number	3-1473562-X	1-1473562-X	1473562-X	2-1473562-X	4-1473562-X
Socket HSG Color					
Part Number		1-1746741-X	1746741-X	2-1746741-X	4-1746741-X
Insulator Material	PVC/PE				

How to choose the appropriate connector

Please find the wire diameter in the above table and locate the appropriate connector part number. All wire needs to be tested for termination with the connector. Further detailed information is available from Technical Support.

*When 0.08 mm² [29 AWG] wire is to be used, please contact Technical Support.
Note: All part numbers are RoHS Compliant.

RITS INTERCONNECTION SYSTEM CONNECTORS

Plug Connectors

x-1473562-x
 -3 to -8 shows No. of Positions
 Shows wire range: Blank- Yellow,
 1- Red, 2- Blue, 3- Orange, 4- Green

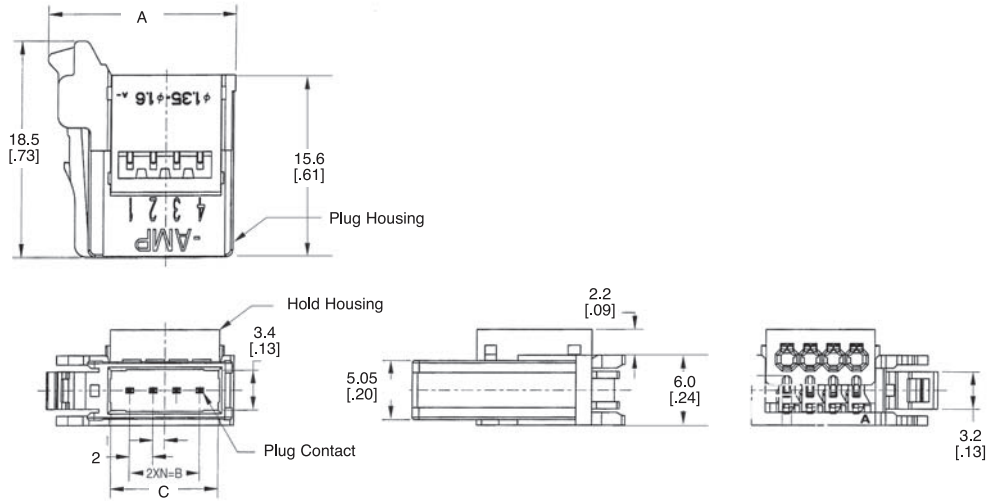

No. of Positions	Dimensions				Part Number				
	N	A	B	C	Hold Housing Color				
					Yellow	Red	Blue	Orange	Green
3	2 [.08]	14.1 [.56]	4 [.16]	7.2 [.28]	1473562-3	1-1473562-3	2-1473562-3	3-1473562-3	4-1473562-3
4	3 [.12]	16.1 [.63]	6 [.24]	9.2 [.36]	1473562-4	1-1473562-4	2-1473562-4	3-1473562-4	4-1473562-4
5*	5 [.20]	20.1 [.79]	10 [.39]	13.2 [.52]	1473562-5	1-1473562-5	2-1473562-5	3-1473562-5	4-1473562-5
6	5 [.20]	20.1 [.79]	10 [.39]	13.2 [.52]	1473562-6	1-1473562-6	2-1473562-6	3-1473562-6	4-1473562-6
7*	7 [.28]	24.1 [.95]	14 [.55]	17.2 [.68]	1473562-7	1-1473562-7	2-1473562-7	3-1473562-7	4-1473562-7
8	7 [.28]	24.1 [.95]	14 [.55]	17.2 [.68]	1473562-8	1-1473562-8	2-1473562-8	3-1473562-8	4-1473562-8

*The 5-position and the 7-position assemblies do not have contacts at the circuit number 6 and 8, respectively.
 Note: All part numbers are RoHS Compliant.

Socket Connectors

x-1746741-x
 -3 to -8 shows No. of Positions
 Shows wire range: Blank- Yellow,
 1- Red, 2- Blue, 4- Green

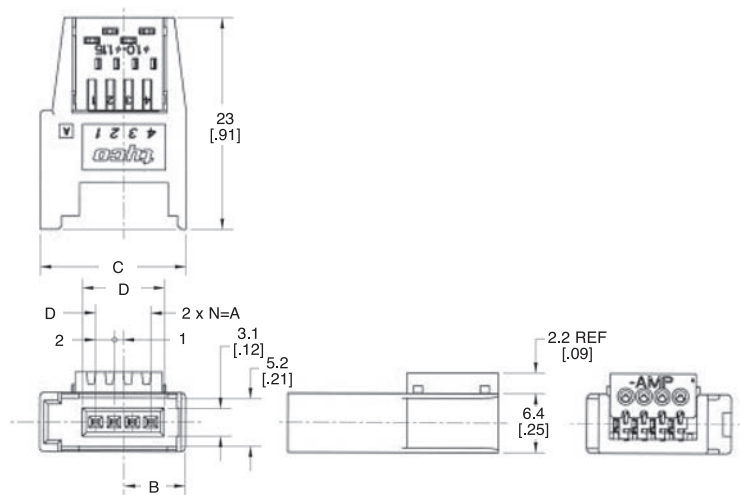

No. of Positions	Dimensions					Part Number			
	N	A	B	C	D	Hold Housing Color			
						Yellow	Red	Blue	Green
3	2 [.08]	4 [.16]	5.75 [.23]	13.8 [.54]	6.9 [.27]	1746741-3	1-1746741-3	2-1746741-3	4-1746741-3
4	3 [.12]	6 [.24]	6.75 [.27]	15.8 [.62]	8.9 [.35]	1746741-4	1-1746741-4	2-1746741-4	4-1746741-4
6	5 [.20]	10 [.39]	8.75 [.35]	19.8 [.78]	12.9 [.51]	1746741-6	1-1746741-6	2-1746741-6	4-1746741-6
8	7 [.28]	14 [.55]	10.75 [.42]	23.8 [.94]	16.9 [.67]	1746741-8	1-1746741-8	2-1746741-8	4-1746741-8

Note: All part numbers are RoHS Compliant.

Board Mount Headers 1-Row Vertical Type

1473565-x
-3 to -8 shows No. of Positions

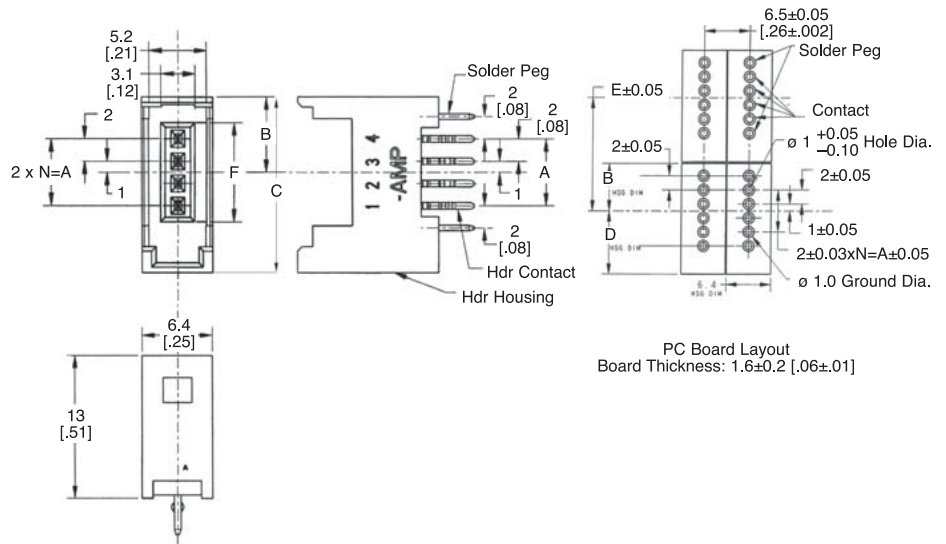

No. of Positions	Dimensions							Part Number
	N	A	B	C	D	E	F	
3	2 [.08]	4 [.16]	5.75 [.23]	13.8 [.54]	8.05 [.32]	14 [.55]	6.9 [.27]	1473565-3
4	3 [.12]	6 [.24]	6.75 [.27]	15.8 [.62]	9.05 [.36]	16 [.63]	8.9 [.35]	1473565-4
5*	5 [.20]	8 [.31]	8.75 [.35]	19.8 [.78]	11.05 [.44]	20 [.79]	12.9 [.51]	1473565-5
6	5 [.20]	10 [.39]	8.75 [.35]	19.8 [.78]	11.05 [.44]	20 [.79]	12.9 [.51]	1473565-6
7*	7 [.28]	12 [.47]	10.75 [.42]	23.8 [.94]	13.05 [.51]	24 [.94]	16.9 [.67]	1473565-7
8	7 [.28]	14 [.55]	10.75 [.42]	23.8 [.94]	13.05 [.51]	24 [.94]	16.9 [.67]	1473565-8

*The 5-position and the 7-position assemblies do not have contacts at the circuit number 6 and 8, respectively.
Note: All part numbers are RoHS Compliant.

Board Mount Headers 4-Row Vertical Type

1473567-x
-3 to -4 shows No. of Positions

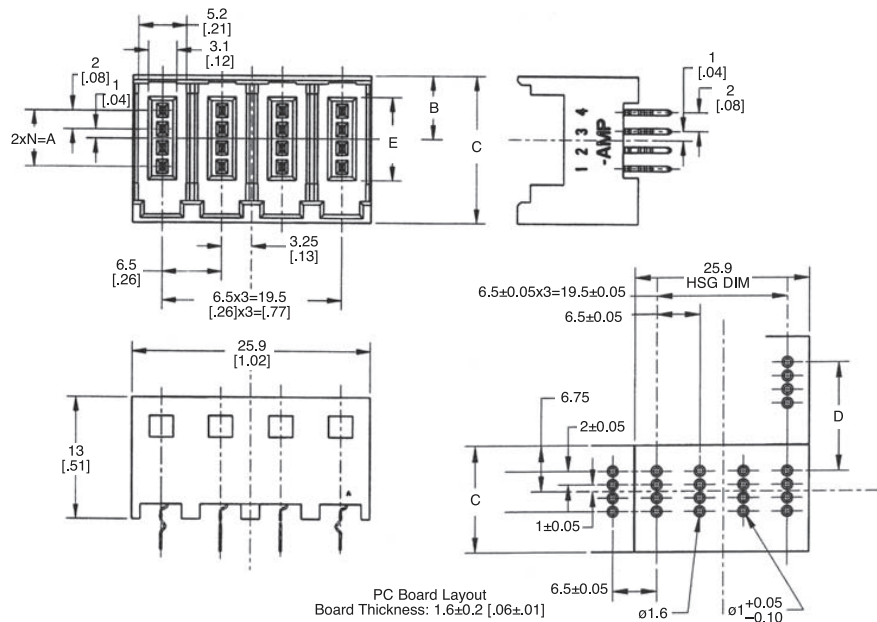

Drawing shows 4-position.
As to the 3-position, please confirm with the 3-position drawing.

No. of Positions	Dimensions							Part Number
	N	A	B	C	D	E		
3	2 [.08]	4 [.16]	5.75 [.23]	13.8 [.54]	14 [.55]	6.9 [.27]	1473567-3	
4	3 [.12]	6 [.24]	6.75 [.27]	15.8 [.62]	16 [.63]	8.9 [.35]	1473567-4	

Note: All part numbers are RoHS Compliant.

Board Mount Headers SMT Horizontal Type

x-1565994-x
 -3 to -4 shows No. of Positions
 Shows Boss availability: Blank- with Boss,
 1- without Boss

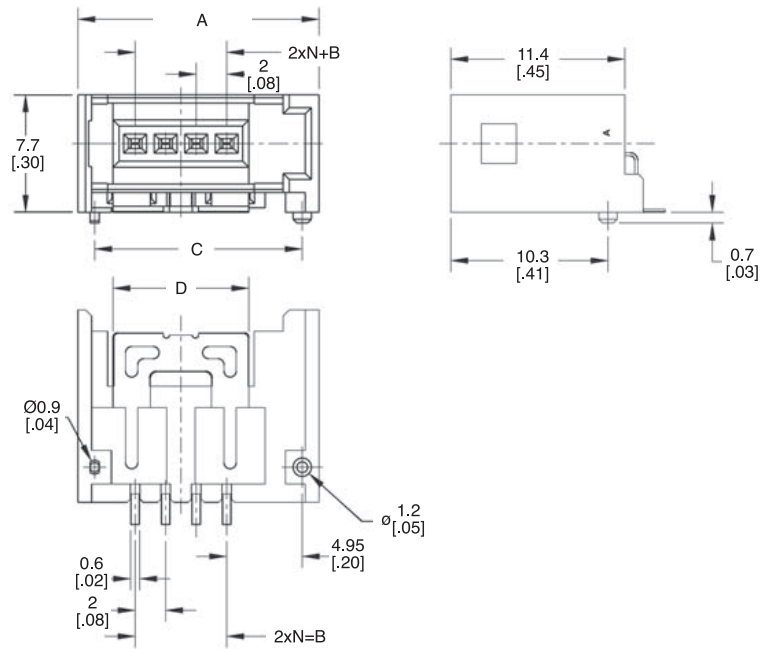

Drawing and PC board layout shows Positioning Boss Holes. Dimensions are for reference only.

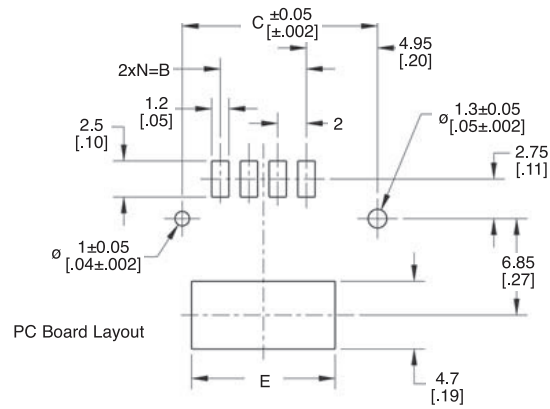

No. of Positions	Dimensions						Part Number	
	N	A	B	C	D	E	with Boss	without Boss
3	2 [.08]	13.8 [.54]	4 [.16]	11.6 [.46]	6.9 [.27]	8 [.31]	1565994-3	1-1565994-3
4	3 [.12]	15.8 [.62]	6 [.24]	13.6 [.54]	8.9 [.35]	10 [.39]	1565994-4	1-1565994-4

Packaged on embossed tapes suitable for automated application.
 Note: All part numbers are RoHS Compliant.

RITS INTERCONNECTION SYSTEM CONNECTORS

Junction Box (2D Type)

x-1473571-x
-3 to -8 shows No. of Positions

Shows connector style:
Blank- Panel Mount Style,
5- Free Hanging Style

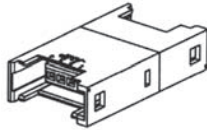

Free Hanging Style

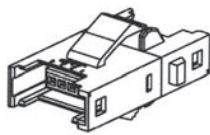

Panel Mount Style

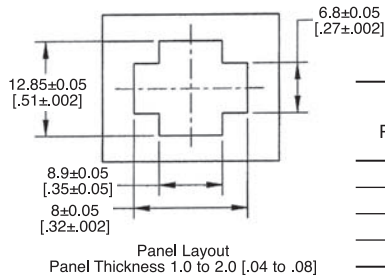
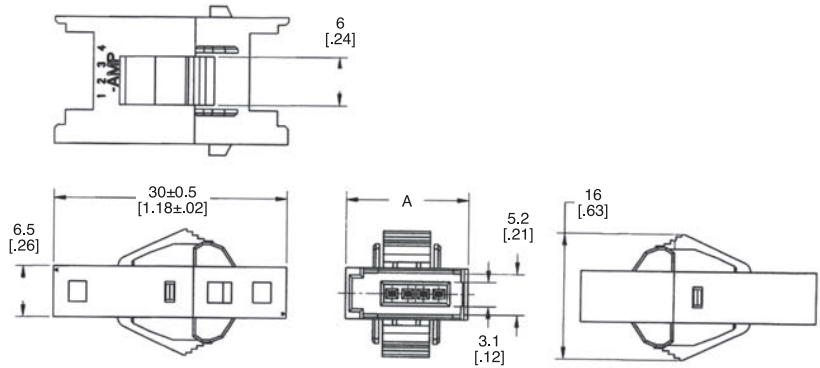

No. of Positions	Dimensions		Part Number	
	A	B	Panel Mount Style	Free Hanging Style
3	13.8 [.54]	14.1 [.56]	1473571-3	5-1473571-3
4	15.8 [.62]	16.1 [.63]	1473571-4	5-1473571-4
6	19.8 [.78]	20.1 [.79]	1473571-6	5-1473571-6
8	23.8 [.94]	24.1 [.95]	1473571-8	5-1473571-8

Note: All part numbers are RoHS Compliant.

Junction Box (4D Type)

x-1473574-x
-3 to -4 shows No. of Position

Shows connector style:
Blank- Panel Mount Style,
5- Free Hanging Style

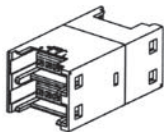

Free Hanging Style

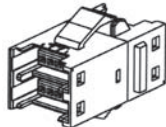

Panel Mount Style

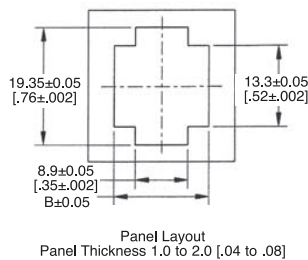
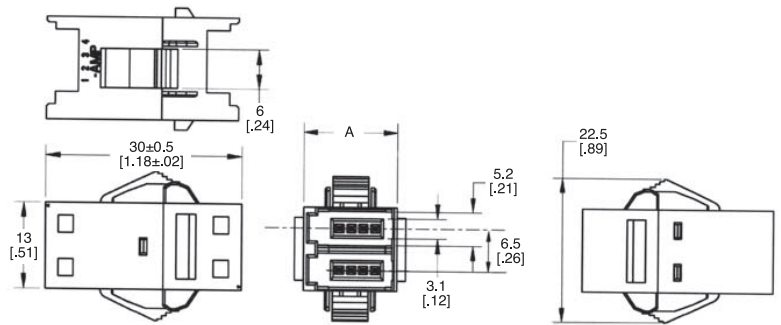

No. of Positions	Dimensions		Part Number	
	A	B	Panel Mount Style	Free Hanging Style
3	13.8 [.54]	14.1 [.56]	1473574-3	5-1473574-3
4	15.8 [.62]	16.1 [.63]	1473574-4	5-1473574-4

Note: All part numbers are RoHS Compliant.

Note: The Junction Box with 4 connector interfaces enables 3 outputs by 1 input. 4 interfaces are commoned as per the drawing.

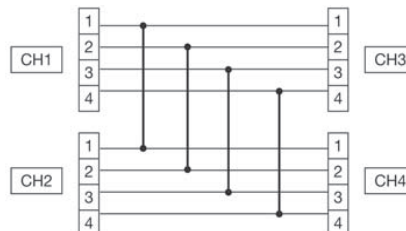

© 2016 TE Connectivity Ltd. Family of Companies. All Rights Reserved.
TE, TE Connectivity, and the TE connectivity (logo) are trademarks of the TE Connectivity Ltd.
family of companies. Other logos, product and Company names mentioned herein may be
trademarks of their respective owners.
1654885 JN 1/16

USA: +1 (800) 522-6752
Canada: +1 (905) 475-6222
Mexico: +52 (0) 55-1106-0800
Latin/S. America: +54 (0) 11-4733-2200
Germany: +49 (0) 6251-133-1999

UK: +44 (0) 800-267666
France: +33 (0) 1-3420-8686
The Netherlands: +31 (0) 73-6246-999
China: +86 (0) 400-820-6015

X-ON Electronics

Largest Supplier of Electrical and Electronic Components

Click to view similar products for [Modular Connectors / Ethernet Connectors](#) category:

Click to view products by [TE Connectivity](#) manufacturer:

Other Similar products are found below :

[RJE231881317T](#) [MP1010RX-1000](#) [MP44RX-1000](#) [GAX-3-66](#) [GAX-8-62](#) [93606-0253](#) [GD-A-44](#) [GDCX-PA-66-50](#) [GDCX-PN-64](#) [GDCX-PN-66](#) [GDCX-PN-66-50](#) [GDLX-A-66](#) [GDLX-A-88](#) [GDLX-N-66](#) [GDLX-S-88K](#) [GDTX-S-88-50](#) [GDX-PA-1010](#) [GLX-N-1010M-BLK](#) [GLX-N-44M](#) [GLX-S-88M-BLK](#) [GMX-N-1010](#) [GMX-S-1010](#) [GMX-S-66](#) [GMX-SMT2-N-1010](#) [GMX-SMT2-N-64-50](#) [GMX-SMT2-S6-88](#) [GMX-SMT4-N-88](#) [GPX-2-64](#) [GRT1-BT1-5](#) [GSGX-N-2-88](#) [GSX-NS2-88-3.05](#) [GSX-NS2-88-3.05-50](#) [GSX-NS-88-3.05-30](#) [GSX-NS-88-3.05-50](#) [GSX-NS-88-3.68](#) [1-1775629-2](#) [GWLX-S-88-GR](#) [GWLX-S9-88-YG](#) [1300500326](#) [1300500227](#) [1300530003](#) [1300570002](#) [1324640-4](#) [RJ11FTVC2G](#) [RJ11FTVC2N](#) [RJFTVX2SA1G](#) [132764-001](#) [1400000](#) [1413176](#) [1413235](#)