

Power Relay RM 8

- 2 pole 25 A, 2 form C (2 CO) contacts
- DC or AC coil
- Mechanical indicator
- Push-to-test button
- Chassis or DIN rail mount

Typical applications
Cleaning equipment, heating and cooling equipment.



Approvals

VDE Cert. No. 40003144, UL E214025,
Technical data of approved types on request.

Contact Data

Contact arrangement	2 form C (CO)
Rated voltage	400VAC
Max. switching voltage	400VAC
Rated current	25A
Limiting making current, 20ms max.	60A
Switching power	6000VA
Contact material	AgCdO, AgNi90/10
Min. recommended contact load	24VDC/100mA
Frequency of operation, with/without load, DC coil	960/6000h ⁻¹
Operate/release time max., DC coil	15/10ms
Bounce time max., form A/form B, DC coil	4/6ms

Contact ratings

Type	Contact	Load	Cycles
IEC 61810			
RM82	C (CO)	25 A, 250 VAC, cosφ=1 DC-coil, 65°C	10x10 ³
RM82	C (CO)	25 A, 250 VAC, cosφ=1 AC-coil, 40°C	10x10 ³
UL 508			
RM80	A/B (NO/NC)	25 A, 240 VAC, 1 phase per pole, general purpose 40°C	6x10 ³
RM8	A/B (NO/NC)	25 A, 415 VAC, resistive, 45°C	10x10 ³
RM82	C (CO)	16 A, 415 VAC, resistive, 70°C	30x10 ³
RM82	A/B (NO/NC)	240 VAC, 1 phase, 2HP, 50°C	6x10 ³

Mechanical endurance 10x10⁶ operations

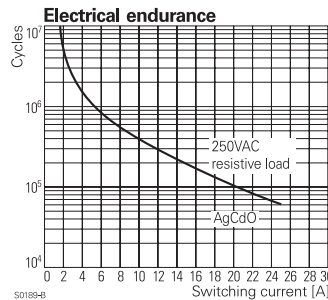
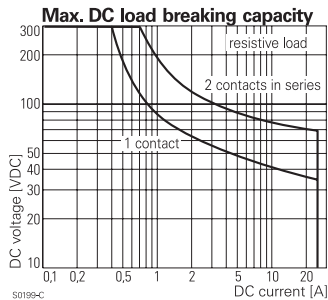

Coil Data

Coil voltage range	6 to 220VDC 6 to 400VAC
Operative range, IEC 61810	2
Coil insulation system according UL	class 130 (B)

Coil versions, DC coil

STD	LED bipolar	Coil code PD ³⁾	LED+ PD ³⁾	Rated voltage VDC	Coil resistance Ω±10% ¹⁾²⁾	Rated coil power W
006	L06	0A6	LA6	6	32	1.1
012	L12	0B2	LB2	12	110	1.3
024	L24	0C4	LC4	24	475	1.2
048	L48	0E8	LE8	48	2000	1.2
060	L60	0G0	LG0	60	2850	1.3
110	M10	1B0	MB0	110	10000 ¹⁾	1.2
221	N21	2C1	NC1	220	40000 ²⁾	1.2

Operate voltage, DC coil 75% of rated coil voltage
Release voltage, DC coil 10% of rated coil voltage

1) Coil resistance ±12%, 2) Coil resistance ±15%.
3) Protection diode PD; standard polarity: +A1 / -A2.
All figures are given for coil without pre-energization, at ambient temperature +23°C.

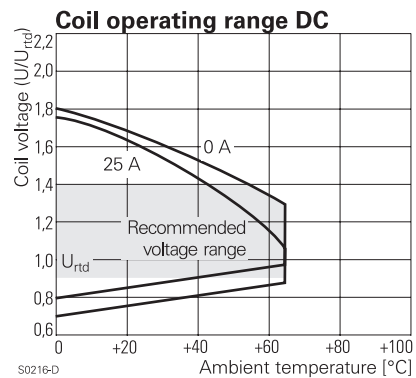

Power Relay RM 8 (Continued)

Coil Data (continued)

Coil versions, AC coil

Coil code	Rated voltage	Operate voltage	Release voltage	Coil resistance	Rated coil power	
STD	LED	50/60Hz	50/60Hz	$\Omega_{\pm 10\%^{12)}$	50/60Hz	
		VAC	VAC	VAC	VA	
506	R06	6	4.8/5.1	1.8	4.7	2.86/2.36
512	R12	12	9.6/10.2	3.6	19.5	2.71/2.27
524	R24	24	19.2/20.4	7.2	80	2.62/2.00
548	R48	48	38.4/40.8	14.4	320	2.60/2.17
560	R60	60	48.0/51.0	18.0	500	2.62/2.20
615	S15	115	92.0/97.8	34.5	1850	2.65/2.22
730	T30	230	184.0/195.5	69.0	7500	2.69/ 2.26
900	V00	400	320.0/340.0	120.0	23500 ²⁾	2.61/2.20

2) Coil resistance $\pm 15\%$.

All figures are given for coil without pre-energization, at ambient temperature +23°C.

Insulation Data

Initial dielectric strength	
between open contacts	1500Vrms
between contact and coil	2500Vrms
between adjacent contacts	4000Vrms
Initial surge withstand voltage	
between contact and coil	5000V(1.2/50 μ s)
between adjacent contacts	6000V(1.2/50 μ s)
Clearance/creepage	
between contact and coil	$\geq 4.0/14.9$ mm
between adjacent contacts	$\geq 15.3/15.3$ mm
Material group of insulation parts	IIIa

Other Data

Material compliance: EU RoHS/ELV, China RoHS, REACH, Halogen content refer to the Product Compliance Support Center at www.te.com/customer-support/rohssupportcenter

Ambient temperature	
for mounting/handling	-20 to +40°C
in operation	
DC coil	-40 to +65°C
AC coil	-40 to +40°C
16 A contact load	-40 to +70°C
Category of environmental protection	
IEC 61810	RT1 - dust protected
Vibration resistance (functional)	
form A (NO)/form B (NC)	10/5g, 30 to 150Hz
Terminal type	quick-connect
Cover retention, pull/push force	100/100N
Weight	81g
Packaging unit	10/25 pcs.

Terminal assignment

Bottom view on pins

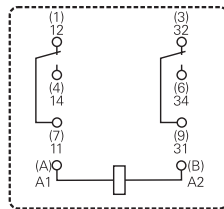
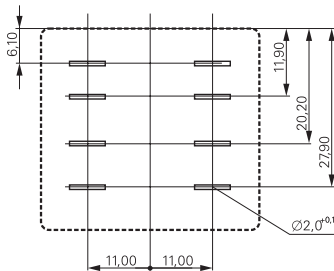

Dimensions

Cover with mounting brackets, 6.3mm quick connect terminals

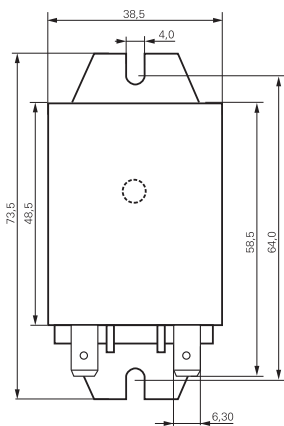

Cover with DIN-snap-on attachment

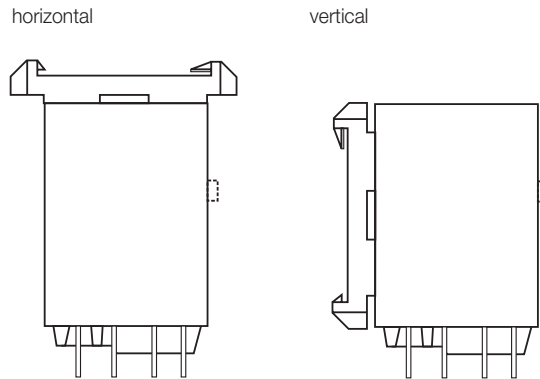

Power Relay RM 8 (Continued)

Product code structure

Typical product code **RM 8 0 9 024**

Type	RM Power relay RM8												
Contact configuration	8 2 form C contacts (2 CO), 25A												
Version	<table border="0"> <tr> <td>0</td> <td>AgCdO, without test button</td> <td>3</td> <td>AgCdO, with test button</td> </tr> <tr> <td>2</td> <td>AgNi90/10, without test button</td> <td>7</td> <td>AgNi90/10, with test button</td> </tr> </table>					0	AgCdO, without test button	3	AgCdO, with test button	2	AgNi90/10, without test button	7	AgNi90/10, with test button
0	AgCdO, without test button	3	AgCdO, with test button										
2	AgNi90/10, without test button	7	AgNi90/10, with test button										
Enclosure	<table border="0"> <tr> <td>5</td> <td>cover with mounting brackets, 6.3mm quick connect terminals</td> </tr> <tr> <td>8</td> <td>cover with DIN-snap-on attachment, horizontal, 6.3mm quick connect terminals</td> </tr> <tr> <td>9</td> <td>cover with DIN-snap-on attachment, vertical, 6.3mm quick connect terminals</td> </tr> </table>					5	cover with mounting brackets, 6.3mm quick connect terminals	8	cover with DIN-snap-on attachment, horizontal, 6.3mm quick connect terminals	9	cover with DIN-snap-on attachment, vertical, 6.3mm quick connect terminals		
5	cover with mounting brackets, 6.3mm quick connect terminals												
8	cover with DIN-snap-on attachment, horizontal, 6.3mm quick connect terminals												
9	cover with DIN-snap-on attachment, vertical, 6.3mm quick connect terminals												
Coil	Coil code: please refer to coil versions table												

Product code	Contacts	Cont. material	Version	Enclosure	Coil	Coil	Part number
RM825012	2 form C,	AgNi	Without	Mounting brackets	DC-coil	12VDC	4-1415546-4
RM825024	2 CO contacts	AgNi	test button	quick c. 6.3 mm	DC-coil	24VDC	7-1415544-3
RM805024	25 A	AgCdO			DC-coil	24VDC	2-1393844-7
RM825524		AgNi			AC-coil	24VAC	4-1415546-5
RM805524		AgCdO			AC-coil	24VAC	2-1393147-9
RM825615		AgNi			AC-coil	115VAC	4-1415546-6
RM805615		AgCdO			AC-coil	115VAC	3-1393147-1
RM825730		AgNi			AC-coil	230VAC	5-1415544-8
RM805730		AgCdO			AC-coil	230VAC	3-1393147-3
RM808024		AgCdO		DIN-snap-on horizontal	DC-coil	24VDC	2-1393844-9
RM808730		AgCdO		DIN-snap-on horizontal	AC-coil	230VAC	5-1393149-7
RM829024		AgNi		DIN-snap-on vertical	DC-coil	24VDC	4-1415546-7
RM809024		AgCdO		DIN-snap-on vertical	DC-coil	24VDC	5-1393149-8
RM809615		AgCdO			AC-coil	115VAC	3-1393147-8
RM829730		AgNi			AC-coil	230VAC	4-1415546-8
RM875024		AgNi	With test button	Mounting brackets quick c. 6.3 mm	DC-coil	24VDC	4-1415546-9
RM835024		AgCdO	With test button	Mounting brackets quick c. 6.3 mm	DC-coil	24VDC	4-1393147-1
RM875048		AgNi			DC-coil	48VDC	5-1415546-0
RM875730		AgNi			AC-coil	230VAC	5-1415546-1
RM835730		AgCdO			AC-coil	230VAC	4-1393147-6
RM878012		AgNi		DIN-snap-on horizontal	DC-coil	12VDC	5-1415546-2
RM878024		AgNi		DIN-snap-on horizontal	DC-coil	24VDC	5-1415546-3
RM838024		AgCdO			DC-coil	24VDC	5-1415546-3
RM879024		AgNi		DIN-snap-on vertical	DC-coil	24VDC	5-1415546-4
RM839024		AgCdO		DIN-snap-on vertical	DC-coil	24VDC	5-1393147-4
RM839730		AgCdO			AC-coil	230VAC	5-1393147-6

X-ON Electronics

Largest Supplier of Electrical and Electronic Components

Click to view similar products for [General Purpose Relays](#) category:

Click to view products by [TE Connectivity](#) manufacturer:

Other Similar products are found below :

[APF30318](#) [JVN1AF-4.5V-F](#) [PCN-105D3MHZ](#) [5JO-10000S-SIL](#) [5JO-1000CD-SIL](#) [5JO-400CD-SIL](#) [LY2S-AC220/240](#) [LYQ20DC12](#)
[6031007G](#) [6131406HQ](#) [6-1393099-3](#) [6-1393099-8](#) [6-1393122-4](#) [6-1393123-2](#) [6-1393767-1](#) [6-1393843-7](#) [6-1415012-1](#) [6-1419102-2](#) [6-](#)
[1423698-4](#) [6-1608051-6](#) [6-1608067-0](#) [6-1616170-6](#) [6-1616248-2](#) [6-1616282-3](#) [6-1616348-2](#) [6-1616350-1](#) [6-1616350-8](#) [6-1616358-7](#) [6-](#)
[1616359-9](#) [6-1616360-9](#) [6-1616931-6](#) [6-1617039-1](#) [6-1617052-1](#) [6-1617090-2](#) [6-1617090-5](#) [6-1617347-5](#) [6-1617353-3](#) [6-1617801-8](#) [6-](#)
[1617802-2](#) [6-1618107-9](#) [6-1618248-4](#) [M83536/1-027M](#) [CX-4014](#) [MAHC-5494](#) [MAVCD-5419-6](#) [703XCX-120A](#) [7-1393100-5](#) [7-1393111-7](#)
[7-1393144-5](#) [7-1393767-8](#)