

REVISIONS				
P	LTN	DESCRIPTION	DATE	APVD
K1		REVISED PER ECO-11-004820	11MAR2011	RK HMR
L		REVISED PER ECO-17-002214	29MAY2017	RS MM

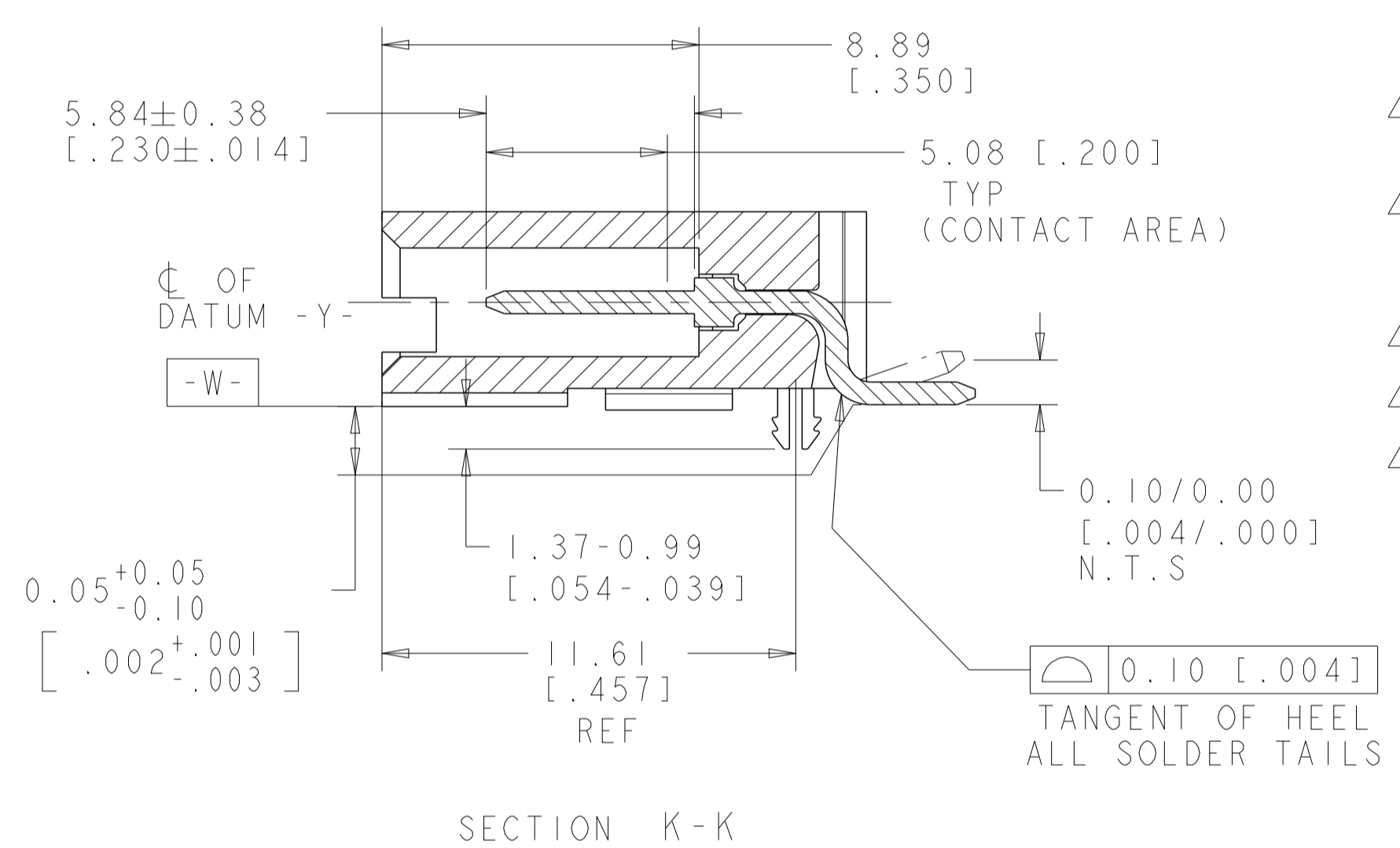

- △ HOUSING: LCP, COLOR-BLACK.
POST: BRASS.
- △ POST: 0.000381 [.000015] MIN GOLD ON THE CONTACT AREA,
0.00254-0.00508 [.000100-.000200] MIN MATTE
TIN-LEAD ON THE SOLDER TAILS, ALL OVER 0.00127 [.000050] NICKEL.
- △ DATUMS AND BASIC DIMENSIONS ESTABLISHED BY THE CUSTOMER.
- △ TWO POLARIZATION SLOTS ON ASSEMBLIES WITH FOUR OR MORE POSITIONS.
- △ POST: 0.000381 [.000015] MIN GOLD ON THE CONTACT AREA,
0.00254-0.00508 [.000100-.000200] MIN MATTE
TIN ON THE SOLDER TAILS, ALL OVER 0.00127 [.000050] NICKEL.

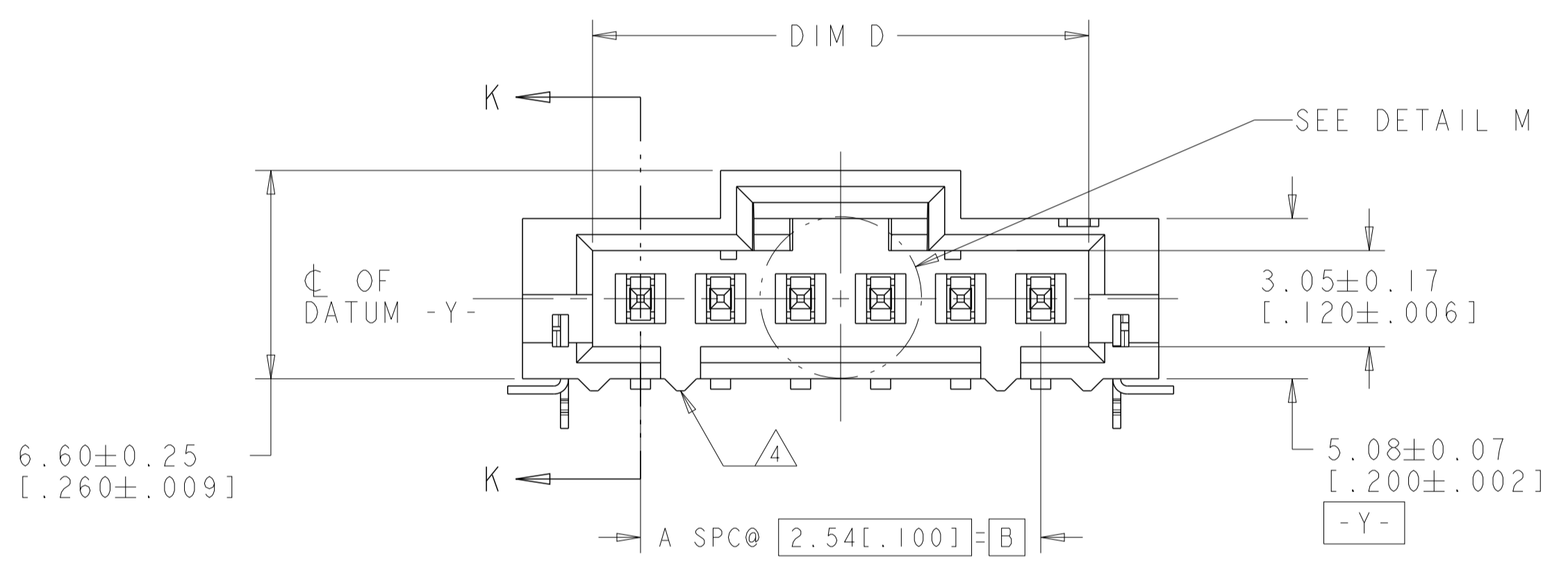
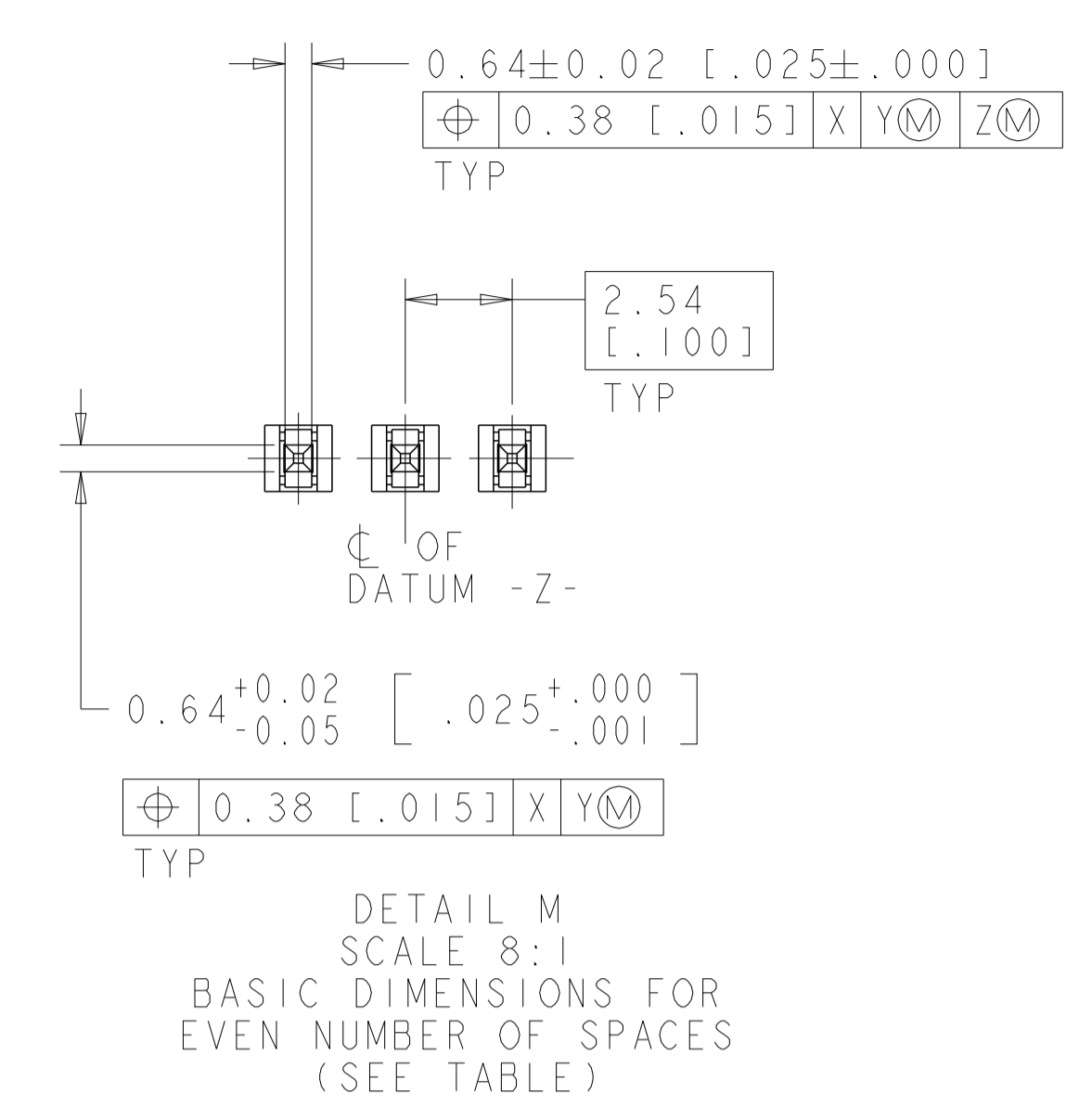
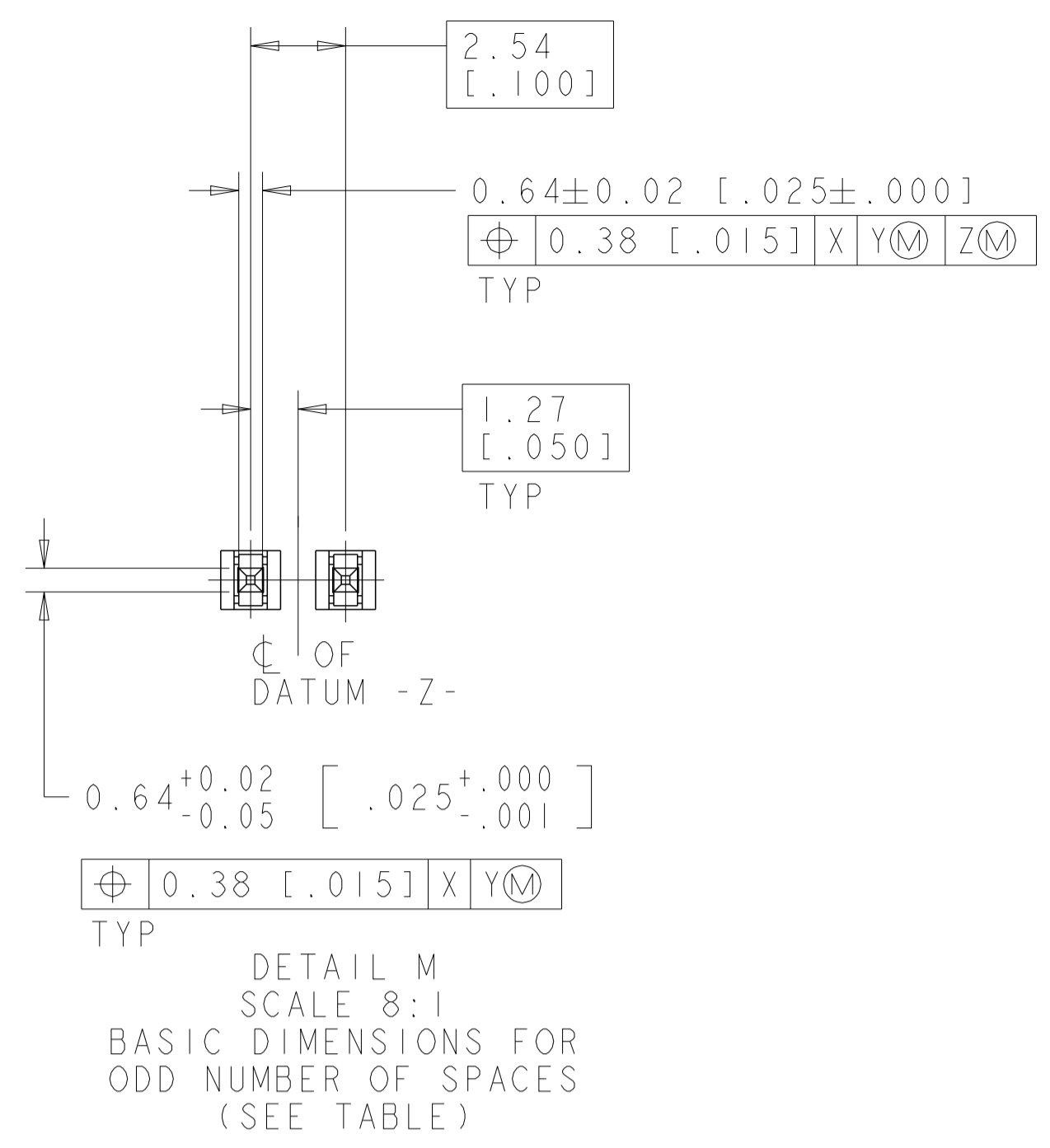
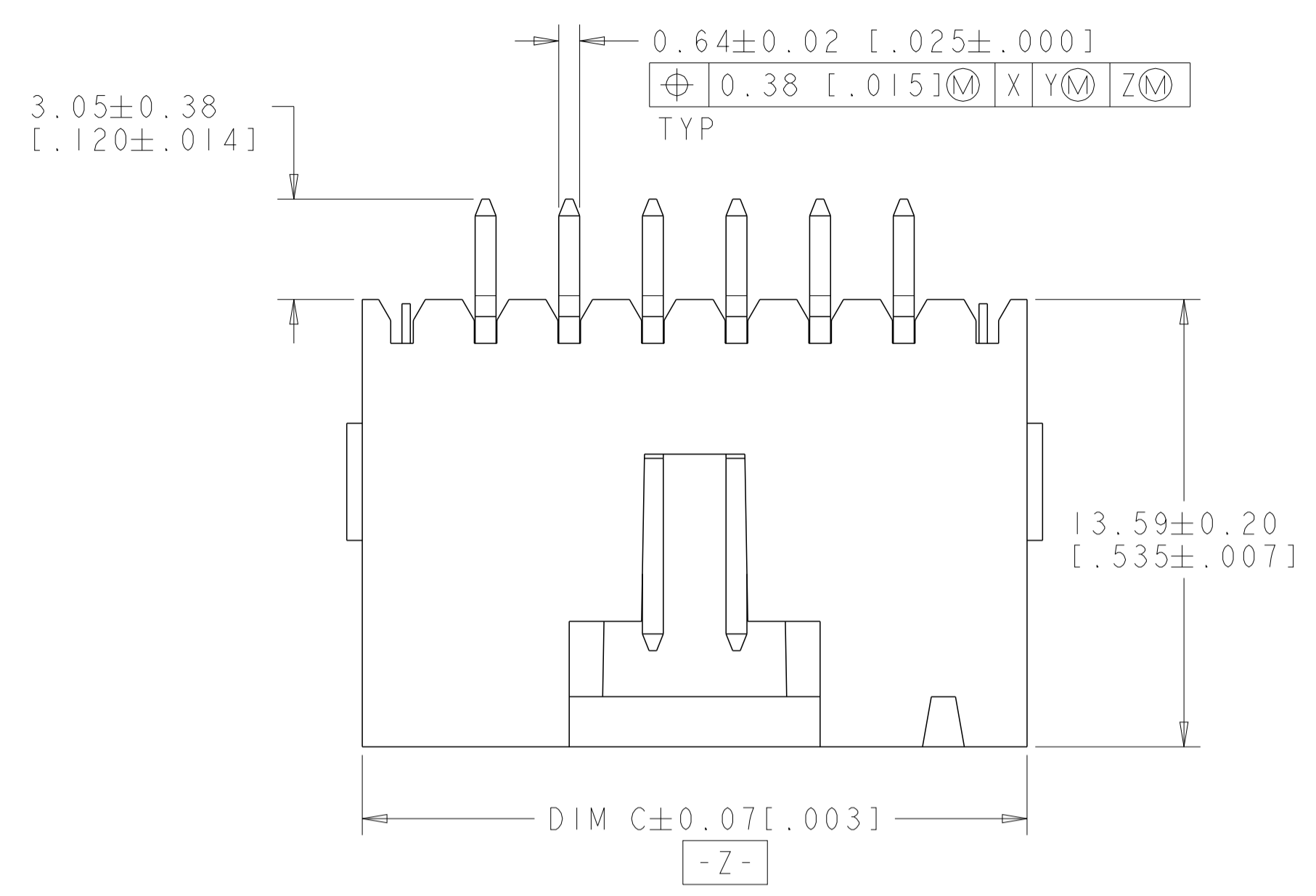
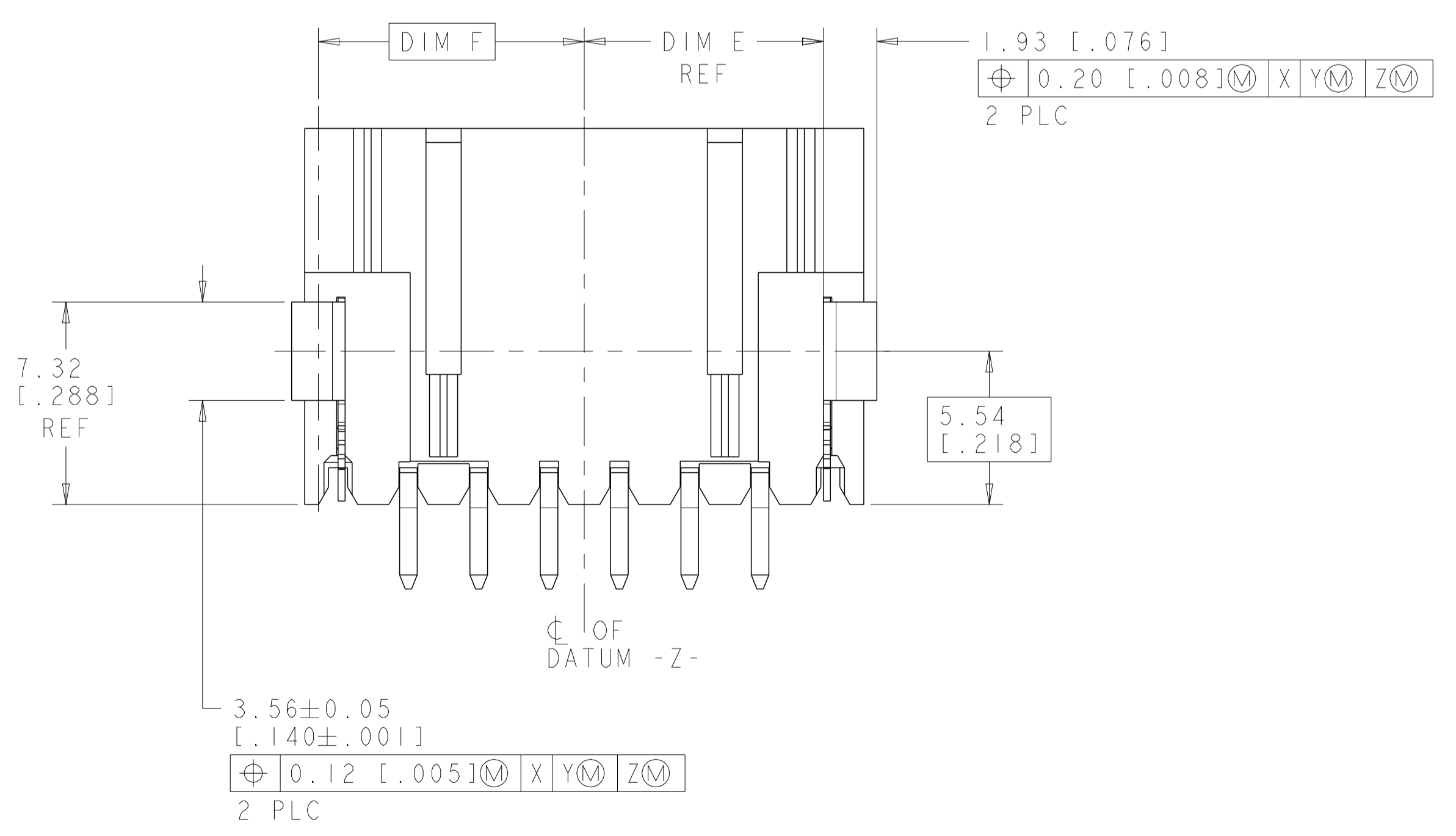

SEE TABLE ON SHEET #3 & #4

THIS DRAWING IS A CONTROLLED DOCUMENT.		DWN: B. HAYMAKER 01APR99	TE Connectivity
DIMENSIONS: mm [INCHES]		CHK: M. CHIANG 01APR99	
TOLERANCES UNLESS OTHERWISE SPECIFIED:		APVD: M. CHIANG 01APR99	NAME: HEADER ASSEMBLY, LATCHING, RIGHT ANGLE SURFACE MOUNT, MTE,
0 PLC ±	1 PLC ±	PRODUCT SPEC	APPLICATION SPEC
2 PLC ±	3 PLC ±	SIZE	CAGE CODE
4 PLC ±	ANGLES ±	DRAWING NO	RESTRICTED TO
MATERIAL	FINISH	WEIGHT	A100779C=147278
CUSTOMER DRAWING		SCALE	SHEET OF REV

REVISIONS				
P.	LTN.	DESCRIPTION	DATE	APVD.
-	-	SEE SHEET 1	-	-

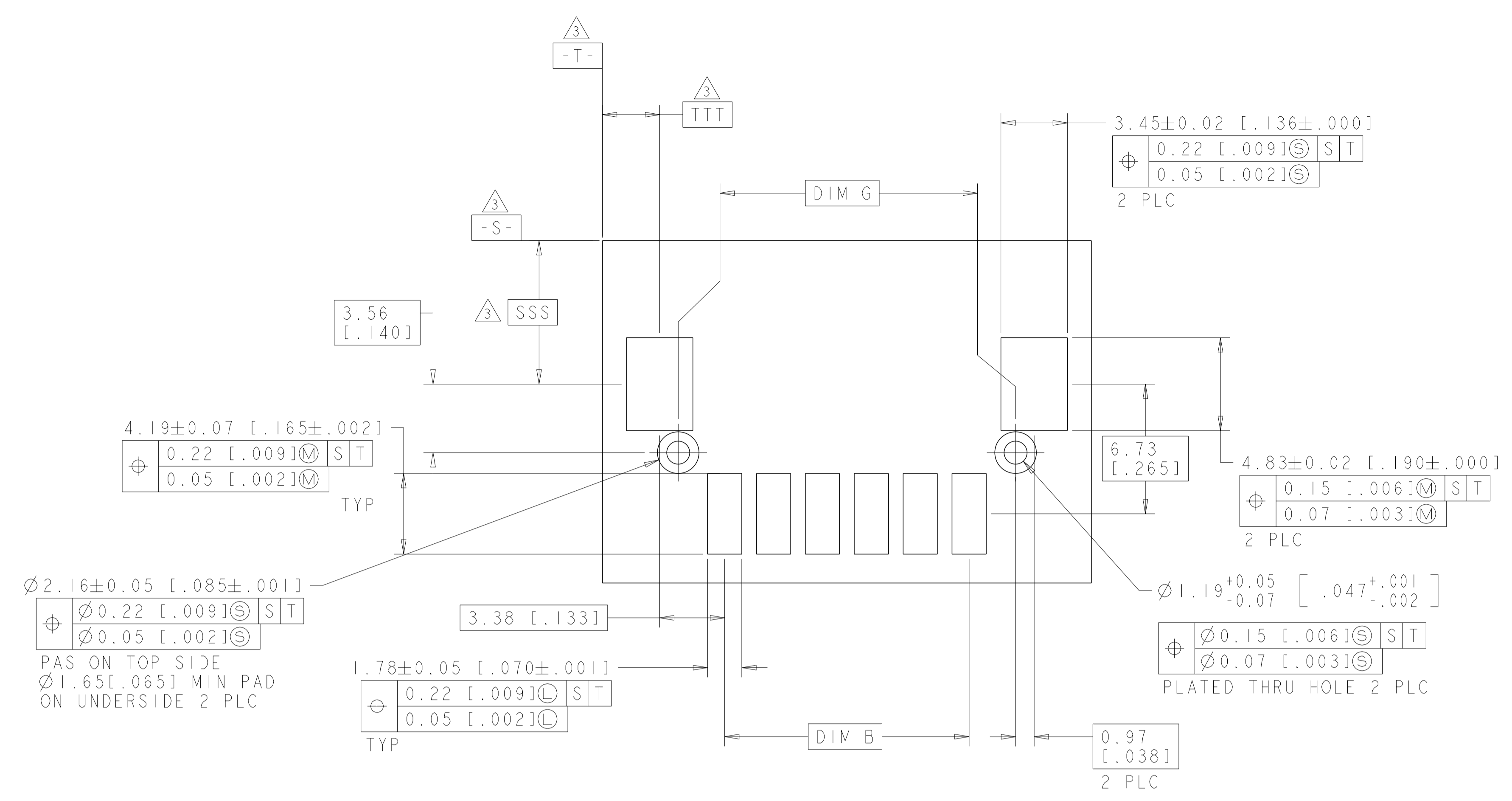

RECOMMENDED PC BOARD LAYOUT

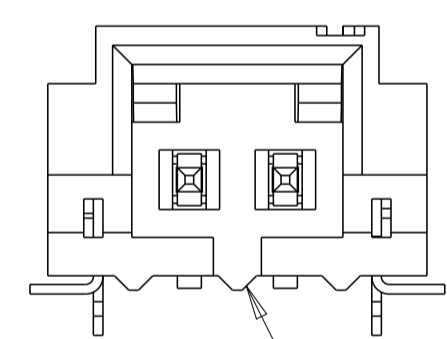

POLARIZATION SLOT FOR TWO POSITION

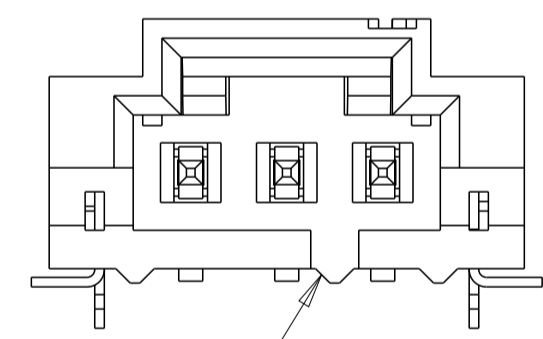

POLARIZING SLOT FOR THREE POSITION

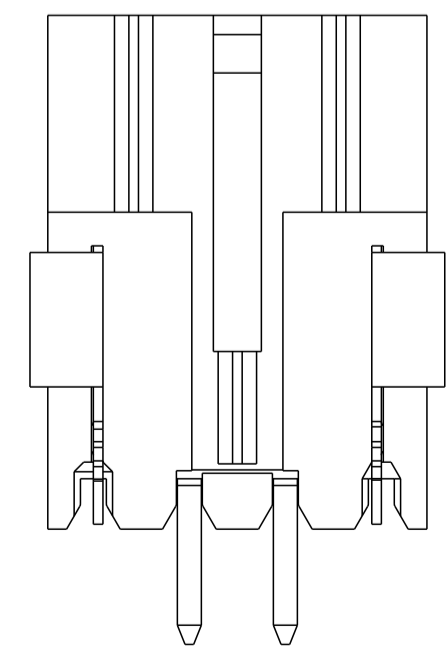

147278-1

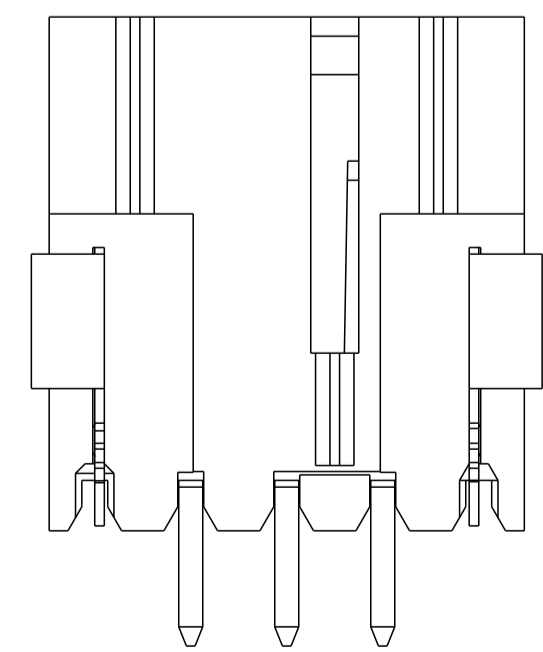

147278-2

THIS DRAWING IS A CONTROLLED DOCUMENT.		DWN: B. HAYMAKER 01APR99 CHK: M. CHIANG 01APR99 APVD: M. CHIANG 01APR99	TE Connectivity
DIMENSIONS: mm [INCHES]	TOLERANCES UNLESS OTHERWISE SPECIFIED: 0 PLC ± 1 PLC ± 2 PLC ± 3 PLC ± 4 PLC ±0.13 (1.005) ANGLES ±	NAME: HEADER ASSEMBLY, LATCHING, RIGHT ANGLE SURFACE MOUNT, MTE, SIZE: CAGE CODE: DRAWING NO: WEIGHT: A100779C=147278	
MATERIAL:	FINISH:	APPLICATION SPEC: CUSTOMER DRAWING	RESTRICTED TO: SCALE: 6:1 SHEET 2 OF 4 REV 1

THIS DRAWING IS UNPUBLISHED. RELEASED FOR PUBLICATION
 © COPYRIGHT copyright © STC ALL RIGHTS RESERVED.

REVISIONS				
P	LTN	DESCRIPTION	DATE	APVD
-	-	SEE SHEET 1	-	-

△	88	65.79 [2.590]	33.73 [1.328]	32.77 [1.290]	64.01 [2.520]	68.45 [2.695]	60.96 [2.400]	24	25	2-147278-4
△	88	63.25 [2.490]	32.46 [1.278]	31.50 [1.240]	61.47 [2.420]	65.91 [2.595]	58.42 [2.300]	23	24	2-147278-3
△	88	60.71 [2.390]	31.19 [1.228]	30.23 [1.190]	58.93 [2.320]	63.37 [2.495]	55.88 [2.200]	22	23	2-147278-2
△	88	58.17 [2.290]	29.92 [1.178]	28.96 [1.140]	56.39 [2.220]	60.83 [2.395]	53.34 [2.100]	21	22	2-147278-1
△	88	55.63 [2.190]	28.65 [1.128]	27.69 [1.090]	53.85 [2.120]	58.29 [2.295]	50.80 [2.000]	20	21	2-147278-0
△	72	53.09 [2.090]	27.38 [1.078]	26.42 [1.040]	51.31 [2.020]	55.75 [2.195]	48.26 [1.900]	19	20	1-147278-9
△	72	50.55 [1.990]	26.11 [1.028]	25.15 [1.990]	48.77 [1.920]	53.21 [2.095]	45.72 [1.800]	18	19	1-147278-8
△	72	48.01 [1.890]	24.84 [1.978]	23.88 [1.940]	46.23 [1.820]	50.67 [1.995]	43.18 [1.700]	17	18	1-147278-7
△	72	45.47 [1.790]	23.57 [1.928]	22.61 [1.890]	43.69 [1.720]	48.13 [1.895]	40.64 [1.600]	16	17	1-147278-6
△	72	42.93 [1.690]	22.30 [1.878]	21.34 [1.840]	41.15 [1.620]	45.59 [1.795]	38.10 [1.500]	15	16	1-147278-5
△	72	40.39 [1.590]	21.03 [1.828]	20.07 [1.790]	38.61 [1.520]	43.05 [1.695]	35.56 [1.400]	14	15	1-147278-4
△	56	37.85 [1.490]	19.76 [1.778]	18.80 [1.740]	36.07 [1.420]	40.51 [1.595]	33.02 [1.300]	13	14	1-147278-3
△	56	35.31 [1.390]	18.49 [1.728]	17.53 [1.690]	33.53 [1.320]	37.97 [1.495]	30.48 [1.200]	12	13	1-147278-2
△	56	32.77 [1.290]	17.22 [1.678]	16.26 [1.640]	30.99 [1.220]	35.43 [1.395]	27.94 [1.100]	11	12	1-147278-1
△	56	30.23 [1.190]	15.95 [1.628]	14.99 [1.590]	28.45 [1.120]	32.89 [1.295]	25.40 [1.000]	10	11	1-147278-0
△	44	27.69 [1.090]	14.68 [1.578]	13.72 [1.540]	25.91 [1.020]	30.35 [1.195]	22.86 [1.900]	9	10	147278-9
△	44	25.15 [1.990]	13.41 [1.528]	12.45 [1.490]	23.37 [1.920]	27.81 [1.095]	20.32 [1.800]	8	9	147278-8
△	44	22.61 [1.890]	12.14 [1.478]	11.18 [1.440]	20.83 [1.820]	25.27 [1.995]	17.78 [1.700]	7	8	147278-7
△	44	20.07 [1.790]	10.87 [1.428]	9.91 [1.390]	18.29 [1.720]	22.73 [1.895]	15.24 [1.600]	6	7	147278-6
△	44	17.53 [1.690]	9.60 [1.378]	8.64 [1.340]	15.75 [1.620]	20.19 [1.795]	12.70 [1.500]	5	6	147278-5
△	32	14.99 [1.590]	8.33 [1.328]	7.37 [1.290]	13.21 [1.520]	17.65 [1.695]	10.16 [1.400]	4	5	147278-4
△	24	12.45 [1.490]	7.06 [1.278]	6.10 [1.240]	10.67 [1.420]	15.11 [1.595]	7.62 [1.300]	3	4	147278-3
△	24	9.91 [1.390]	5.79 [1.228]	4.83 [1.190]	8.13 [1.320]	12.57 [1.495]	5.08 [1.200]	2	3	147278-2
△	24	7.37 [1.290]	4.52 [1.178]	3.56 [1.140]	5.59 [1.220]	10.03 [1.395]	2.54 [1.100]	1	2	147278-1
PLATING	EIA 481 TAPE WIDTH mm	G	F	E	D	C	B	A	NO OF POSN	PART NUMBER

THIS DRAWING IS A CONTROLLED DOCUMENT.

DIMENSIONS: mm [INCHES]	TOLERANCES UNLESS OTHERWISE SPECIFIED: 0 PLC ± 1 PLC ± 2 PLC ± 3 PLC ± 4 PLC ±0.13 (1.005) ANGLES ± FINISH	DWN: B. HAYMAKER 01APR99 CHK: M. CHIANG 01APR99 APVD: M. CHIANG 01APR99	 TE Connectivity
MATERIAL: -	WEIGHT: -	SIZE: A100779	NAME: HEADER ASSEMBLY, LATCHING, RIGHT ANGLE SURFACE MOUNT, MTE,
CUSTOMER DRAWING		SCALE: 6:1	RESTRICTED TO: -

4805 (3/13)

THIS DRAWING IS UNPUBLISHED.	RELEASED FOR PUBLICATION
© COPYRIGHT copyright © STE	ALL RIGHTS RESERVED.

REVISIONS				
P	LTN	DESCRIPTION	DATE	APVD
-	-	SEE SHEET 1	-	-

△5	88	65.79 [2.590]	33.73 [1.328]	32.77 [1.290]	64.01 [2.520]	68.45 [2.695]	60.96 [2.400]	24	25	2-147278-4
△5	88	63.25 [2.490]	32.46 [1.278]	31.50 [1.240]	61.47 [2.420]	65.91 [2.595]	58.42 [2.300]	23	24	2-147278-3
△5	88	60.71 [2.390]	31.19 [1.228]	30.23 [1.190]	58.93 [2.320]	63.37 [2.495]	55.88 [2.200]	22	23	2-147278-2
△5	88	58.17 [2.290]	29.92 [1.178]	28.96 [1.140]	56.39 [2.220]	60.83 [2.395]	53.34 [2.100]	21	22	2-147278-1
△5	88	55.63 [2.190]	28.65 [1.128]	27.69 [1.090]	53.85 [2.120]	58.29 [2.295]	50.80 [2.000]	20	21	2-147278-0
△5	72	53.09 [2.090]	27.38 [1.078]	26.42 [1.040]	51.31 [2.020]	55.75 [2.195]	48.26 [1.900]	19	20	1-147278-9
△5	72	50.55 [1.990]	26.11 [1.028]	25.15 [.990]	48.77 [1.920]	53.21 [2.095]	45.72 [1.800]	18	19	1-147278-8
△5	72	48.01 [1.890]	24.84 [.978]	23.88 [.940]	46.23 [1.820]	50.67 [1.995]	43.18 [1.700]	17	18	1-147278-7
△5	72	45.47 [1.790]	23.57 [.928]	22.61 [.890]	43.69 [1.720]	48.13 [1.895]	40.64 [1.600]	16	17	1-147278-6
△5	72	42.93 [1.690]	22.30 [.878]	21.34 [.840]	41.15 [1.620]	45.59 [1.795]	38.10 [1.500]	15	16	1-147278-5
△5	72	40.39 [1.590]	21.03 [.828]	20.07 [.790]	38.61 [1.520]	43.05 [1.695]	35.56 [1.400]	14	15	1-147278-4
△5	56	37.85 [1.490]	19.76 [.778]	18.80 [.740]	36.07 [1.420]	40.51 [1.595]	33.02 [1.300]	13	14	1-147278-3
△5	56	35.31 [1.390]	18.49 [.728]	17.53 [.690]	33.53 [1.320]	37.97 [1.495]	30.48 [1.200]	12	13	1-147278-2
△5	56	32.77 [1.290]	17.22 [.678]	16.26 [.640]	30.99 [1.220]	35.43 [1.395]	27.94 [1.100]	11	12	1-147278-1
△5	56	30.23 [1.190]	15.95 [.628]	14.99 [.590]	28.45 [1.120]	32.89 [1.295]	25.40 [1.000]	10	11	1-147278-0
△5	44	27.69 [1.090]	14.68 [.578]	13.72 [.540]	25.91 [1.020]	30.35 [1.195]	22.86 [.900]	9	10	147278-9
△5	44	25.15 [.990]	13.41 [.528]	12.45 [.490]	23.37 [.920]	27.81 [1.095]	20.32 [.800]	8	9	147278-8
△5	44	22.61 [.890]	12.14 [.478]	11.18 [.440]	20.83 [.820]	25.27 [.995]	17.78 [.700]	7	8	147278-7
△5	44	20.07 [.790]	10.87 [.428]	9.91 [.390]	18.29 [.720]	22.73 [.895]	15.24 [.600]	6	7	147278-6
△5	44	17.53 [.690]	9.60 [.378]	8.64 [.340]	15.75 [.620]	20.19 [.795]	12.70 [.500]	5	6	147278-5
△5	32	14.99 [.590]	8.33 [.328]	7.37 [.290]	13.21 [.520]	17.65 [.695]	10.16 [.400]	4	5	147278-4
△5	24	12.45 [.490]	7.06 [.278]	6.10 [.240]	10.67 [.420]	15.11 [.595]	7.62 [.300]	3	4	147278-3
△5	24	9.91 [.390]	5.79 [.228]	4.83 [.190]	8.13 [.320]	12.57 [.495]	5.08 [.200]	2	3	147278-2
△5	24	7.37 [.290]	4.52 [.178]	3.56 [.140]	5.59 [.220]	10.03 [.395]	2.54 [.100]	1	2	147278-1
PLATING	EIA 481 TAPE WIDTH mm	G	F	E	D	C	B	A	NO OF POSN	PART NUMBER

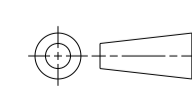
THIS DRAWING IS A CONTROLLED DOCUMENT.		DWN B. HAYMAKER 01APR99 CHK M. CHIANG 01APR99 APVD M. CHIANG 01APR99	 TE Connectivity
DIMENSIONS: mm [INCHES]	TOLERANCES UNLESS OTHERWISE SPECIFIED:	NAME HEADER ASSEMBLY, LATCHING, RIGHT ANGLE SURFACE MOUNT, MTE,	
	0 PLC ± 1 PLC ± 2 PLC ± 3 PLC ± 4 PLC ± ANGLES ± FINISH ±	PRODUCT SPEC APPLICATION SPEC	SIZE CAGE CODE DRAWING NO A100779 ©=147278
MATERIAL		WEIGHT	RESTRICTED TO
CUSTOMER DRAWING		SCALE 6:1	SHEET 4 OF 4 REV 1

X-ON Electronics

Largest Supplier of Electrical and Electronic Components

Click to view similar products for [Headers & Wire Housings](#) category:

Click to view products by [TE Connectivity](#) manufacturer:

Other Similar products are found below :

[95000-104TRLF](#) [10135584-644402LF](#) [DF62W-EP2022PCA](#) [95000-106TRLF](#) [DF62W-2022SCA](#) [DF62W-EP2022PC](#) [2203348](#) [DF62W-2022SC](#) [1084018](#) [1029039](#) [1084017](#) [802-10-012-10-002000](#) [1112640](#) [1112639](#) [000-34000](#) [0009482033](#) [0009507031](#) [57102-S06-03LF](#) [57202-S52-04LF](#) [PCN6-15S-2.5E](#) [0039019024](#) [58102-G61-06LF](#) [582553-1](#) [0009485154](#) [0009508121](#) [0022285053](#) [0050291907](#) [018731A](#) [LY20-4P-DT1-P1E-BR](#) [02.125.8002.8](#) [60101931](#) [60598-1 \(Cut Strip\)](#) [M1625-3R/100](#) [61062-3](#) [61082-181009](#) [636-1427](#) [638009-1](#) [641938-9](#) [641991-4](#) [644168-1](#) [647662-1](#) [65039-019ELF](#) [65817-002LF](#) [65817-015LF](#) [65863-015LF](#) [66207-023LF](#) [67016-026LF](#) [67046-001LF](#) [67095-007LF](#) [67230-005LF](#)