



# MAGNET WIRE TERMINALS AND TERMINATION SYSTEMS

MAG-MATE terminals, SIAMEZE terminals, AMPLIVAR terminals and splices, and cluster blocks

**Table of Contents**

**Standard MAG-MATE Terminals**

Introduction.....	1
Interconnection System.....	2
Termination Sequence.....	2
Test Results.....	3
300 Box Poke-In Terminals.....	4
500 Box Poke-In Terminals.....	6
Poke-In Tab Terminals.....	7
MAG-MATE Terminals with extended leaf-spring.....	8
300 Box Poke-In Terminals.....	9
Tab Receptacle Terminals.....	9
187 Box F-Crimp Terminals.....	10
300 Box F-Crimp Terminals.....	10
Posted PCB Terminals.....	11
300 Box Posted PCB Terminals.....	11
MAG-MATE Edge Leaf Terminals.....	12
187 Box Posted PCB Terminals.....	13
187 Box Tab Terminals.....	13
300 Box Tab Terminals.....	14
Pin Receptacle Terminals.....	15
Pin I/O Terminals.....	16
110 Series FASTON Tab Terminals.....	17
187 Series FASTON Tab Terminals.....	18
187 Series Combination Poke-In FASTON Terminals.....	18
250 Series FASTON Tab Terminals.....	21
Typical Plastic Cavity.....	23

**Slim Line MAG-MATE Terminals**

Introduction.....	25
187 Series FASTON Tab Terminals.....	26
250 Series FASTON Tab Terminals.....	26
Posted PCB SOLDER Terminal.....	26
Offset Tab Terminals.....	27

**Mini MAG-MATE Terminals**

Introduction.....	29
Poke-In Terminal.....	30
Posted Terminal.....	31
FASTON Tab Terminals.....	31
Crimp Wire Barrel Terminal.....	31

**SIAMEZE Terminals**

Introduction.....	32
Lead Lok Terminals Introduction.....	33
SIAMEZE Interconnection System.....	34
Lead Lok Interconnection System.....	35
Wire-to-Wire Terminals.....	36
Receptacle Terminals (Wire to Blade).....	37
Pin Terminals.....	37
Post Terminals.....	38
110 Series (2.8 mm wide) FASTON Tab Terminals.....	39
187 Series (4.75 mm wide) FASTON Tab Terminals.....	40
250 Series (6.3 mm wide) FASTON Tab Terminals.....	41
Typical Plastic Cavity Pockets.....	42

**Table of Contents**

**AMPLIVAR Splices**

Introduction ..... 44  
 General Application Guidelines ..... 46  
 Suggested Splice Selection Procedure ..... 46  
 Technical Documents ..... 46  
 9 Serrations —Pigtail Type ..... 47  
 7 Serrations —Pigtail Type ..... 47  
 5 Serrations —Thru Type ..... 48  
 5 Serrations —Pigtail Type ..... 49  
 Miniature Splice —Pigtail Type ..... 49

**AMPLIVAR Terminals**

Introduction ..... 50  
 Ring Tongue Terminals ..... 51  
 Stud Retaining Terminals ..... 52  
 Alternator Eyelet Terminal ..... 52  
 125 Series Blade ..... 53  
 187 Series FASTON Tabs ..... 53  
 250 Series FASTON Tabs ..... 53  
 250 Series FASTON Receptacles ..... 64  
 187 Series FASTON Flag Receptacles ..... 55  
 250 Series FASTON Flag Receptacles ..... 55  
 Pin Receptacles ..... 55  
 250 Series Stator Receptacles —7 Serrations ..... 56  
 Stator Terminal —Receptacle .250 x .032 [6.35 x 0.81] ..... 56

**Cluster Blocks**

Introduction ..... 57  
 Cluster Blocks 2.29 [.090] Pin Size (Lead Wire and Direct Connect) ..... 58  
 Cluster Blocks 3.18 [.125] Pin Size (Lead Wire and Direct Connect) ..... 60

**MTM Crimpband Splices - NOT RECOMMENDED FOR NEW DESIGNS**

Introduction ..... 62  
 MTM Crimpband Interconnection System ..... 63  
 11 Serrations ..... 64  
 9 Serrations ..... 64  
 7 Serrations ..... 65

**RTM Crimpband Splices - NOT RECOMMENDED FOR NEW DESIGNS**

Introduction ..... 66  
 RTM Crimpband Interconnection System ..... 67  
 20 Ridges ..... 68  
 14 Ridges ..... 68  
 10 Ridges ..... 68  
 9 Ridges ..... 69  
 8 Ridges ..... 69  
 7 Ridges ..... 69  
 6 Ridges ..... 72  
 3 Ridges ..... 73

**Power Splice**

Introduction ..... 74

---

**Table of Contents**

---

**Application Tooling**

Introduction.....	76
AMPLIVAR Product Terminator (APT) Machine.....	77
Power Splice Machine.....	77
AMPLIVAR Terminator for Parallel and End Connections.....	78
AMP-O-LECTRIC Model G Terminator with Thru-Splice Applicator.....	78
Crimband Application Tooling - <b>NO LONGER AVAILABLE</b> .....	79
MPT-5 MAG-MATE Product Terminator.....	80
MAG-MATE Terminal Cavity and Fixture Design.....	80
MPT-5 S/L Machine for SIAMEZE and Lead Lok Terminals.....	81
EMT -- Entry Level Magnet Wire Terminator.....	81
Manual Hand Tool.....	82
Manual Arbor Press.....	82
Hand Insertion Tools.....	82
Full Line of Crimp Tooling.....	82
MAG-MATE Inserter MK I with Pneumatic Control.....	83
MAG-MATE Inserter MK I with Electro Pneumatic Control.....	83
MAG-MATE and SIAMEZE Inserter MARK II with PLC.....	83
MAG-MATE and SIAMEZE Inserter MARK II with PLC and Insertion Force Control.....	84
Pneumatic Insertion Tool for MAG-MATE Terminals.....	84
Customer Specific Machines.....	85
Custom Built IDC Terminal Insertion Head.....	85
<b>Additional Data</b>	
Technical Information.....	86
Terminal Stud Hole Size.....	90
Part Number Index.....	91

## Standard MAG-MATE Terminals

### Product Facts

- Terminates film-insulated copper and aluminum magnet wire
- Eliminates need for pre-stripping conductors
- Eliminates need to post insulate termination
- Excess magnet wire is automatically trimmed during the termination process
- Simultaneously terminates two magnet wires of the same size in one terminal (for splicing or bi-filing)
- Various lead wire attachment options available
- Available in strip form for semi-automatic or fully automatic insertions
- Available in loose piece form for hand tool insertions
- Varnish resist tab terminals are available for special applications
- High speed, fully automated integrated systems provide uniform terminations reliably at the lowest possible applied cost
- Clean metal-to-metal interface produces stable, gas-tight electrical terminations free of oxides and other contaminants
- Recognized under the Component Recognition Program of Underwriters Laboratories Inc., File No. E13288, Vol. 1, Sec 29



### Applications

- Motor windings and connections
- Coil connections
- Transformer windings and connections
- Bobbin connections
- Lighting ballasts
- Power supplies



TE offers a full selection of Standard MAG-MATE Insulation Displacement Crimp (IDC) terminals for magnet wire terminations.

MAG-MATE terminals are available in poke-in, poke-in tab, splice, crimp wire barrel, solder post, quick connect tab, pin and receptacle styles.

Standard MAG-MATE terminates magnet wire ranging from 34-12 AWG [0.16 -2.05 mm].

Each IDC slot size terminates a range of up to four consecutive magnet wire sizes.



Two magnet wires with the same diameter can be terminated in one terminal except as noted.

According to TE specifications MAG-MATE cavities are either integrated into coil bodies or specially designed cavity housings. The magnet wires are precisely positioned in the plastic cavity slots.

The MAG-MATE Inserter cuts the terminals from the strip and places the terminals over the magnet wire into the plastic cavities.

During this operation, small stripping shoulders in the IDC slot remove the film insulation from the magnet wire.

Wiping action between the wire and terminal removes oxides or other contaminants present on both the conductor and the terminal slot side walls, producing a clean, stable, gas-tight electrical termination.

Residual spring energy in the terminal causes the side walls of each IDC slot to function as opposing cantilever beams.

This constant pressure results in an intimate metal-to-metal interface, providing a reliable, long-term connection.

The MAG-MATE Inserter may be used as a semi-automatic bench machine or integrated into production lines for fully-automatic applications.

\*Contact TE Engineering for guidance regarding aluminum

**Standard MAG-MATE Terminals (Continued)**

**Standard MAG-MATE Interconnection System**

**How the System Operates**

**① Trim Blade**

This part cuts off the excess magnet wire and the wire support at the front of the cavity.

**② Insertion Finger**

The insertion finger is part of the MAG-MATE Inserter. It pushes the terminal that was sheared from the carrier strip through the inserter "tube" into the positioned cavity.

**③ Contact**

Various wire attachments in three different sizes, .187, .300, .500 cavity height (see tables).

**④ IDC Slot**

In different sizes for magnet wire diameters from 34-12 AWG [0.16-2.05 mm]. Strain relief slots available for high vibration applications.

**⑤ Stripping Shoulders**

During the insertion process, these shoulders strip the film insulation from the magnet wire in four areas.

**⑥ Locking Barbs**

Terminal retention is secured in the cavity by four locking barbs.

**⑦ Plastic Cavity**

Integration of plastic cavities into final unit must be in accordance with TE Application Specifications. **Consulting TE is required for design in.**

**⑧ Cavity Slot for Wire**

The width has to be in accordance with the wire size (see Application Specification).

**⑨ Magnet Wire**

The magnet wire is positioned down into the plastic cavity slots.

**⑩ Wire Support Block**

The block supports the magnet wire during the cutting process. The magnet wire is cut flush to the cavity front side.

**⑪ Support Anvil**

The anvil supports the wire during the insertion process.

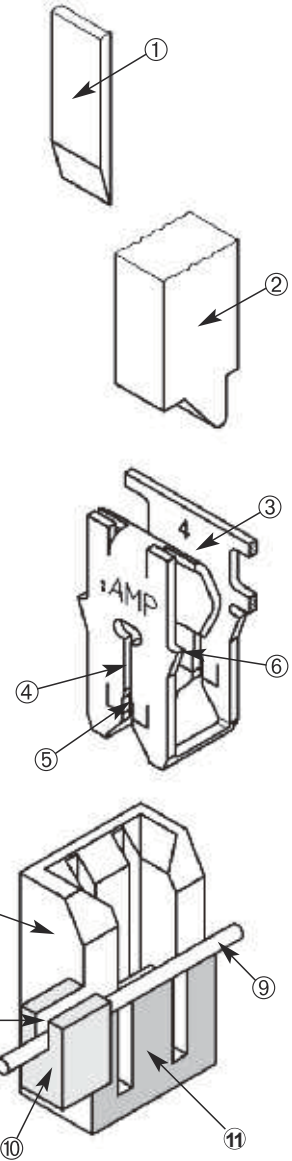

**Termination Sequence**

- A = Prepare
- B = Insert
- C = Finish

- ① Trim Blade
- ② Insertion Finger
- ③ Poke-In Contact
- ④ Plastic Cavity
- ⑤ Magnet Wire
- ⑥ Support Anvil





Standard MAG-MATE Terminals (Continued)

Test Results

Standard and Slim Line

MAG-MATE products have been submitted to the following tests without significant millivolt increase:

Current Cycling—

480 cycles with each cycle consisting of 15 minutes "ON" followed by 15 minutes "OFF"

Thermal Shock—

25 cycles with each cycle consisting of 30 minutes at 125°C followed by 30 minutes at -65°C

Humidity—

Temperature Cycling

10 cycles between 25°C and 65°C at 95% RH

Heat Age—

33 days at 118°C

Mini MAG-MATE

products have been submitted to the following tests in addition to those listed without significant millivolt increase:

Vibration—

10-55-01- Hz traversed in 1 minute at .06 inches total excursion; 2 hours in each of 3 mutually perpendicular directions.

Industrial Gas with Chlorine—

1000 exposure to 200 ppb each of sulphur dioxide, nitrogen dioxide, hydrogen sulphide and 50 ppb chlorine.



Test Current produces 100°C Magnet Wire Operating Temperature



Current Rating Curves

The diagram shows the temperature rise of the contact, depending on the magnet wire size being applied.

Product Specifications

describe technical performance characteristics and verification tests. They are intended for the Design, Test and Quality Engineer.

- 108-2012 Standard .187 and .300 MAG-MATE Terminals
- 108-2053 Standard .500 Box MAG-MATE Terminals
- 108-1484 Slim Line MAG-MATE Terminals
- 108-2016 Mini MAG-MATE Terminals

**Note:** For all applications, TE recommends that samples of the magnet wire to be used be submitted for engineering evaluation.

Standard MAG-MATE Terminals

**Standard MAG-MATE Terminals (Continued)**

**300 Box Poke-In Terminals**

**Material**

Tin plated brass

**Typical Cavity Size 2**

(See page 23)

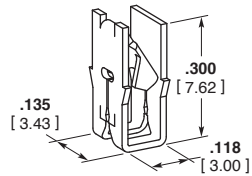

**A**

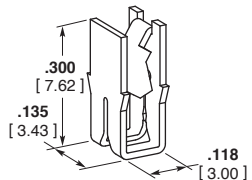

**B**

Type	Copper Magnet Wire Range <sup>1</sup>		Lead Wire Range <sup>3</sup>		Mating <sup>5</sup> Tab	Stock Thickness	Strip Part Number*
	AWG	mm	AWG	mm <sup>2</sup>			
A 300 Box Standard IDC Locking Poke-in	34-33	0.16-0.18	20-18	0.5-0.9	.135 x .020 3.40 x 0.50	.010 0.25	63662-1
	33-31	0.18-0.23	20-18	0.5-0.9	.135 x .020 3.40 x 0.50	.010 0.25	62431-1
	31-28	0.23-0.32	20-18	0.5-0.9	.135 x .020 3.40 x 0.50	.012 0.30	1217234-1
	30-27	0.25-0.36	20-18	0.5-0.9	.135 x .020 3.40 x 0.50	.012 0.30	62429-1
	27-23	0.36-0.57	20-18	0.5-0.9	.135 x .020 3.40 x 0.50	.016 0.41	62935-1
	25-22 <sup>2</sup>	0.45-0.64	20-18	0.5-0.9	.135 x .020 3.40 x 0.50	.016 0.41	63658-1
	22-20 <sup>2</sup>	0.64-0.81	20-18	0.5-0.9	.135 x .020 3.40 x 0.50	.016 0.41	62420-1
	20 <sup>2</sup>	0.81	20-18	0.5-0.9	.135 x .020 3.40 x 0.50	.016 0.41	63591-1
	19-17 <sup>2</sup>	0.91-1.15	20-18	0.5-0.9	.135 x .020 3.40 x 0.50	.016 0.41	62833-1
	B <sup>4</sup> 300 Box Standard IDC w/ Strain Relief Slot Locking Poke-in	30	0.25	20-18	0.5-0.9	.135 x .020 3.40 x 0.50	.012 0.30
29-28		0.29-0.32	20-18	0.5-0.9	.135 x .020 3.40 x 0.50	.012 0.30	1217011-1
28-26		0.32-0.40	20-18	0.5-0.9	.135 x .020 3.40 x 0.50	.012 0.30	1217368-1
27-23		0.36-0.57	20-18	0.5-0.9	.135 x .020 3.40 x 0.50	.016 0.41	63789-1

- 1 Two magnet wires may be terminated in the same terminal slot if diameters are equal.
- 2 Single magnet wire only; 22 AWG [0.64 mm] or larger unless otherwise noted.
- 3 Solid or overcoated stranded lead wire only. Product will also accept Poke-In Tab Terminal shown on page 7.
- 4 Strain relief slot for high vibration applications.
- 5 See page 7 for mating tab options.
- \* Recognized under the Component Program of Underwriters Laboratories, Inc.

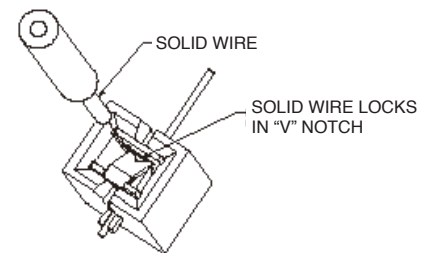
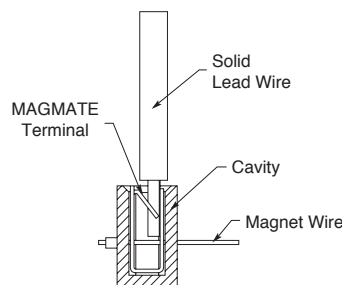
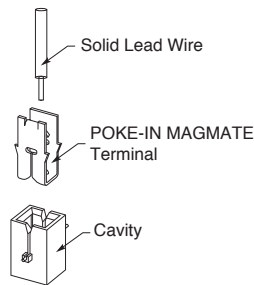

**POKE-IN SYSTEM: SOLID WIRE CONNECTION**

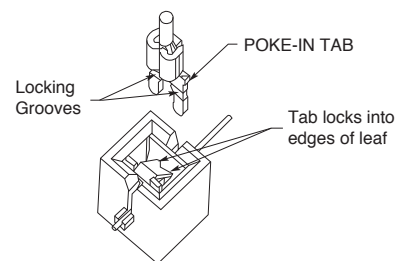
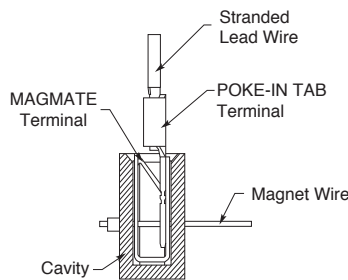
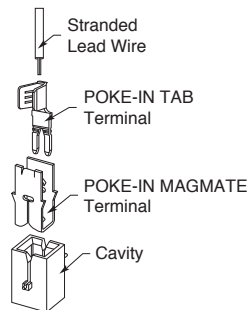

**POKE-IN SYSTEM: STRANDED LEAD WIRE AND POKE-IN TAB CONNECTION**



Standard MAG-MATE Terminals (Continued)



A



B



C



D

Type	Copper Magnet Wire Range <sup>1</sup>		Mating Tab <sup>3</sup>	Stock Thickness	Strip Part Number*
	AWG	mm			
A 300 Box Standard IDC Non-Locking Poke-In MKI	35-32	0.14-0.20	.135 x .020 3.40 x 0.50	.010 0.25	969082-1
	33-30	0.18-0.265	.135 x .020 3.40 x 0.50	.010 0.25	926850-2
	30-26	0.265-0.40	.135 x .020 3.40 x 0.50	.013 0.32	926851-2
	26-21.5 <sup>2</sup>	0.40-0.67	.135 x .020 3.40 x 0.50	.016 0.41	926852-2
	21.5-18.5 <sup>2</sup>	0.67-0.95	.135 x .020 3.40 x 0.50	.016 0.41	928770-2
B 300 Box Standard IDC Non-Locking Poke-In MKII	19.5-17 <sup>2</sup>	0.91-1.13	.135 x .020 3.40 x 0.50	.016 0.41	1-928771-4
	33-30	0.18-0.265	.135 x .020 3.40 x 0.50	.013 0.32	964337-2
	30-26	0.265-0.40	.135 x .020 3.40 x 0.50	.013 0.32	964338-2
	26-22 <sup>2</sup>	0.40-0.63	.135 x .020 3.40 x 0.50	.013 0.32	964339-2
	22-19.5 <sup>2</sup>	0.63-0.85	.135 x .020 3.40 x 0.50	.013 0.32	964340-2
	19.5-17 <sup>2</sup>	0.85-1.12	.135 x .020 3.40 x 0.50	.013 0.32	964341-2
Type	Copper Magnet Wire Range <sup>1</sup>		Feature	Stock Thickness	Strip Part Number
	AWG	mm			
C 433 Box Standard IDC with Receptacle for Tabs	33-30	0.18-0.265	w/o Dimple Dimple	.013 0.32	1-964114-1 964114-1
	30-26	0.265-0.40	w/o Dimple Dimple	.013 0.32	1-964108-1 964108-1
	26-22	0.40-0.63	w/o Dimple Dimple	.013 0.32	1-928854-1 928854-1
	22-19.5 <sup>2</sup>	0.63-0.85	w/o Dimple Dimple	.013 0.32	1-964106-1 964106-1
D 433 Box Standard IDC with Receptacle for Tabs	33-31	0.18-0.265	Dimple	.013 0.32	1740574-1
	26-23	0.40-0.57	w/o Dimple	.013 0.32	964252-1
	22.5 - 20 <sup>2</sup>	0.60-0.80	w/o Dimple	.013 0.32	964110-1
	19-17 <sup>2</sup>	0.90-1.13	w/o Dimple	.013 0.32	964111-1
	19-17 <sup>1</sup>	0.90-1.12	w/o Dimple	.013 0.32	1534234-1

<sup>1</sup> Two magnet wires may be terminated in the same terminal slot if diameters are equal.

<sup>2</sup> Single magnet wire only; 22 AWG [0.64 mm] or larger unless otherwise noted.

<sup>3</sup> See page 7 for mating tab options.

\* Recognized under the Component Program of Underwriters Laboratories, Inc.

Standard MAG-MATE Terminals (Continued)

300 Box Poke-In Terminals

(Continued)

Material

Tin plated brass

Typical Cavity Size 2

(See page 23)

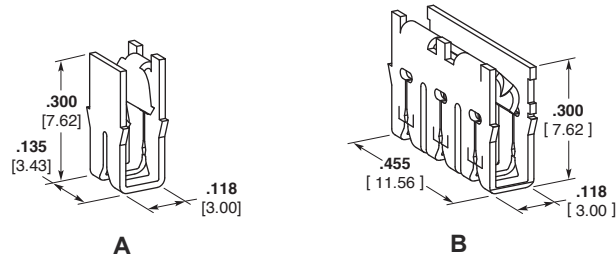

**Note:** Special cavity required for Tri-slot splice terminal. See Application Spec. 114-2046.

Type	Copper Magnet Wire Range <sup>1</sup>		Mating Tab <sup>4</sup>	Stock Thickness	Strip Part Number
	AWG	mm			
A <sup>3</sup> 300 Box Standard IDC w/Strain Relief Slot Non-Locking Poke-In	27-26	0.36-0.40	.135 x .020 3.40 x 0.50	.016 0.41	1217691-1
	25.5-24	0.43-0.51	.135 x .020 3.40 x 0.50	.016 0.41	1217690-1
	23.5-22 <sup>2</sup>	0.54-0.64	.135 x .020 3.40 x 0.50	.016 0.41	1217689-1
	21.5-20 <sup>2</sup>	0.68-0.81	.135 x .020 3.40 x 0.50	.016 0.41	1217688-1
B 300 Box Standard IDC Non-Locking Poke-In	30-27	0.25-0.36	.135 x .020 3.40 x 0.50	.016 0.41	1217221-1
	27-23	0.36-0.57	.135 x .020 3.40 x 0.50	.016 0.41	63632-1
	23-20 <sup>2</sup>	0.57-0.81	.135 x .020 3.40 x 0.50	.016 0.41	1217533-1
	19-17	0.91-1.15	.135 x .020 3.40 x 0.50	.016 0.41	1742347-1
	27-23 <sup>2</sup> 19-17 <sup>2</sup> 18 <sup>2</sup>	0.36-0.57 0.91-1.15 0.8-0.9	.135 x .020 3.40 x 0.50	.016 0.41	63975-1

- 1 Two magnet wires may be terminated in the same terminal slot if diameters are equal.
- 2 Single magnet wire only; 22 AWG [0.64 mm] or larger.
- 3 Strain relief slot for high vibration applications.
- 4 See page 7 for mating small tab options.

\* Recognized under the Component Program of Underwriters Laboratories, Inc.

500 Box Poke-In Terminals

Material

Tin plated brass

Typical Cavity Size 4

(See page 23)

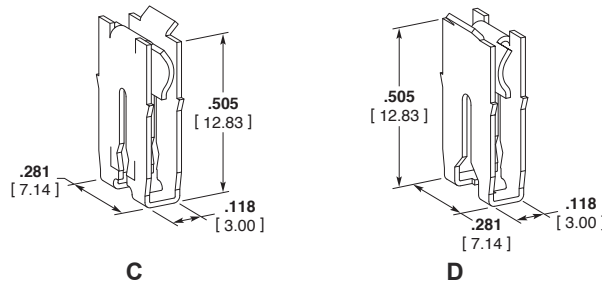

**Note:** Mating poke-in tab

1217324-1

(See Type H, Page 7)

Type	Copper Magnet Wire Range <sup>1</sup>		Stock Thickness	Strip Part Number
	AWG	mm		
C 500 Box Standard IDC Non-Locking Poke-In	23-19.5	0.57-0.86	.016 0.41	1217069-1
	19-17	0.91-1.15	.016 0.41	1217068-1
	16-15	1.29-1.45	.016 0.41	1217067-1
D <sup>3</sup> 500 Box Standard IDC w/ Strain Relief Slot Non-Locking Poke-In	23-21.5	0.57-0.68	.016 0.41	1217358-1
	21-19.5	0.72-0.86	.016 0.41	1217357-1
	19-17	0.91-1.15	.016 0.41	1217356-1
	17-16	1.15-1.29	.016 0.41	1742203-1
	16-15	1.29-1.45	.016 0.41	1217355-1
	14-13 <sup>2</sup>	1.61-1.83	.016 0.41	1217579-1

- 1 Two magnet wires may be terminated in the same terminal slot if diameters are equal.
- 2 Single magnet wire only.
- 3 Strain relief slot for high vibration applications.

Standard MAG-MATE Terminals (Continued)

Poke-In Tab Terminals

Material

Tin plated brass

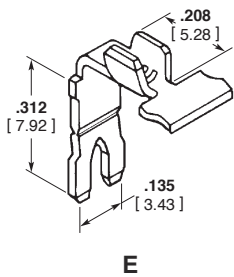

Type	Lead Wire Size <sup>1</sup>		Ins. O.D.	Stock Thickness	Strip Part Number	
	AWG	mm <sup>2</sup>				
A 90° Up	22-18	0.3-0.9	—	.018	62895-1*	
				0.46	63410-1	
B 90° Up w/Ins. Sup.	24	0.2	.040-.060	.018	1742828-1	
			1.02-1.52	0.46		
			.060-.100	.018	62896-1*	
C Straight	18-14	0.8-2.0	—	.090-.140	.018	63218-1
				2.29-3.56	0.46	
D Straight w/Ins. Sup.	22-18	0.3-0.9	—	.020	62897-1*	
				0.51	63775-1	
				.060-.100	.020	62898-1*
				1.52-2.54	0.51	
E 90° Down	18-14	0.8-2.0	—	.090-.140	.020	63397-1
				2.29-3.56	0.51	
				.118 MAX.	.018	281622-2 <sup>2</sup>
				3.00 MAX.	0.45	
E 90° Down	22-17	0.3-1.0	—	.118 MAX.	.018	281623-2 <sup>2</sup>
				3.00 MAX.	0.45	
E 90° Down	20-17	0.5-1.0	—	.063-.090	.018	964101-2 <sup>3</sup>
				1.60-2.30	0.45	
E 90° Down	20-17	0.5-1.0	—	.063-.090	.018	964290-1 <sup>4</sup>
				1.60-2.30	0.45	
E 90° Down	22-18	0.3-0.9	—	.018	63364-1	
				0.46	1742125-1	
E 90° Down	18-14	0.8-2.0	—	.018		
				0.46		

1 Stranded, fused stranded or solid lead wire.

2 Can be selectively bent inside applicator. With support flanges, can only be used in combination with modified cavity IA-84-5157

3 Can be selectively bent inside applicator, Non-locking

4 Can be selectively bent inside applicator. Non-locking; use with housing

\* Recognized under the Component Program of Underwriters Laboratories, Inc.

Note: All tab terminals accept stranded, fused stranded or solid lead wire.

Standard MAG-MATE Terminals

Standard MAG-MATE Terminals (Continued)

Poke-In Tab Terminals

Material

Tin plated brass  
Pre-Tin plated brass



K



L



F



I



J

Type	Lead Wire Size <sup>1</sup>		Ins. O.D.	Stock Thickness	Strip Part Number
	AWG	mm <sup>2</sup>			
F 90° Down w/Ins. Sup.	24-20	0.2-0.5	.048-.078 1.22-1.98	.020 0.51	1742410-1
	22-18	0.3-0.9	.060-.100 1.52-2.54	.020 0.51	1742211-1
	18-14	0.8-2.0	.090-.140 2.29-3.56	.020 0.51	63458-1
Flag - 300 Box only	20-16	0.5-1.4	—	.020 0.51	1217406-1
Flag - 500 Box only	18-14	0.8-2.0	.080-.120 2.03-3.05	.020 0.51	1217324-1
K Bridge Contact	—	—	—	.020 0.51	1987199-1
L PCB Contact	—	—	—	.020 0.51	1217041-1

Note: All tab terminals accept stranded, fused stranded or solid lead wire.

MAG-MATE Terminals with extended leaf-spring

Material

Pre-tinned copper alloy



M

Type	Copper Magnet Wire Range		Stock Thickness	Strip Part Number
	AWG	mm		
M Mag-Mate Terminal with extended Leaf-Spring	33-30	0.18-0.265	.013 0.32	1740603-1
	30-26	0.265-0.40	.013 0.32	1740698-2
	26.5-22.5	0.375-0.60	.013 0.32	1534110-1
	22.5-20	0.60-0.80	.013 0.32	969125-1*
	19.5-17	0.85-1.12	.013 0.32	1418686-1

\*Single magnet wire

Note: Special cavity is required, contact TE connectivity for information.

Standard MAG-MATE Terminals (Continued)

300 Box Poke-In Terminals

Material

Tin plated brass

.300 [7.62] Series Box

Typical Cavity Size 2

(See page 23)

**Note:** Special cavity required for  
Tri-slot splice terminal.  
See application  
SPEC 114-2046



Type	Copper Magnet Wire Range <sup>1</sup>		Stock Thickness	Strip Part Number
	AWG	mm		
A 300 Box Standard IDC Splice	22-20	0.64-0.81	.016 0.41	1217973-1
	19-17	0.91-1.15	.020 0.51	1742159-1 <sup>4</sup>
	28-24	0.32-0.51	.016 0.41	1217858-1
B 300 Box Standard IDC Tri-Slot Splice	23-20 <sup>2</sup>	0.57-0.81	.016 0.41	1217853-1
	27-23	0.36-0.57		
	18 <sup>4</sup>	0.8-0.9	.016 0.41	1217613-1
	19-17 <sup>2</sup>	0.91-1.15		
	25-22 <sup>3</sup>	0.45-0.64		
	18 <sup>4</sup>	0.8-0.9	.016 0.41	1217209-1
	23.5-20 <sup>2</sup>	0.54-0.81		

1 Two magnet wires may be terminated in the same terminal slot if diameters are equal.  
2 Single magnet wire only; 22 AWG [0.64 mm] or larger.  
3 Single solid or fused stranded lead wire only.  
4 Special cavity required for 1742159-1.

Tab Receptacle Terminals

Material

Tin plated phos. bronze

**Note:** Special cavity required.  
Contact TE Engineering for  
details.



Type	Copper Magnet Wire Range <sup>1</sup>		Mating Tab	Stock Thickness	Strip Part Number
	AWG	mm			
C 185 Box Standard IDC Tab Receptacle	32-31	0.20-0.23	.070 x .020 1.78 x 0.51	.010 0.25	1217538-1
	30-28	0.25-0.32	.070 x .020 1.78 x 0.51	.010 0.25	1217457-1
	29-28	0.29-0.32	.070 x .020 1.78 x 0.51	.010 0.25	1217458-1
	28-27	0.32-0.36	.070 x .020 1.78 x 0.51	.010 0.25	1742781-1

1 Two magnet wires may be terminated in the same slot if diameters are equal.

Standard MAG-MATE Terminals (Continued)

187 Box F-Crimp Terminals

Material

Tin plated brass

.187 [4.75] Series Box

Typical Cavity Size 1

(See page 23)



Type	Copper Magnet Wire Range <sup>1</sup>		Lead Wire Range <sup>3</sup>		Ins. O.D.	Stock Thickness	Strip Part Number
	AWG	mm	AWG	mm <sup>2</sup>			
A 187 Box Standard IDC F-Crimp	33-31	0.18-0.23	26-22	0.12-0.3	—	.010 0.25	63039-1
	30-28	0.25-0.32	26-22	0.12-0.3	—	.012 0.30	63036-1
	27-25	0.36-0.46	26-22	0.12-0.3	—	.012 0.30	62609-1 <sup>4</sup>
	26-24	0.40-0.51	22-18	0.3-1.0	—	.012 0.30	1217146-1
	24-22 <sup>2</sup>	0.51-0.64	26-22	0.12-0.3	—	.012 0.30	62610-1 <sup>4</sup>
B 187 Box F-Crimp w/Ins Sup.	27-25	0.36-0.46	22-18	0.3-1.0	.071-.088 1.80-2.23	.012 0.30	63856-1

- 1 Two magnet wires may be terminated in the same terminal slot if diameters are equal.
- 2 Single magnet wire only.
- 3 Stranded, fused stranded or solid lead wire.
- 4 Strip rereeled to feed through mini-applicator to crimp lead wire first, magnet wire termination is secondary operation.

300 Box F-Crimp Terminals

Material

Tin plated brass

.300 [7.62] Series Box

Typical Cavity Size 2, when "C" dimension is .120 [3.05]

(See page 23)

Typical Cavity Size 6, when "C" dimension is .070 [1.78]

(See page 23)

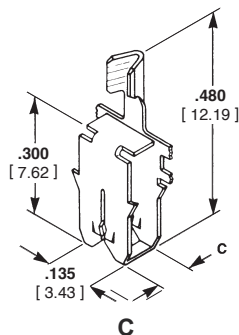

Type	Copper Magnet Wire Range <sup>1</sup>		Dim. C	Lead Wire Range <sup>3</sup>		Stock Thickness	Strip Part Number
	AWG	mm		AWG	mm <sup>2</sup>		
C 300 Box Standard IDC F-Crimp	33-31	0.18-0.23	.070 1.78	22-18	0.3-1.0	.012 0.30	63235-1
			.120 3.05	24-20	0.2-0.6	.012 0.30	63420-1
	31-28	0.23-0.32	.070 1.78	22-18	0.3-1.0	.012 0.30	63236-1
			.070 1.78	24-20	0.2-0.6	.012 0.30	1742614-1
	30-27	0.25-0.36	.120 3.05	24-20	0.2-0.6	.012 0.30	62992-1
	28-24	0.32-0.51	.120 3.05	24-20	0.2-0.6	.012 0.30	63641-1
	27-24	0.36-0.51	.070 1.78	22-18	0.3-1.0	.012 0.30	63237-1
	27-23	0.36-0.57	.120 3.05	24-20	0.2-0.6	.016 0.41	62459-1
	25-22	0.45-0.64	.070 1.78	22-18	0.3-1.0	.012 0.30	63690-1
	22-20 <sup>2</sup>	0.64-0.81	.120 3.05	24-20	0.2-0.6	.016 0.41	62458-1
	19-17 <sup>2</sup>	0.91-1.15	.120 3.05	22-18	0.3-1.0	.016 0.41	63504-1

- 1 Two magnet wires may be terminated in the same terminal slot if diameters are equal.
- 2 Single magnet wire only; 22 AWG [0.64 mm] or larger.
- 3 Stranded, fused stranded or solid lead wire.



Standard MAG-MATE Terminals (Continued)

**300 Box Posted PCB Terminals**

**Multi-Spring Solderless Terminal**

**Material**

Tin over Copper Alloy

**Cavity Size**

Application Spec.  
114-74109 with 114-74109-5



Type	Copper Magnet Wire Range <sup>1</sup>		Dim L	Stock Thickness		Strip Part Number
	AWG	mm		Tab Section	Mag Wire Section	
A Multi-Spring Solderless PCB Tab Terminal	33-29.5	0.18-0.265	.583	.031	.013	1247000-2
			14.80	0.80	0.32	
	29.5-26	0.265-0.40	.583	.031	.013	1247001-2
			14.80	0.80	0.32	
	26-22.5	0.40-0.63	.583	.031	.013	1247002-2
14.80			0.80	0.32		
22.5-19.5 <sup>2</sup>	0.63-0.85	.583	.031	.013	1247003-2	
		14.80	0.80	0.32		
19.5-17 <sup>2</sup>	0.85-1.12	.583	.031	.013	1247004-2	
		14.80	0.80	0.32		

1 Two magnet wires may be terminated in the same terminal slot if diameters are equal.  
2 Single magnet wire only. 22 awg [0.63 mm] and larger.

Note: PC Board hole size .057 [1.45].

**300 Box Posted PCB Terminals Solder Terminal**

**Material**

Tin over copper plated brass

**Typical Cavity Size**

(See page 23)  
Type C—Cavity Size 2  
Type D—Cavity Size 6

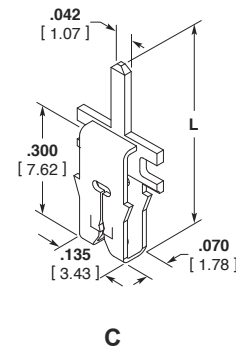

Type	Copper Magnet Wire Range <sup>1</sup>		Dim. L	Stock Thickness		Strip Part Number
	AWG	mm		Tab Section	Mag Wire	
B 300 Box Standard IDC PCB Post	33-31	0.18-0.23	.540	.010	.010	63253-1
			13.72	0.25	0.25	
	31-28	0.23-0.32	.540	.010	.010	62928-1*
			13.72	0.25	0.25	
	29-26	0.29-0.40	.540	.012	.012	62958-1*
			13.72	0.30	0.30	
	27-23	0.36-0.57	.460	.016	.016	63659-1
11.68			0.41	0.41		
22-20 <sup>2</sup>	0.64-0.81	.460	.016	.016	63660-1	
		11.68	0.41	0.41		
19-17 <sup>2</sup>	0.91-1.15	.460	.016	.016	63661-1	
		11.68	0.41	0.41		
19-17 <sup>2</sup>	0.91-1.15	.570	.016	.016	1742708-1	
		14.48	0.41	0.41		
C PCB Post Shallow Box	33-31	0.18-0.23	.475	.020	.012	1217302-1
			12.07	0.51	0.30	

1 Two magnet wires may be terminated in the same terminal slot if diameters are equal.

2 Single magnet wire only.

\* Recognized under the Component Program of Underwriters Laboratories, Inc.

Note: PC Board hole size .050 [1.27].

**Standard MAG-MATE Terminals (Continued)**

**MAG-MATE  
Edge Leaf Terminal**

**Material**

Pre-tinned brass  
Brass

**Cavity**

411-18517

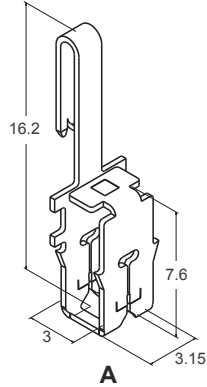

	Copper Magnet Wire Range		Cavity Size	Stock Thickness	Strip Part Number
	AWG	mm			
A MAG-MATE Contact RAST 5D	33-30	0.18-0.265	2	.013 0.32	1394429-2
	30-26	0.265-0.40	2	.013 0.32	1394430-2
	26-22	0.40-0.63	2	.013 0.32	1394431-2
	22-20	0.63-0.80	2	.013 0.32	1394432-2
	20-17	0.85-1.12	2	.013 0.32	1394433-2

**Note:** Special cavity required. Contact TE Connectivity for information

**Material**

Unplated brass

**Cavity**

411-18517



Type	Copper Magnet Wire Range		Cavity Size	Stock Thickness	Strip Part Number
	AWG	mm			
B MAG-MATE Edge Leaf Contact	33-30	0.18-0.265	2	.013 0.32	1-1987143-1

**Note:** Special cavity required. Contact TE Connectivity for information

Standard MAG-MATE Terminals (Continued)

187 Box Posted PCB Terminals

Material

Tin plated brass

Typical Cavity Size 1

(See page 23)

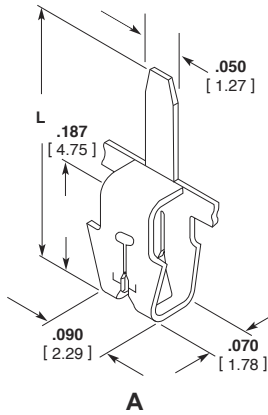

A

Type	Copper Magnet Wire Range <sup>1</sup>		Dim. L	Stock Thickness		Strip Part Number
	AWG	mm				
A 185 Box Standard IDC PCB Post	33-31	0.18-0.23	.267	.010	63565-1	
			6.78	0.25		
	30-28	0.25-0.32	.330	.010	62938-1	
			8.38	0.25		
			.267	.012	63160-1	
			6.78	0.30		
27-25	0.36-0.46	.287	.012	63818-1		
		7.29	0.30			
24-22 <sup>2</sup>	0.51-0.64	.330	.012	62430-1		
		8.38	0.30			
		.287	.012	63819-1		
		7.29	0.30			
		.330	.012	62439-1		
		8.38	0.30			

1 Two magnet wires may be terminated in the same terminal slot if diameters are equal.  
2 Single magnet wire only.

187 Box Tab Terminals

Material

Tin plated brass

Typical Cavity Size 1

(See page 23)

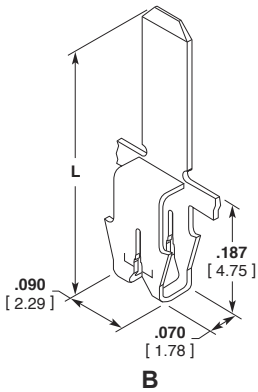

B

Type	Copper Magnet Wire Range <sup>1</sup>		Dim. L	Tab Size	Stock Thickness		Strip Part Number
	AWG	mm			Tab Section	Mag Wire	
	30-28	0.25-0.32	.432	.110 x .020	.020	.012	63702-1
			10.97	2.79 x 0.51	0.51	0.30	
	29-27	0.29-0.36	.432	.110 x .020	.020	.012	1217196-1
			10.97	2.79 x 0.51	0.51	0.30	
B 187 Box Standard IDC F-Crimp	30-28	0.25-0.32	.512	.110 x .020	.020	.012	160810-2
			13.00	2.79 x 0.51	0.51	0.30	
	27-25	0.25-0.32	.512	.110 x .020	.020	.012	160809-2
			13.00	2.79 x 0.51	0.51	0.30	
	24-22	0.25-0.32	.512	.110 x .020	.020	.012	160897-2
			13.00	2.79 x 0.51	0.51	0.30	
	30	0.25	.550	.071 x .025	.025	.012	1217405-1
			14.00	1.80 x 0.63	0.63	0.30	
	29-27	0.29-0.36	.700	.059 x .032	.032	.012	1742605-1
			17.78	1.50 x 0.81	0.81	0.30	
	25-22 <sup>2</sup>	0.46-0.64	.700	.059 x .032	.032	.012	1217013-1
			17.78	1.50 x 0.81	0.81	0.30	

1 Two magnet wires may be terminated in the same terminal if diameters are equal.  
2 Single magnet wire only.

Standard MAG-MATE Terminals

Standard MAG-MATE Terminals (Continued)

300 Box Tab Terminals

Material

Tin plated brass

Typical Cavity Size 2

(See page 23)

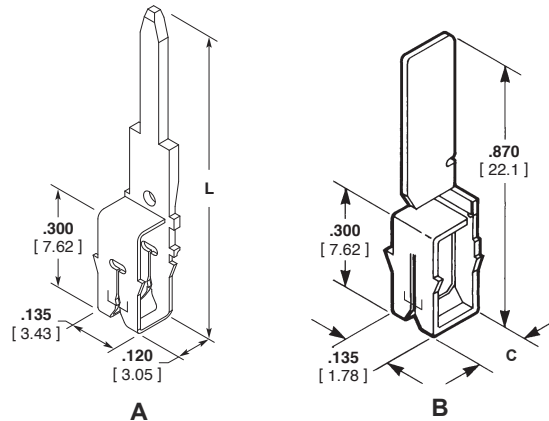

Type	Copper Magnet Wire Range <sup>1</sup>		Dim. L	Tab Size	Stock Thickness		Strip Part Number
	AWG	mm			Tab Section	Mag Wire	
A 300 Box Standard IDC Straight Tab	20	0.79	.750	.063 x .025	.025	.016	63965-1 <sup>2</sup>
			19.05	1.60 x 0.63	0.63	0.41	
	31	0.23	.895	.063 x .025	.025	.016	1217595-1 <sup>2</sup>
			22.73	1.60 x 0.63	0.63	0.41	
			.870	.062 x .032	.032	.010	63810-1
			22.10	1.57 x 0.81	0.81	0.25	

1 Two magnet wires may be terminated in the same terminal slot if diameters are equal.  
2 Tinsel wire only.

Typical Cavity Size 2  
when "C" dimension is .120[3.05]  
(See page 23)  
Typical Cavity Size 6  
when "C" dimension is .070[1.78]  
(See page 23)

Type	Copper Magnet Wire Range <sup>1</sup>		Dim. C	Tab Size	Stock Thickness		Strip Part Number
	AWG	mm			Tab Section	Mag Wire	
B 300 Box Standard IDC Twisted Tab	33-31	0.18-0.23	.070	.125 x .020	.020	.012	63806-1
			1.78	3.17 x 0.51	0.51	0.30	
	31-28	0.23-0.32	.070	.125 x .020	.020	.012	63807-1
			1.78	3.17 x 0.51	0.51	0.30	
	27-24	0.36-0.50	.070	.125 x .020	.020	.012	63808-1
1.78			3.17 x 0.51	0.51	0.30		
21 <sup>2</sup>	0.72	.120	.118 x .030	.030	.016	63463-1	
			3.05	3.00 x 0.76	0.76	0.41	
			.120	.118 x .030	.030	.016	63216-1
			3.05	3.00 x 0.76	0.76	0.41	

1 Two magnet wires may be terminated in the same terminal slot if diameters are equal.  
2 Single magnet wire only.

Material

Tin plated brass

Typical Cavity Size 2

(See page 23)

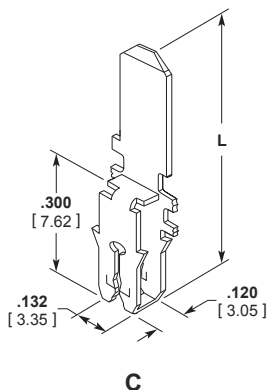

Type	Copper Magnet Wire Range <sup>1</sup>		Dim. L	Tab Size	Stock Thickness		Strip Part Number	
	AWG	mm			Tab Section	Mag Wire		
C 300 Box Standard IDC Timer Tab	33-31	0.18-0.23	.585	.118 x .020	.020	.010	1217746-1	
			14.86	3.00 x 0.51	0.51	0.25		
	30 -28	0.25-0.32	.585	.118 x .020	.020	.010	1217745-1	
			14.86	3.00 x 0.51	0.51	0.25		
	27-23	0.36-0.57	.585	.118 x .020	.020	.016	63973-1	
			14.86	3.00 x 0.51	0.51	0.41		
				.585	.125 x .020	.020	.016	63489-1
				14.86	3.17 x 0.51	0.51	0.41	
	25-22 <sup>2</sup>	0.45-0.64		.585	.118 x .020	.020	.016	1217596-1
				14.86	3.00 x 0.51	0.51	0.41	
	23.5-21.5 <sup>2</sup>	0.54-0.68		.585	.118 x .020	.020	.016	1217593-1
				14.86	3.00 x 0.51	0.51	0.41	
27-23	0.36-0.57		.775	.125 x .020	.020	.016	1742167-1	
			19.68	3.17 x 0.51	0.51	0.41		
23-20 <sup>2</sup>	0.57-0.81		.775	.125 x .020	.020	.016	63899-1	
			19.68	3.17 x 0.51	0.51	0.41		
19-17 <sup>2</sup>	0.91-1.15		.585	.118 x .020	.020	.016	63972-1	
			14.86	3.00 x 0.51	0.51	0.41		
18 Lead	1.02		.585	.118 x .020	.020	.016	63974-1	
			14.86	3.00 x 0.51	0.51	0.41		

1 Two magnet wires may be terminated in the same terminal slot if diameters are equal.  
2 Single magnet wire only; 22 AWG [0.64 mm] or larger.

Standard MAG-MATE Terminals (Continued)

Pin Receptacle Terminals

Material

A: Tin plated brass  
 B: Unplated brass

Typical Cavity Size 2  
 (See page 23)

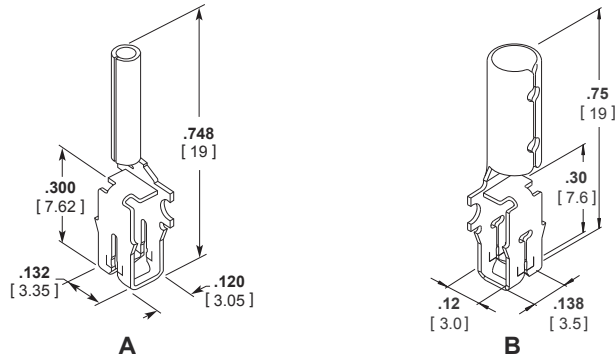

Standard MAG-MATE Terminals

Type	Copper Magnet Wire Range <sup>1</sup>		Mating Pin Dia.	Stock Thickness	Strip Part Number
	AWG	mm			
A Pin Receptacle	30-27	0.25-0.36	.079 2.00	.013 0.32	1394403-1
	26-23	0.40-0.57	.079 2.00	.013 0.32	1394475-1
	21-18 <sup>2</sup>	0.72-1.00	.079 2.00	.013 0.32	1394476-1
	26-23	0.40-0.57	.150 3.80	.013 0.32	1394638-1
	21-18 <sup>2</sup>	0.72-1.00	.150 3.80	.013 0.32	1394639-1
B Pin Receptacle	30-27	0.25-0.36	.150 3.80	.013 0.32	1740417-1
	26-23	0.40-0.57	.150 3.80	.013 0.32	1740418-1
	21-18 <sup>3</sup>	0.72-1.00	.150 3.80	.013 0.32	1740419-1

1 Two magnet wires may be terminated in the same terminal slot if diameters are equal.  
 2 Single magnet wire only; 20.5 AWG [0.76 mm] or larger.  
 3 Single magnet wire only

Standard MAG-MATE Terminals (Continued)

Pin I/O Terminals

Material

Tin plated brass

**.300 [7.62] Series Box**

Styles A, B and C

Typical Cavity Size 2

(See page 23)

**.500 [12.7] Series Box**

Style D

Typical Cavity Size 4

(See page 23)



A



B

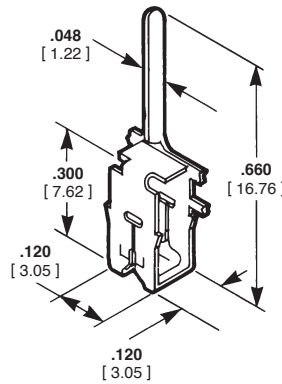

C



D

Type	Copper Magnet Wire Range <sup>1</sup>		Pin Dia.	Stock Thickness		Strip Part Number
	AWG	mm		I/O	Mag Wire	
A 300 Box Straight Pin	27-23	0.36-0.57	.060 1.52	.010 0.25	.010 0.25	63722-1
B 300 Box Offset Pin-R.H.	33-31	0.18-0.23	.048 1.22	.010 0.25	.010 0.25	63443-1
	33-31	0.18-0.23	.048 1.22	.010 0.25	.010 0.25	63444-1
C 300 Box Offset Pin-L.H.	31-28	0.23-0.32	.048 1.22	.010 0.25	.010 0.25	63569-1
	27-23	0.36-0.57	.048 1.22	.010 0.25	.016 0.25	63570-1
	25-22 <sup>2</sup>	0.45-0.64	.048 1.22	.010 0.25	.016 0.41	63788-1
D 500 Box Straight Pin	27-23	0.86-1.15	.090 2.29	.016 0.41	.016 0.41	63278-1
	22-20	0.64-0.81	.090 2.29	.016 0.41	.016 0.41	63277-1

<sup>1</sup> Two magnet wires may be terminated in the same terminal slot if diameters are equal.

<sup>2</sup> Single magnet wire only; 22 AWG [0.64 mm] or larger.



Standard MAG-MATE Terminals (Continued)

110 Series  
FASTON Tab Terminals

Material

Tin plated brass

Typical Cavity Size 2

(See page 23)

Note: .110 [2.79] Tab Terminals

mate with compatible

FASTON receptacles.

Request Catalog 82004.

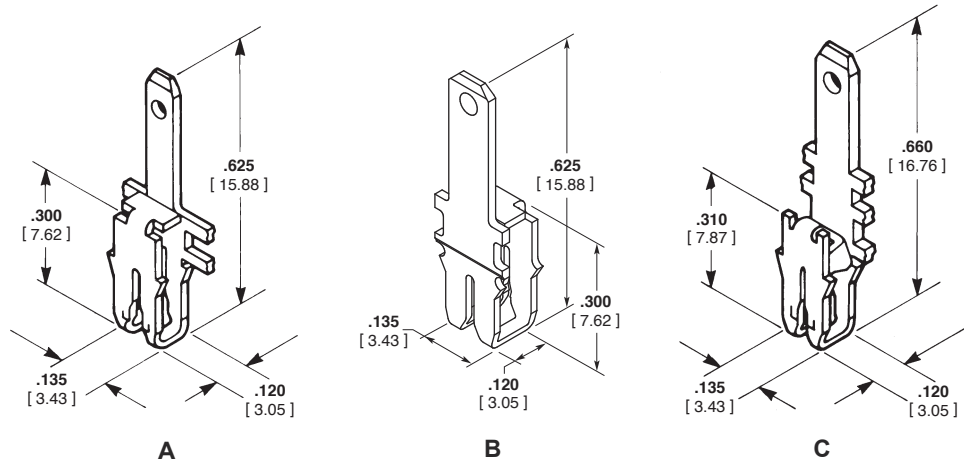

Type	Copper Magnet Wire Range <sup>1</sup>		Tab Size	Stock Thickness		Strip Part Number
	AWG	mm		Tab	Mag Wire	
A <sup>4</sup> 300 Box Standard IDC .110[2.79] FASTON Tab	30-27	0.25-0.36	.110 x .020 2.79 x 0.51	.020 0.51	.012 0.30	63777-1
	27-23	0.36-0.57	.110 x .020 2.79 x 0.51	.020 0.51	.016 0.41	63746-1
	23-20 <sup>2</sup>	0.45-0.64	.110 x .020 2.79 x 0.51	.020 0.51	.016 0.41	63486-1
B <sup>4,5</sup> 300 Box Single IDC w/ Strain Relief Slot	19-17	0.91-1.15	.110 x .020 2.79 x 0.51	.020 0.51	.020 0.51	63145-1
	27-23	0.36-0.57	.110 x .020 2.79 x 0.51	.020 0.51	.016 0.41	63827-1
C <sup>3,4</sup> Poke-In Combination Tab	3.5-20 <sup>2</sup>	0.54-0.81	.110 x .020 2.79 x 0.51	.020 0.51	.016 0.41	1217783-1
	28-24	0.32-0.51	.110 x .020 2.79 x 0.51	.020 0.51	.012 0.30	63062-1
	25-22 <sup>2</sup>	0.45-0.64	.110 x .020 2.79 x 0.51	.020 0.51	.012 0.30	63063-2

1 Two magnet wires may be terminated in the same terminal slot if diameters are equal.

2 Single magnet wire only; 22 AWG [0.64 mm] or larger.

3 Poke-In feature accepts 20-18 AWG [0.5-0.8 mm<sup>2</sup>] Solid or overcoated stranded lead wire or 90° Poke-In tab.

4 After insertion into plastic cavity, tab portion must be bent over 45°-90° or potted in to prevent pullout when mating receptacle is disconnected.

5 Strain relief slot for high vibration applications.

**Standard MAG-MATE Terminals (Continued)**

**187 Series FASTON Tab Terminals**

**Material**

Tin plated brass

**Typical Cavity Size**

(See page 23)

Type A—Cavity Size 2

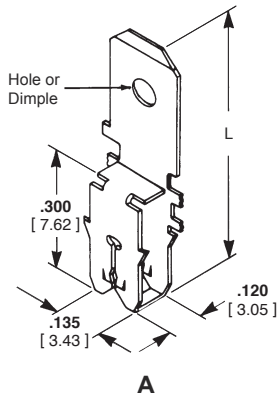

A<sup>3</sup>  
300 Box  
Standard IDC  
.187 [4.75]  
FASTON  
Tab

Type	Copper Magnet Wire Range <sup>1</sup>		Dim. L	Tab Feature	Tab Size	Stock Thickness		Strip Part Number
	AWG	mm				Tab Section	Mag. Wire Section	
33-31	0.18-0.23	.630 16.00	.630 16.00	Dimple	.187 x .020 4.75 x 0.51	.020 0.51	.010 0.25	62513-1*
				Hole	.187 x .020 4.75 x 0.51	.020 0.51	.012 0.30	63584-1
30-27	0.25-0.36	.630 16.00	.630 16.00	Dimple	.187 x .020 4.75 x 0.51	.020 0.51	.012 0.30	62512-1*
				Dimple	.187 x .032 4.75 x 0.81	.032 0.81	.012 0.30	62678-1†*
27-23	0.36-0.57	.630 16.00	.630 16.00	Dimple	.187 x .020 4.75 x 0.51	.020 0.51	.016 0.41	62514-1*
				Hole	.187 x .020 4.75 x 0.51	.020 0.51	.016 0.41	63664-1
23	0.57	.630 16.00	.630 16.00	—	.187 x .020 4.75 x 0.51	.020 0.51	.016 0.41	63776-1
				Hole	.187 x .020 4.75 x 0.51	.020 0.51	.016 0.41	63585-1
22-20 <sup>2</sup>	0.64-0.81	.630 16.00	.630 16.00	Dimple	.187 x .020 4.75 x 0.51	.020 0.51	.016 0.41	62511-1*
				Hole	.187 x .020 4.75 x 0.51	.020 0.51	.016 0.41	63663-1
20-18 <sup>2</sup>	0.81-1.02	.630 16.00	.630 16.00	Dimple	.187 x .032 4.75 x 0.81	.032 0.81	.016 0.41	1217065-1
				Hole	.187 x .032 4.75 x 0.81	.032 0.81	.016 0.41	1217128-1
19-17	0.91-1.15	.630 16.00	.630 16.00	Dimple	.187 x .020 4.75 x 0.51	.020 0.51	.020 0.51	62904-1 <sup>4</sup>
				Hole	.187 x .020 4.75 x 0.51	.020 0.51	.020 0.51	63670-1
19-17	0.91-1.15	.630 16.00	.630 16.00	Dimple	.187 x .020 4.75 x 0.51	.020 0.51	.020 0.51	63273-1 <sup>2</sup>
				Hole	.187 x .020 4.75 x 0.51	.020 0.51	.020 0.51	1742160-1 <sup>1</sup>

**187 Series Combination Poke-In FASTON Terminals**

**Material**

Tin plated brass

**Typical Cavity Size**

(See page 23)

Type B—Cavity Size 2

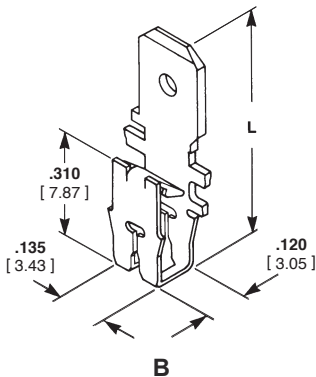

B<sup>3,4</sup>  
Poke-In  
Combination  
Tab

Type	Copper Magnet Wire Range <sup>1</sup>		Dim. L	Tab Feature	Tab Size	Stock Thickness		Strip Part Number
	AWG	mm				Tab Section	Mag. Wire Section	
33-31	0.81-0.23	.630 16.00	.630 16.00	Hole	.187 x .020 4.75 x 0.51	.020 0.51	.010 0.25	63018-1
27-22 <sup>2</sup>	0.35-0.63	.630 16.00	.630 16.00	w/o Hole	.187 x .020 4.75 x 0.51	.020 0.51	.016 0.41	316300-4 2-316300-7
22-19 <sup>2</sup>	0.64-0.89	.630 16.00	.630 16.00	w/o Hole	.187 x .020 4.75 x 0.51	.020 0.51	.016 0.41	316300-5 2-316300-8
19-17 <sup>2</sup>	0.90-1.15	.630 16.00	.630 16.00	w/o Hole	.187 x .020 4.75 x 0.51	.020 0.51	.016 0.41	316300-6 2-316300-9
17-16 <sup>2</sup>	1.20-1.30	.630 16.00	.630 16.00	Hole	.187 x .020 4.75 x 0.51	.020 0.51	.016 0.41	6-316300-7

- 1 Two magnet wires may be terminated in the same terminal slot if diameters are equal.
- 2 Single magnet wire only.
- 3 After insertion into plastic cavity, tab portion must be bent over 45°-90° or potted in to prevent pullout when mating receptacle is disconnected.
- 4 Single bare copper wire only.

\* Recognized under the Component Program of Underwriters Laboratories, Inc.

† These part numbers are available upon special request; contact TE Engineering for details.

**Note:** 187 [4.75] Tab Terminals mate with compatible FASTON receptacles. Request Catalog 82004.

Chart continued on next page

Standard MAG-MATE Terminals (Continued)

**187 Series  
FASTON Tab Terminals**

(Continued)

**Material**

Tin plated brass

**Typical Cavity Size**

(See page 23)

Type A—Cavity Size 5

Type B—Cavity Size 5



Standard MAG-MATE  
Terminals

Type	Copper Magnet Wire Range <sup>1</sup>		Dim. L	Tab Feature	Tab Size	Stock Thickness		Strip Part Number
	AWG	mm				Tab Section	Mag. Wire Section	
A 300 Box Standard IDC Narrow Body Latch Type	33-31	0.18-0.23	.630 16.00	Dimple	.187 x .020 4.75 x 0.51	.020 0.51	.010 0.25	63108-1†
	31-28	0.23-0.32	.630 16.00	Dimple	.187 x .020 4.75 x 0.51	.020 0.51	.010 0.25	62743-1†
	30-27	0.25-0.36	.630 16.00	Dimple	.187 x .020 4.75 x 0.51	.020 0.51	.012 0.30	63109-1†
	27-23	0.36-0.57	.630 16.00	Dimple	.187 x .020 4.75 x 0.51	.020 0.51	.016 0.41	63107-1
				Dimple	.187 x .020 4.75 x 0.51	.020 0.51	.016 0.41	1217493-1
	23-20 <sup>2</sup>	0.57-0.81	.630 16.00	Dimple	.187 x .020 4.75 x 0.51	.020 0.51	.016 0.41	63340-1
	22-20 <sup>2</sup>	0.64-0.81	.630 16.00	Dimple	.187 x .020 4.75 x 0.51	.020 0.51	.016 0.41	63429-1
	19-17 <sup>2</sup>	0.91-1.15	.630 16.00	Dimple	.187 x .020 4.75 x 0.51	.020 0.51	.016 0.41	62888-1
				Hole	.187 x .020 4.75 x 0.51	.020 0.51	.016 0.41	63782-1
	18 lead <sup>2</sup>	0.80-0.92 mm <sup>2</sup>	.630 16.00	—	.187 x .020 4.75 x 0.51	.020 0.51	.016 0.41	1217592-1†
B <sup>3</sup> Narrow Body Latch Type w/ Strain Relief Slot	23.5-20 <sup>2</sup>	0.54-0.81	.630 16.00	Dimple	.187 x .020 4.75 x 0.51	.020 0.51	.016 0.41	1217004-1

1 Two magnet wires may be terminated in the same terminal slot if diameters are equal.  
 2 Single magnet wire only; 22 AWG [0.64 mm] or larger.  
 3 Strain relief slot for high vibration applications.  
 † These part numbers are available upon special request; contact TE Engineering for details.

Chart continued on next page

**Standard MAG-MATE Terminals (Continued)**
**187 Series  
FASTON Tab Terminals**

(Continued)

**Material**

Tin plated brass

**Typical Cavity Size**

(See page 23)

Type A—Cavity Size 4

Type B—Cavity Size 4

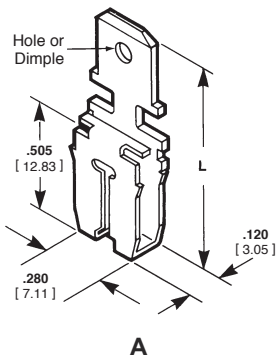
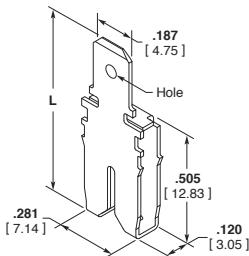
**A**

**B**

Type	Copper Magnet Wire Range <sup>1</sup>		Dim. L	Tab Feature	Tab Size	Stock Thickness		Strip Part Number	
	AWG	mm				Tab Section	Mag. Wire Section		
A <sup>3</sup> 500 Box Standard IDC	22-20	0.64-0.81	.830 21.08	Hole	.187 x .020 4.75 x 0.51	.020 0.51	.020 0.51	1742819-1	
	19-17	0.91-1.15	.830 21.08	Hole	.187 x .020 4.75 x 0.51	.020 0.51	.020 0.51	1742820-1	
	17.5-16	1.09-1.29	.830 21.08	Hole	.187 x .020 4.75 x 0.51	.020 0.51	.020 0.51	63667-1	
				Hole	.187 x .032 4.75 x 0.81	.032 0.81	.020 0.51	63427-1	
	16-15	1.29-1.45	.830 21.08	Hole	.187 x .020 4.75 x 0.51	.020 0.51	.020 0.51	63762-1	
				Dimple	.187 x .020 4.75 x 0.51	.020 0.51	.020 0.51	63353-1	
	14.5-13 <sup>2</sup>	1.54-1.83	.830 21.08	Hole	.187 x .020 4.75 x 0.51	.020 0.51	.020 0.51	1217902-1	
	B <sup>3,4</sup> 500 Box Single IDC w/ Strain Relief Slot	27-23	0.36-0.57	.830 21.08	Hole	.187 x .020 4.75 x 0.51	.020 0.51	.020 0.51	1217042-1
		22-20	0.64-0.81	.830 21.08	Hole	.187 x .020 4.75 x 0.51	.020 0.51	.020 0.51	63983-1
					Hole	.187 x .032 4.75 x 0.81	.032 0.81	.020 0.51	1217339-1
19-17		0.91-1.15	.830 21.08	Hole	.187 x .020 4.75 x 0.51	.020 0.51	.020 0.51	63995-1	
				Hole	.187 x .032 4.75 x 0.81	.032 0.81	.020 0.51	1217090-1	
16-15	1.29-1.45	.830 21.08	Hole	.187 x .020 4.75 x 0.51	.020 0.51	.020 0.51	63996-1		

1 Two magnet wires may be terminated in the same terminal slot if diameters are equal.

2 Single magnet wire only.

3 After insertion into plastic cavity, tab portion must be bent over 45°-90° or potted in to prevent pullout when mating receptacle is disconnected.

4 Strain relief slot for high vibration applications.

Standard MAG-MATE Terminals (Continued)

250 Series  
FASTON Tab Terminals

Material

Tin plated brass

Typical Cavity Size

(See page 23)

Type A—Cavity Size 2

Type B—Cavity Size 5

Type C—Cavity Size 3

Note: .250 [6.35] tab terminals mate with compatible FASTON receptacles. Request Catalog 82004.



Type	Copper Magnet Wire Range <sup>1</sup>		Dim. L	Tab Feature	Tab Size	Stock Thickness		Strip Part Number
	AWG	mm				Tab Section	Mag. Wire Section	
A <sup>3</sup> 300 Box Standard IDC .250 [6.35] FASTON Tab	33-31	0.18-0.23	.750 19.05	Dimple	.250 x .032 6.35 x 0.81	.032 0.81	.010 0.25	62600-1*
	30-27	0.25-0.36	.750 19.05	Dimple	.250 x .032 6.35 x 0.81	.032 0.81	.012 0.30	62651-1*
	28-24	0.32-0.51	.750 19.05	Hole	.250 x .032 6.35 x 0.81	.032 0.81	.016 0.41	63607-1
	27-23	0.36-0.57	.750 19.05	Dimple	.250 x .032 6.35 x 0.81	.032 0.81	.016 0.41	62652-1*
	22-20	0.64-0.81	.750 19.05	Dimple	.250 x .032 6.35 x 0.81	.032 0.81	.016 0.41	1217924-1
B Narrow Body Latch Type	19-17	0.91-1.15	.750 19.05	Dimple	.250 x .032 6.35 x 0.81	.032 0.81	.020 0.51	1742398-1
	33-31	0.18-0.23 <sup>1</sup>	.750 19.05	Dimple	.250 x .032 6.35 x 0.81	.032 0.81	.010 0.25	63026-1
	30-27	0.25-0.36 <sup>1</sup>	.750 19.05	Dimple	.250 x .032 6.35 x 0.81	.032 0.81	.012 0.30	63027-1
	27-23	0.36-0.57	.750 19.05	Dimple	.250 x .032 6.35 x 0.81	.032 0.81	.016 0.41	1217860-1
	23-20 <sup>2</sup>	0.57-0.81	.750 19.05	Dimple	.250 x .032 6.35 x 0.81	.032 0.81	.016 0.41	1217870-1
C Wide Body Latch Type	33-31	0.18-0.23	.750 19.05	Hole	.250 x .032 6.35 x 0.81	.032 0.81	.010 0.25	63309-1
	31-28	0.23-0.32	.750 19.05	Dimple	.250 x .032 6.35 x 0.81	.032 0.81	.012 0.30	63403-2
	30-28	0.25-0.32	.750 19.05	Hole	.250 x .032 6.35 x 0.81	.032 0.81	.012 0.30	1217152-1
	30-27	0.25-0.36	.750 19.05	Dimple Hole	.250 x .032 6.35 x 0.81	.032 0.81	.012 0.30	63132-1 63499-1
	27-23	0.36-0.57	.750 19.05	Hole Dimple	.250 x .032 6.35 x 0.81	.032 0.81	.016 0.41	63571-1 63128-1
	22-20 <sup>2</sup>	0.64-0.81	.750 19.05	Dimple	.250 x .032 6.35 x 0.81	.032 0.81	.016 0.41	63601-2
	19-17 <sup>2</sup>	0.91-1.15	.750 19.05	Hole	.250 x .032 6.35 x 0.81	.032 0.81	.016 0.41	63614-1

1 Two magnet wires may be terminated in the same terminal slot if diameters are equal.  
 2 Single magnet wire only; 22 AWG [0.64 mm] or larger.  
 3 After insertion into plastic holder, tab portion must be bent over 45°-90° or potted in to prevent pullout when mating receptacle is disconnected.

\* Recognized under the Component Program of Underwriters Laboratories, Inc.

Standard MAG-MATE Terminals

Chart continued on next page

**Standard MAG-MATE Terminals (Continued)**

**250 Series  
FASTON Tab Terminals**

(Continued)

**Material**

Tin plated brass

**Typical Cavity Size**

(See page 23)

Type A—Cavity Size 4

Type B—Cavity Size 4

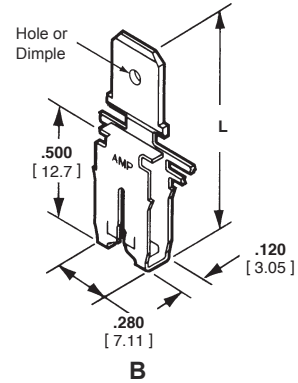
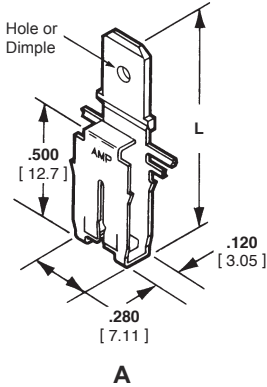

Type	Copper Magnet Wire Range <sup>1</sup>		Dim. L	Tab Feature	Tab Size	Stock Thickness		Strip Part Number
	AWG	mm				Tab Section	Mag. Wire Section	
A <sup>3</sup> 500 Box Standard IDC Wide Neck	22-20	0.64-0.81	.952 24.18	Hole	.250 x .032 6.35 x 0.81	.032 0.81	.020 0.51	63495-1
	19-17	0.91-1.15	.952 24.18	Hole	.250 x .032 6.35 x 0.81	.032 0.81	.020 0.51	63464-3
	16-15	1.29-1.45	.952 24.18	Hole	.250 x .032 6.35 x 0.81	.032 0.81	.020 0.51	63459-2
	14-13 <sup>2</sup>	1.61-1.83	.952 24.18	Dimple	.250 x .032 6.35 x 0.81	.032 0.81	.020 0.51	63460-1
				Hole	.250 x .032 6.35 x 0.81	.032 0.81	.020 0.51	63816-1
B <sup>3</sup> 500 Box Standard IDC Narrow Neck	22-20	0.64-0.81	.952 24.18	Dimple	.250 x .032 6.35 x 0.81	.032 0.81	.020 0.51	63155-1
	19-17	0.91-1.15	.952 24.18	Dimple	.250 x .032 6.35 x 0.81	.032 0.81	.020 0.51	62923-1
	16-15	1.29-1.45	.952 24.18	Dimple	.250 x .032 6.35 x 0.81	.032 0.81	.020 0.51	63064-1
	14-13 <sup>2</sup>	1.61-1.83	.952 24.18	Dimple	.250 x .032 6.35 x 0.81	.032 0.81	.020 0.51	63465-1
	12 <sup>2</sup>	2.05	.952 24.18	Dimple	.250 x .032 6.35 x 0.81	.032 0.81	.020 0.51	63425-1

<sup>1</sup> Two magnet wires may be terminated in the same terminal slot if diameters are equal.

<sup>2</sup> Single magnet wire only.

<sup>3</sup> After insertion into plastic holder, tab portion must be bent over 45°-90° or potted in to prevent pullout when mating receptacle is disconnected.



**Standard MAG-MATE Terminals (Continued)**

Standard MAG-MATE Terminals

**Typical Plastic Cavity**

Illustrations shown are for reference only. They are not a purchased item. Manufacture only according to TE Specification.

**Technical Documents**

**Application Specifications** describe requirements for using the product in its intended application and or crimping information. They are intended for the Packaging and Design Engineer and the Machine Setup Person.

- 114-2050 —Poke-In Tab MAG-MATE Terminals
- 114-2069 —Standard MAG-MATE .187 [4.75] Box Height Terminals
- 114-2046 —Standard MAG-MATE .300 [7.62] Box Height Terminals
- 114-2066 —Standard MAG-MATE .500 [12.7] Box Height Terminals
- 114-2067 —Standard MAG-MATE .300 [7.62] Box Height Latch-In Terminals Narrow Body
- 114-2094 —Standard MAG-MATE .300 [7.62] Box Height Latch-In Terminals Wide Body



Cavity Size 1  
 .187 [4.75] Box  
 MAG-MATE  
 (Application Spec. 114-2069)

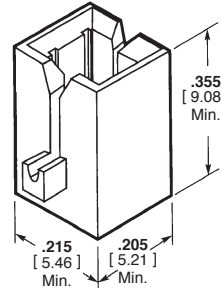

Cavity Size 2  
 .300 [7.62] Box  
 MAG-MATE  
 (Application Spec. 114-2046)



Cavity Size 3  
 .300 [7.62] Box  
 Latch-In MAG-MATE Wide Body  
 (Application Spec. 114-2094)



Cavity Size 4  
 .500 [12.70] Box  
 MAG-MATE  
 (Application Spec. 114-2066)

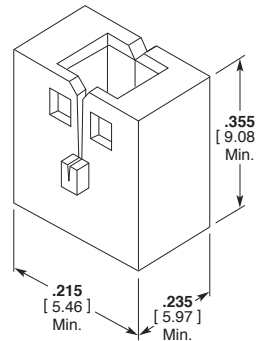

Cavity Size 5  
 .300 [7.62] Box  
 Latch-In MAG-MATE,  
 Narrow Body  
 (Application Spec. 114-2067)

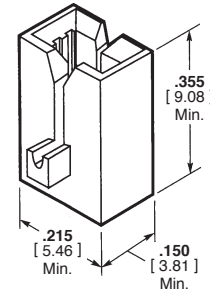

Cavity Size 6  
 .300 [7.62] Box  
 MAG-MATE  
 (Application Spec. 114-2046)

**Note:** The MAG-MATE typical plastic cavities shown above are for reference only. They are not a purchased item. Refer to appropriate TE application specification for details.

Plastic cavities, designed to TE specifications, may be molded as part of the coil bobbin or attached to a lamination stack in the area of the magnet wire coil. Each cavity is a rectangular box with two narrow slots on opposing walls and a plastic post or anvil extending upward from the bottom surface. During or after the winding process, the magnet wire is placed across the plastic cavities and into the slots, either manually or by coil winding equipment.

Unraveling is prevented by a slight friction fit, suitable bend or by wrapping the magnet wire around a tie-off post.

During insertion, two insulation displacing terminal slots strip the film insulation from the magnet wire producing a stable electrical termination.

The plastic anvil supports the magnet wire, helping to prevent it from being dragged down when the terminal is inserted.

Terminal retention is secured in the plastic cavities by either locking barbs or locking latches in addition to locking barbs for quick disconnect FASTON tab terminals.

Excess magnet wire is trimmed flush with the outside of the plastic cavity by a shear blade traveling with the terminal insertion ram.

The sheared wire end can be tucked inside the plastic cavity, if necessary, by cutting the wire off before the terminal is fully seated allowing the terminal to drag the severed end of the wire into the pocket inside the cavity.

**TE will provide design and mold engineering resources to manufacture any specifically designed MAG-MATE cavity housing.**

**Standard MAG-MATE Terminals (Continued)**

**Typical Plastic Cavities**

Illustrations shown are for reference only. They are not a purchased item. Manufacture only according to TE Specification.



Slim Line MAG - MATE  
Reference Application  
Spec. 114-2147



Mini MAG - MATE  
Reference Application  
Spec. 114-2047

**Technical Documents  
Application Specifications**

describe requirements for using the product in its intended application and or crimping information. They are intended for the Packaging and Design Engineer and the Machine Setup Person.

114-2140—Slim Line  
MAG-MATE  
Terminals

**Technical Documents  
Application Specifications**

describe requirements for using the product in its intended application and or crimping information. They are intended for the Packaging and Design Engineer and the Machine Setup Person.

114-2047—Mini MAG-MATE  
Terminals

### Slim Line MAG-MATE Terminals

**Product Facts**

- Terminates all magnet wire film insulations
- Eliminates need for pre-stripping conductors
- Eliminates need to post-insulate terminations
- Excess magnet wire is automatically trimmed during the termination process
- 187 and 250 Series Faston Tab and posted PCB Tab terminals available
- Terminates 33-17 AWG [0.18-1.15 mm ] magnet wire
- Simultaneously terminates two magnet wires of the same size in one terminal from 33-23 AWG [0.18-0.57 mm ]
- Available in strip form for semi-automatic or fully automatic insertions
- High speed, fully automated integrated systems provide uniform terminations reliably at the lowest possible applied cost
- Clean metal-to-metal interface produces stable, gas-tight electrical terminations free of oxides and other contaminants
- Recognized under the Component Recognition Program of Underwriters Laboratories Inc., File No. E13288 

**Applications**

- Motor windings and connections
- Coil Connections
- Transformer windings and connections
- Bobbin connections
- Lighting Ballasts
- Power Supplies



TE offers a full selection of 187 and 250 Series Faston and posted PCB Slim Line MAG-MATE Tab insulation displacement (IDC) terminals for magnet wire terminations.

Slim Line MAG-MATE terminals with a single IDC slot terminate 33-17 AWG [0.18 to 1.15 mm].

Each IDC slot terminates a range of up to four consecutive magnet wire sizes.

Two magnet wires with the same diameter can be terminated in one terminal. Except as noted.

MAG-MATE cavities are either integrated into coil bodies or especially designed cavity housings. The magnet wires are precisely positioned in the plastic cavity slots.

The MAG-MATE Inserter cuts the terminals from the strip and places the terminals over the magnet wire into the plastic cavities.

During this operation, small stripping shoulders in the IDC slot remove the film insulation from the magnet wire.

Wiping action between the wire and terminals removes oxides or other contaminants present on both the conductor and the terminal slot side walls, producing a clean, stable, gas-tight electrical termination.

Residual spring energy in the terminal causes the side walls of each IDC slot to function as opposing cantilever beams.

This constant pressure results in an intimate metal-to-metal interface, providing a reliable, long-term connection.

The MAG-MATE Inserter may be used as a semi-automatic bench machine or integrated in production lines for fully-automatic applications.

Slim Line MAG-MATE Terminals

**Slim Line MAG-MATE Terminals (Continued)**
**187 Series  
FASTON Tab Terminals**
**Material**

Tin plated brass



Type	Copper Magnet Wire Range <sup>1</sup>		Dim. L	Tab Feature	Tab Size	Stock Thickness		Strip Part Number
	AWG	mm				Tab Section	Mag.Wire Section	
A .187 [4.75] FASTON Tab	33-31	0.18-0.23	.630 16.00	Hole	.187 x .020	.020	.012	63710-2
				Dimple	4.75 x 0.51	.051	0.30	63738-2
	30-28	0.25-0.32	.630 16.00	Hole	.187 x .032	.032	.012	63711-2
				Dimple	4.75 x 0.51	.051	0.30	63737-2
	27-24	0.36-0.51	.630 16.00	Hole	.187 x .020	.020	.016	63712-2
				Dimple	4.75 x 0.51	.051	0.41	63736-2
	23-20 <sup>2</sup>	0.57-0.81	.760 19.31	Plain	.187 x .020	.020	.016	1217497-1
				Hole	4.75 x 0.51	.051	0.41	
	19-17 <sup>2</sup>	0.91-1.15	.630 16.00	Hole	.187 x .020	.020	.016	63713-2
				Dimple	4.75 x 0.51	.051	0.41	63735-2
	19-17 <sup>2</sup>	0.91-1.15	.630 16.00	Hole	.187 x .032	.032	.016	1217516-1
				Dimple	4.75 x 0.51	.051	0.41	63714-2
	19-17 <sup>2</sup>	0.91-1.15	.630 16.00	Hole	.187 x .020	.020	.016	63714-2
				Dimple	4.75 x 0.51	.051	0.41	63734-2

1 Two magnet wires may be terminated in the same terminal slot if diameters are equal.  
2 Single magnet wire only; 22 AWG [0.64] or larger.

**250 Series  
FASTON Tab Terminals**
**Material**

Tin plated brass

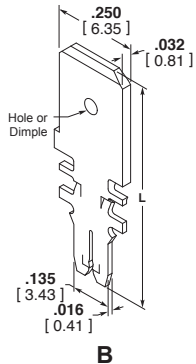

Type	Copper Magnet Wire Range <sup>1</sup>		Dim. L	Tab Feature	Tab Size	Stock Thickness		Strip Part Number
	AWG	mm				Tab Section	Mag.Wire Section	
B .250 [6.35] FASTON Tab	33-31	0.18-0.23	.752 19.10	Hole	.250 x .032	.032	.012	63716-2
				Dimple	6.35 x 0.81	0.81	0.30	63744-2
	30-28	0.25-0.32	.752 19.10	Hole	.250 x .032	.032	.012	63717-2
				Dimple	6.35 x 0.81	0.81	0.30	63743-2
	27-24	0.36-0.51	.752 19.10	Hole	.250 x .032	.032	.016	63718-2
				Dimple	6.35 x 0.81	0.81	0.41	63742-2
	23-20 <sup>2</sup>	0.57-0.81	.752 19.10	Hole	.250 x .032	.032	.016	63719-2
				Dimple	6.35 x 0.81	0.81	0.41	63741-2
	19-17 <sup>2</sup>	0.91-1.15	.752 19.10	Hole	.250 x .032	.032	.016	63720-2
				Dimple	6.35 x 0.81	0.81	0.41	63740-2

1 Two magnet wires may be terminated in the same terminal slot if diameters are equal.  
2 Single magnet wire only; 22 AWG [0.64] or larger.

**Posted PCB  
SOLDER Terminal**
**Material**

Tin plated brass

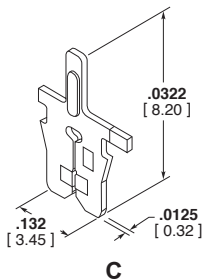

Type	Copper Magnet Wire Range <sup>1</sup>		Dim. L	Tab Feature	Tab Size	Stock Thickness		Strip Part Number
	AWG	mm				Tab Section	Mag.Wire Section	
C .040 [1.00] PCB Tab	33.5-30	0.17-0.25	.323 8.20	Embossment	.040 x .024	.024	.013	1534684-1
					1.00 x 0.60	0.60	0.32	
	29.5-26	0.27-0.40	.323 8.20	Embossment	.040 x .024	.024	.013	1534685-1
					1.00 x 0.60	0.60	0.32	
	26-22	0.40-0.63	.323 8.20	Embossment	.040 x .024	.024	.013	1534686-1
					1.00 x 0.60	0.60	0.32	
	22-20	0.63-0.81	.323 8.20	Embossment	.040 x .024	.024	.013	1740829-1
					1.00 x 0.60	0.60	0.32	
	21.5-19.5	0.67-0.85	.323 8.20	Embossment	.040 x .024	.024	.013	1534687-1
					1.00 x 0.60	0.60	0.32	

1 Two magnet wires may be terminated in the same terminal slot if diameters are equal.  
2 Single magnet wire only; 22 AWG [0.64] or larger.

**Slim Line MAG-MATE Terminals** (Continued)

**Offset Tab Terminals**

**Material**

Tin Plated Brass

Applications where I/O Tab spacing must be less than IDC connection spacing

Example: automotive accessory coils



**A**

Type	Copper Magnet Wire Range <sup>1</sup>		Dim. L	Diode Size	Tab Size	Stock Thickness		Strip Part Number
	AWG	mm				Tab Section	Mag.Wire Section	
A Combination Diode Slot/Tab	33-31	0.18-0.23	.725 18.42	#20 0.8	.059 x .032 1.50 x 0.81	0.032 0.81	0.012 0.30	63888-1
	33-31	0.18-0.23	.725 18.42	#22.5 0.6	.059 x .032 1.50 x 0.81	0.032 0.81	0.012 0.30	63903-1

<sup>1</sup> Two magnet wires may be terminated in the same terminal slot if diameters are equal.

**Posted PCB Terminals**

**Multi-Spring Solderless Terminal**

**Material**

Tin Plated Copper Alloy

**Cavity Size**

Application Spec.

Contact TE Engineering



**B**

Type	Copper Magnet Wire Range <sup>1</sup>		Dim. L	Stock Thickness		Strip Part Number
	AWG	mm		Tab Section	Mag.Wire Section	
B Multi-Spring Solderless PCB Tab Terminal	33-29.5	0.18-0.265	.583 14.80	.031 0.81	.013 0.32	2120743-2
	29.5-26	0.265-0.40	.583 14.80	.031 0.81	.013 0.32	2120744-2
	26-22.5	0.40-0.63	.583 14.80	.031 0.81	.013 0.32	2120745-2
	22.5-19.5 <sup>2</sup>	0.63-0.85	.583 14.80	.031 0.81	.013 0.32	2120746-2
	19.5-17 <sup>2</sup>	0.85-1.12	.583 14.80	.031 0.81	.013 0.32	2120747-2

<sup>1</sup> Two magnet wires may be terminated in the same terminal slot if diameters are equal.

<sup>2</sup> Single magnet wire only. 22 awg [0.63 mm] and larger.

**Note:** PC Board hole size .057 [1.45]

**Slim Line MAG-MATE Terminals** (Continued)

**Posted PCB  
Solder Terminals**

**Material**

Unplated brass



A

Type	Copper Magnet Wire Range		Stock Thickness	Strip Part Number
	AWG	mm		
A MAG-MATE Terminal with MQS Pins	33-30	0.256-0.40	Varied thickness	1-1987222-1
	33 <sup>1</sup>	0.40-0.56 <sup>1</sup>		
	30-26	0.256-0.40	Varied thickness	1-1987223-1
	30-26 <sup>1</sup>	0.40-0.56 <sup>1</sup>		
	26-22	0.40-0.63	Varied thickness	1-1987224-1
	26-23 <sup>1</sup>	0.40-0.56 <sup>1</sup>		
	22-20	0.63-0.80	Varied thickness	1-1987225-1
	20-17	0.85-1.12	Varied thickness	1-1987226-1

<sup>1</sup> For double magnet wires



### Mini MAG-MATE Terminals

#### Product Facts

- Terminates all fine gauge magnet wire film insulations
- Eliminates need to pre-strip conductors
- Eliminates need to post insulate terminations
- Terminates 52-30 AWG [0.02-0.25 mm] diameter copper magnet wire
- Poke-In leaf style accepts 22 -18 AWG [0.3-0.9 mm] overcoated stranded or solid lead wire
- Available in strip form for semi-automatic or fully automatic insertions
- High speed, fully automated integrated systems provide uniform terminations and reliability at the lowest possible applied cost
- Recognized under the Component Recognition Program of Underwriters Laboratories Inc, File No. E13288



#### Applications

- Ignition coils
- Small motors
- Synchronist timers
- Electric meter coils
- Solenoids
- Relays



TE offers Mini MAG-MATE poke-in, crimp wire barrel, post and quick disconnect tab insulation displacement (IDC) terminals for fine gauge magnet wire terminations.

Mini MAG-MATE terminals are designed to terminate 52-30 AWG [0.02-0.25 mm] diameter copper magnet wire.

Poke-in leaf terminals accept 22-18 AWG [0.3-0.9 mm<sup>2</sup>] overcoated stranded or solid lead wire.

The terminal design uses the AMPLIVAR serrated burr technology to penetrate the film insulation of copper magnet wire.

Mini MAG-MATE cavity pockets, designed to TE specifications, include a wire

receiving slot and wire tie-off post that is either integrated into coil bodies or specially designed cavity housings.

The magnet wire is wrapped around the tie-off post and placed across the cavity slot. After the coil is wound, the finish end of the magnet wire is dressed through the second cavity slot and tied to its tie-off post.

The Mini MAG-MATE Inserter shears the terminal from the carrier strip and inserts the terminal into the cavity by a dual ram insertion mechanism.

As the unexpanded terminal approaches the bottom of the cavity, the upper ram stops. The lower ram continues to push to a prescribed depth to expand the terminal and complete

the termination process.

The fully seated terminal fits squarely into the cavity, while the serrated leg of the terminal cams against the pre-positioned magnet wire to penetrate the film insulation and provide a stable electrical termination.



**Mini MAG-MATE Terminals (Continued)**



**Poke-In Terminal**

**Material**

.010 [0.25] tin plated brass

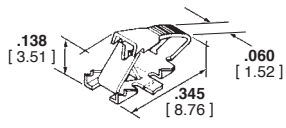

**A**

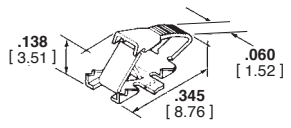

**B**



**C**

Type	Copper Magnet Wire Range		Lead Wire Range <sup>1</sup>		Mating Tab	Stock Thickness		Strip Part Number
	AWG	mm	AWG	mm <sup>2</sup>		Poke-In Beam	Mag Wire	
A Lead Wire Poke-In	52-42	0.02-0.06	22-18	0.3-0.9	—	0.010 0.25	0.010 0.25	62781-1
	44-36	0.05-0.13	22-18	0.3-0.9	—	0.010 0.25	0.010 0.25	62780-1
	38-30	0.10-0.25	22-18	0.3-0.9	—	0.010 0.25	0.010 0.25	62606-1
B Tab Poke-In	52-42	0.02-0.06	—	—	.060 x .020 1.52 x 0.51	0.010 0.25	0.010 0.25	63613-1
	44-36	0.05-0.13	—	—	.060 x .020 1.52 x 0.51	0.010 0.25	0.010 0.25	63795-1 <sup>2</sup>
	38-30	0.10-0.25	—	—	.060 x .020 1.52 x 0.51	0.010 0.25	0.010 0.25	63844-2 <sup>2</sup>
C Skinny Mini	40-34.5	0.08-0.15	—	—	.040 x .020 1.00 x 0.51	0.010 0.25	0.010 0.25	1718165-1

<sup>1</sup> Solid or overcoated stranded lead wire only.  
<sup>2</sup> Radius on beam leaf tip.

**Mini MAG-MATE Terminals** (Continued)

**Posted Terminal**

**Material**

Tin over premilled brass

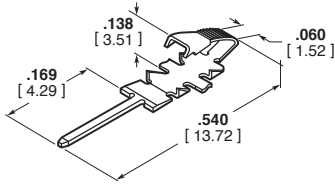

A

Type	Copper Magnet Wire Range		Post Size	Stock Thickness		Strip Part Number
	AWG	mm		Post	Mag Wire	
A PCB Post	38-30	0.10-0.25	.024 x .020 0.62 x 0.51	0.020 0.51	0.010 0.25	63675-4

**FASTON Tab Terminals**

**Material**

Tin over premilled brass

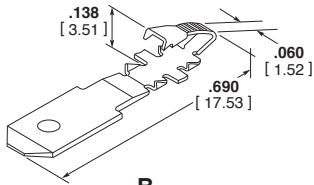

B

Type	Copper Magnet Wire Range				Tab Size	Stock Thickness		Strip Part Number
	G	W	A	m		Post	Mag Wire	
B .187 [4.75] FASTON Tab	44-36		0.05-0.13		.187 x .020 4.75 x 0.51	.020 0.51	.010 0.25	63778-1
	38-30		0.10-0.25		.187 x .020 4.75 x 0.51	.020 0.51	.010 0.25	1217529-1

**Crimp Wire Barrel Terminal**

**Material**

Tin plated brass

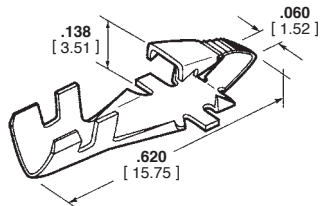

C

Type	Copper Magnet Wire Range		Lead Wire Range		Stock Thickness		Strip Part Number
	AWG	mm	AWG	mm <sup>2</sup>	Crimp Barrel	Mag Wire	
C Crimp Wire Barrel	38-30	0.10-0.25	22-18	0.3-0.9	0.010 0.25	0.010 0.25	63199-1 <sup>1</sup>

<sup>1</sup> Wire and insulation barrel reversed so lead wire exits over magnet wire termination area.

## SIAMEZE Terminals

### Product Facts

- Terminates all copper magnet wire film insulations
- Eliminates need for pre-stripping conductors
- Moving Beam contact design connects a wide range of magnet wire sizes with a single terminal
- Standard range terminals connect 34-18 AWG [0.16-1.0 mm] magnet wire
- Fine range terminals connect 36-27 AWG [0.13-0.38 mm] magnet wire
- Medium range terminals connect 23-12 AWG [0.56-2.03 mm] magnet wire
- Excess magnet wire is automatically trimmed during the termination process
- Available in strip form for semi-automatic or fully automatic insertions
- Loose piece terminals available for manual tool insertions
- High-speed automatic coil winding machine terminations provide uniform reliability at the lowest possible applied cost
- Clean metal-to-metal interface produces stable, gas-tight electrical terminations free of oxides and other contaminants
- Recognized under the Component Program of Underwriters Laboratories Inc., File No. E13288



### Applications

- Motor windings and connections
- Coil connections
- Transformer windings and connections
- Ballasts
- Power supplies
- Solenoids
- Actuators

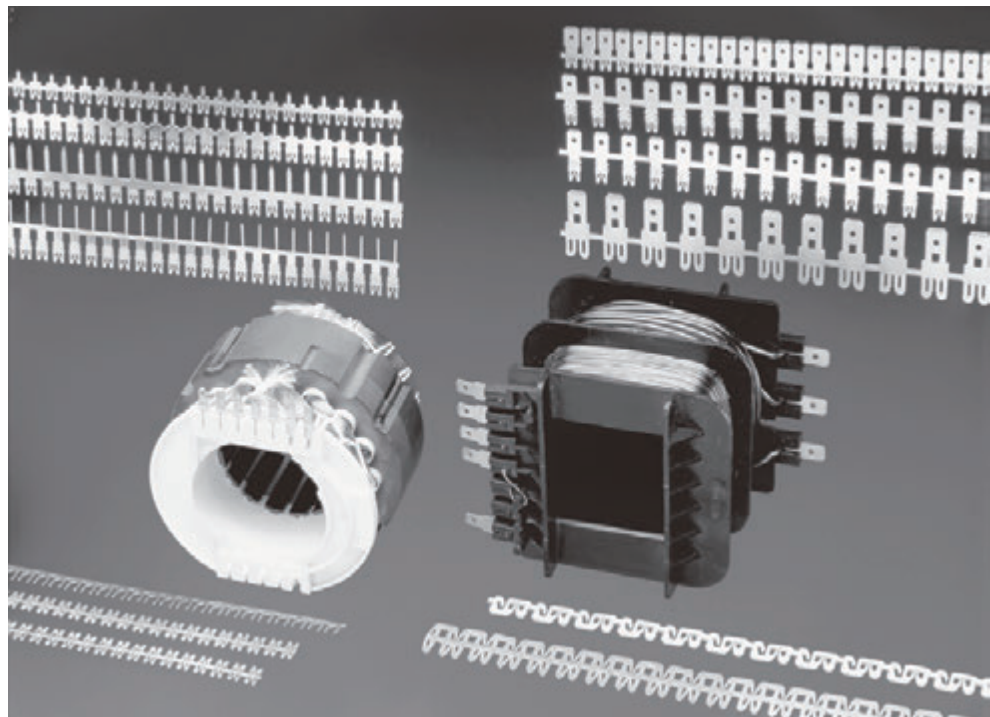

TE offers a full selection of SIAMEZE insulation displacement (IDC) terminals for interconnecting copper magnet wires, lead wires, and other components.

The SIAMEZE insulation displacement (IDC) terminal technology eliminates the need to strip the film insulation from copper magnet wires and lead wires.

Terminals are available in wire-to-wire, Lead Lok, quick disconnect tabs, posts, pin and receptacle terminals.



Available with either Moving Beam contacts whereby a single terminal connects to a very wide range of magnet wire sizes, or a Compliant Beam for contacting two magnet wires of the same diameter in one terminal for splicing or bi-filar applications.

Tab terminals are available with single barbs or multiple retention barbs for higher retention.

According to TE specifications SIAMEZE cavities are either integrated into coil bodies or specially designed cavity housings.

The magnet wires are positioned in the "U" shaped slots.

The SIAMEZE terminal Inserter cuts the terminals from the strip and places the terminals over the magnet wire into the plastic cavities.

During this operation the small stripping devices penetrate the film insulation from the magnet wire.

Residual spring energy in the terminal causes the side walls of the IDC slot to function as opposing cantilever beams.

This constant pressure results in an intimate metal-to-metal interface, providing a reliable, long-term connection.

The wiping action between the wire and terminals remove all oxides or other contaminants present on both the conductor and the terminal slot side walls, producing a clean, stable, gas-tight electrical termination.

The SIAMEZE terminal Inserter may be used as a semi-automatic bench machine or integrated in production lines for fully-automatic applications.

**SIAMEZE Terminals** (Continued)

**Lead Lok Terminals**

**Product Facts**

- Provides perpendicular and parallel lead wire strain relief retention forces in excess of 20 lbs (90 N).
- Inserter automatically positions and secures lead wire during insertion
- Manual, semi-automated, fully automated systems allow for lead wire termination
- Accepts #18 - #22 [0.3mm 2-0.8 mm<sup>2</sup>] AWG solid or stranded lead wire with .115 [2.92 ] max.insulation diameter
- No lead wire stripping required



SIAMEZE Terminals

TE features the Lead Lok strain relief terminal system that provides optimum lead wire retention when used in conjunction with SIAMEZE insulation displacement terminals. After the one-step insertion of SIAMEZE wire-to-wire terminals into TE specified plastic cavities, the application is ready for the secondary lead wire attachment. The lead wire is manually positioned over the magnet wire terminated SIAMEZE wire-to-wire terminal. The Lead Lok Inserter

cuts the Lead Lok terminals from the strip and places the terminal over the lead wire in the plastic cavities. During this operation, the lead wire is automatically seated, the insulation pierced and the exposed conductor is terminated in the IDC slot of the SIAMEZE wire-to-wire terminal. Residual spring energy in the terminal causes the side walls of the IDC slot to function as opposing cantilever beams. This constant pressure results in an intimate

metal-to-metal interface, providing a reliable, long-term connection. Perpendicular and parallel lead wire strain relief retention forces in excess of 20 lbs are achieved. The Lead Lok Inserter may be a secondary station in the SIAMEZE Wire-to-Wire semi-automatic bench machine. Information regarding terminal insertion equipment may be found in Magnet Wire Termination Overview #138516.

**TECHNICAL DOCUMENTS**

Cavity Specifications - Provide dimensional design guidelines & criteria for a cavity to be used with a SIAMEZE IDC terminal. The appropriate Cavity Specification number is shown on the following pages adjacent to the terminal number. As a general reference, overall dimensions are shown at the end of this section.

- **Product Specifications** ( These describe the performance characteristics and verification tests )
  - 108-2085 Standard Range SIAMEZE Insulation Displacement
  - 108-2293 High Temperature Standard Range SIAMEZE Insulation Displacement
  - 108-2244 Fine Range SIAMEZE Insulation Displacement
  - 108-2239 Medium Range SIAMEZE Insulation Displacement
  - 108-2316 Heavy Range SIAMEZE Insulation Displacement
- **Application Specifications** ( These describe the requirements for using the product in its intended application )
  - 114-13166 Standard and Fine Range SIAMEZE Insulation Displacement
  - 114-13210 Medium and Heavy Range SIAMEZE Insulation Displacement

Dimensions are in inches and millimeters unless otherwise specified. Values in brackets are metric equivalents.

Dimensions are shown for reference purposes only. Specifications subject to change.

**SIAMEZE Terminals** (Continued)

**SIAMEZE Interconnection System**

**How the System Operates**

① **Magnet Wire**

The magnet wire is positioned in “U” slot manually or automatically by coil winding equipment.

② **Terminal Insertion Finger**

The terminal insertion finger is part of the SIAMEZE Inserter. It pushes the terminal that was sheared from the carrier strip through the “tube” into the cavity.

③ **Contact**

Various wire attachments in standard, fine, medium and heavy duty terminals are available (See tables).

④ **IDC Slot**

The IDC slot in the terminal will terminate a wide range of magnet wire sizes.

⑤ **Stripping Burrs**

During the insertion process, these burrs strip the film insulation from the magnet wire.

⑥ **Retention Barbs**

Terminal retention is provided in the cavity by single or multiple locking barbs.

**Test Results**

SIAMEZE products have been submitted to the following tests without significant millivolt increase:

⑦ **Plastic Cavity**

Design must comply with TE connectivity specifications (for cavity drawing numbers see tables). **Consulting TE is required for design in.**

⑧ **Cavity Slot for Wire**

The width has to be in accordance with the wire size (see cavity drawings).

⑨ **Wire Cutoff Block**

The wire cutoff block supports the magnet wire during the trimming process. The magnet wire is cut plain to the cavity front side.

⑩ **Trim Blade**

The trim blade cuts the excess magnet wire and the wire cutoff block at the front of the cavity.

⑪ **Terminal Insertion Complete**

The magnet wire termination is complete when the terminal is fully seated in the cavity.

**Current Cycling—**

250 cycles with each cycle consisting of 15 minutes “ON” followed by 15 minutes “OFF”

**Thermal Shock—**

25 Cycles -40°C to +125°C,  
25 Cycles -40°C to +175°C  
for High Temperature terminals

**Humidity—**

**Temperature Cycling**

10 cycles between 25°C and 65°C at 80 to 100% RH

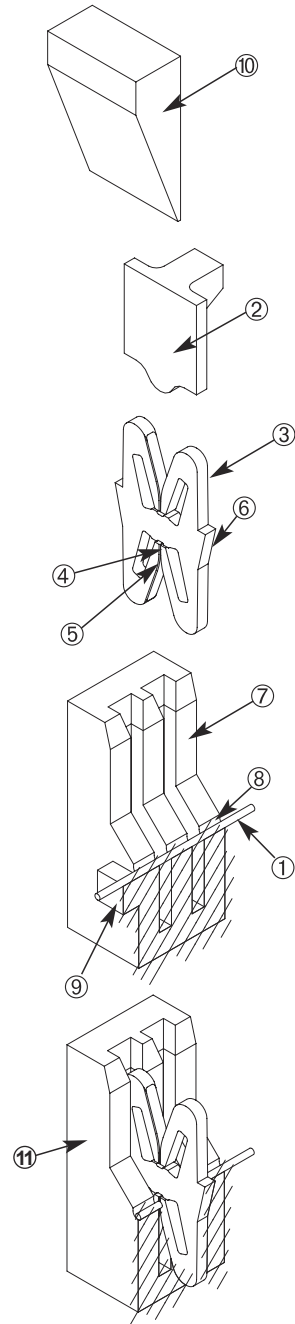



**SIAMEZE Terminals** (Continued)

**Lead Lok Interconnection System**

**How the System Operates**

- ① **Lead Lok Insertion Finger**  
The Lead Lok insertion finger pushes the Lead Lok that was sheared from the carrier strip and positions the Lead Lok and lead wire into the IDC slot.
- ② **Lead Lok Terminal**  
The Lead Lok terminal provides maximum lead wire retention in the cavity.
- ③ **Retention Barbs**  
The Lead Lok multiple barbs provide retention in the cavity.
- ④ **Lead Wire**  
Stranded, solid and bonded lead wire with 105°C PVC insulation can be used. Contact TE Engineering for other lead wires and insulation under consideration.
- ⑤ **IDC Slot**  
The IDC slot will pierce the lead wire during insertion.
- ⑥ **Lead Wire Insertion Complete**  
The lead wire termination is complete when the Lead Lok is fully seated in the cavity.

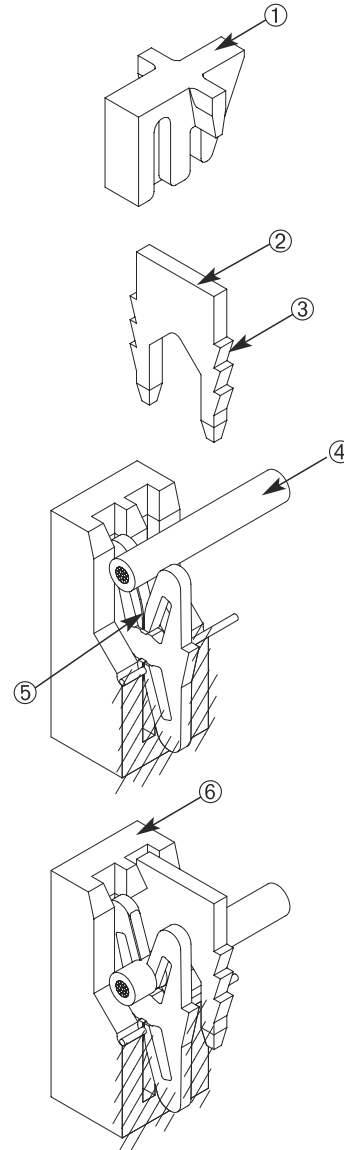

**HOW TO CONNECT MULTIPLE MAGNET WIRES OR OTHER COMPONENTS**

- ① **Bussed High Carrier Terminals**  
Bridging of two SIAMEZE terminals that is accomplished by leaving the carrier strip between two adjacent terminals intact.
- ② **Bussed High Carry SIAMEZE Plastic Cavity**  
Bussed cavity pocket designs are available for double or triple bussed terminals.
- ③ **Magnet Wire**  
Magnet wire may be equal or differ in size for bi-filar applications.

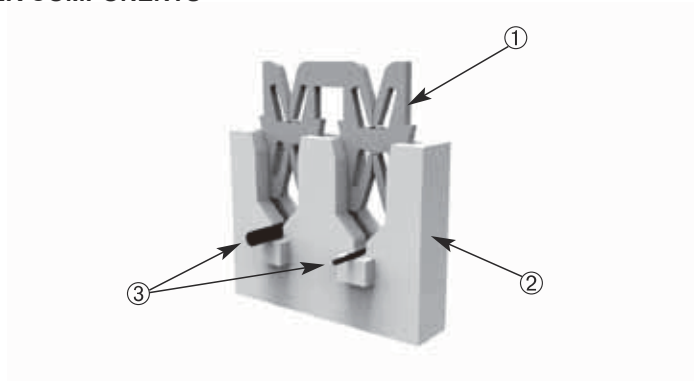

**SIAMEZE Terminals**

**SIAMEZE Terminals (Continued)**

**Wire-to-Wire Terminals**

**Material**  
Brass



Type	Recommended Pocket <sup>7</sup>	Copper Magnet Wire Range		Lead Wire Range		Part Number	
		AWG	mm	AWG	mm <sup>2</sup>	Reeled	Loose
A Moving Beam	1601421	18-34	1.02-0.16	18-22 <sup>6</sup>	0.8-0.3	1601000-1 1601000-2 <sup>5</sup>	4-1601000-1 <sup>2</sup> 4-1601000-2 <sup>2,5</sup>
		27-36	0.36-0.13	18-22 <sup>6</sup>	0.8-0.3	1601117-1 2-1601117-1 <sup>1</sup>	4-1601117-1 <sup>2</sup>
B Wire Specific <sup>8</sup>	1601421	18-34	1.02-0.16	20	0.5	1601056-1 2-1601056-1 <sup>1</sup>	4-1601056-1 <sup>2</sup>
		18-34	1.02-0.16	18	0.8	1601074-1 2-1601074-1 <sup>1</sup>	4-1601074-1 <sup>2</sup>
C High Carrier	1601433 1601440	18-34	1.02-0.16	18-22 <sup>6</sup>	0.8-0.3	1601046-1 2-1601046-1 <sup>1</sup>	4-1601046-1 <sup>2</sup> 6-1601046-1 <sup>3</sup> 8-1601046-1 <sup>4</sup>
		27-36	0.36-0.13	20	0.5	1601237-1 2-1601237-1 <sup>1</sup>	4-1601237-1 <sup>2</sup> 6-1601237-1 <sup>3</sup>
E Medium Range	1601436	12-23	2.06-0.56	16-20	1.3-0.5	1601136-1 2-1601136-1 <sup>1</sup>	4-1601136-1 <sup>2</sup> 6-1601136-1 <sup>3</sup>
F Lead Lok	1601421			18-22	0.8-0.3	1601140-1 2-1601140-1 <sup>1</sup>	4-1601140-1
	1601433						
	1601440						

1 Reversed Reeled—Consult TE drawing for orientation.  
 2 Loose Single.  
 3 Loose Bussed (Bridged) Double.  
 4 Loose Bussed (Bridged) Triple.  
 5 Finish is Post Plated Tin over Copper (Consult TE drawing for specifics).  
 6 Lead wire may be stranded, solid or bonded with 105°C PVC insulation. Contact TE Engineering when using other types of insulation.  
 7 Magnet wire 30 AWG [0.25 mm] and smaller also requires a wrap post per drawing 1601447.  
 8 Wire Specific terminals have a top contact designed to penetrate difficult Lead Wire Insulation (e.g Irradiated types).



**SIAMEZE Terminals** (Continued)

**Receptacle Terminals**  
**(Wire to Blade)**

**Material**

Brass



**A**

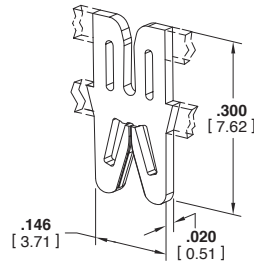

**B**



**C**

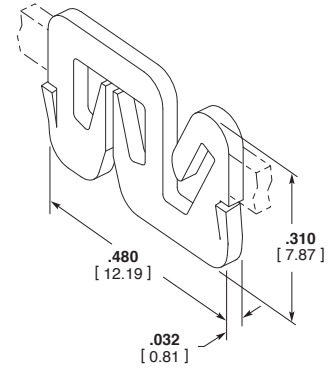

**D**

Type	Recommended Pocket <sup>5</sup>	Copper Magnet Wire Range		L <sup>8</sup> Dim.	Mating Tab Size	Part Number	
		AWG	mm			Reeled	Loose
A Wire2Blade In Line	1601425	18-34	1.02-0.16	.300 7.62	.020 0.51	1601075-1	4-1601075-1 <sup>2</sup>
						2-1601075-1 <sup>1</sup>	
						1601075-2 <sup>6</sup>	4-1601075-2 <sup>6</sup>
						2-1601075-2 <sup>1,6</sup>	
						2-1601075-3 <sup>1,7</sup>	-
B Wire2Blade High Carrier In Line	1601426	18-34	1.02-0.16	.300 7.62	.020 0.51	1601196-1	4-1601196-1 <sup>2</sup>
						2-1601196-1 <sup>1</sup>	6-1601196-1 <sup>3</sup> 8-1601196-1 <sup>4</sup>
C Wire2Blade In Line Medium Range	1601436	15-23	1.47-0.56	.550 13.97	.032 0.81	1601232-2 <sup>7</sup>	4-1601232-2 <sup>7</sup>
D Wire2Blade Off Line Medium Range	1601437	15-23	1.47-0.56	.310 7.87	.032 0.81	1601137-2 <sup>6</sup>	4-1601137-2 <sup>6</sup>

1 Reverse Reeled –Consult TE drawing for orientation.  
 2 Loose Bussed (Bridged) Double.  
 3 Loose Bussed (Bridged) Triple.  
 4 Loose Bussed (Bridged) Triple.  
 5 Magnet wire 30 AWG [0.25] and smaller also requires a wrap post per Specification 1601447.  
 6 Finish is Pre Plated Tin (Consult TE drawing for specifics).  
 7 Finish is Post Plated Tin over Nickel (Consult TE drawing for specifics).  
 8 Overall Height of terminal does not include inserted Blade (Tab).

**Pin Terminals**

**Material**

Brass



**E**

Type	Recommended Pocket <sup>2</sup>	Copper Magnet Wire Range		L Dim.	Pin Dia.	Part Number	
		AWG	mm			Reeled	Loose
E Round Pin	1601424	18-34	1.02-0.16	.718 18.24	.084 2.13	1601077-1	4-1601077-1 <sup>3</sup>
						2-1601077-1 <sup>1</sup>	

1 Reverse Reeled –Consult TE drawing for orientation.  
 2 Magnet wire 30 AWG [0.25 mm] and smaller also requires a wrap post per drawing 1601447.  
 3 Loose piece single.

**SIAMEZE Terminals (Continued)**

**Post Terminals**

**Material**

Brass

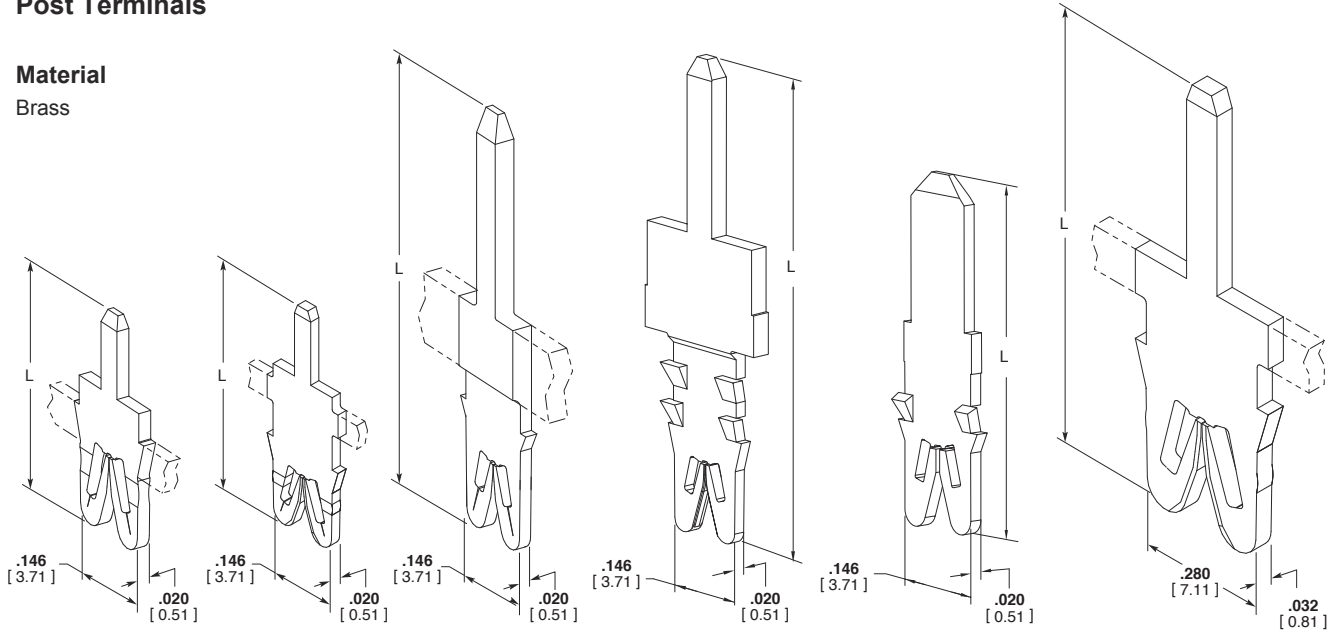

Type	Recommended Pocket <sup>7</sup>	Copper Magnet Wire Range		Tab Size	L Dim.	Part Number	
		AWG	mm			Reeled	Loose
A PC Tab	1601424	18-34	1.02-0.16	.040 x .020	.345	1601009-4 <sup>5</sup>	4-1601009-4 <sup>2.5</sup>
				1.02 x 0.51	8.76	2-1601009-4 <sup>1.5</sup>	
		29**	0.29	.040 x .020	.405	1601214-2 <sup>5</sup>	4-1601214-2 <sup>2.5</sup>
				1.02 x 0.51	10.29	2-1601214-2 <sup>1.5</sup>	
27-36	0.36-0.13	.040 x .020	.345	1601155-3 <sup>5</sup>	4-1601155-3 <sup>2.5</sup>		
		1.02 x 0.51	8.76	2-1601155-3 <sup>1.5</sup>			
B Extended PC Tab	1601425	18-34	1.02-0.16	.040 x .020	.456	1601095-2 <sup>4</sup>	4-1601095-2 <sup>2.4</sup>
				1.02 x 0.51	11.57	2-1601095-2 <sup>2.4</sup>	
		27-36	0.36-0.13	.040 x .020	.485	1601041-3 <sup>5</sup>	4-1601041-3 <sup>2.5</sup>
				1.02 x 0.51	12.32	2-1601041-3 <sup>1.5</sup>	
C Long Narrow Blade	1601431	18-34	1.02-0.16	.040 x .020	.485	1601128-3 <sup>5</sup>	4-1601128-3 <sup>2.5</sup>
				1.02 x 0.51	12.32	2-1601128-3 <sup>1.5</sup>	
				.047 x .032	.754	1601110-2 <sup>6</sup>	4-1601110-2 <sup>2.5</sup>
				1.20 x 0.81	19.16	2-1601110-2 <sup>1.6</sup>	
				.059 x .032	.669	1601099-2 <sup>5</sup>	4-1601099-2 <sup>2.5</sup>
				1.50 x 0.81	17.00	2-1601099-2 <sup>1.5</sup>	
				.059 x .032	.756	1601063-2 <sup>6</sup>	4-1601063-2 <sup>2.6</sup>
				1.50 x 0.81	19.21	2-1601063-2 <sup>1.6</sup>	
D Long Narrow Blade Mult-Barb	1601425	18-34	1.02-0.16	.059 x .032	.904	1601037-2 <sup>6</sup>	4-1601037-2 <sup>2.6</sup>
				1.50 x 0.81	22.96	2-1601037-2 <sup>1.6</sup>	
				.059 x .032	1.005	1601066-2 <sup>6</sup>	4-1601066-2 <sup>2.6</sup>
				1.50 x 0.81	25.53	2-1601066-2 <sup>1.6</sup>	
E Medium Width Blade Mult-Barb	1601475	18-34	1.02-0.16	.071 x .025	.974	1601104-2 <sup>6</sup>	4-1601104-2 <sup>2.6</sup>
				1.80 x 0.64	24.74	2-1601104-2 <sup>1.6</sup>	
		27-36	0.36-0.13	.118 x .020	.533	1601243-2 <sup>3</sup>	4-1601243-2 <sup>2.3</sup>
				3.00 x 0.51	13.54	2-1601243-2 <sup>1.3</sup>	
F Medium Width Blade Medium wire range	1601438	12-23	0.56-2.06	.118 x .025	.952	1601119-2 <sup>6</sup>	4-1601119-2 <sup>2.6</sup>
				3.00 x 0.64	24.18	2-1601119-2 <sup>1.6</sup>	
F Medium Width Blade	1601438	12-23	0.56-2.06	.130 x .032	.872	1601138-1	4-1601138-1 <sup>2</sup>
				3.30 x 0.81	22.15	2-1601138-1 <sup>1</sup>	

1 Reverse Reeled –Consult TE drawing for orientation.  
 3 Finish is Post Plated Tin (Consult TE drawing for specifics).  
 5 Finish is Post Plated Tin over Nickel (Consult TE drawing for specifics).  
 7 Magnet wire 30 AWG [0.25] and smaller also requires a wrap post per Specification 1601447

2 Loose Piece Single.  
 4 Finish is Post Plated Tin over Copper (Consult TE drawing for specifics).  
 6 Finish is Pre Plated Tin (Consult TE drawing for specifics)  
 \*\* Compliant contact can connect 2 wires of the same diameter.

**SIAMEZE Terminals (Continued)**
**110 Series (2.8 mm wide)  
FASTON Tab Terminals**
**Material**

Brass

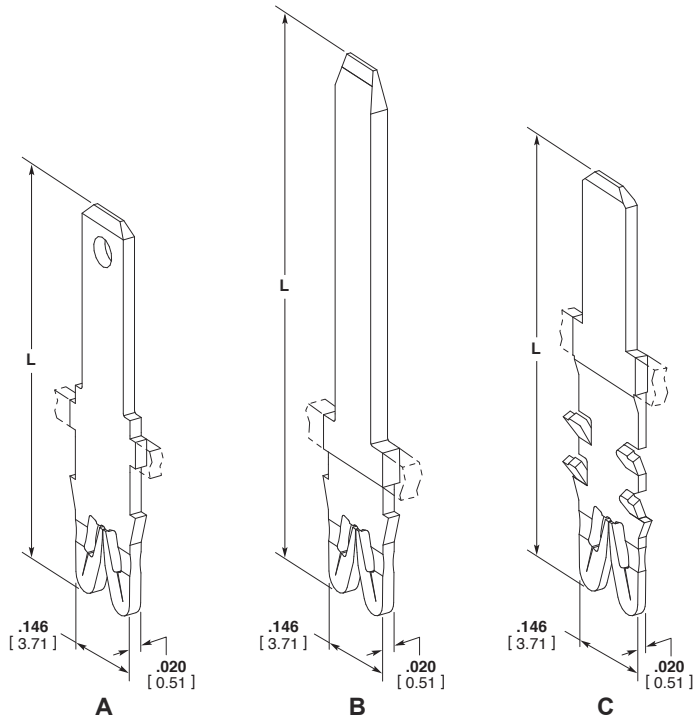

Type	Recommended Pocket <sup>8</sup>	Copper Magnet Wire Range		Thickness	L Dim.	Part Number	
		AWG	mm			Reeled	Loose
A Single Barb	1601425	18-34	1.02-0.16	.020	.640	1601005-1	4-1601005-1 <sup>2</sup>
				0.51	16.26	2-1601005-1 <sup>1</sup>	
				.020	.640	1601204-2 <sup>6,7</sup>	4-1601204-2 <sup>2,6,7</sup>
				0.51	16.26	2-1601204-2 <sup>1,6,7</sup>	
				.020	.846	1601045-1	4-1601045-1 <sup>2</sup>
				0.51	21.49	2-1601045-1 <sup>1</sup>	
B Single Barb Low Transition	1601431	18-34	1.02-0.16	.020	.846	1601059-1 <sup>7</sup>	4-1601059-1 <sup>2,7</sup>
				0.51	21.49	2-1601059-1 <sup>1,7</sup>	
				.020	.925	1601073-1	4-1601073-1 <sup>2</sup>
				0.51	23.50	2-1601073-1 <sup>1</sup>	
				.032	.945	1601097-3 <sup>6,7</sup>	4-1601097-3 <sup>2,6,7</sup>
				0.81	24.00	2-1601097-3 <sup>1,6,7</sup>	
C Multi-Barb	1601425	18-34	1.02-0.16	.020	.655	1601039-1	4-1601039-1 <sup>2</sup>
				0.51	16.63	2-1601039-1 <sup>1</sup>	
				.020	.655	1601039-2 <sup>6</sup>	4-1601039-2 <sup>2,6</sup>
				0.51	16.63	2-1601039-2 <sup>1,6</sup>	
				.032	.630	1601064-1 <sup>7</sup>	4-1601064-1 <sup>2,7</sup>
				0.81	15.99	2-1601064-1 <sup>1,7</sup>	
				.032	1.240	1601112-2 <sup>6,7</sup>	4-1601112-2 <sup>2,6,7</sup>
				0.81	31.50	2-1601112-2 <sup>1,6,7</sup>	
				.032	1.240	1601133-2 <sup>6,7</sup>	4-1601133-2 <sup>2,6,7</sup>
				0.81	31.50	2-1601133-2 <sup>1,6,7</sup>	
	27-36	0.36-0.13	.032	1.240	1601133-2 <sup>6,7</sup>	4-1601133-2 <sup>2,6,7</sup>	
			0.81	31.50	2-1601133-2 <sup>1,6,7</sup>		

1 Reverse Reeled-Consult TE drawing for orientation.

2 Loose Piece Single.

3 Finish is Post Plated Tin over Nickel (Consult TE drawing for specifics).

4 Finish is Post Plated Tin (Consult TE drawing for specifics).

5 Finish is Pre-Plated Tin over Copper (Consult TE drawing for specifics).

6 Finish is Pre-Plated Tin (Consult TE drawing for specifics).

7 No hole in Tab.

8 Magnet wire 30 AWG [0.25] and smaller also requires a wrap post per Specification 1601447.

**SIAMEZE Terminals (Continued)**

**187 Series (4.75 mm wide)  
FASTON Tab Terminals**

**Material**

Brass  
(except High Temp listed below)



Type	Recommended Pocket <sup>3</sup>	Copper Magnet Wire Range		Thickness	L Dim.	Part Number	
		AWG	mm			Reeled	Loose
A Single Barb	1601425	18-34	1.02-0.16	.020	.605	1601006-2 <sup>5</sup>	4-1601006-2 <sup>2,5</sup>
				0.51	15.37	2-1601006-2 <sup>1,5</sup>	
B Single Barb Short Pocket	1601427	18-34	1.02-0.16	.020	.505	1601011-1	4-1601011-1 <sup>2</sup>
				0.51	12.83	2-1601011-1 <sup>1</sup>	
				.020	.590	1601018-2 <sup>5,6</sup>	4-1601018-2 <sup>2,5,6</sup>
				0.51	14.99	2-1601018-2 <sup>1,5,6</sup>	
				.020	.985	1601033-2 <sup>5,6</sup>	4-1601033-2 <sup>2,5,6</sup>
				0.51	25.02	2-1601033-2 <sup>1,5,6</sup>	
				.020	.618	1601021-2 <sup>5,6</sup>	4-1601021-2 <sup>2,5,6</sup>
				0.51	15.70	2-1601021-2 <sup>1,5,6</sup>	
				.020	.655	1601013-1	4-1601013-1 <sup>2</sup>
				0.51	16.64	2-1601013-1 <sup>1</sup>	
C Multi-Barb	1601425	18-34	1.02-0.16	.020	.791	3-1601072-2 <sup>5,6</sup>	4-1601072-2 <sup>2,5,6</sup>
				0.51	20.09		
				.020	0.832	1601068-2 <sup>5,6</sup>	4-1601068-2 <sup>2,5,6</sup>
				0.51	21.14	2-1601068-2 <sup>1,5,6</sup>	
				.032	.625	1601174-2 <sup>5,6</sup>	4-1601174-2 <sup>2,5,6</sup>
				0.81	15.88	2-1601174-2 <sup>1,5,6</sup>	
				.032	.655	1601035-1	4-1601035-1 <sup>2</sup>
				0.81	16.64	2-1601035-1 <sup>1</sup>	
				.032	.655	1601035-2 <sup>5</sup>	4-1601035-2 <sup>2,5</sup>
				0.81	16.64	2-1601035-2 <sup>1,5</sup>	
		20-23**	0.58-0.81	.032	.745	293029-1 <sup>5</sup>	-
				0.81	18.92	2-293029-1 <sup>1,5</sup>	
D Multi-Barb Short Profile	1601434	18-34	1.02-0.16	.020	.655	1601142-1	4-1601142-1 <sup>2</sup>
				0.51	16.64	2-1601142-1 <sup>1</sup>	
				.032	0.492	1601058-2 <sup>5,7</sup>	4-1601058-2 <sup>2,5,7</sup>
				0.81	12.50	2-1601058-2 <sup>1,5,7</sup>	
				.032	0.571	1601226-1 <sup>3,6</sup>	4-1601226-1 <sup>2,3,6</sup>
				0.81	14.50	2-1601226-1 <sup>1,3,6</sup>	
E Multi-Barb .187/.250 Profile	1601425	18-34	1.02-0.16	.020	.655	1601020-1	4-1601020-1 <sup>2</sup>
				0.51	16.64	2-1601020-1 <sup>1</sup>	
				.020	.655	1601020-2 <sup>5</sup>	4-1601020-2 <sup>2,5</sup>
				0.51	16.64	2-1601020-2 <sup>1,5</sup>	
		18-34	1.02-0.16	.020	.805	1601049-2 <sup>5</sup>	4-1601049-2 <sup>2,5</sup>
				0.51	20.45	2-1601049-2 <sup>1,5</sup>	

1 Reverse Reeled-Consult TE drawing for orientation.

3 High Temperature Copper Alloy.

5 Finish is Pre Plated Tin (Consult TE drawing for specifics).

6 No hole in Tab.

7 Extra Short Tab-Does not meet UL & NEMA length requirements.

\*\* Compliant contact can connect 2 wires of the same diameter

2 Loose Piece Single.

4 Finish is Post Plated Tin (Consult TE drawing for specifics).

8 Magnet wire 30 AWG [0.25] and smaller also requires a wrap post per Specification

1601447.

**SIAMEZE Terminals** (Continued)

**250 Series (6.3 mm wide)  
FASTON Tab Terminals**

**Material**

Brass



Type	Recommended Pocket <sup>6</sup>	Copper Magnet Wire Range		L Dim.	Tab Feature	Tab Size	Part Number				
		AWG	mm				Reeled	Loose			
A Multi-Barb	1601425	27-36	0.36-0.13	.745	Hole	.250 x .032 6.35 x 0.81	1601118-2 <sup>3</sup>	4-1601118-2 <sup>3</sup>			
				18.92			2-1601118-2 <sup>1,3</sup>				
		18-34	1.02-0.16	.745	Hole	.250 x .032 6.35 x 0.81	1601002-2 <sup>3</sup>	4-1601002-2 <sup>3</sup>			
				18.92			2-1601002-2 <sup>1,3</sup>				
				.805			20.45	Hole	.250 x .032 6.35 x 0.81	1601028-2 <sup>3</sup>	4-1601028-2 <sup>3</sup>
										2-1601028-2 <sup>1,3</sup>	
Dimple	.250 x .032 6.35 x 0.81	1601028-1	4-1601028-1								
		2-1601028-1 <sup>1</sup>									
Hole	.250 x .032 6.35 x 0.81	284937-1 <sup>7</sup>	—								
		2-284937-1 <sup>1,7</sup>									
B Single Barb Medium Range	1601438	12-23	2.03-0.56	.778	—	.250 x .032 6.35 x 0.81	1601061-2 <sup>3</sup>	4-1601061-2 <sup>3</sup>			
				19.76			2-1601061-2 <sup>1,3</sup>				
C Single Barb Heavy Range	1601435	12-20	2.03-0.8	.885	Hole	.250 x .032 6.35 x 0.81	1601115-1	4-1601115-1			
				22.48			2-1601115-1 <sup>1</sup>				
		16-17 <sup>5</sup>	1.27-1.15	.885	Hole	.250 x .032 6.35 x 0.81	1601159-1	4-1601159-1			
									22.48	2-1601159-1 <sup>1</sup>	
14-15 <sup>5</sup>	1.60-1.40	.885	Hole	.250 x .032 6.35 x 0.81	1601161-1	4-1601161-1					
							22.48	2-1601161-1 <sup>1</sup>			

1 Reverse Reeled –Consult TE drawing for orientation.  
 2 Finish is Pre-Plated Tin over Copper (Consult TE drawing for specifics).  
 3 Finish is Pre-Plated Tin (Consult TE drawing for specifics).  
 4 Double Carrier Strip.  
 5 Two magnet wires may be terminated in the same slot if diameters are equal.  
 6 Magnet wire 30 AWG [0.25 mm] and smaller also requires a wrap post per drawing 1601447.  
 7 Hole size and position complies with DIN standard.

SIAMEZE Terminals

**SIAMEZE Terminals** (Continued)

**Typical Plastic Cavity Pockets**

**Note:**The overall dimensions shown on these pages are for general reference only. For design purposes refer to the TE Cavity Specification.

Plastic cavities, designed to TE specifications, may be molded as part of the coil bobbin or attached to a lamination stack in the area of the magnet wire coil.

Each cavity is a rectangular box with two narrow slots on opposing walls and a plastic cutoff or tie-off post.

During or after the winding process, the magnet wire is placed across the plastic cavities and into the slots, either manually or by coil winding equipment.

Unraveling is prevented by a slight friction fit, suitable bend or by wrapping the magnet wire around the wrap post.

During insertion, the insulation displacing terminal slot strip the film insulation from the magnet wire producing a stable electrical termination.

Terminal retention is retained in the plastic cavities by single or multiple barbs (Refer to Product Spec for force requirements).

Excess magnet wire is trimmed flush with the outside of the plastic cavity by a shear blade traveling with the terminal insertion ram.

**TE can provide design and mold engineering resources to manufacture most specifically designed SIAMEZE cavity housings.**



Cavity Specification 1601421



Cavity Specification 1601424



Cavity Specification 1601425



Cavity Specification 1601426



Cavity Specification 1601427



Cavity Specification 1601431

\* Minimum dimension with Lead Lok slot.

**SIAMEZE Terminals (Continued)**

**Typical Plastic Cavity Pockets (Continued)**



**Cavity Specification 1601432**

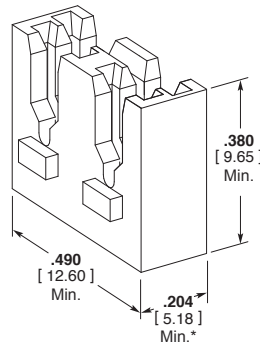

**Cavity Specification 1601433**



**Cavity Specification 1601434**



**Cavity Specification 1601435**



**Cavity Specification 1601436**



**Cavity Specification 1601437**



**Cavity Specification 1601438**



**Cavity Specification 1601440**



**Wrap Post Specification 1601447**



**Cavity Specification 1601475**

\* Minimum dimension with Lead Lok slot.

SIAMEZE Terminals



## AMPLIVAR Splices

### Product Facts

- **Compression crimp eliminates cold solder points, weld burns and wire embrittlement usually connected with thermal-type terminations**
- **Excellent tensile strength—vibration resistant**
- **Provides a superior electrical connection that is free of many contaminants such as stripper residue and solder flux**
- **Precision formed, strip-fed splices terminated in automatic machines for high production rates per hour**
- **High termination rates, low wire consumption and the elimination of rejects caused by solder flux or heat damage results in the lowest applied costs**
- **Precisely controlled crimp termination helps eliminate human error for maximum reliability**
- **Splice up to 3 magnet wires together with stranded lead in one barrel**

### Applications

- **Motor windings and connections**
- **Coil connections**
- **Transformer windings and connections**
- **Solid wire connections**
- **Lighting ballasts**
- **Power supplies**
- **Starters and alternators**



TE Connectivity offers a full selection of AMPLIVAR splices that are specifically designed to terminate magnet wire to itself or in combination with standard solid or stranded lead wire.

AMPLIVAR splices have machined, sharp edged serrations inside the crimp barrels. These serrations, made by a special production process, pierce the insulating layer of magnet wires in a manner that provides a large contact area.

In a one-step operation the magnet wire is automatically multiple ring-stripped of its

insulation as it is forced into the serrations during the precisely controlled crimp.

The resulting termination produces a high tensile strength, air-sealed connection that is as resistant to corrosion as the insulated conductor.

As many as three magnet wires can be terminated simultaneously in one splice. In addition, copper or aluminum magnet wire, or a combination of both, can be terminated.

When required, copper or aluminum magnet wire can

be combined with standard, pre-stripped solid or stranded lead wires.

Depending on your specific application, AMPLIVAR splices are available in 5, 7 and 9 serration versions for terminations in the 100 to 22,000 CMA range as well as miniature and subminiature designs for terminations in the 100 to 1850 CMA range.

The crimping of AMPLIVAR splices is done by semi-automatic crimping machines for high output per hour production rates.



Stranded Wire on top

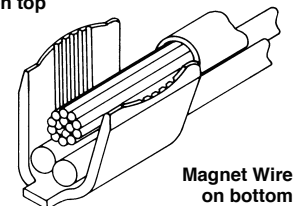

Magnet Wire on bottom

**AMPLIVAR Splices** (Continued)

**Technical Features**

**Applicable Types of Wire** — Cu, Al (Solid) together or in combination with stranded lead wire

**Wire Size Range** — from 300 to 13,000 CMA (0.1 mm<sup>2</sup> to 6.6 mm<sup>2</sup>)

**Terminal Base Material** — Brass, phosphor bronze

**Surface Finish** — plain and tin plated except where noted

**Temperature Range** — -65°C to +150°C

**Rated Current** — according connected wire size

**Rated Voltage** — according terminated winding

**Test Results**

The AMPLIVAR products have been subjected to the following tests without significant millivolt losses.

**Temperature Cycling** — 25 cycles with each cycle consisting of 30 minutes at +125°C followed by 30 minutes at -65°C

**Heat Age** — 96 hours at +150°C

**Thermal Shock** — 25 cycles with each cycle consisting of 30 minutes at +150°C followed by 30 minutes at -65°C

**Salt Spray** — 96 hours at +35°C with a 5% salt solution spray

**Humidity** — 96 hours at 90–95% relative humidity and +40°C

**Current Cycling** — 10,000 cycles with each consisting of 3 minutes on and 3 minutes off at a current (25 A) which establishes a wire temperature

**TYPICAL CURRENT CYCLING TEST RESULTS**

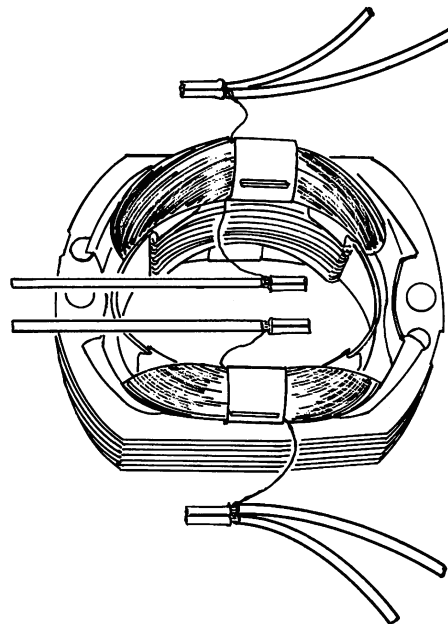

AMPLIVAR Splices

**AMPLIVAR Splices** (Continued)

**General Application Guidelines**

To assist you in obtaining the optimum AMPLIVAR product termination, the following guidelines are recommended:

1. All magnet wires must be placed in the bottom of the wire barrel before crimping. If lead wire is to be crimped in the same termination, it should be placed on top of the magnet wires.
2. Wire barrels are designed to accept a maximum of three insulated magnet wires plus stranded lead wires.
3. The ratio of magnet wire diameters crimped in any wire barrel should not exceed 2:1. This ratio is approximately a range from the largest to the smallest magnet wire of six sizes.
4. The sum of the circular mil area (CMA) of the magnet wires and any lead wires should not exceed the capacity of the splice.
5. The sum of the diameters of the individual magnet wires plus twice the terminal stock thickness must be equal to or less than the crimp width.
6. Magnet wire of 26 AWG [0.40 mm] or smaller should be used with 7-serration splices having "shallow serrations," and magnet wire of 28 AWG [0.32 mm] or smaller should be used with 9-serration splices having "shallow serrations" (part numbers identified with asterisk [\*] are in the tabular data on the following technical pages).
7. Magnet wire of 20 AWG [0.81 mm] or larger having an insulation thickness heavier than "single film coated," should not be used with splices having "shallow serrations" (those part numbers marked with an asterisk [\*] in the tabular data on the following technical pages).
8. When aluminum magnet wire is used, splices and terminals must be tin plated.
9. Consult TE for splice and terminal selection and recommendations for all non-standard applications.

**Technical Documents**

**Application specifications** describe requirements for using the product in its intended application and or crimping information. They are intended for the packaging and design engineer and the machine setup person.

114-2002	AMPLIVAR 7-serration pigtail splices	114-2006	AMPLIVAR subminiature pigtail splices
114-2003	AMPLIVAR 9-serration pigtail splices	114-2009	AMPLIVAR 5-serration thru splices
114-2005	AMPLIVAR subminiature thru splices	114-2016	AMPLIVAR miniature pigtail splices

**Suggested Splice Selection Procedure**

Use the following guide to help you to determine the proper splice for your application:

1. Use 9-serration splices, tin plated when terminating aluminum magnet wire or combinations with aluminum magnet wire.
2. Use 9-serration splices for hermetic and severe environment applications.
3. Use splices identified with an asterisk [\*] when terminating 7-serration 26 AWG [0.40 mm] or smaller wires and 9-serration 28 AWG [0.32 mm] or smaller wires.
4. Calculate the total CMA of the magnet wires plus any lead wires to be terminated. Always use the coated magnet wire for CMA (see pages 90-91).
5. Calculate the total magnet wire diameters (see pages 90 and 91).
6. Select a splice for trial calculations. It should have the proper CMA range. Plating finish should be considered at this time.
7. Calculate the sum of the magnet wire diameters plus two splice stock thicknesses. If this total is less than the crimp width of the splice selected, it may be used. If the total is greater than the crimp width, a splice with a greater crimp width must be selected. Consult TE for special wide tooling recommendations.

**Example:**

- Selection of a pigtail splice to terminate the following wires:  
 One 28 AWG [0.32 mm] copper magnet wire.  
 One 22 AWG [0.64 mm] aluminum magnet wire.  
 One 18 AWG [0.8-0.9 mm<sup>2</sup>] 19-strand copper lead wire.

■ Calculate the total CMA (Procedure 4):

28 AWG [0.32 mm] coated magnet wire	=	185 CMA
22 AWG [0.64 mm] coated magnet wire	=	708 CMA
18 AWG [0.8-0.9 mm <sup>2</sup> ] stranded lead wire	=	1608 CMA
<b>Total</b>		<b>= 2501 CMA</b>

■ Calculate the sum of the magnet wire diameters (Procedure 5):

28 AWG [0.32 mm] coated magnet wire	=	.0136 [0.35]
22 AWG [0.64 mm] coated magnet wire	=	.0266 [0.68]
<b>Total</b>		<b>= .0402 [1.03]</b>

■ Select a terminal for trial calculations. Splice No. 62305-2, page 47 (Procedure 6):

CMA range	=	600-3000
Stock thickness	=	.016 [0.41]
Crimp width	=	.110 [2.79]

9-serration, tin plated for aluminum magnet wire (Procedure 1).  
 Splice identified with asterisk [\*] for 28 AWG [0.32 mm] (Procedure 3).

■ Calculate the sum of the magnet wire diameters plus two splice stock thicknesses (Procedure 7):

.0402 + (.016 x 2) = .0722  
 [1.02 + (0.41 x 2) = 1.84  
 .0722 [1.84] is less than the splice crimp width of .110 [2.79]; therefore, Part No. 62305-2 may be used.

**AMPLIVAR Splices** (Continued)

**9 Serrations — Pigtail Type**

**Product Facts**

(Plus All 7 Serration Facts)

- Splice length is increased on larger CMA splices for improved performance
- Serration depths are varied within the splice to give optimum electrical/mechanical performance on all wire sizes
- Serration sidewall angles are varied to allow better wire stripping and serration fill
- Flat bottom of splice helps keep magnet wires on bottom as required during crimping
- Magnet wires 28 AWG [0.32 mm] and larger may be terminated without requiring shallow serrations
- Additional serrations enhance stability of crimp



AWG/ mm <sup>2</sup>	Wire Range Solid Dia.	Wire Range CMA	Stock Thickness	Crimp Width	Dim. L	Material	Part Number
24-18.5 0.26-0.80	.020-.039 0.55-1.00	400-1500	.016 0.41	.080 2.03	.225 5.72	Tin Plated Brass	62303-2*
22-15.5 0.38-1.54	.028-.055 0.70-1.40	600-3000	.020 0.51	.110 2.79	.225 5.72	Tin Plated Brass	62304-2
22-15.5 0.38-1.54	.028-.055 0.70-1.40	600-3000	.016 0.41	.110 2.79	.225 5.72	Tin Plated Brass	62305-2*
18.5-13.5 0.80-2.54	.039-.071 1.00-1.80	1500-5000	.020 0.51	.110 2.79	.225 5.72	Tin Plated Brass	62306-2
18.5-13.5 0.80-2.54	.039-.071 1.00-1.80	1500-5000	.016 0.41	.110 2.79	.225 5.72	Tin Plated Brass	62307-2*
15.5-12 1.54-3.46	.055-.083 1.40-2.10	3000-7000	.020 0.51	.140 3.56	.265 6.73	Tin Plated Brass	62308-2
13.5-10 2.54-4.90	.071-.098 1.80-2.50	5000-10,000	.025 0.64	.180 4.57	.265 6.73	Tin Plated Brass	62309-2
12-9 3.46-6.38	.083-.112 2.10-2.85	7000-14,000	.025 0.64	.180 4.57	.265 6.73	Tin Plated Brass	62310-2
10-8 4.90-8.60	.098-.130 2.50-3.31	10,000-17,000	.030 0.76	.250 6.35	.340 8.64	Tin Plated Brass	62311-2
9-6.5 7.07-9.45	.118-.137 3.00-3.47	14,000-22,000	.030 0.76	.250 6.35	.340 8.64	Tin Plated Brass	1742898-1

\*These splices are recommended for applications using wire size 28 AWG [0.32 mm] or smaller.  
 † Special high force application equipment required.



**7 Serrations — Pigtail Type**

**Product Facts**

- Taper on both crimper and anvil improves flex life of termination
- Longer “flat” on tooling improves electrical performance (.125 vs. .080 [3.18 vs. 2.03])
- Radius on wire entry end of splice helps prevent nicking wires and improves mechanical performance
- Serrations are offset to sheared end to place additional serrations in “electrical” portion of crimped splice
- Splice CMA ranges are overlapped so that two splices are available for any given CMA

AWG/ mm <sup>2</sup>	Wire Range Solid Dia.	Wire Range CMA	Stock Thickness	Crimp Width	Dim. L	Material	Part Number
22-15.5 0.38-1.54	.028-.055 0.70-1.40	600-3000	.020 0.51	.110 2.79	.225 5.72	Brass	62000-1
22-15.5 0.38-1.54	.028-.055 0.70-1.40	600-3000	.020 0.51	.110 2.79	.225 5.72	Brass	62157-1*
22-15.5 0.38-1.54	.028-.055 0.70-1.40	600-3000	.020 0.51	.110 2.79	.225 5.72	Tin Plated Brass	62000-2
22-15.5 0.38-1.54	.028-.055 0.70-1.40	600-3000	.020 0.51	.110 2.79	.225 5.72	Tin Plated Brass	62157-2*
22-15.5 0.38-1.54	.028-.055 0.70-1.40	600-3000	.020 0.51	.110 2.79	.225 5.72	Tin Plated Brass	62200-2 <sup>1</sup>
18.5-13.5 0.80-2.54	.039-.071 1.00-1.80	1500-5000	.020 0.51	.110 2.79	.225 5.72	Brass	62040-2
18.5-13.5 0.80-2.54	.039-.071 1.00-1.80	1500-5000	.020 0.51	.110 2.79	.225 5.72	Tin Plated Brass	62040-1
18.5-13.5 0.80-2.54	.039-.071 1.00-1.80	1500-5000	.020 0.51	.110 2.79	.225 5.72	Phosphor Bronze	964156-1
15.5-12 1.54-3.46	.055-.083 1.40-2.10	3000-7000	.020 0.51	.140 3.56	.225 5.72	Brass	62001-1
15.5-12 1.54-3.46	.055-.083 1.40-2.10	3000-7000	.020 0.51	.140 3.56	.225 5.72	Tin Plated Brass	62001-2
15.5-12 1.54-3.46	.055-.083 1.40-2.10	3000-7000	.020 0.51	.140 3.56	.225 5.72	Tin Plated Brass	62201-2 <sup>1</sup>
12-10 2.10-6.0	.085-.110 2.10-2.85	7000-12,000	.025 0.64	.250 6.35	.225 5.72	Tin Plated Brass	62295-1
12-10 2.10-6.0	.085-.110 2.10-2.85	7000-12,000	.025 0.64	.250 6.35	.225 5.72	Brass	62295-2
12-9 2.10-6.38	.085-.115 2.10-3.47	7000-13,000	.025 0.64	.180 4.57	.225 5.72	Tin Plated Brass	62002-2

\*These splices are recommended for applications using wire size 26 AWG [0.40 mm] or smaller.  
 † Flat bottom.



**AMPLIVAR Splices** (Continued)

**7 Serrations — Thru Type**

**Product Facts**

- Crimp bellmouth provides retention in circular cavity slot in bobbin

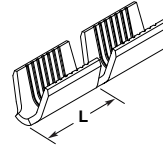

AWG/ mm <sup>2</sup>	Wire Range Solid Dia.	Wire Range CMA	Stock Thickness	Crimp Width	Dim. L	Material	Part Number
22-15.5 0.38-1.54	.028-.055 0.70-1.40	600-3000	.020 0.51	.110 2.79	.225 5.72	Tin Plated Brass	1217384-1*

\*These splices are recommended for applications using wire size 26 AWG [0.40 mm] or smaller.

**5 Serrations — Thru Type**

**Product Facts**

- Wide range of thru splice s
- Serrations centered in splice to achieve optimum electrical and mechanical performance in a thru splice
- CMA range accepts a wide variety of wire sizes and combinations

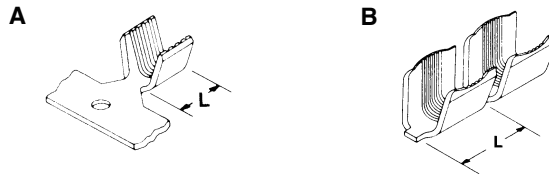

Type	AWG/ mm <sup>2</sup>	Wire Range Solid Dia.	Wire Range CMA	Stock Thickness	Crimp Width	Dim. L	Material	Part Number
A	17-12.5 1.00-2.80	.045-.075 1.15-1.85	2000-5400	.020 0.51	.110 5.08	.235 5.97	Brass	63564-1
	10-8 5.00-8.00	.100-.125 2.55-3.20	10,000-16,000	.032 0.80	.180 4.57	.267 6.78	Tin Plated Brass	63561-1
	10-7.5 5.00-11.50	.100-.150 2.60-3.80	10,400-22,900	.030 0.76	.300 7.62	.310 7.87	Tin Plated Brass	63562-1
	22-15.5 0.38-1.54	.028-.055 0.70-1.40	600-3000	.020 0.51	.110 2.79	.225 5.72	Brass	42076
B	22-15.5 0.38-1.54	.028-.055 0.70-1.40	600-3000	.020 0.51	.110 2.79	.225 5.72	Brass	42192-1*
	22-15.5 0.38-1.54	.028-.055 0.70-1.40	600-3000	.020 0.51	.110 2.79	.225 5.72	Tin Plated Brass	42192-2*
	22-15.5 0.38-1.54	.028-.055 0.70-1.40	600-3000	.020 0.51	.110 2.79	.225 5.72	Brass	42778-1* <sup>1</sup>
	22-15.5 0.38-1.54	.028-.055 0.70-1.40	600-3000	.020 0.51	.110 2.79	.225 5.72	Tin Plated Brass	42778-2* <sup>1</sup>
	18.5-13.5 0.80-2.54	.039-.071 1.00-1.80	1500-5000	.020 0.51	.110 2.79	.225 5.72	Brass	41765
	18.5-13.5 0.80-2.54	.039-.071 1.00-1.80	1500-5000	.020 0.51	.110 2.79	.225 5.72	Tin Plated Brass	41899
	18.5-13.5 0.80-2.54	.039-.071 1.00-1.80	1500-5000	.020 0.51	.110 2.79	.225 5.72	Brass	42119-1*
	18.5-13.5 0.80-2.54	.039-.071 1.00-1.80	1500-5000	.020 0.51	.110 2.79	.225 5.72	Brass	42776-1* <sup>1</sup>
	18.5-13.5 0.80-2.54	.039-.071 1.00-1.80	1500-5000	.020 0.51	.110 2.79	.225 5.72	Tin Plated Brass	42776-2* <sup>1</sup>
	15.5-12 1.54-3.46	.055-.083 1.40-2.10	3000-7000	.020 0.51	.140 3.56	.225 5.72	Brass	41766
	15.5-12 1.54-3.46	.055-.083 1.40-2.10	3000-7000	.020 0.51	.140 3.56	.225 5.72	Tin Plated Brass	41900
	15.5-12 1.54-3.46	.055-.083 1.40-2.10	3000-7000	.020 0.51	.140 3.56	.225 5.72	Brass	42779-1 <sup>1</sup>
	15.5-12 1.54-3.46	.055-.083 1.40-2.10	3000-7000	.020 0.51	.140 3.56	.225 5.72	Tin Plated Brass	42779-2 <sup>1</sup>
	12-10 3.46-6.00	.083-.110 2.10-2.80	7000-12,000	.025 0.64	.250 6.35	.225 5.72	Tin Plated Brass	61074-11. <sup>2</sup>
	12-9 3.46-6.38	.083-.112 2.10-2.85	7000-13,000	.025 0.64	.180 4.57	.225 5.72	Brass	41770
	12-9 3.46-6.38	.083-.112 2.10-2.85	7000-13,000	.025 0.64	.180 4.57	.225 5.72	Tin Plated Brass	41904
12-9 3.46-6.38	.083-.112 2.10-2.85	7000-13,000	.025 0.64	.180 4.57	.225 5.72	Brass	42780-1 <sup>1</sup>	
12-9 3.46-6.38	.083-.112 2.10-2.85	7000-13,000	.025 0.64	.180 4.57	.225 5.72	Tin Plated Brass	42780-2 <sup>1</sup>	

\* These splices are recommended for applications using wire size 26 AWG [0.40 mm] or smaller.

<sup>1</sup> Increased terminal pitch.

<sup>2</sup> Increased U-diameter.

**AMPLIVAR Splices** (Continued)

**5 Serrations — Pigtail Type**

**Product Facts**

- Serration depths are varied within the splice to give optimum electrical / mechanical performance on all wire sizes
- Flat bottom of splice helps keep magnet wires on bottom as required during crimping



AWG/ mm <sup>2</sup>	Wire Range Solid Dia.	Wire Range CMA	Stock Thickness	Crimp Width	Dim. L	Material	Part Number
20-17	.030-.045	1000-2000	.016	.100	.225	Tin Plated Brass	62670-2* <sup>1</sup>
0.50-1.00	0.80-1.15		0.41	2.54	5.72		

\*These splices are recommended for applications using wire size 26 AWG [0.40 mm] or smaller.  
<sup>1</sup> Flat bottom.

**Miniature Splice — Pigtail Type**

**Product Facts**

- The miniature AMPLIVAR splice was developed for crimping thinner copper magnet wires having a diameter between .003 and .016 [0.08 and 0.40 mm] and has to be connected with a stranded conductor
- The diameter of one conductor strand should not exceed the magnet wire diameter to be applied

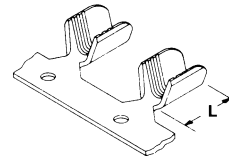

AWG/ mm <sup>2</sup>	Wire Range Solid Dia.	Wire Range CMA	Stock Thickness	Crimp Width	Dim. L	Material	Part Number
27-21	.014-.030	200-850	.012	.055	.195	Tin Plated Brass	63431-1
0.10-0.40	0.35-0.75		0.30	1.40	4.95		
25-18	.015-.045	300-1850	.012	.070	.195	Copper-Nickel	61166-1
0.16-0.90	0.45-1.10		0.30	1.78	4.95		
24-18.5	.020-.039	480-1500	.014	.080	.195	Tin Plated Brass	62341-1
0.20-0.75	0.55-1.00		0.36	2.03	4.95		
24-18.5	.020-.039	480-1500	.014	.080	.195	Brass	62341-2
0.20-0.75	0.55-1.00		0.36	2.03	4.95		
24-18	.020-.040	480-1700	.016	.070	.195	Brass	62044-1
0.20-0.80	0.55-1.00		0.41	1.78	4.95		

**Subminiature Splice — Thru or Pigtail Type**

**Product Facts**

- The compactness of these splices makes them ideal for use in small subfractional motors, transformers, relays, solenoids, indicator lamps and small appliance terminations
- These splices provide the same reliability as the larger AMPLIVAR splices

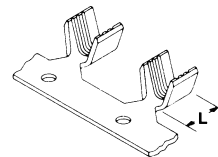

AWG/ mm <sup>2</sup>	Wire Range Solid Dia.	Wire Range CMA	Stock Thickness	Crimp Width	Dim. L	Material	Part Number
30-26	.010-.015	100-300	.010	.042	.080	Tin Plated Brass	63621-2
0.05-0.15	0.30-0.50		0.25	1.08	2.03		
24-19	.020-.035	400-1300	.016	.070	.100	Tin Plated Brass	62194-2
0.26-0.60	0.55-0.90		0.41	1.78	2.54		
24-19	.020-.035	400-1300	.016	.070	.100	Gold Plated Brass	62194-4
0.26-0.60	0.55-0.90		0.41	1.78	2.54		

AMPLIVAR Splice

## AMPLIVAR Terminals

### Products Facts

- Ring tongue terminals available for 2 to 3/8 stud diameters
- FASTON tab terminals accept .125 [3.18], .187 [4.75] and .250 [6.35] receptacle terminals
- FASTON receptacle terminals accept .187 [4.75] and .250 [6.35] tab terminals
- FASTON stator receptacle accept .250 x .032 [6.35 x 0.81] tab terminal
- Pin receptacle terminals accept .062 [1.57] and .090 [2.29] diameter pins



### Applications

- Motor windings
- Transformers
- Power supplies
- Starters and alternators

AMPLIVAR magnet wire terminals are designed to terminate copper and/or aluminum magnet wire. Terminals are insulation displacing; therefore, magnet wires do not require a separate prestripping operation.

The unique wire barrel design, with serrations and burrs, produces a superior metal-to-metal compression crimp with excellent tensile strength.

Terminals are available in a variety of ring tongue, FASTON straight, flag and stator receptacles and tab quick-disconnect style terminals.

Direct connection to magnet wire eliminates the need for separate stranded wire terminal connection to input/output devices.

Matched with automated application tooling allows high production rates for stripform terminals.

**Product specifications** describe the product qualification test results completed by TE for consideration of product use in a specific application. They are intended for the Design and Product Reliability Engineer.

108-16000 —AMPLIVAR ring tongue terminals

108-1718 —AMPLIVAR .125 blade terminals [Type A]

### Technical Documents

**Application Specifications** describe requirements for using the product in its intended application and or crimping information. They are intended for the Packaging and Design Engineer and the Machine Setup Person.

114-2145 AMPLIVAR .125 Blade Terminals  
 114-2146 AMPLIVAR FASTIN-FASTON Series 187 Tab Terminals  
 114-2070 AMPLIVAR FASTON Series 250 Tab Terminals

114-2144 AMPLIVAR FASTON Series .250 Straight Receptacle Terminals  
 114-2152 AMPLIVAR Flag FASTON Series 187 & 250 Receptacle Terminal

114-2080 AMPLIVAR Pin Receptacle Terminals [Type A]  
 114-2128 AMPLIVAR Stator Receptacle with FASTON Mating End

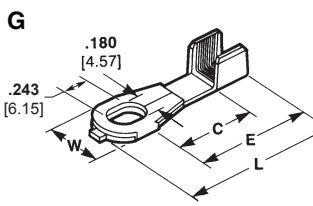
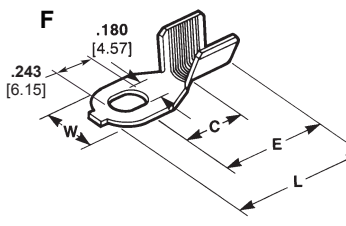
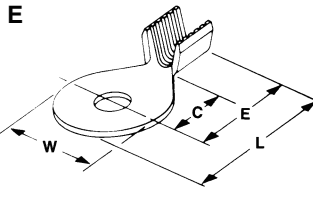
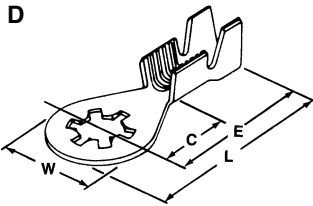
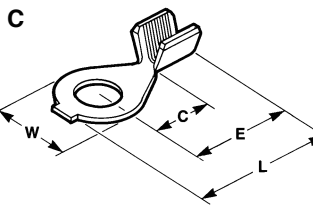
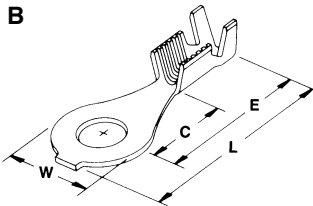
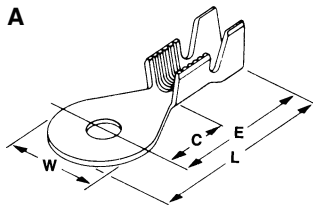

**AMPLIVAR Terminals** (Continued)

**Ring Tongue Terminals**

**Wire Size Range 29–22 AWG [0.287–0.643 mm]**

Type	Insulation Dia. Range	Hole Dia.	Stud Size	Stock Thk.	Material	Dimensions				Part Number
						W	L	E	C	
B	.040-.060 1.02-1.52	.197 5	10	.020 0.51	Tin Plated Brass	.342 8.69	.833 21.16	.662 16.81	.312 7.92	63399-1

**Wire Size Range 23–19 AWG [0.574–0.912 mm]**

Type	Insulation Dia. Range	Hole Dia.	Stud Size	Stock Thk.	Material	Dimensions				Part Number
						W	L	E	C	
B	.100-.140 2.54-3.56	.171 4.34	8	.020 0.51	Tin Plated Brass	.342 8.69	.833 21.16	.662 16.81	.312 7.92	60321-2
A	.125-.165 3.18-4.19	.171 4.34	8	.020 0.51	Tin Plated Brass	.300 7.62	.700 17.78	.550 13.97	.230 5.84	60323-2
B	.100-.140 2.54-3.56	.197 5	10	.020 0.51	Tin Plated Brass	.342 8.69	.833 21.16	.662 16.81	.312 7.92	60319-2
A	.125-.165 3.18-4.19	.197 5	10	.020 0.51	Tin Plated Brass	.300 7.62	.695 17.65	.545 13.84	.230 5.84	60325-2

**Wire Size Range 22–18 AWG [0.643–1.024 mm]**

Type	Insulation Dia. Range	Hole Dia.	Stud Size	Stock Thk.	Material	Dimensions				Part Number
						W	L	E	C	
B	.125-.165 3.18-4.19	.265 6.73	1/4	.025 0.64	Tin Plated Brass	.420 10.67	.872 22.15	.662 16.81	.312 7.92	63612-1
E	—	.145 3.58	6	.025 0.64	Tin Plated Brass	.290 7.37	.500 12.7	.355 9.02	.195 4.95	63649-1
C	—	.265 6.73	1/4	.025 0.64	Tin Plated Brass	.420 10.67	.702 17.83	.492 12.5	.312 7.92	62835-1
E	—	.171 4.34	8	.025 0.64	Brass Tin Plated Brass	.290 7.37	.500 12.7	.355 9.02	.195 4.95	63446-1 63446-2

**Wire Size Range 20–16 AWG [0.813–1.29 mm]**

Type	Insulation Dia. Range	Hole Dia.	Stud Size	Stock Thk.	Material	Dimensions				Part Number
						W	L	E	C	
A	.125-.165 3.18-4.19	.171 4.34	8	.020 0.51	Tin Plated Brass	.300 7.62	.695 17.65	.545 13.84	.230 5.84	60322-2
H	—	—	8	.020 0.51	Brass	.340 8.64	1.220 30.98	.660 16.76	.500 12.7	505071-1
L	—	—	3/8	.020 0.51	Brass	.625 15.88	.939 23.85	.627 15.93	.467 11.86	505075-1
M	—	—	3/8	.020 0.51	Brass	.645 16.38	.950 24.12	.627 15.93	.467 11.86	505072-1

**Wire Size Range 18–14 AWG [1.024–1.628 mm]**

Type	Insulation Dia. Range	Hole Dia.	Stud Size	Stock Thk.	Material	Dimensions				Part Number
						W	L	E	C	
B	.100-.140 2.54-3.56	.171 4.34	8	.020 0.51	Brass	.342 8.69	.833 21.16	.662 16.81	.312 7.92	60320-1
	.100-.140 2.54-3.56	.171 4.34	8	.020 0.51	Tin Plated Brass	.342 8.69	.833 21.16	.662 16.81	.312 7.92	60320-2
D	.100-.140 2.54-3.56	.197 5	10	.020 0.51	Brass	.342 8.69	.833 21.16	.662 16.81	.312 7.92	60318-1
	.080-.120 2.03-3.05	.173 4.39	8	.028 0.71	Lu-Bronze <sup>1</sup>	.370 9.4	.915 23.24	.730 18.54	.380 9.65	485079-1
D	.080-.120 2.03-3.05	.185 4.7	8	.028 0.71	Lu-Bronze <sup>1</sup>	.365 9.27	.882 22.4	.700 17.78	.380 9.65	485044-1

<sup>1</sup>High conductivity copper-tin-zinc alloy.

**Wire Range 17–13.5 AWG [1.151–1.78 mm]**

Type	Insulation Dia. Range	Hole Dia.	Stud Size	Stock Thk.	Material	Dimensions				Part Number
						W	L	E	C	
F	—	—	8	.020 0.51	Brass	.310 7.87	.692 17.58	.505 12.83	.312 7.92	63147-1
	—	—	8	.020 0.51	Tin Plated Brass	.310 7.87	.692 17.58	.505 12.83	.312 7.92	63147-2*

\*Available on request

**Wire Size Range 14–12 AWG [1.628–2.05 mm] or (2) 15 AWG [1.45 mm]**

Type	Insulation Dia. Range	Hole Dia.	Stud Size	Stock Thk.	Material	Dimensions				Part Number
						W	L	E	C	
G	—	—	8	.025 0.64	Brass	.342 8.69	.945 24.00	.750 19.05	.570 14.48	62755-1

Dimensions are in inches and millimeters unless otherwise specified. Values in brackets are metric equivalents.

Dimensions are shown for reference purposes only. Specifications subject to change.

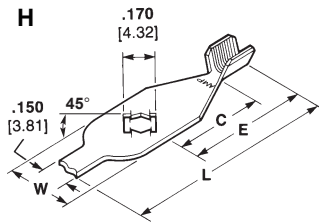
**AMPLIVAR Terminals (Continued)**
**Stud Retaining Terminals**

**Wire Size Range 13–11 AWG [1.83–2.3 mm]**

Type	Insulation Dia. Range	Hole Dia.	Stud Size	Stock Thk.	Material	Dimensions				Part Number
						W	L	E	C	
A	.085-.150 2.16-3.81	.180 4.57	8	.025 0.64	Brass	.342 8.69	.833 21.16	.662 16.81	.312 7.92	61710-1
C	—	.180 4.57	8	.025 0.64	Tin Plated Brass	.342 8.69	.665 16.89	.495 12.57	.312 7.92	350571-1
		.197 5.00	10	.025 0.64	Tin Plated Brass	.342 8.69	.665 16.89	.495 12.57	.312 7.92	640212-1

**Wire Range (1) 18 AWG [1.024 mm] and (1) 20.5 AWG [0.768 mm]**

Type	Insulation Dia. Range	Hole Dia.	Stud Size	Stock Thk.	Material	Dimensions				Part Number
						W	L	E	C	
J	—	—	8	.020 0.51	Brass	.340 8.64	.955 24.26	.660 16.76	.500 12.7	505044-1

**Wire Range (2) 17 AWG [1.51 mm] or (2) 15 AWG [1.45 mm]**

Type	Insulation Dia. Range	Hole Dia.	Stud Size	Stock Thk.	Material	Dimensions				Part Number
						W	L	E	C	
B	.150-.190 or (2) .115 3.18-4.83 or (2) 2.92	.171 4.34	8	.025 0.64	Tin Plated Brass	.342 8.69	.827 21.01	.656 16.66	.312 7.92	60752-2
										.197 5.00

**Wire Range 16–13.5 AWG [1.29–1.78 mm]**

Type	Insulation Dia. Range	Hole Dia.	Stud Size	Stock Thk.	Material	Dimensions				Part Number
						W	L	E	C	
K	—	—	10	.020 0.51	Brass	.340 8.64	1.220 30.99	.660 16.76	.500 12.7	505079-1

**Wire Range 14.5 AWG [1.539 mm]**

Type	Insulation Dia. Range	Hole Dia.	Stud Size	Stock Thk.	Material	Dimensions				Part Number
						W	L	E	C	
N	—	—	2	.025 0.64	Tin Plated Brass	.240 6.1	.620 15.75	.500 12.7	.165 4.19	505036-1
										.025 0.64

**Alternator Eyelet Terminal**

**Wire Range (2) 13 AWG [1.83 mm]**

Type	Insulation Dia. Range	Hole Dia.	Stud Size	Stock Thk.	Material	Dimensions				Part Number
						W	L	E	C	
B	.150-.190 3.81-4.83	.171 4.34	8	.025 0.64	Tin Plated Brass	.342 8.69	.827 21.00	.656 16.66	.312 7.92	63864-1

**AMPLIVAR Terminals** (Continued)

**125 Series Blade**

**Stock Thickness**

A = .013 [0.33]

B = .020 [0.51]

Mates with power blade receptacle terminals 61603-1, 61604-1, 770642-1 and 1217039-1

**Housings**

Contact TE engineering for housing options available



Type	Magnet Wire Range				Material	Material Thickness	Part Number
	AWG	mm <sup>2</sup>	Solid Dia.	CMA			
A	27-20.5	0.10-0.45	.015-.030 0.35-0.75	200-850	Tin Plated Brass	.013 0.33	63871-1
	24-18	0.2-0.8	.020-.040 0.50-1.00	400-1600	Tin Plated Brass	.013 0.33	63889-1
	18.5-13.5	0.75-2.5	.040-.070 0.50-1.80	1500-5000	Tin Plated Brass	.016 0.41	63870
B	27-20.5	0.10-0.45	.015-.030 0.35-0.75	200-850	Tin Plated Brass	.013 0.33	1217072-1
	24-18	0.2-0.8	.020-.040 0.50-1.00	400-1600	Tin Plated Brass	.020 0.51	1217029-1
	18.5-13.5	0.75-2.5	.040-.070 0.50-1.80	1500-5000	Tin Plated Brass	.020 0.51	1217073-1

**187 Series FASTON Tabs<sup>1</sup>**

**Board Thickness**

A = .062-.072 [1.57-1.83]

**Stock Thickness**

A = .020 [0.51]

B = .032 [0.81]



Type	Wire Range		Material	Dim. L	Part Number
	AWG	mm <sup>2</sup>			
B	27-23	0.1-0.2	Tin Plated Brass	.935 23.75	63484-1 <sup>2</sup>
	24-21	0.2-0.4	Tin Plated Brass	.935 23.75	61440-3†
A	22-16	0.3-1.4	Tin Plated Brass	1.015 25.78	62447-1
	15-13	1.6-2.6	Tin Plated Brass	.935 23.75	61442-3†
	15-12	1.6-3.0	Tin Plated Brass	1.015 25.78	62445-1

<sup>2</sup> Varnish resist coating.

† These part numbers are available upon special request, contact TE engineering for details.

**250 Series FASTON Tabs<sup>1</sup>**

**Stock Thickness**

.032 [0.81]

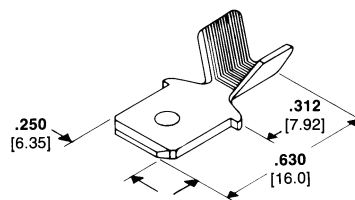

Wire Range		Material	Part Number	Quick-Change Applicator <sup>3</sup>
AWG	mm <sup>2</sup>			
14-12	2.0-3.0	Tin Plated Brass	62922-12	466510-1

<sup>2</sup> Varnish resist coating.

<sup>3</sup> Quick-change applicator for AMP-O-LECTRIC machine 565435-5. For AMPOMATOR machine and other machines not listed, contact TE.

<sup>1</sup>Mates with FASTON receptacles. See Catalog 82004.

**AMPLIVAR Terminals** (Continued)

**250 Series FASTON Tabs<sup>1</sup>**

(Continued)

**Stock Thickness**

.032 [0.81]

Mates with FASTON receptacles.  
See Catalog 82004.

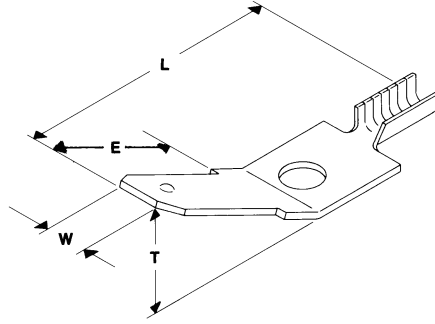

Wire Range		Material	Dimensions				Part Number
AWG	mm <sup>2</sup>		W	L	E	T	
28-23.5	0.08-0.2	Tin Plated Brass	.250 6.35	.580 14.73	.342 8.69	45°	63136-1
25-19.5	0.16-0.6	Tin Plated Brass	.250 6.35	.650 16.51	.450 11.43	30°	63140-1
23-19	0.2-0.6	Tin Plated Brass	.250 6.35	.225 5.72	.583 14.81	15°	63165-1

**250 Series FASTON Receptacles<sup>1</sup>**

**Stock Thickness**

.016 [0.41]

Mates with FASTON tabs.  
See catalog 82004.



Magnet Wire Range		Insulation Diameter	Mating Tab Thk.	Material	Material Thickness	Part Number	Applicator No.
CMA	mm <sup>2</sup> Dia.						
24-19	0.51-0.98	.050-.080 1.30-2.00	.020 0.51	Brass Tin Plated Brass	.016 0.41	63623-1 <sup>1</sup> 63623-2 <sup>1</sup>	567451-2 <sup>2</sup>
23-19 or (2) 24 or (2) 26	0.60-0.98 or (2) 0.57 or (2) 0.45	.050-.100 1.30-2.55	.025 0.64	Brass	.016 0.41	62069-1	567343-2 <sup>2</sup>
20-16 or (2) 23 or (2) 20	0.85-1.37 or (2) 0.63 or (2) 0.88	.100-.140 or (2) .060 Max. 2.55-3.55	.032 [0.81]	Brass Tin Plated Brass	.016 0.41	60384-1 60384-2	466010-1 <sup>2</sup>
20-16	0.85-1.37	.100-.140 2.55-3.55	.020 0.51	Brass	.016 0.41	62080-1	466010-1 <sup>2</sup>
18-14 or (2) 17	1.02-1.71	.120-.170 or (2) .060 Max. 3.05-4.30	.032 [0.81]	Tin Plated Brass	.016 0.41	60385-2	466816-1 <sup>2</sup>
18-14 or (2) 19	1.02-1.71	.120-.170 3.05-4.30	.020 0.51	Brass	.016 0.41	63622-1 <sup>1</sup>	466816-1 <sup>2</sup>
18-14 or (2) 19	1.02-1.71	.120-.170 3.05-4.30	.020 0.51	Brass	.016 0.41	1217835-1 <sup>1</sup>	466816-1 <sup>2</sup>

<sup>1</sup> Low insertion force

<sup>2</sup> Quick-change applicator for AMP-O-LECTRIC machine 565435-5.

**AMPLIVAR Terminals** (Continued)

**187 Series FASTON Flag Receptacles**

**Stock Thickness**

.016 [0.41]



Magnet Wire Range CMA	mm <sup>2</sup> Dia.	Insulation Diameter	Mating Tab Thk.	Material	Material Thickness	Part Number	Applicator No.
500-960	0.56-0.79	.020-.040 0.51-1.02	.020 0.51	Tin Plated Brass	.016 0.41	63942-1	566411-11
24-20 AWG	0.51-0.81	.020-.040 0.51-1.02	.032 0.81	Tin Plated Brass	.016 0.41	1217624-1	566411-11
1500-2350	0.99-1.22	.020-.040 0.51-1.02	.020 0.51	Tin Plated Brass	.016 0.41	63941-1	566410-11
2000-4050	1.14-1.63	.020-.040 0.51-1.02	.020 0.51	Tin Plated Brass	.016 0.41	63940-1	680353-3 <sup>2</sup>
2000-4050	1.14-1.63	.020-.040 0.51-1.02	.032 0.81	Tin Plated Brass	.016 0.41	1217417-1	680353-3 <sup>2</sup>

<sup>1</sup> Standard applicator for AMP-O-LECTRIC Model G splice terminator No. 356462-2.  
<sup>2</sup> Quick-change applicator for AMP-O-LECTRIC Model G splice terminator No. 356462-1.

**250 Series FASTON Flag Receptacles**

**Stock Thickness**

.018 [0.45]

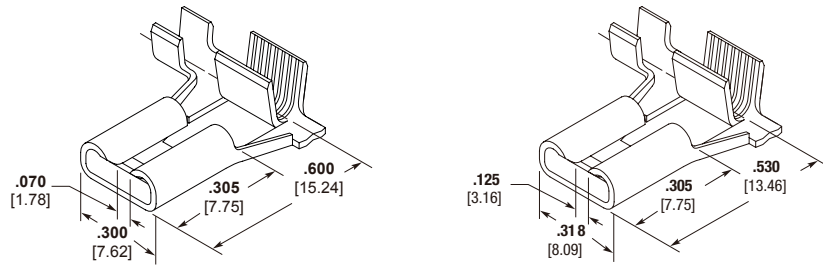

Magnet wire range CMA	mm <sup>2</sup> Dia.	Insulation Diameter	Mating Tab Thk.	Material Thickness	Part Number	Applicator No.
500-1900	—	.100-.120 2.54-3.05	6.35 0.81	0.0157 0.4	1742881-1	1855633
1000-2700	—	.100-.120 2.54-3.05	6.35 0.81	0.0157 0.4	1742882-1	1855634
1500-4220	—	.075-.125 1.90-3.18	6.35 0.81	0.0157 0.4	1742977-1	1855680
4000-8500	—	.110-.150 2.79-3.81	6.35 0.81	0.0157 0.4	1742979-1	1855681

<sup>1</sup> Quick-change applicator for AMP-O-LECTRIC Model G splice terminator No. 356462-1.

**Pin Receptacles**

**Stock Thickness**

.016 [0.41]

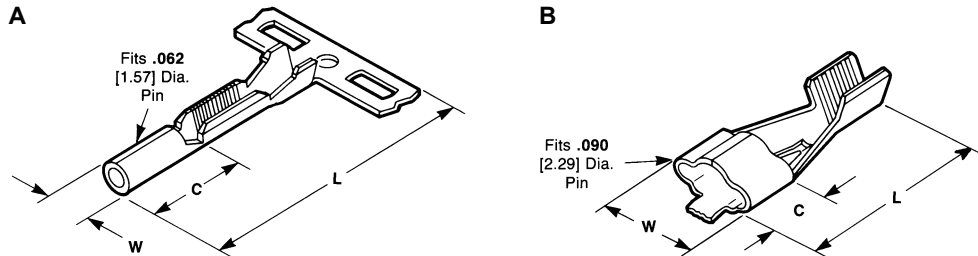

Type	Wire Range		Insulation Dia. Range	Material	Dimensions			Part Number
	AWG	mm <sup>2</sup>			W Max.	L	C	
A	29-22	0.07-0.3	.040-.060 1.02-1.52	Tin Plated Brass	.084 2.13	.590 14.99	.195 4.95	63506-1
B	21-16	0.4-1.4	—	Tin Plated Phos. Bronze	.235 5.97	.660 16.76	.250 6.35	60177-2

**AMPLIVAR Terminals** (Continued)

**250 Series Stator Receptacles — 7 Serrations**

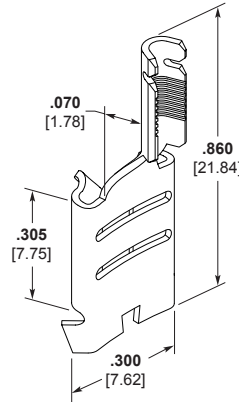

AWG	Magnet Wire Range		CMA	Mating Tab Thickness	Stock Thickness	Crimp Width	Material	Part Number
	mm <sup>2</sup>	Solid Dia.						
27-22	0.10-0.3	.014-.026 0.35-0.66	200-700	.032 0.81	.018 0.44	.070 1.77	Tin Plated Brass	63480-1
21-15	0.4-1.6	.028-.060 0.71-1.52	800-3600	.032 0.81	.018 0.44	.110 2.79	Tin Plated Brass	62381-1
22-15.5	0.3-1.5	.053-.086 1.35-2.18	2800-7400	.032 0.81	.018 0.44	.155 3.94	Tin Plated Brass	63964-1

**Stator Terminal — Receptacle .250 x .032 [6.35 x 0.81]**

- ① **Stator Terminal** with Receptacle .250 x .032 [6.35 x 0.81]
- ② **Plastic Cavity**  
Production only according to TE Specifications (contact TE engineering for details).  
For design and material selection TE engineering **has to be** contacted before decision. The terminal is separated from the strip and placed automatically into the cavity.



- ③ **Wire Clamping Barrel**  
The magnet wire is positioned via posts into the AMPLIVAR crimp barrel and fixed inside clamping barrel.
- ④ **AMPLIVAR Terminal Crimp**  
The application equipment crimps the AMPLIVAR product connection and cuts the extending clamping barrel in one operation.

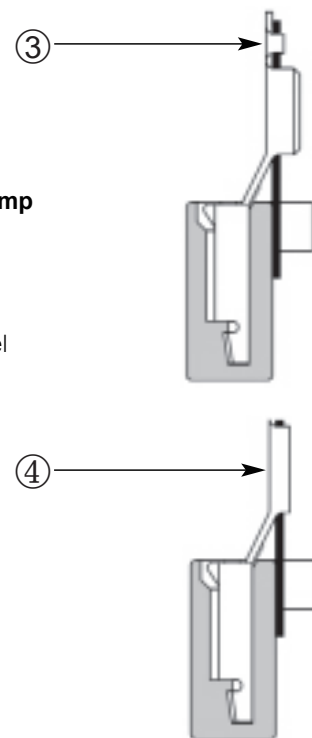

**Additional versions upon request.**  
**Application tooling for production line integrating available upon request.**



## Cluster Blocks

### Product Facts

- Connects to sealed hermetic headers
- Versions available to accept 2.29 [.090] and 3.18 [.125] header pins
- Accepts Lead wire range 18–16 AWG [0.8–1.4 mm<sup>2</sup>] and 14–12 AWG [2.0–3.0 mm<sup>2</sup>]
- AMPLIVAR product versions accept up to 3 copper or aluminum magnet wires without the need to remove insulation
- Impervious to many oils and refrigerants
- Insulation compatibility
- Housings available to accept standard and reversed header pin layouts
- Housing versions available for compressor interior and exterior
- High-performance electrical and mechanical contact
- High-impact resistant
- Assemblies accept pins from one side only to prevent reversed polarity
- High-speed application of pin receptacle terminals with automatic terminating machines and quick-change applicators for high volume production rates at the lowest installed cost
- Recognized under the Component Program of Underwriters Laboratories Inc., File No. E28476



TE features cluster blocks that offer manufacturers of air conditioning and refrigeration products a low-cost, fully insulated, quick-connect means for electrically connecting sealed hermetic header pins on compressors.

Cluster blocks feature high impact resistance to shock and abuse, and long-life performance in the presence of oils and refrigerants. Since the connectors accept pins from only one side, the danger of reversing polarity at the time of installation is prevented.



The one-piece housings are molded from thermoplastic polyester. The connector accepts 2.29 [.090] and 3.18 [.125] diameter pin sizes in either standard or reverse pin layouts.

Housings accept both lead wire and AMPLIVAR direct connect pin receptacle

terminals. These are precision formed and available on reels for highspeed application.

High retention pin receptacle terminals are available to provide optimum terminal retention housings.



Typical Assembly

PRODUCT SPECIFICATIONS:  
108-2008,108-5205 & 108-5541

APPLICATION SPECIFICATIONS:  
114-2019 & 114-5235



**Cluster Blocks 2.29 [.090] Pin Size (Lead Wire and Direct Connect)**

**Housings**

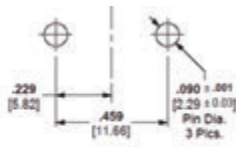

**Pin Location A**

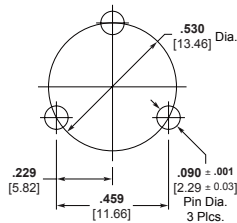

**Pin Location B, C and D**

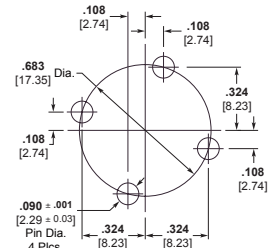

**Pin Location E**

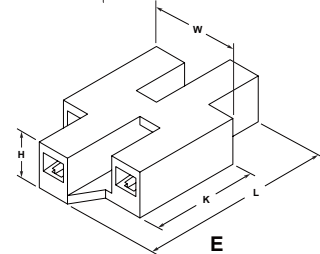
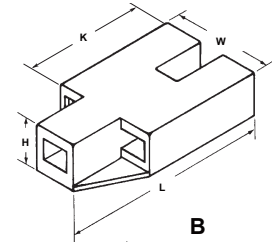
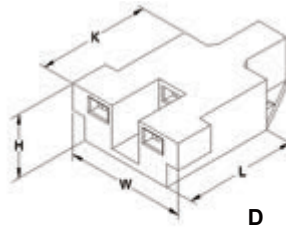
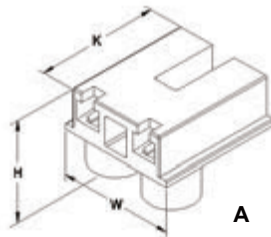
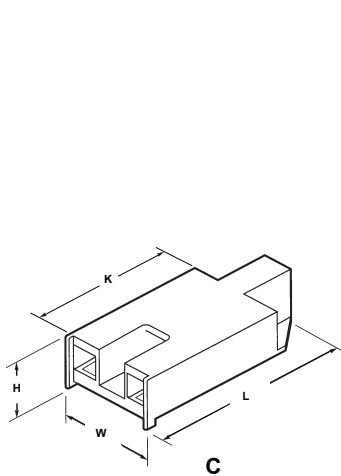

Type	Header Pin Circle Dia.	Dim L	Dim W	Dim H	Dim K	Material / Use <sup>1</sup>	Accepts Receptacle Style	Part Number	Notes
	mm / inch	mm / inch	mm / inch	mm / inch	mm / inch				
2 Position with Standoff	13.46 [.530]	22.45 [.884]	21.08 [.830]	14.23 [.560]	N/A	PBT Interior	A, B & C	1969357-1	
		31.50 [1.240]	18.05 [.710]	8.15 [.320]	21.35 [.840]	PBT Interior	A, B & C	360050-1	
		31.00 [1.220]	17.65 [.695]	6.60 [.260]	20.85 [.820]	PBT Interior	A, B & C	521078-1	
B 3 Position Center Forward	13.46 [.530]	30.48 [1.200]	17.65 [.695]	7.87 [.310]	20.40 [.803]	PBT Exterior	A, B & C	1380145-1	2
		30.48 [1.200]	17.65 [.695]	7.87 [.310]	20.40 [.803]	PBT Exterior	A, B & C	1380145-2	3
		30.48 [1.200]	17.65 [.695]	9.70 [.382]	20.40 [.803]	PBT Exterior	A, B & C	2232327-1	3
		30.48 [1.200]	17.65 [.695]	9.70 [.382]	20.40 [.803]	PA6+GF Exterior	A, B & C	2232327-2	4
		30.48 [1.200]	17.65 [.695]	9.70 [.382]	20.40 [.803]	PBT Exterior	A, B & C	2232326-1	3
		30.48 [1.200]	17.65 [.695]	9.70 [.382]	20.40 [.803]	PA6+GF Exterior	A, B & C	2232326-2	4
C 3 Position Center Back	13.46 [.530]	30.80 [1.21]	17.80 [.701]	7.40 [.0291]	20.40 [.803]	PBT Exterior	A, B & C	235280-1	
		31.10 [1.225]	20.55 [.810]	8.15 [.320]	21.35 [.840]	PBT Interior	A, B & C	360033-1	
		30.50 [1.200]	17.65 [.695]	7.85 [.310]	20.40 [.805]	PBT Interior	A, B & C	281006-4	
		30.50 [1.200]	17.70 [.697]	7.90 [.311]	20.40 [.805]	PBT Exterior	A, B & C	880631-5	2
		30.50 [1.200]	17.70 [.697]	7.80 [.307]	20.40 [.805]	PA6+GF Exterior	A, B & C	1955415-1	4
		31.60 [1.244]	22.70 [.893]	9.30 [.366]	21.50 [.846]	PBT Filled Interior	D & E	171370-3	
D 3 Position Center Back Extra Wide	13.46 [.530]	31.60 [1.244]	22.70 [.893]	9.30 [.366]	21.50 [.846]	PBT Filled Exterior	D & E	171370-5	3
		31.60 [1.244]	22.70 [.893]	9.30 [.366]	21.50 [.846]	PA6+GF Exterior	D & E	171370-6	4
		28.10 [1.110]	22.70 [.893]	7.60 [.299]	18.10 [.712]	PBT Filled Exterior	F	2825082-1	5
		28.10 [1.110]	22.70 [.893]	7.60 [.299]	18.10 [.712]	PBT Filled Exterior	F	2825082-2	4
Economy Models	13.46 [.530]	28.10 [1.110]	22.70 [.893]	7.60 [.299]	18.10 [.712]	PBT Filled Exterior	F	2825082-1	5
		28.10 [1.110]	22.70 [.893]	7.60 [.299]	18.10 [.712]	PBT Filled Exterior	F	2825082-2	4
E 4 Position	17.35 [.683]	37.85 [1.490]	22.85 [.900]	9.00 [.355]	21.45 [.845]	PBT Interior	A, B & C	1217262-1	

Notes: 1. Interior use designates that the material can be subjected to refrigerants and lubricants often found in a compressor. 3. Flammability rating UL94 V-0  
 Consult TE Connectivity Product specification for additional information. 4. Flammability rating UL94 V-0. Glow Wire compliant to 750°C with No Flame per IEC 60335-1.  
 2. Flammability rating UL94 V-2 5. Flammability rating UL94 HB

**Cluster Blocks 2.29 [.090] Pin Size (Lead Wire and Direct Connect)**

**Pin Receptacles**

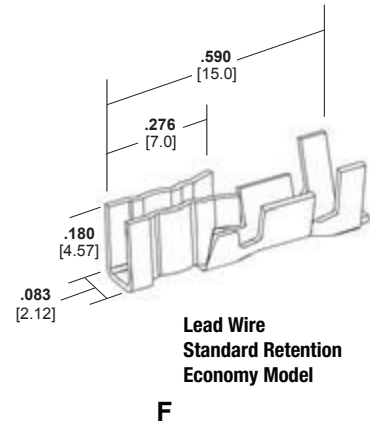
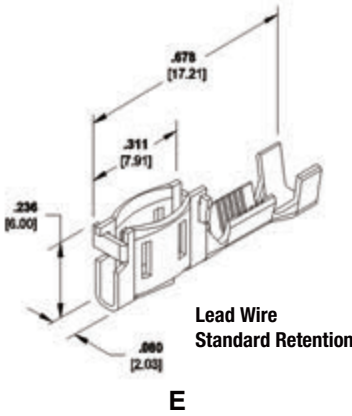
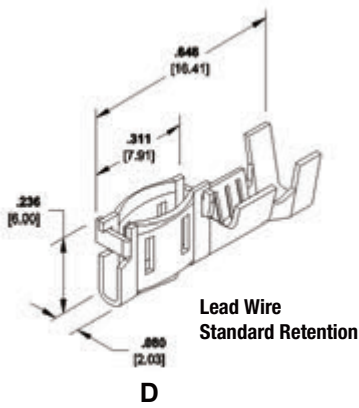
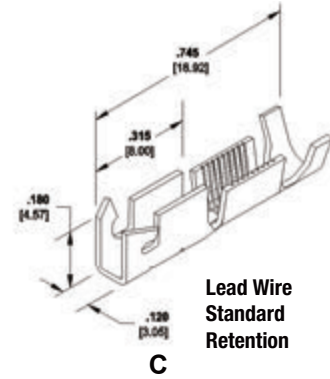
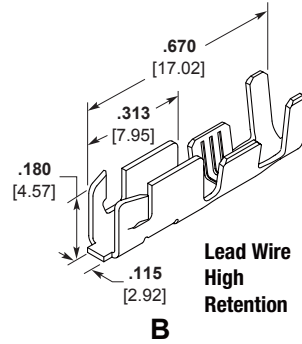
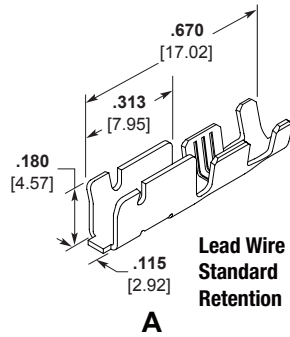

Cluster Blocks

Type	Lead Wire Size	Magnet Wire Size	Crimp Width	Insulation Dia	Crimp Width	Material	Part Number	Notes
	mm <sup>2</sup> / AWG	mm <sup>2</sup> / CMA						
A Lead Wire Standard Retention	0.30 - .75 [22 - 18]		2.03 0.080	1.30 - 2.40 .051 - .095	3.05 0.120	Tin Plated Phos Bronze <sup>1</sup>	1599105-1	
	0.80 - 1.3 [18 - 16]		2.79 0.110	1.50 - 2.50 .060 - .100	3.56 0.140	Tin Plated Phos Bronze <sup>1</sup>	62131-3	
			2.79 0.110	2.30 - 4.30 .090 - .170	4.57 0.180	Tin Plated Phos Bronze <sup>1</sup>	63448-1	
		0.26-0.77 [400 - 1600]	2.270 0.090	1.50 - 2.55 0.06 - .100	3.560 0.140	Tin Plated Phos Bronze <sup>1</sup>	1742981-1	
C AMPLIVAR Direct Connect High Retention Product		0.77 - 2.43 [1600 - 4800]	2.79 0.110	1.90 - 3.20 .075 - .125	3.94 0.155	Tin Plated Phos Bronze <sup>1</sup>	1742964-1	3
D Lead Wire Oval Contact	0.50 - 1.25 [20 - 16]		2.29 0.090	2.00 - 3.40 .080 - .134	3.81 0.150	Tin Plated Phos Bronze <sup>1</sup>	170063-2	2
E AMPLIVAR Short Barrel Oval Contact		0.11 - 0.73 [225 - 1445]	1.78 0.070	0.90 - 2.00 .035 - .079	3.3 0.130	Tin Plated Phos Bronze <sup>1</sup>	1123655-1	2, 4
		0.77 - 2.13 [1600 - 4200]	2.79 0.110	2.00 - 2.90 .080 - .114	3.81 0.150	Tin Plated Phos Bronze <sup>1</sup>	353937-1	2, 4
F Lead Wire Oval Contact Economy Model	0.50 - 1.25 [20 - 16]		2.29 0.090	2.00 - 3.40 .080 - .134	3.81 0.150	Tin Plated Phos Bronze <sup>1</sup>	2825083-1	5

Notes: 1. May contain an equivalent copper alloy.  
 2. Requires extra wide type D housing.  
 3. Connects up to 3 Copper or aluminum magnet wires without stripping insulation.  
 4. Connects up to 2 copper magnets without stripping insulation.  
 5. Requires extra wide type D, Economy Model housing.

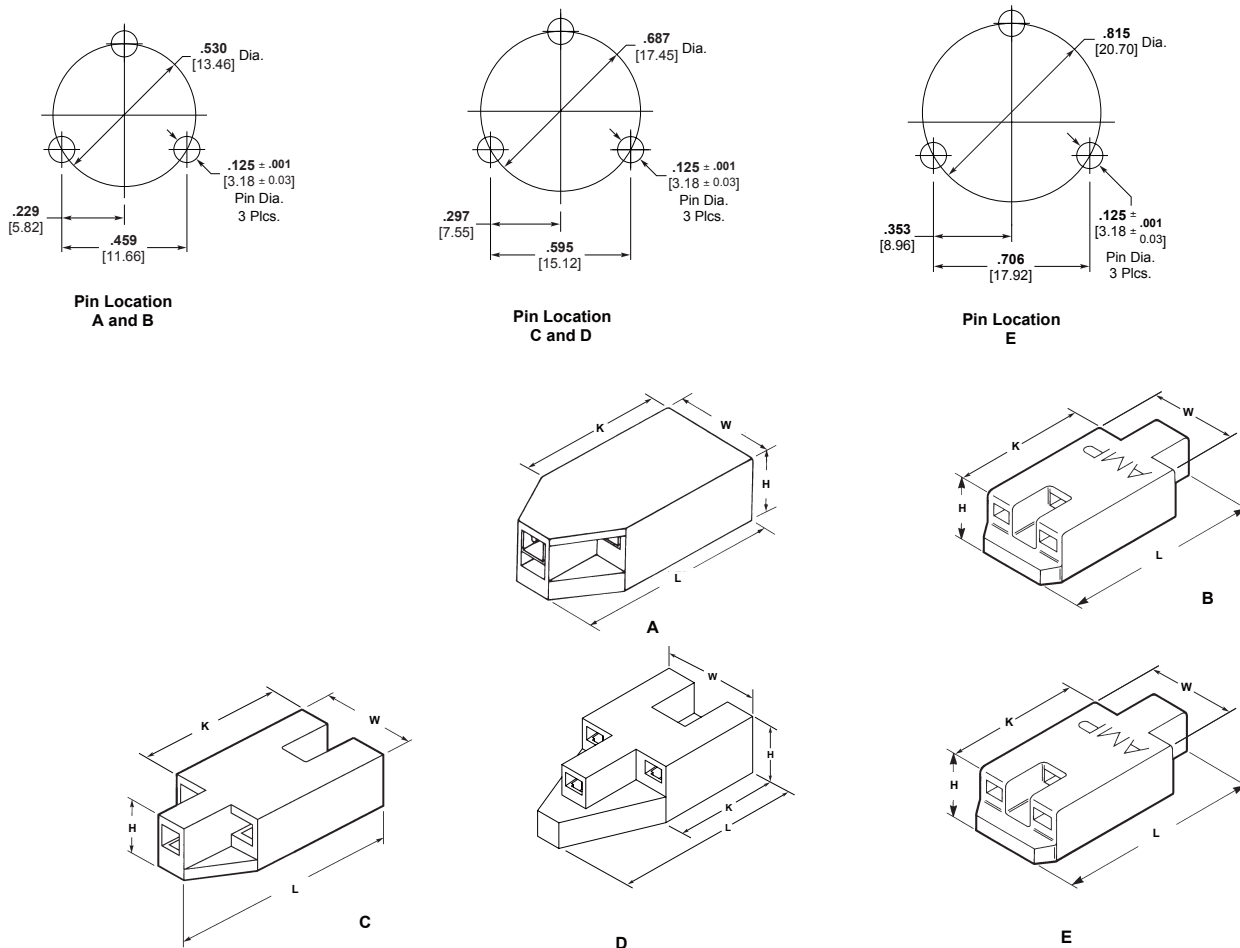
**Cluster Blocks 3.18 [.125] Pin Size (Lead Wire and Direct Connect)**
**Housings**

Type	Header Pin Circle Dia.	Dim L	Dim W	Dim H	Dim K	Material / Use <sup>1</sup>	Accepts Receptacle Style	Part Number
	mm / inch	mm / inch	mm / inch	mm / inch	mm / inch			
A 3 Position Center Forward	13.46 [.530]	44.60	19.45	11.95	31.17	PBT Interior	A, B, C & D	360052-1
		[1.755]	[0.765]	[0.470]	[1.227]	PBT Interior	A, B, C & D	1217181-1
B 3 Position Center Back	13.46 [.530]	44.60	19.45	11.95	31.10	PBT Interior	A, B, C & D	360051-1
		[1.755]	[0.765]	[0.470]	[1.225]	PBT Interior	A, B, C & D	1217200-1
C 3 Position Center Forward	17.45 [.687]	40.50	22.75	9.65	27.45	PBT Interior	A, B, C & D	520995-1
		[1.595]	[.895]	[.380]	[1.080]	PBT Interior	A, B, C & D	1217186-1
D 3 Position Center Back	17.45 [.687]	43.95	22.75	15.60	27.45	PBT Interior	A, B, C & D	1217187-1
		[1.730]	[.895]	[.615]	[1.080]	PBT Interior	A, B, C & D	1217187-1
E 3 Position Center Forward	20.70 [.815]	47.00	22.75	15.60	31.10	PBT Interior	A, B, C & D	1217187-1
		[1.850]	[.895]	[.615]	[1.225]	PBT Interior	A, B, C & D	1217261-1
E 3 Position Center Forward	20.70 [.815]	50.15	25.80	15.00	26.65	PBT Interior	A, B, C & D	1217261-1
		[1.975]	[1.015]	[.590]	1.05	PBT Interior	A, B, C & D	1217261-1

Notes: 1. Interior use designates that the material can be subjected to refrigerants and lubricants often found in a compressor. Consult TE Connectivity product specification for additional information.

**Cluster Blocks 3.18 [.125] Pin Size (Lead Wire and Direct Connect)** (Continued)

**Pin Receptacles**

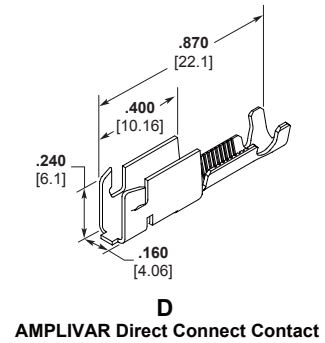
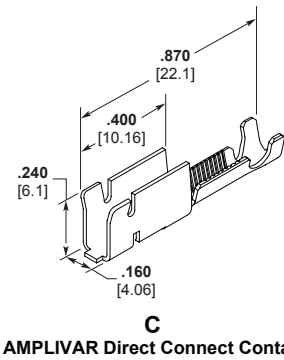
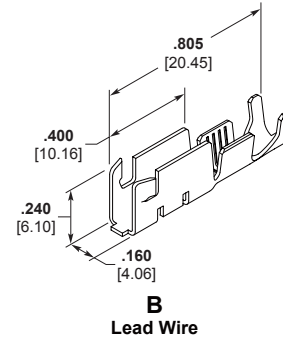
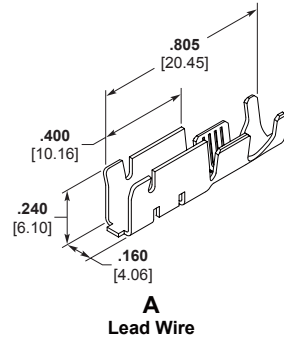

Type	Lead Wire Size	Magnet Wire Size	Crimp Width	Insulation Dia	Crimp Width	Material	Part Number	Notes
	mm <sup>2</sup> / AWG	mm <sup>2</sup> / CMA	mm / inch	mm / inch	mm / inch			
A Lead Wire Standard Retention	0.75 - 1.5 [18 - 16]		2.79 0.110	2.30 - 3.30 .090 - .130	3.94 0.155	Tin Plated Phos Bronze <sup>3</sup>	62244-3	2
	2.0 - 6.0 14 - 10		3.56 0.140	3.30 - 4.30 .130 - .170	4.57 0.180	Tin Plated Phos Bronze <sup>3</sup>	62243-3	2
	0.32-0.82 or 2x0.32 [22-18 or 2x22]		2.29 0.090	2.79 or 2x2.29 Max .110 or 2x.090 Max	3.56 0.140	Tin Plated Phos Bronze <sup>3</sup>	1742657-1	2
B Lead Wire High Retention	0.75 - 1.5 [18 - 16]		2.79 0.110	2.30 - 3.30 .090 - .130	3.94 0.155	Tin Plated Phos Bronze <sup>3</sup>	1217176-1	2
	2.0 - 6.0 [14 - 10]		3.56 0.140	3.30 - 4.30 .130 - .170	4.57 0.180	Tin Plated Phos Bronze <sup>3</sup>	1217175-1	2
		0.20 - 0.81 400 - 1600	2.27 0.090	1.50 - 2.55 .060 - .100	3.56 0.140	Tin Plated Phos Bronze <sup>3</sup>	63453-1	2, 4
C AMPLIVAR Direct Connect Standard Retention		0.76 - 2.13 1500 - 4200	2.79 0.110	1.90 - 3.20 .075 - .125	3.94 0.155	Tin Plated Phos Bronze <sup>3</sup>	63454-1	2, 4
		2.00 - 4.30 4000 - 8500	3.56 0.140	2.30 - 4.30 .090 - .170	4.32 0.170	Tin Plated Phos Bronze <sup>3</sup>	63455-1	2, 4
		0.20 - 0.81 400 - 1600	2.27 0.090	1.50 - 2.55 .060 - .100	3.56 0.140	Tin Plated Phos Bronze <sup>3</sup>	1217172-1	2, 4
D AMPLIVAR Direct Connect High Retention		0.76 - 2.13 1500 - 4200	2.79 0.110	1.90 - 3.20 .075 - .125	3.94 0.155	Tin Plated Phos Bronze <sup>3</sup>	1217174-1	2, 4
		2.00 - 4.30 4000 - 8500	3.56 0.140	2.30 - 4.30 .090 - .170	4.32 0.170	Tin Plated Phos Bronze <sup>3</sup>	1217173-1	2, 4

Notes: 1. Material shown is for reference only. May contain an equivalent copper alloy.  
 2. Receptacle must be contained in a housing listed on the previous page for proper performance.  
 3. Stand-alone receptacle can be used with or without a housing.  
 4. Connects up to 3 copper or aluminum magnet wires without removing the insulation.

Cluster Blocks

**MTM Crimpband Splices** This product line is not recommended for new designs, as the application machines are no longer manufactured.

**Product Facts**

- Made from a continuous coil of ribbon connector material
- Magnet wires MTM Crimpband splices have machine-piercing serrations designed for displacing magnet wire insulation.
- Available in brass, tin-plated brass, and copper-nickel alloy material
- Make parallel or pigtail connections on same machine
- 100% of Crimpband material is used in scrap free terminations
- Crimpband material coupled with appropriate toolsets accommodate specific CMA ranges
- Produced in TE equipment on your production floor
- Meets UL 486C crimp tensile requirements

**Applications**

- Motors windings and connections
- Coil connections
- Transformer windings and connections
- Lighting ballasts
- Power supplies

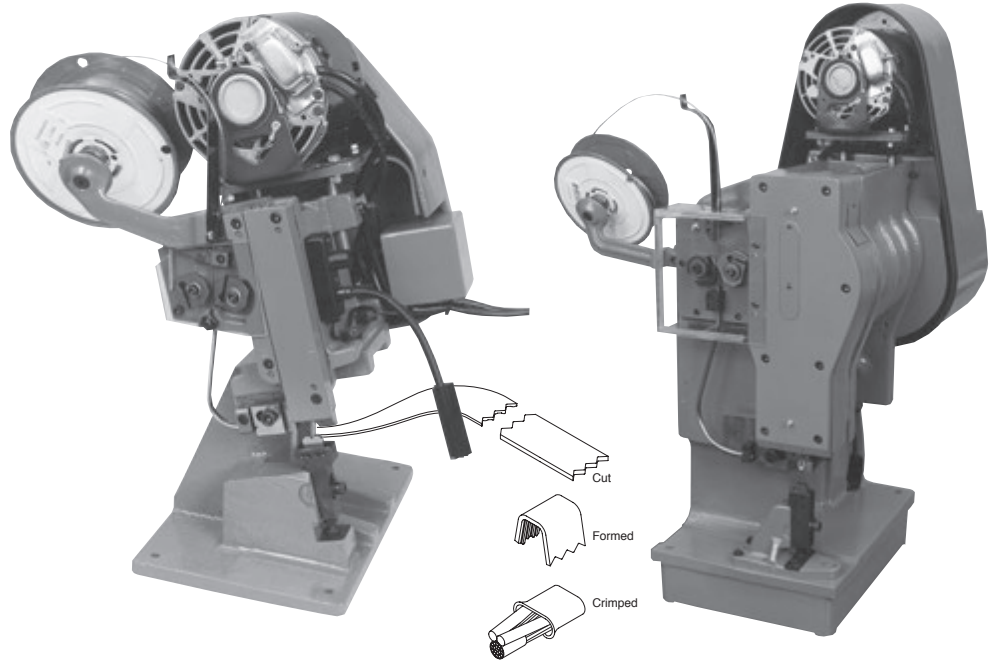

TE features the MTM Crimpband system that is comprised of two key features: the semi-automatic termination machine and a reel of MTM Crimpband material.

In a one-step crimping operation, the machine feeds, cuts, forms and crimps the material to provide a low-cost, high reliability crimp connection.

The MTM Crimpband splices are formed during the crimping process from

machined longitudinal grooved material that pierces magnet wire varnish film insulation during crimping.

MTM Crimpband splices are specifically designed to terminate magnet wire to itself or in combination with standard solid or stranded lead wire.

Three magnet wires maximum can be terminated together with stranded lead wire in one splice.

TE provides a wide range of toolset types and Crimpband splices to meet various production requirements.

Depending on your specific application, MTM Crimpband splices are available in 7, 9, 11 and 13 serration versions for terminations in the 400 to 13,000 CMA range.

When aluminum magnet wire is used, MTM Crimpband splices must be tin plated.

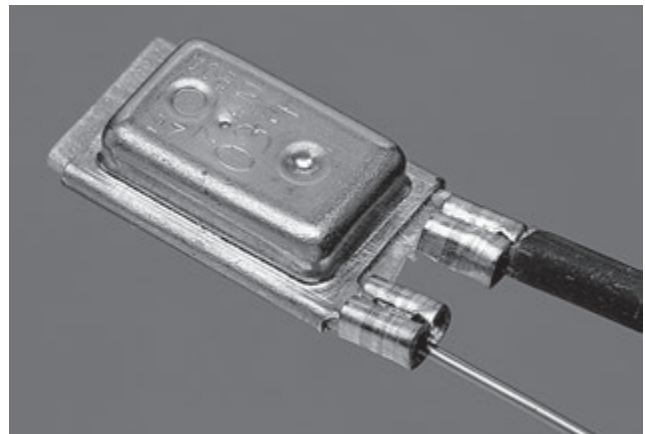
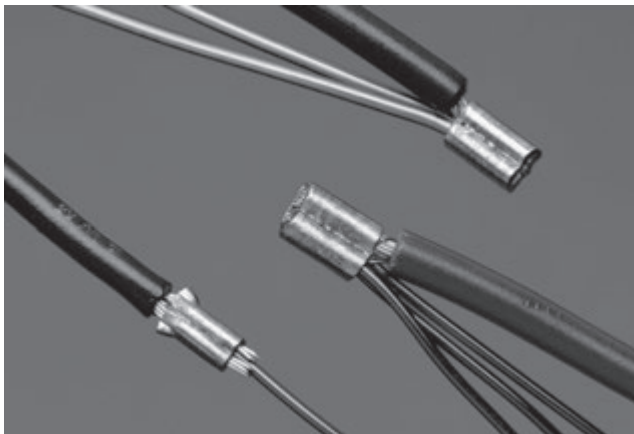

**MTM Crimpband Splices** (Continued) This product line is not recommended for new designs, as the application machines are no longer manufactured.

**MTM Crimpband Interconnection System**

**How the System Operates**

- ① **Feed (Magnet Wire Connector Material)**  
Machine feeds strip until the strip hits the wire stop.
- ② **Shear (Blank Length)**  
The strip is cut by the cutter block former bar insert tooling.
- ③ **Bend (Crimp Formed)**  
The former bar drives the cut strip over the anvil, bending the cut strip into an upside down "U".
- ④ **Wire (Placement)**  
In pigtail and parallel (Thru) splices magnet wires must be placed on top of the lead wire.
- ⑤ **Crimp (Crimp Formed)**  
The anvil retracts as the driver takes the formed strip down into the clincher.

**Notes:** To insure that the proper Crimpband splice is chosen, TE recommends the following:

1. Submit 10 samples of wire combinations and/or components to be crimped with any special requirements to your TE sales representative.
2. Pull-out force and/or millivolt drop tests will be performed to insure that the proper Crimpband material, toolset and crimp heights are recommended.
3. Tooling and testing will be documented on a Material & Tooling Sheet (M & T sheet).
4. Crimpband material quotes, tooling quotes and samples will be submitted to the customer.

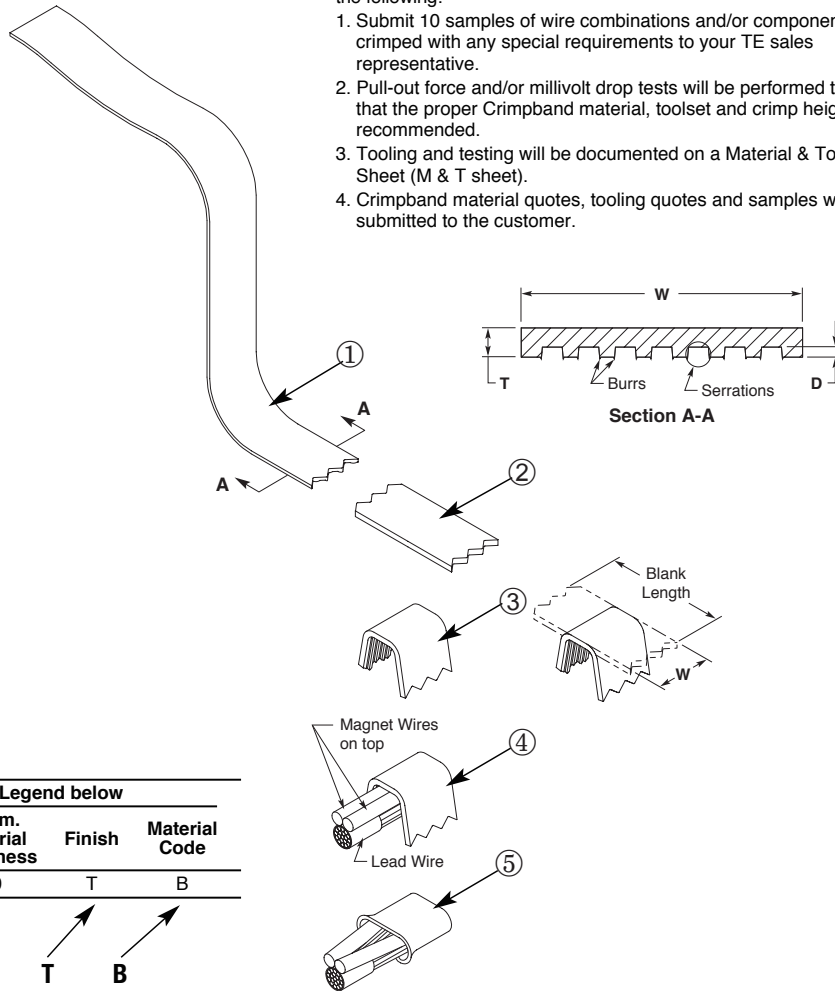

**Connector Specification Code**

Machine Basis	See Figure 1 and/or Legend below				
	B.L. Dim. Tooling Size	W Dim. Connector Width	T Dim. Material Thickness	Finish	Material Code
L	092	6R	20	T	B

**Splice No. Example:** L 092 6R 20 T B

**Legend**

Machine Basis		
L	P	G*
Leased	Purchase	General

\* Customer has their own Tooling

Tooling Size Code	Blank Length B/L (Nom.)
032	.167
032/036	.228
036	.224
045	.246
051	.267
061	.292
061/076	.324
076	.339
076/092	.361
092	.379
092/125	.413
125	.446
125/160	.485
125/165	.506
165	.546

**Note:** For B/L above, .546 consult TE for tooling size code.

Connector Width Code W		D Serration Depth
4R	5 Serrations	.138
6R	7 Serrations	.154
8R	9 Serrations	.194
10R	11 Serrations	.234

Material Thickness Code	T ±.002 Dim.	D Serration Depth
12	.012	.005
14	.014	.005
16	.016	.007
20	.020	.007
25	.025	.007

Material Code	Material/Finish
B	CDA 260 Brass
A	CDA 725 Copper/Nickel Alloy
TB	Pre-Tin over CDA 260 Brass

Wire Size AWG	UL486C Pull Out Force Requirements Underwriters Laboratory (lbs.)
26	3
24	5
22	8
20	10
18	10
16	15
14	25
12	35
10	40

Crimband



**MTM Crimpband Splices** (Continued) This product line is not recommended for new designs, as the application machines are no longer manufactured.

**11 Serrations**

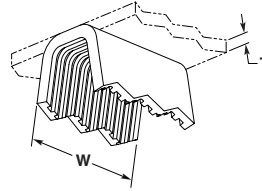

AWG/ mm <sup>2</sup>	Wire Range Solid Dia.	CMA Range	Stock Thk. (T)	Mat'l Width (W)	Material	Toolset	Part Number	Descriptive X-ref
14½-11½ 1.80-4.00	.059-.087 1.50-2.21	3500-7500	.025 0.64	.234 5.94	Brass	125/165	1601842-1	P125/ 16510R25B
14½-11½ 1.80-4.00	.059-.087 1.50-2.21	3500-7500	.025 0.64	.234 5.94	Tin Plated Brass	125/165	1601705-1	L125/ 16510R25TB
13½-10½ 2.54-4.50	.071-.097 1.70-2.46	4500-9500	.025 0.64	.234 5.94	Brass	165/200	1601847-1	P165/ 20010R25B
13½-10½ 2.54-4.50	.071-.097 1.70-2.46	4500-9500	.025 0.64	.234 5.94	Tin Plated Brass	165/200	1601848-1	P165/ 20010R25TB

**9 Serrations**

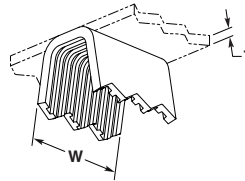

AWG/ mm <sup>2</sup>	Wire Range Solid Dia.	CMA Range	Stock Thk. (T)	Mat'l Width (W)	Material	Toolset	Part Number	Descriptive X-ref
24-20 0.20-0.50	.020-.033 0.51-0.84	400-1100	.016 0.41	.194 4.93	Tin Plated Brass	032/036	1601794-1†	P032/ 0368R16TB
20½-16 0.45-1.30	.030-.051 0.76-1.29	900-2600	.018 0.46	.194 4.93	Tin Plated Brass	061	1601607-1†	L0618R16TB
20½-16 0.45-1.30	.030-.051 0.76-1.29	900-2600	.018 0.46	.194 4.93	Brass	061	1601608-1	L0618R20B
20½-16 0.45-1.30	.030-.051 0.76-1.29	900-2600	.018 0.46	.194 4.93	Tin Plated Brass	061	1601814-1†	P0618R20TB
18-14 0.80-2.00	.040-.063 1.02-1.60	1600-4000	.016 0.41	.194 4.93	Tin Plated Brass	076	1601824-1	P0768R16TB
18-14 0.80-2.00	.040-.063 1.02-1.60	1600-4000	.020 0.51	.194 4.93	Tin Plated Brass	076	1601857-1	PO768R20TB
18-14 0.80-2.00	.040-.063 1.02-1.60	1800-4600	.020 0.51	.194 4.93	Brass	076/092	1601823-1	P076/ 0928R20B
18-14 0.80-2.00	.040-.063 1.02-1.60	1800-4600	.020 0.51	.194 4.93	Tin Plated Brass	076/092	1601639-1	L076/ 0928R20TB
16-12 1.30-3.46	.051-.078 1.29-1.98	2600-6100	.020 0.51	.194 4.93	Brass	092/125	1601833-1	P092/ 1258R20B
16-12 1.30-3.46	.051-.078 1.29-1.98	2600-6100	.020 0.51	.194 4.93	Tin Plated Brass	092/125	1601677-1	L092/ 1258R20TB
16-12 1.30-3.46	.051-.078 1.29-1.98	2600-6100	.025 0.64	.194 4.93	Brass	092/125	1601678-1†	L092/ 1258R25B
16-12 1.30-3.46	.051-.078 1.29-1.98	2600-6100	.025 0.64	.194 4.93	Tin Plated Brass	092/125	1601835-1†	P092/ 1258R25TB
15½-12 1.54-3.46	.055-.082 1.40-2.10	3000-6750	.016 0.41	.194 4.93	Brass	125	1601717-1†	L1258R16B
15½-12 1.54-3.46	.055-.082 1.40-2.10	3000-6750	.016 0.41	.194 4.93	Tin Plated Brass	125	1601718-1	L1258R16TB
15½-12 1.54-3.46	.055-.082 1.40-2.10	3000-6750	.020 0.51	.194 4.93	Brass	125	1601846-1	P1258R20B
15½-12 1.54-3.46	.055-.082 1.40-2.10	3000-6750	.025 0.64	.194 4.93	Brass	125	1601719-1	L1258R25B
14½-11½ 1.80-4.00	.059-.087 1.50-2.21	3500-7500	.025 0.64	.194 4.93	Brass	125/165	1601706-1	L125/ 1658R25B
14½-11½ 1.80-4.00	.059-.087 1.50-2.21	3500-7500	.025 0.64	.194 4.93	Tin Plated Brass	125/165	1601707-1	L125/ 1658R25TB
14-11 2.00-4.20	.063-.092 1.60-2.34	4000-8500	.025 0.64	.194 4.93	Tin Plated Brass	165	1601750-1†	L1658R25TB
11½-9 4.00-6.50	.084-.114 2.13-2.90	7000-13000	.025 0.64	.194 4.93	Tin Plated Brass	200/202	1601761-1	L200/ 2028R25TB

† These part numbers are available upon special request; contact TE engineering for details.

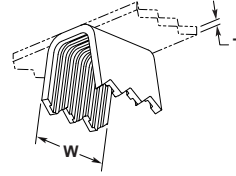
**MTM Crimpband Splices** (Continued) This product line is not recommended for new designs, as the application machines are no longer manufactured.
**7 Serrations**

AWG/ mm <sup>2</sup>	Wire Range Solid Dia.	CMA Range	Stock Thk. (T)	Mat'l Width (W)	Material	Toolset	Part Number	Descriptive X-ref
27½-21 0.09-0.40	.013-.028 0.33-0.71	170-800	.012 0.30	.154 3.91	Brass	032	1601800-1	P0326R12BUF <sup>1</sup>
24-20 0.20-0.50	.020-.033 0.51-0.84	400-1100	.012 0.30	.154 3.91	Brass	032/036	1601539-1	L032/ 0366R12B
24-20 0.20-0.50	.020-.033 0.51-0.84	400-1100	.012 0.30	.154 3.91	Cu Ni	032/036	1601538-1	L032/ 0366R12AUF <sup>1</sup>
24-20 0.20-0.50	.020-.033 0.51-0.84	400-1100	.016 0.41	.154 3.91	Brass	032/036	1601540-1	L032/ 0366R16B
24-20 0.20-0.50	.020-.033 0.51-0.84	400-1100	.016 0.41	.154 3.91	Tin Plated Brass	032/036	1601793-1	P032/ 0366R16TB
22-19 0.38-0.60	.024-.036 0.70-0.91	600-1300	.016 0.41	.154 3.91	Brass	045	1601559-1	L0456R16B
22-19 0.38-0.60	.024-.036 0.70-0.91	600-1300	.020 0.51	.154 3.91	Brass	045	1601560-1†	L0456R20B
20½-16 0.45-1.30	.030-.051 0.76-1.29	900-2600	.016 0.41	.154 3.91	Brass	061	1601604-1	L0616R16B
20½-16 0.45-1.30	.030-.051 0.76-1.29	900-2600	.016 0.41	.154 3.91	Tin Plated Brass	061	1601606-1	L0616R16TB
18-14 0.80-2.00	.040-.063 1.02-1.60	1600-4000	.016 0.41	.154 3.91	Brass	076	1601644-1	L0766R16B
18-14 0.80-2.00	.040-.063 1.02-1.60	1600-4000	.016 0.41	.154 3.91	Tin Plated Brass	076	1601646-1†	L0766R16TB
18-14 0.80-2.00	.040-.063 1.02-1.60	1600-4000	.020 0.51	.154 3.91	Brass	076	1601647-1†	L0766R20B
17½-13½ 0.95-2.54	.042-.068 1.07-1.80	1800-4600	.016 0.41	.154 3.91	Brass	076/092	1601637-1	L076/ 0926R16BX
16½-13 1.10-2.60	.047-.072 1.19-1.83	2200-5200	.016 0.41	.154 3.91	Tin Plated Brass	092	1601683-1	L0926R16TB
16-12 1.30-3.46	.051-.078 1.29-1.98	2600-6100	.016 0.41	.154 3.91	Tin Plated Brass	092/125	1601675-1	L092/ 1256R16TB
16-12 1.30-3.46	.051-.078 1.29-1.98	2600-6100	.020 0.51	.154 3.91	Brass	092/125	1601832-1	P092/ 1256R20B
15½-12 1.54-3.46	.055-.082 1.40-2.10	3000-6750	.012 0.30	.154 3.91	Brass	125	1601844-1	P1256R12B
15½-12 1.54-3.46	.055-.082 1.40-2.10	3000-6750	.016 0.41	.154 3.91	Brass	125	1601845-1	P1256R16B
15½-12 1.54-3.46	.055-.082 1.40-2.10	3000-6750	.016 0.41	.154 3.91	Tin Plated Brass	125	1601716-1†	L1256R16TB

<sup>1</sup> UF designates Ultra-Fine serrations which are recommended for applications using wire size 28 AWG [0.32 mm] or smaller.

† These part numbers are available upon special request; contact TE engineering for details.

**RTM Crimpband Splices**

**This product line is not recommended for new designs, as the application machines are no longer manufactured.**

**Product Facts**

- Made from a continuous coil of "Ribbon Connector" material
- RTM Crimpband have grooved serrations for improved axial retention.
- Available in brass, tin-plate d brass and copper-nickel alloy (CA725) materia I
- Make parallel or pigtail connections on same machine
- Used for electrical and non-electrical connections.
- 100% of RTM Crimpband material is used in scrap free terminations
- Crimpband material coupled with appropriate toolsets accommodate specific CMA ranges
- Produced in TE equipment on your production floor
- Meets UL 486C crimp tensile requirements

**Applications**

- Stranded and solid wire-to-wire connections
- Light bulb LED assembly
- Switch lead assembly
- Resistor lead assembly
- Printed circuit board lead assembly
- Flex-film lead assembly
- Glass reed switch lead assembly

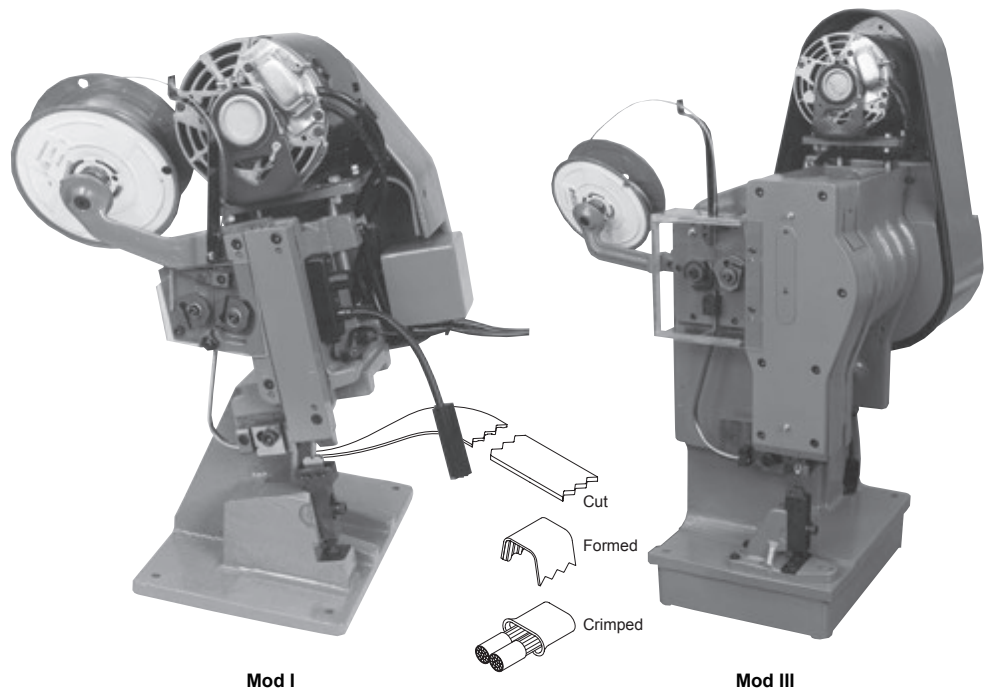

TE features the RTM Crimpband system that is comprised of two key features: the semi-automatic termination machine and a reel of RTM Crimpband material.

In a one-step crimping operation, the machine feeds, cuts, forms and crimps the material to provide a low-cost, high reliability crimp connection.

The RTM Crimpband splices are formed during the crimping process from

milled longitudinal groove material that produce rolled, rounded serrations.

They are designed to terminate pre-stripped stranded and solid wire conductors together as well as wire conductors to switch tabs, resistors, printed circuit board, flex circuit and light bulb LED and glass reed switch assemblies, etc.

The flexibility of the RTM Crimpband system provides opportunity for use in custom applications for

either electrical and / or mechanical connections.

TE provides a wide range of toolset types and crimpband splices to meet various production requirements.

Depending on your specific application, RTM Crimpband splices are available in 3, 6, 7, 8, 9, 10 14 and 20 ridge serration versions for terminations in the 170 to 13,000 CMA range.

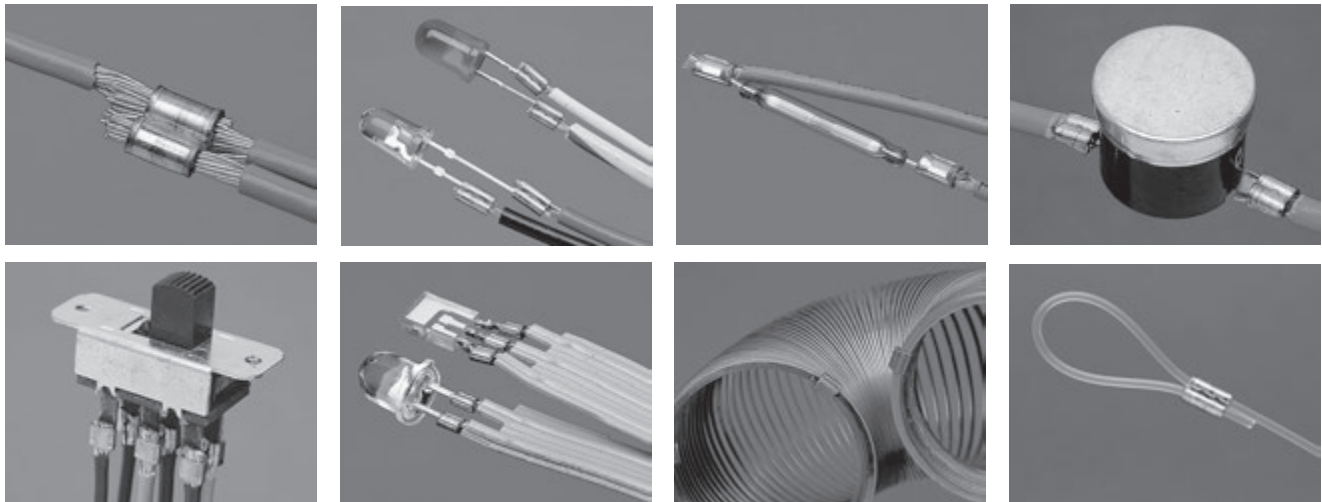

**RTM Crimpband Splices (Continued)** This product line is not recommended for new designs, as the application machines are no longer manufactured.

**RTM Crimpband Interconnection System**

**How the System Operates**

- ① **Feed (Ribbon Connector Material)**  
Machine feeds strip until the strip hits the wire stop.
- ② **Shear (Blank Length)**  
The strip is cut by the cutter block former bar insert tooling.
- ③ **Bend (Crimp Formed)**  
The former bar drives the cut strip over the anvil, bending the cut strip into an upside down "U".
- ④ **Wire (Placement)**  
Pigtails and parallel (Thru) splice terminations are made on the same machine.
- ⑤ **Crimp (Crimp Formed)**  
The anvil retracts as the driver takes the formed strip down into the clincher.

**Notes:** To insure that the proper Crimpband splice is chosen, TE recommends the following:

1. Submit 10 samples of wire combinations and/or components to be crimped with any special requirements to your TE sales representative.
2. Pull-out force and/or millivolt drop tests will be performed to insure that the proper Crimpband material, toolset and crimp heights are recommended.
3. Tooling and testing will be documented on a Material & Tooling Sheet (M & T sheet).
4. Crimpband material quotes, tooling quotes and samples will be submitted to the customer.

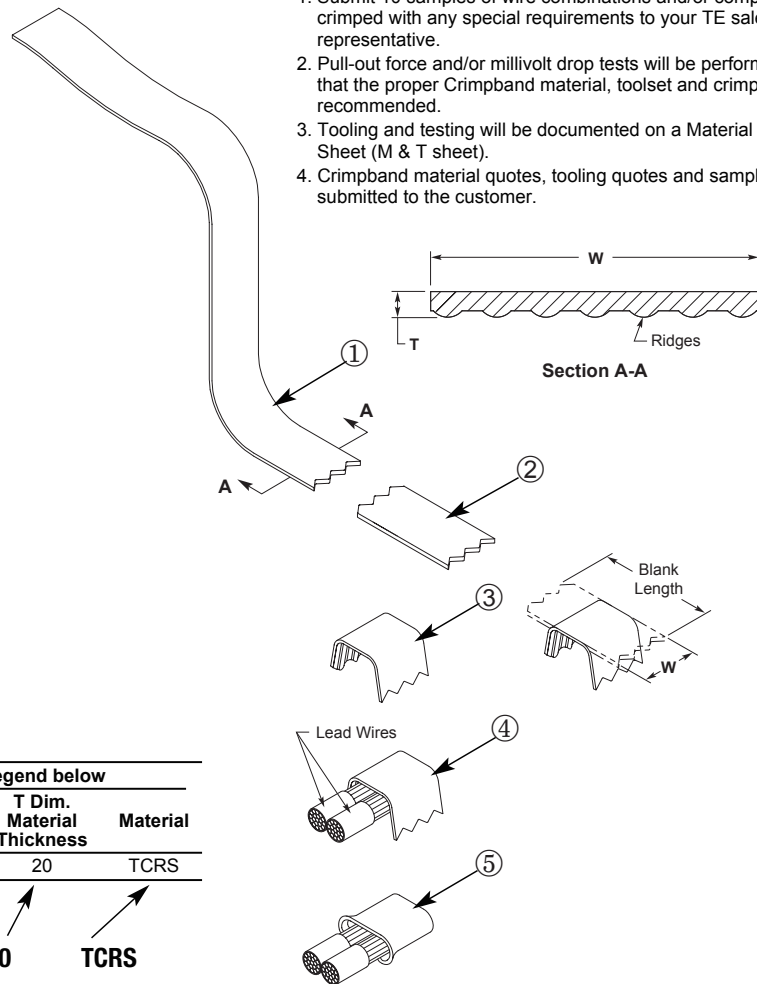

**Connector Specification Code**

See Figure 1 and/or Legend below

Machine Basis	B.L. Dim. Tooling Size	W Dim. Connector Width	T Dim. Material Thickness	Material
L	092	F	20	TCRS

Splice No. Example: **L 092 F 20 TCRS**

**Legend**

Machine Basis	
L	P
Leased	Purchase

Tooling Size Code	Blank Length B/L (Nom.)
032	.167
032/036	.228
036	.224
045	.246
051	.267
061	.292
061/076	.324
076	.339
076/092	.361
092	.379
092/125	.413
125	.446
125/160	.485
125/165	.506
165	.546

Connector Width Code	W Dim.	N No. of Ridges
B	.076	3
C	.138	6
D	.154	7
E	.185	8
F	.216	9
G	.234	10
H	.247	10
L	.086	3
M	.330	14
N	.500	20
P	.114	5

Material Thickness Code	T±.002 Dim.
12	.012
16	.016
18	.018
20	.020
22	.022
24	.024
25	.025

Material Code	Material/Finish
B	CDA 260 Brass
A	CDA 725 Copper/Nickel Alloy
TB	Pre-Tin over CDA 260 Brass
TCRS	1010 Cold Rolled Steel, Tin Plated
SS	301 or 302 Stainless Steel
ST	Stainless Steel, Tin Plated

Wire Size AWG	UL486C Pull Out Force Requirements Underwriters Laboratory (lbs.)
26	3
24	5
22	8
20	10
18	10
16	15
14	25
12	35
10	40

**Note:** For B/L above, .546 consult factory for tooling size code

**RTM Crimpband Splices** (Continued)

**This product line is not recommended for new designs, as the application machines are no longer manufactured.**

**20 Ridges**

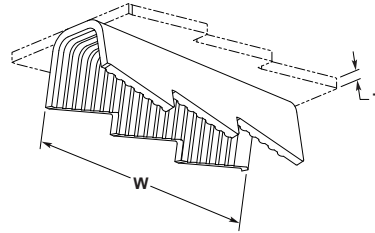

AWG/ mm <sup>2</sup>	Wire Range Solid Dia.	CMA Range	Stock Thk. (T)	Mat'l Width (W)	Material	Toolset	Part Number	Descriptive X-ref
11½-9 4.00-6.50	.084-.114 2.13-2.90	7000-13000	.020 0.51	.500 12.70	Tin Plated Brass	200/202	1601771-1	L200/202N20TB

**14 Ridges**

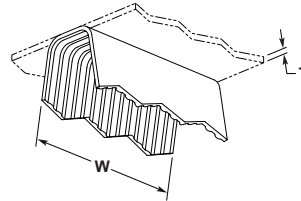

AWG/ mm <sup>2</sup>	Wire Range Solid Dia.	CMA Range	Stock Thk. (T)	Mat'l Width (W)	Material	Toolset	Part Number	Descriptive X-ref
22-19 0.38-0.60	.024-.036 0.61-0.91	600-1300	.012 0.30	.330 8.38	Cu Ni	045	1601577-1†	L045M12A
22-19 0.38-0.60	.024-.036 0.61-0.91	600-1300	.012 0.30	.330 8.38	Brass	045	1601578-1	L045M12B

† These part numbers are available upon special request; contact TE engineering for details.

**10 Ridges**

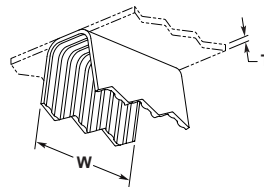

AWG/ mm <sup>2</sup>	Wire Range Solid Dia.	CMA Range	Stock Thk. (T)	Mat'l Width (W)	Material	Toolset	Part Number	Descriptive X-ref
22-19 0.38-0.60	.024-.036 0.61-0.91	600-1300	.012 0.30	.234 5.94	Brass	045	1601575-1	L045G12B
21-18½ 0.40-0.75	.028-.039 0.71-0.99	800-1500	.016 0.41	.234 5.94	Cu Ni	051	1601593-1†	L051G16A
20½-16 0.45-1.30	.030-.051 0.76-1.29	900-2600	.012 0.30	.234 5.94	Brass	061	1601632-1†	L061G12B
20½-16 0.45-1.30	.030-.051 0.76-1.29	900-2600	.020 0.51	.234 5.94	Brass	061	1601633-1	L061G20B
11½-9 4.00-6.50	.084-.114 2.13-2.90	7000-13000	.020 0.51	.234 5.94	Brass	200/202	1601853-1	P200/ 202G20B
11½-9 4.00-6.50	.084-.114 2.13-2.90	7000-13000	.025 0.64	.234 5.94	Brass	200/202	1601769-1	L200/ 202G25BX

† These part numbers are available upon special request; contact TE engineering for details.

**RTM Crimpband Splices** (Continued) This product line is not recommended for new designs, as the application machines are no longer manufactured.

**9 Ridges**

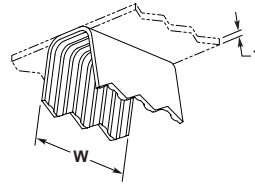

AWG/ mm <sup>2</sup>	Wire Range Solid Dia.	CMA Range	Stock Thk. (T)	Mat'l Width (W)	Material	Toolset	Part Number	Descriptive X-ref
22-19 0.38-0.60	<b>.024-.036</b> 0.61-0.91	600-1300	<b>.012</b> 0.30	<b>.216</b> 5.49	Stainless Steel	045	1601807-1	P045F12SS
20½-16 0.45-1.30	<b>.030-.051</b> 0.76-1.29	900-2600	<b>.012</b> 0.30	<b>.216</b> 5.49	Stainless Steel	061	1601520-1	G061F12SS

**8 Ridges**

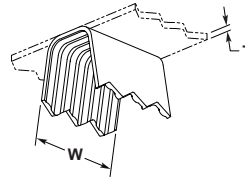

AWG/ mm <sup>2</sup>	Wire Range Solid Dia.	CMA Range	Stock Thk. (T)	Mat'l Width (W)	Material	Toolset	Part Number	Descriptive X-ref
24-20 0.20-0.50	<b>.020-.033</b> 0.51-0.84	400-1100	<b>.012</b> 0.30	<b>.185</b> 4.70	Cu Ni	032/036	1601553-1	L032/ 036E12A
18-14 0.80-2.00	<b>.040-.063</b> 1.02-1.60	1600-4000	<b>.018</b> 0.46	<b>.185</b> 4.70	Tin Plated CRS	076	1601669-1	L076E18TCRS
11½-9 4.00-6.50	<b>.084-.114</b> 2.13-2.90	7000-13000	<b>.024</b> 0.61	<b>.185</b> 4.70	Brass	200/202	1601768-1	L200/ 202E24B

**7 Ridges**

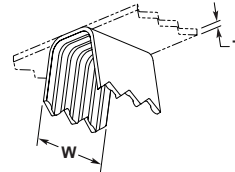

AWG/ mm <sup>2</sup>	Wire Range Solid Dia.	CMA Range	Stock Thk. (T)	Mat'l Width (W)	Material	Toolset	Part Number	Descriptive X-ref
24-20 0.20-0.50	<b>.020-.033</b> 0.51-0.84	400-1100	<b>.012</b> 0.30	<b>.154</b> 3.91	Brass	032/036	1601550-1	L032/ 036D12B
24-20 0.20-0.50	<b>.020-.033</b> 0.51-0.84	400-1100	<b>.016</b> 0.41	<b>.154</b> 3.91	Cu Ni	032/036	1601551-1	L032/ 036D16A
24-20 0.20-0.50	<b>.020-.033</b> 0.51-0.84	400-1100	<b>.016</b> 0.41	<b>.154</b> 3.91	Brass	032/036	1601797-1	P032/ 036D16B
24-20 0.20-0.50	<b>.020-.033</b> 0.51-0.84	400-1100	<b>.016</b> 0.41	<b>.154</b> 3.91	Tin Plated Brass	032/036	1601798-1	P032/ 036D16TB
22-19 0.38-0.60	<b>.024-.036</b> 0.61-0.91	600-1300	<b>.012</b> 0.30	<b>.154</b> 3.91	Brass	045	1601572-1	L045D12B
22-19 0.38-0.60	<b>.024-.036</b> 0.61-0.91	600-1300	<b>.016</b> 0.41	<b>.154</b> 3.91	Cu Ni	045	1601573-1	L045D16A

Crimband



**RTM Crimpband Splices** (Continued)

This product line is not recommended for new designs, as the application machines are no longer manufactured.

**7 Ridges** (Continued)

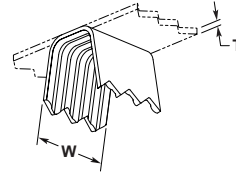

AWG/ mm <sup>2</sup>	Wire Range Solid Dia.	CMA Range	Stock Thk. (T)	Mat'l Width (W)	Material	Toolset	Part Number	Descriptive X-ref
22-19 0.38-0.60	.024-.036 0.61-0.91	600-1300	.016 0.41	.154 3.91	Brass	045	1601507-1†	G045D16B
21-18½ 0.40-0.75	.028-.039 0.71-0.99	800-1500	.012 0.30	.154 3.91	Brass	051	1601587-1	L051D12B
21-18½ 0.40-0.75	.028-.039 0.71-0.99	800-1500	.016 0.41	.154 3.91	Brass	051	1601588-1	L051D16B
21-18½ 0.40-0.75	.028-.039 0.71-0.99	800-1500	.020 0.51	.154 3.91	Nickel Plated Steel	051	1601591-1	L051D20NPS
21-18½ 0.40-0.75	.028-.039 0.71-0.99	800-1500	.020 0.51	.154 3.91	Tin Plated CRS	051	1601811-1†	P051D20TCRS
20½-16 0.45-1.30	.030-.051 0.76-1.29	900-2600	.012 0.30	.154 3.91	Cu Ni	061	1601818-1†	P061D12A
20½-16 0.45-1.30	.030-.051 0.76-1.29	900-2600	.012 0.30	.154 3.91	Brass	061	1601620-1†	L061D12B
20½-16 0.45-1.30	.030-.051 0.76-1.29	900-2600	.012 0.30	.154 3.91	Tin Plated Brass	061	1601514-1†	G061D12TB
20½-16 0.45-1.30	.030-.051 0.76-1.29	900-2600	.016 0.41	.154 3.91	Cu Ni	061	1601819-1	P061D16A
20½-16 0.45-1.30	.030-.051 0.76-1.29	900-2600	.016 0.41	.154 3.91	Brass	061	1601820-1	P061D16B
20½-16 0.45-1.30	.030-.051 0.76-1.29	900-2600	.016 0.41	.154 3.91	Tin Plated Brass	061	1601623-1	L061D16TB
20½-16 0.45-1.30	.030-.051 0.76-1.29	900-2600	.018 0.46	.154 3.91	Brass	061	1601625-1	L061D18B
20½-16 0.45-1.30	.030-.051 0.76-1.29	900-2600	.018 0.46	.154 3.91	Tin Plated Brass	061	1601628-1	L061D18TB
20½-16 0.45-1.30	.030-.051 0.76-1.29	900-2600	.020 0.51	.154 3.91	Cu Ni	061	1601629-1	L061D20A
20½-16 0.45-1.30	.030-.051 0.76-1.29	900-2600	.020 0.51	.154 3.91	Brass	061	1601630-1	L061D20B
20½-16 0.45-1.30	.030-.051 0.76-1.29	900-2600	.020 0.51	.154 3.91	Tin Plated Brass	061	1601631-1	L061D20TBX
20-15 0.60-1.60	.033-.057 0.84-1.45	1100-3200	.016 0.41	.154 3.91	Brass	061/076	1601601-1	L061/076D16B
19½-14½ 0.60-1.80	.035-.061 0.89-1.54	1200-3700	.016 0.41	.154 3.91	Brass	061/092	1601603-1	L061/092D16B
18-14 0.80-2.00	.040-.063 1.02-1.60	1600-4000	.012 0.30	.154 3.91	Cu Ni	076	1601828-1	P076D12A
18-14 0.80-2.00	.040-.063 1.02-1.60	1600-4000	.012 0.30	.154 3.91	Brass	076	1601655-1†	L076D12B
18-14 0.80-2.00	.040-.063 1.02-1.60	1600-4000	.016 0.41	.154 3.91	Cu Ni	076	1601656-1	L076D16A
18-14 0.80-2.00	.040-.063 1.02-1.60	1600-4000	.016 0.41	.154 3.91	Brass	076	1601829-1	P076D16B
18-14 0.80-2.00	.040-.063 1.02-1.60	1600-4000	.016 0.41	.154 3.91	Tin Plated Brass	076	1601658-1	L076D16TB
18-14 0.80-2.00	.040-.063 1.02-1.60	1600-4000	.018 0.46	.154 3.91	Cu Ni	076	1601660-1	L076D18AX
18-14 0.80-2.00	.040-.063 1.02-1.60	1600-4000	.018 0.46	.154 3.91	Brass	076	1601661-1	L076D18B
18-14 0.80-2.00	.040-.063 1.02-1.60	1600-4000	.018 0.46	.154 3.91	Tin Plated Brass	076	1601664-1	L076D18TB
18-14 0.80-2.00	.040-.063 1.02-1.60	1600-4000	.020 0.51	.154 3.91	Brass	076	1601665-1	L076D20B
18-14 0.80-2.00	.040-.063 1.02-1.60	1600-4000	.020 0.51	.154 3.91		076	1601667-1	L076D20TCRS
18-14 0.80-2.00	.040-.063 1.02-1.60	1600-4000	.024 0.61	.154 3.91	Brass	076	1601668-1	L076D24B

† These part numbers are available upon special request; contact TE engineering for details.

**RTM Crimpband Splices** (Continued) This product line is not recommended for new designs, as the application machines are no longer manufactured.

**7 Ridges** (Continued)

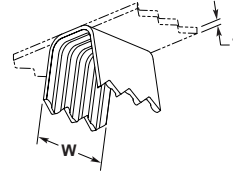

AWG/ mm <sup>2</sup>	Wire Range Solid Dia.	CMA Range	Stock Thk. (T)	Mat'l Width (W)	Material	Toolset	Part Number	Descriptive X-ref
17½-13 0.95-2.54	.042-.068 1.07-1.80	1800-4600	.016 0.41	.154 3.91	Brass	076/092	1601642-1	L076/ 092D16BX
16½-13 1.10-2.60	.047-.072 1.19-1.83	2200-5200	.016 0.41	.154 3.91	Cu Ni	092	1601689-1	L092D16ASP
16½-13 1.10-2.60	.047-.072 1.19-1.83	2200-5200	.016 0.41	.154 3.91	Brass	092	1601691-1	L092D16B
16½-13 1.10-2.60	.047-.072 1.19-1.83	2200-5200	.016 0.41	.154 3.91	Tin Plated Brass	092	1601693-1	L092D16TB
16½-13 1.10-2.60	.047-.072 1.19-1.83	2200-5200	.018 0.46	.154 3.91	Cu Ni	092	1601694-1	L092D18A
16½-13 1.10-2.60	.047-.072 1.19-1.83	2200-5200	.018 0.46	.154 3.91	Brass	092	1601695-1	L092D18B
16½-13 1.10-2.60	.047-.072 1.19-1.83	2200-5200	.018 0.46	.154 3.91	Tin Plated Brass	092	1601841-1	P092D18TB
16½-13 1.10-2.60	.047-.072 1.19-1.83	2200-5200	.020 0.51	.154 3.91	Brass	092	1601528-1†	G092D20B
16-12 1.30-3.46	.051-.078 1.29-1.98	2600-6100	.020 0.51	.154 3.91	Cu Ni	092/125	1601680-1	L092/ 125D20A
16-12 1.30-3.46	.051-.078 1.29-1.98	2600-6100	.020 0.51	.154 3.91	Brass	092/125	1601681-1	L092/ 125D20B
16-12 1.30-3.46	.051-.078 1.29-1.98	2600-6100	.020 0.51	.154 3.91	Tin Plated CRS	092/125	1601682-1	092/ 125D20TCRS
15½-12 1.54-3.46	.055-.082 1.40-2.10	3000-6750	.016 0.41	.154 3.91	Brass	125	1601529-1	G125D16B
15½-12 1.54-3.46	.055-.082 1.40-2.10	3000-6750	.018 0.46	.154 3.91	Cu Ni	125	1601531-1	G125D18A
15½-12 1.54-3.46	.055-.082 1.40-2.10	3000-6750	.018 0.46	.154 3.91	Brass	125	1601726-1	L125D18B
15½-12 1.54-3.46	.055-.082 1.40-2.10	3000-6750	.018 0.46	.154 3.91	Tin Plated Brass	125	1601729-1	L125D18TBX
15½-12 1.54-3.46	.055-.082 1.40-2.10	3000-6750	.020 0.51	.154 3.91	Brass	125	1601730-1	L125D20B
15½-12 1.54-3.46	.055-.082 1.40-2.10	3000-6750	.020 0.51	.154 3.91	Tin Plated Brass	125	1601731-1	L125D20TB
15½-12 1.54-3.46	.055-.082 1.40-2.10	3000-6750	.020 0.51	.154 3.91		125	1601733-1	L125D20TCRS
14½-11½ 1.80-4.00	.059-.087 1.50-2.21	3500-7500	.018 0.46	.154 3.91	Tin Plated Brass	125/165	1601709-1	L125/ 165D18TB
14½-11½ 1.80-4.00	.059-.087 1.50-2.21	3500-7500	.020 0.51	.154 3.91	Cu Ni	125/165	1601710-1	L125/ 165D20A
14½-11½ 1.80-4.00	.059-.087 1.50-2.21	3500-7500	.020 0.51	.154 3.91	Brass	125/165	1601711-1	L125/ 165D20B
14½-11½ 1.80-4.00	.059-.087 1.50-2.21	3500-7500	.020 0.51	.154 3.91	Tin Plated Brass	125/165	1601712-1	L125/ 165D20TB
14-11 2.00-4.20	.063-.092 1.60-2.34	4000-8500	.020 0.51	.154 3.91	Cu Ni	165	1601754-1†	L165D20A
14-11 2.00-4.20	.063-.092 1.60-2.34	4000-8500	.020 0.51	.154 3.91	Brass	165	1601755-1	L165D20B
13½-10½ 2.54-4.50	.071-.097 1.70-2.46	4500-9500	.020 0.51	.154 3.91	Brass	165/200	1601532-1	G165/ 200D20B
11½-9 4.00-6.50	.084-.114 2.13-2.90	7000-13000	.016 0.41	.154 3.91	Brass	200/202	1601764-1	L200/ 202D16B
11½-9 4.00-6.50	.084-.114 2.13-2.90	7000-13000	.020 0.51	.154 3.91	Cu Ni	200/202	1601765-1	L200/ 202D20A
11½-9 4.00-6.50	.084-.114 2.13-2.90	7000-13000	.020 0.51	.154 3.91	Brass	200/202	1601852-1	P200/ 202D20B
11½-9 4.00-6.50	.084-.114 2.13-2.90	7000-13000	.020 0.51	.154 3.91	Tin Plated Brass	200/202	1601766-1	L200/ 202D20TB

† These part numbers are available upon special request; contact TE engineering for details.

Crimband

**RTM Crimpband Splices** (Continued) This product line is not recommended for new designs, as the application machines are no longer manufactured.

**6 Ridges**

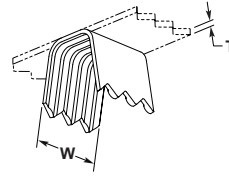

AWG/ mm <sup>2</sup>	Wire Range Solid Dia.	CMA Range	Stock Thk. (T)	Mat'l Width (W)	Material	Toolset	Part Number	Descriptive X-ref
24-20 0.20-0.50	<b>.020-.033</b> 0.51-0.84	400-1100	<b>.012</b> 0.30	<b>.138</b> 3.51	Tin Plated Brass	032/036	1601548-1	L032/ 036C12TB
24-20 0.20-0.50	<b>.020-.033</b> 0.51-0.84	400-1100	<b>.016</b> 0.41	<b>.138</b> 3.51	Brass	032/036	1601549-1	L032/ 036C16B
22-19 0.38-0.60	<b>.024-.036</b> 0.61-0.91	600-1300	<b>.012</b> 0.30	<b>.138</b> 3.51	Brass	045	1601566-1	L045C12B
22-19 0.38-0.60	<b>.024-.036</b> 0.61-0.91	600-1300	<b>.016</b> 0.41	<b>.138</b> 3.51	Cu Ni	045	1601569-1	L045C16A
22-19 0.38-0.60	<b>.024-.036</b> 0.61-0.91	600-1300	<b>.016</b> 0.41	<b>.138</b> 3.51	Brass	045	1601571-1	L045C16B
21-18½ 0.40-0.75	<b>.028-.039</b> 0.71-0.99	800-1500	<b>.012</b> 0.30	<b>.138</b> 3.51	Brass	051	1601808-1†	P051C12B
21-18½ 0.40-0.75	<b>.028-.039</b> 0.71-0.99	800-1500	<b>.016</b> 0.41	<b>.138</b> 3.51	Cu Ni	051	1601809-1	P051C16A
21-18½ 0.40-0.75	<b>.028-.039</b> 0.71-0.99	800-1500	<b>.016</b> 0.41	<b>.138</b> 3.51	Brass	051	1601810-1	P051C16B
21-18½ 0.40-0.75	<b>.028-.039</b> 0.71-0.99	800-1500	<b>.018</b> 0.46	<b>.138</b> 3.51	Brass	051	1601586-1†	L051C18B
20½-16 0.45-1.30	<b>.030-.051</b> 0.76-1.29	900-2600	<b>.016</b> 0.41	<b>.138</b> 3.51	Cu Ni	061	1601614-1	L061C16A
20½-16 0.45-1.30	<b>.030-.051</b> 0.76-1.29	900-2600	<b>.016</b> 0.41	<b>.138</b> 3.51	Brass	061	1601511-1	G061C16B
20½-16 0.45-1.30	<b>.030-.051</b> 0.76-1.29	900-2600	<b>.016</b> 0.41	<b>.138</b> 3.51	Tin Plated Brass	061	1601617-1	L061C16TB
20½-16 0.45-1.30	<b>.030-.051</b> 0.76-1.29	900-2600	<b>.018</b> 0.46	<b>.138</b> 3.51	Cu Ni	061	1601618-1	L061C18AX
20½-16 0.45-1.30	<b>.030-.051</b> 0.76-1.29	900-2600	<b>.018</b> 0.46	<b>.138</b> 3.51	Brass	061	1601619-1	L061C18B
20½-16 0.45-1.30	<b>.030-.051</b> 0.76-1.29	900-2600	<b>.020</b> 0.51	<b>.138</b> 3.51	Brass	061	1601513-1†	G061C20B
20-15 0.60-1.60	<b>.033-.057</b> 0.84-1.45	1100-3200	<b>.016</b> 0.41	<b>.138</b> 3.51	Brass	061/076	1601597-1	L061/ 076C16B
20-15 0.60-1.60	<b>.033-.057</b> 0.84-1.45	1100-3200	<b>.016</b> 0.41	<b>.138</b> 3.51	Tin Plated Brass	061/076	1601599-1	L061/ 076C16TB
20-15 0.60-1.60	<b>.033-.057</b> 0.84-1.45	1100-3200	<b>.018</b> 0.46	<b>.138</b> 3.51	Brass	061/076	1601600-1†	L061/ 076C18B
18-14 0.80-2.00	<b>.040-.063</b> 1.02-1.60	1600-4000	<b>.016</b> 0.41	<b>.138</b> 3.51	Cu Ni	076	1601650-1	L076C16A
18-14 0.80-2.00	<b>.040-.063</b> 1.02-1.60	1600-4000	<b>.016</b> 0.41	<b>.138</b> 3.51	Brass	076	1601651-1	L076C16B
18-14 0.80-2.00	<b>.040-.063</b> 1.02-1.60	1600-4000	<b>.018</b> 0.46	<b>.138</b> 3.51	Cu Ni	076	1601652-1†	L076C18A
18-14 0.80-2.00	<b>.040-.063</b> 1.02-1.60	1600-4000	<b>.018</b> 0.46	<b>.138</b> 3.51	Brass	076	1601827-1	P076C18B
18-14 0.80-2.00	<b>.040-.063</b> 1.02-1.60	1600-4000	<b>.018</b> 0.46	<b>.138</b> 3.51		076	1601654-1†	L076C18TCRS
17½-13 0.95-2.54	<b>.042-.068</b> 1.07-1.80	1800-4600	<b>.016</b> 0.41	<b>.138</b> 3.51	Brass	076/092	1601640-1	L076/ 092C16B
16½-13 1.10-2.60	<b>.047-.072</b> 1.19-1.83	2200-5200	<b>.016</b> 0.41	<b>.138</b> 3.51	Cu Ni	092	1601837-1	P092C16AX
16½-13 1.10-2.60	<b>.047-.072</b> 1.19-1.83	2200-5200	<b>.016</b> 0.41	<b>.138</b> 3.51	Brass	092	1601687-1	L092C16B
15½-12 1.54-3.46	<b>.055-.082</b> 1.40-2.10	3000-6750	<b>.016</b> 0.41	<b>.138</b> 3.51	Tin Plated Brass	125	1601721-1	L125C16TB
15½-12 1.54-3.46	<b>.055-.082</b> 1.40-2.10	3000-6750	<b>.018</b> 0.46	<b>.138</b> 3.51	Cu Ni	125	1601722-1	L125C18A
15½-12 1.54-3.46	<b>.055-.082</b> 1.40-2.10	3000-6750	<b>.018</b> 0.46	<b>.138</b> 3.51	Brass	125	1601723-1	L125C18B

† These part numbers are available upon special request; contact TE engineering for details.

**RTM Crimpband Splices** (Continued) This product line is not recommended for new designs, as the application machines are no longer manufactured.

**3 Ridges**

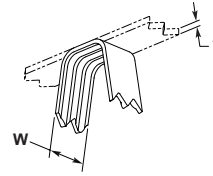

AWG/ mm <sup>2</sup>	Wire Range Solid Dia.	CMA Range	Stock Thk. (T)	Mat'l Width (W)	Material	Toolset	Part Number	Descriptive X-ref
27½-21 0.09-0.40	.013-.028 0.33-0.71	170-800	.012 0.30	.076 1.93	Brass	032	1601555-1	L032B12B
24-20 0.20-0.50	.020-.033 0.51-0.84	400-1100	.012 0.30	.076 1.93	Cu Ni	032/036	1601542-1	L032/ 036B12A
24-20 0.20-0.50	.020-.033 0.51-0.84	400-1100	.012 0.30	.076 1.93	Brass	032/036	1601795-1	P032/ 036B12B
24-20 0.20-0.50	.020-.033 0.51-0.84	400-1100	.016 0.41	.076 1.93	Brass	032/036	1601545-1	L032/ 036B16B
24-20 0.20-0.50	.020-.033 0.51-0.84	400-1100	.016 0.41	.076 1.93	Tin Plated Brass	032/036	1601546-1	L032/ 036B16TB
24-20 0.20-0.50	.020-.033 0.51-0.84	400-1100	.018 0.46	.076 1.93	Brass	032/036	1601547-1†	L032/ 036B18B
22-19 0.38-0.60	.024-.036 0.61-0.91	600-1300	.016 0.41	.076 1.93	Cu Ni	045	1601503-1	G045B16A
22-19 0.38-0.60	.024-.036 0.61-0.91	600-1300	.016 0.41	.076 1.93	Brass	045	1601562-1	L045B16B
22-19 0.38-0.60	.024-.036 0.61-0.91	600-1300	.016 0.41	.076 1.93	Tin Plated Brass	045	1601504-1†	G045B16TB
22-19 0.38-0.60	.024-.036 0.61-0.91	600-1300	.016 0.41	.076 1.93	Tin Plated Brass	045	1601564-1	L045B16TBSP
21-18½ 0.40-0.75	.028-.039 0.71-0.99	800-1500	.016 0.41	.076 1.93	Cu Ni	051	1601580-1†	L051B16A
21-18½ 0.40-0.75	.028-.039 0.71-0.99	800-1500	.016 0.41	.076 1.93	Brass	051	1601582-1†	L051B16B
21-18½ 0.40-0.75	.028-.039 0.71-0.99	800-1500	.016 0.41	.076 1.93	Tin Plated Brass	045	1601583-1†	L051B16TB
21-18½ 0.40-0.75	.028-.039 0.71-0.99	800-1500	.020 0.51	.076 1.93	Brass	051	1601584-1	L051B20B
20½-16 0.45-1.30	.030-.051 0.76-1.29	900-2600	.016 0.41	.076 1.93	Tin Plated Brass	061	1601612-1†	L061B16TB
20½-16 0.45-1.30	.030-.051 0.76-1.29	900-2600	.016 0.41	.076 1.93	Cu Ni	061	1601610-1	L061B16A
20½-16 0.45-1.30	.030-.051 0.76-1.29	900-2600	.016 0.41	.076 1.93	Brass	061	1601611-1	L061B16B
20½-16 0.45-1.30	.030-.051 0.76-1.29	900-2600	.016 0.41	.076 1.93	Brass	061	1601635-1	L061L16B
20-15 0.60-1.60	.033-.057 0.84-1.45	1100-3200	.016 0.41	.076 1.93	Tin Plated Brass	061/076	1601596-1	L061/ 076B16TBX
18-14 0.80-2.00	.040-.063 1.02-1.60	1600-4000	.016 0.41	.076 1.93	Brass	076	1601825-1	P076B16B
18-14 0.80-2.00	.040-.063 1.02-1.60	1600-4000	.020 0.51	.076 1.93	Brass	076	1601649-1	L076B20B

† These part numbers are available upon special request; contact TE engineering for details.

Crimband

## Power Splice

### Product Facts

- Compression crimp eliminates cold solder points, weld burns and wire embrittlement usually connected with thermal-type terminations
- Precisely controlled crimp termination helps eliminate human error, for maximum reliability
- Excellent tensile strength, up to 90 lbs axial retention, vibration resistant
- Provides a superior electrical connection that is free of many contaminants such as stripper residue and solder flux
- 8000 - 38,000 CMA nominal capacity
- Accepts up to six magnet wires and two standard solid or stranded lead wires
- Superior test results: low resistance, high stability
- High termination rates, low wire consumption and the elimination of rejects caused by solder flux or heat damage results in the lowest applied costs

### Applications

- Hermetic/Compressor motors
- Squirrel cage DC motors
- Capacitor start motors
- Gear & Traction motors
- Power supplies
- Liner, Torroid & RF transformers
- Circuit breakers & welders

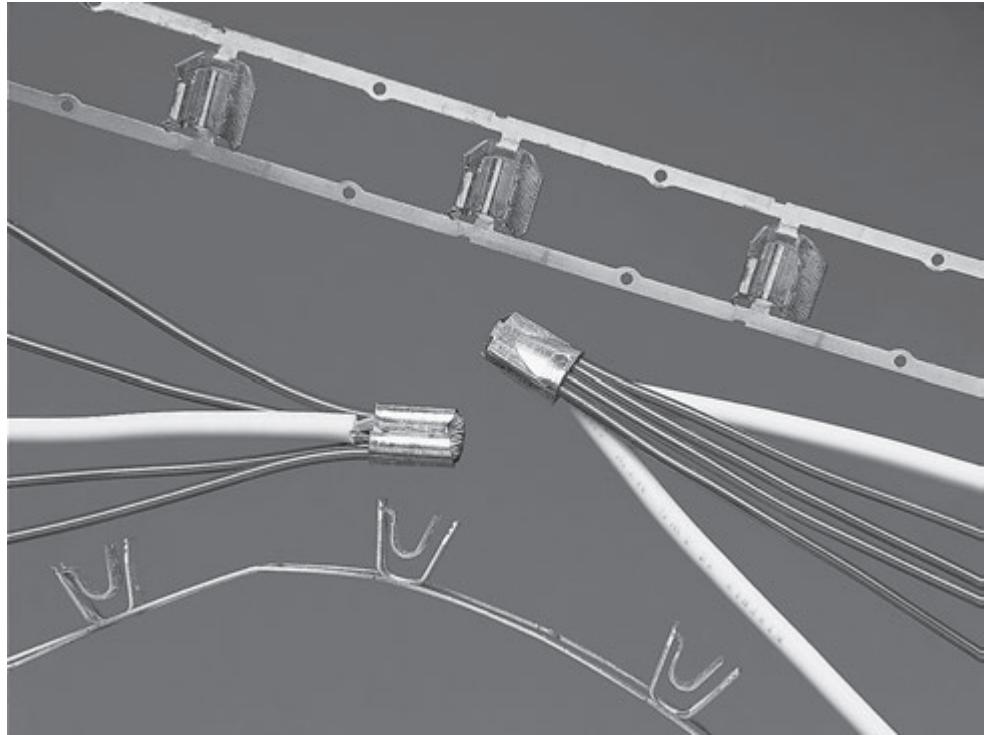

TE features the Power Splice terminal that is specifically designed to terminate a wide range of lead and magnet wire combinations.

The splice contains two cavities that separate and cradle magnet wire and stripped lead wires prior to crimping.

The outer saddle accepts up to six-magnet wire allowing for a CMA range of 15,000 to 30,000.

The inner saddle accepts pre-stripped lead wires that total up to 10,900 CMA.



In a one step automatic operation, the magnet wire film insulation is multiple ring-stripped as it is forced into the serrations while the lead wire is simultaneously terminated during the precisely controlled crimp.

The outer saddle has machined, sharp edges made by a special production process that pierces the insulating layer of the magnet wire in a manner that provides a large contact area.

The resulting termination produces a high tensile strength, air sealed connection that is as resistant to corrosion as the insulated conductor with up to 90 lbs axial retention.

As many as six magnet wires can be terminated simultaneously in one splice in combination with up to two pre-stripped standard solid or stranded lead wire.

A semi-automatic machine provides high output per hour terminations.

**Power Splice** (Continued)

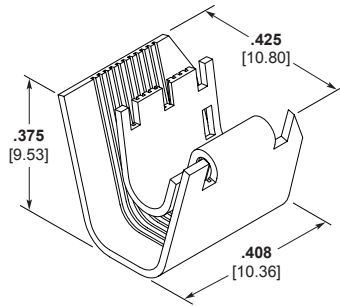

Type	Magnet Wire Range CMA	Lead Wire Range CMA	Part Number Reeled
A	15,000-30,000	4200-10,900	1601953-1 <sup>1</sup>

<sup>1</sup> Total combined CMA not to exceed 38000.

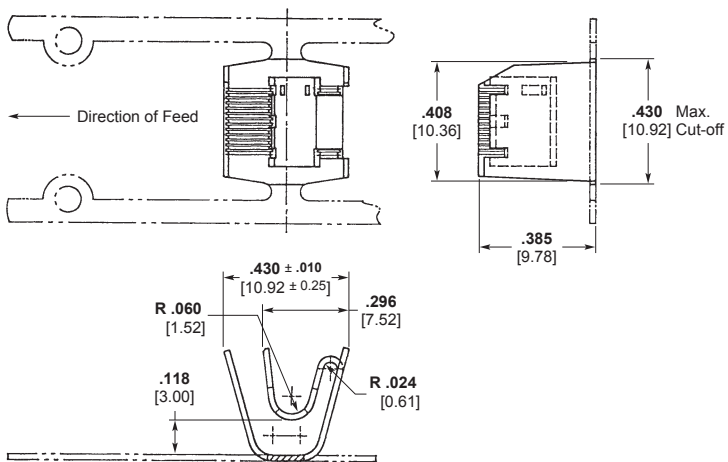
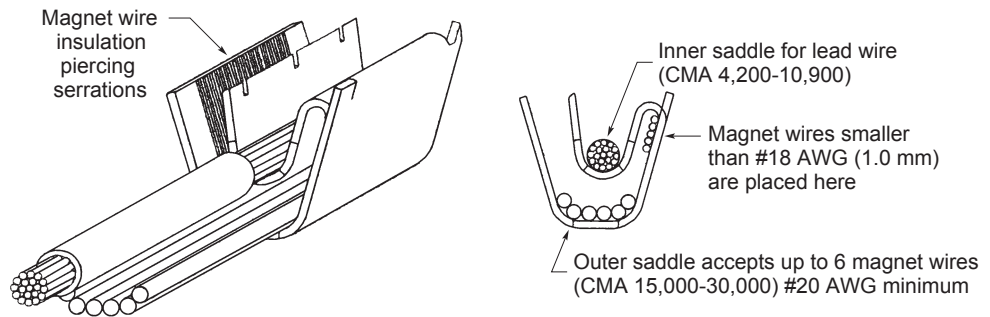

Part Number 111-000-001

Power Splice



## Application Tooling

### Worldwide Leadership in Wire and PCB Manufacturing Products

Leadership demands commitment and TE is committed to meeting manufacturing needs worldwide with technology, products and systems, and service.

#### Application Tooling of TE Connectivity

TE has long been recognized as a leader in providing the tools for wire harness and printed circuit manufacturing. There's a good reason. Our products are designed to meet and anticipate our customers' ever-changing requirements and built to the highest quality standards, for longest, most productive performance lifetimes.

Whatever your production volume and job mix, we can offer the tools to get it done. With a full range of tooling from hand tools to high volume, fully automated systems, TE is able to meet most manufacturing demands worldwide. It's an ability that comes from our experience with manufacturers large and small, giving us a unique view of the trends and challenges in wire harness and PCB manufacturing. It all derives from our commitment to your manufacturing challenges, giving you the advantage in your marketplace.

This catalog is just a sampling of the types of solutions that will make your job easier, faster, more productive and more profitable. Make tooling, assembly equipment, and service from TE part of your thinking, now and as you grow into the future.

#### TE Connectivity Service and Support

Few suppliers can match TE customer service and support. From helping you select the tooling for your requirements to maintenance and repair and analyzing your operation for maximum productivity, our worldwide capabilities and experience will make a real difference in your production and bottom line.

**ProductionChek Service** — In a consultative role, our field engineer will meet with you to determine your objectives and known production issues, then observe and record in detail each step in your operation. Based on this information, the engineer will be able to make recommendations for improvement, typically in people, process or equipment.

**Tool Repair and Certification** — Our field engineers will set up, certify, and repair application tooling on site or recommend our factory-level service. Flexible plans, including options for premium access to parts and service, will keep your PCB assembly automation equipment running at peak performance.

For additional maintenance services, the TE Technical Support Center is dedicated to providing the answers you need, toll-free at 1-800-522-6752. Support contracts are available for preventive maintenance, training, emergency situations and other specific requirements.



*For more information regarding the products and services shown in this brochure, visit our website at [www.tooling.te.com](http://www.tooling.te.com)*

## Application Tooling

### Magnet Wire Crimp Application Equipment

MAG-MATE and AMPLIVAR splices and terminals are available in a wide range of configurations to meet most magnet-wire termination needs. All provide high reliability with minimal wire preparation. TE Connectivity offers a wide variety of magnet-wire termination solutions for thru splicing, pigtail splicing and coil termination.

#### AMPLIVAR Product Terminator (APT) Machines

The new APT 5A magnet wire pigtail splice machine offers a fast, efficient system, with no need to strip mag-wire insulation. Simply place the wires in the target area and depress the foot switch. The machine automatically shears the splice or Direct Connect contact from the strip, crimps it, shears off excess wire, and advances the next splice or contact into position.

APT bench machines are available in two versions: the 5A with automatic precision adjustment controlled by the crimp quality monitor (CQM) and the 5E with manual precision adjustment. Using CQM, the APT 5A provides 100% inspection and automatic adjustment of crimp height. If a questionable crimp is detected, visual and audible alarms alert the operator.

The lower cost, manual adjust APT 5E is a simpler version with the advantage of faster set-up times but without CQM capability.

#### Power Splice Machine

*Not CE approved, contact engineering for quotation.*

The Power Splice Machine and applicator from TE provides reliable pigtail splice termination of magnet wire and solid or stranded lead wire. This machine can terminate pigtail splices consisting of up to two solid or stranded copper lead wires in wire size from 10-14 AWG and having a Circular Mil Area (CMA) of 4,100 - 11,000. The splice will simultaneously accept combinations of multiple copper magnet wires in a range of 11-20 AWG. The total CMA range for lead wire and magnet wire is 4,000 to 40,000.

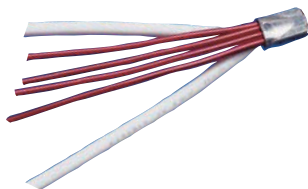

## Application Tooling

### Magnet Wire Crimp Application Equipment

#### **AMPLIVAR Terminator for Parallel and End Connections**

*Primarily sold in Europe.*

The machine was developed for processing magnet wire connections. Different versions for end-feed and side-feed contacts are available. The design takes into account that the motor windings and coils can be supplied directly to the connectors. The exposed crimp position permits precise handling. In case of end connections the projecting magnet wires are cut off.

AMPLIVAR splices and terminals are specifically designed to terminate magnet wires or in combination with standard solid or stranded wire. In a one-step operation the magnet wire is automatically multiple ring stripped of its insulation as it is forced into the serrations during the precisely controlled crimping operation.

As many as three magnet wires can be terminated, simultaneously in one splice. Nearly the entire AMPLIVAR splice program can be applied with this machine in combination with suitable applicators. The comprehensive range of manufacturing possibilities demands a specific machine and applicator combination.

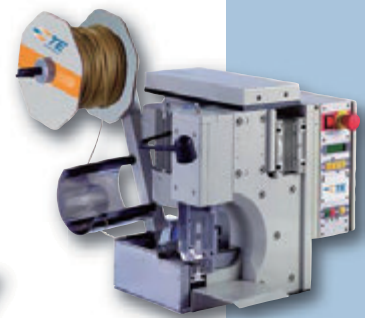

#### **AMP-O-LECTRIC Model G Terminator with Thru-Splice Applicator**

*Not CE Approved.*

Applying thru-splices is fast and efficient when you have access to both sides of the applicator for placing and holding the wires. The AMP-O-LECTRIC model G splice terminator with a standard G splice applicator provides front and rear access to maximize production efficiency. It provides full guarding for operator safety and is available with or without a Crimp Quality Monitor. **Request catalog 889021 for more information.**

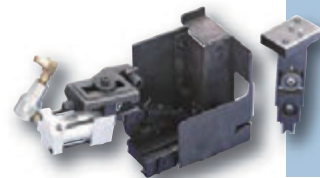

## Application Tooling

### Magnet Wire Crimp Application Equipment

**Crimband application machines have been discontinued and are no longer offered by TE.**

#### Crimband Application Tooling

*Not CE approved, contact engineering for quotation.*

TE offers solderless crimping systems to handle a wide range of wire connections including solid and stranded lead wire, insulated magnet wire, and component leads. Each system is comprised of continuous, serrated Crimband material and a crimping machine. The TE solution allows the flexibility to create a shape and size, which optimizes the crimp's electrical and mechanical performance.

The TE crimping system produces a very economical and reliable interconnection. Utilizing a continuous crimband material the machine will feed, cut form, and crimp your application resulting in a very strong and uniform interconnect crimp.

Whether your application required a wire-to-wire, wire to components leads, wire to terminals, or magnet wire splice termination, the very flexible and dependable crimping machine will provide high-speed scrap free interconnects.

Substantial increase in production interconnection rates can be realized versus traditional soldering. Not to mention it completely eliminates the noxious fumes.

The **mod I crimping system** is used when running standard RTM and MTM crimband product. In addition, left and right horn termination machines are available when your application requires additional working envelope.

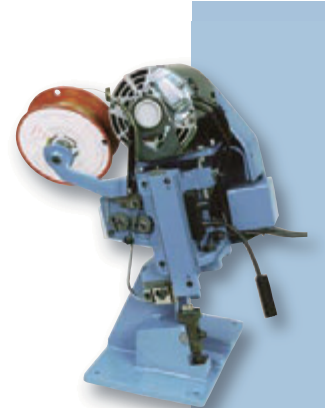
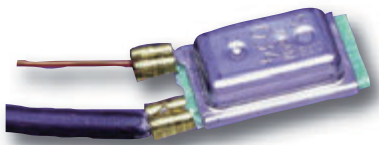

**Application Tooling**

**Magnet Wire MAG-MATE Terminal Application Equipment**

**MPT-5 MAG-MATE Product Terminator**

*Not CE approved, refer to Mark I, Mark II pages 83, 84.*

The MPT-5 is an air-operated machine with microprocessor control that inserts MAG-MATE terminals into customer-designed cavities in the coil bobbin or similar magnet-wire housing, terminating the wire for connectivity. *Please note: The customer designed cavities must follow TE specification guidelines.* Termination of single, dual, triple and up to quadruple termination possible depending on the application details. The machine is available in either vertical or horizontal configuration to match the customer's application.

The dual reel capability of the MPT-5 machine allows insertion of two different MAG-MATE terminals, with the capability to alternate between inserting one and two terminals at a time. The MPT-5 is also capable of trimming excess magnet wire.

The MPT-5 Terminator also has the capability to alternate between inserting 2 bridged (or commoned) terminals and 2 separated terminals.

**Request catalog 1308387 for more information.**

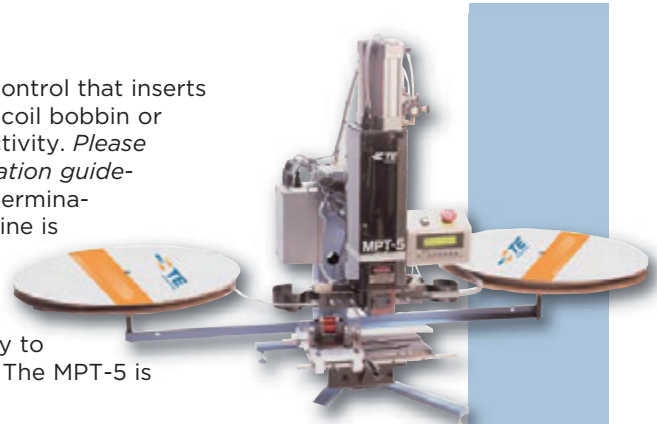

**MAG-MATE Terminal Cavity and Fixture Design**

MAG-MATE terminals insert into a molded-in cavity in the coil bobbin. The bobbin is generally secured in a fixture during the insertion/termination process. TE engineers work with our customers to support cavity and fixture design, at any level. We can provide complete design of cavities and fixtures for customer's applications, work with our customer's engineers, or simply provide CAD models and other engineering data as needed. Consultation early in the design process allows customers maximum benefit from our decades of magnet-wire experience.

**Product Line Integration**

The MPT-5 and APT IIIA Machines have the production capacity and the electronics for easy integration into automated production lines. TE Engineers work with your system integrators to assure the efficiency of TE equipment into the line's design and assembly.

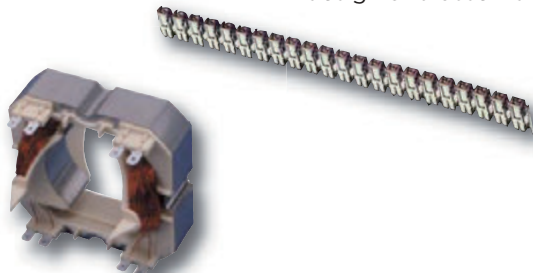

**Application Tooling**

**Magnet Wire MAG-MATE Terminal Application Equipment**

**MPT-5 S/L Machine** (for SIAMEZE and Lead Lok Terminals)

*Not CE approved, refer to Mark I, Mark II pages 83, 84.*

For quick, easy and reliable termination of magnet wire, TE offers the MPT-5 S/L MAG-MATE product terminator — an air-operated insertion machine with microprocessor control.

The MPT-5 S/L machine inserts a SIAMEZE terminal into a customer-designed cavity in the coil bobbin or similar mag-wire housing, terminating the wire for connectivity. Please note: The customer designed cavities must follow TE specification guidelines. It can insert both the SIAMEZE terminal and the Lead Lok terminal to assure your lead wire connection. The MPT-5 S/L offers dual reel capability and is also capable of trimming excess magnet wire. The dual reel capability of the MPT-5 S/L allows insertion of two different SIAMEZE terminals, with the capability to alternate between inserting one and two terminals at a time.

The MPT-5 S/L machine is available as a horizontal or vertical bench machine or as a discrete module for integration into automated lines.

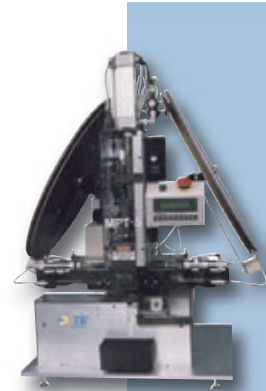

**MPT-5 S/L**



**EMT — Entry Level Magnet Wire Terminator**

(for loose piece SIAMEZE, Lead Lok, or MAG-MATE Terminals)

*Not CE approved, contact engineering for quotation.*

The Entry Level Magnet Wire Terminator tube design is based on the proven MPT-5 system and incorporates a fine adjust mechanism for easy set-up. The floating tube bottoms on the top of the terminal cavity to create the datum for the insertion depth of the terminal. The insertion depth can be adjusted in .002" [.05 mm] increments quickly and easily.

An unobstructed view of the tube bottom permits the operator to easily load loose piece terminals. A two-handed actuation system protects the operators during the insertion process and the open architecture design allows operators to easily load and unload the stators on and off the fixture.



**Entry Level Terminator**



**Application Tooling**

**Magnet Wire MAG-MATE Terminal Application Equipment**

**Manual Hand Tool**

(for loose piece SIAMEZE, Lead Lok, or MAG-MATE Terminals)

- Inserts loose piece terminals into molded cavities
- Insertion depth is repeatable due to the hand tools design which requires the operator to fully compress the handle before it is allowed to retract
- Since tooling captures the cavities during insertion, no fixturing is needed
- Hand tools are available quickly for prototyping, repair, and/or low volume applications

*\*\* The manual hand tool is not compatible with every application. Please contact TE Connectivity for more information.*



**Manual Hand Tool**

**Manual Arbor Press**

(for loose piece SIAMEZE, Lead Lok, or MAG-MATE Terminals)

- Inserts loose piece terminals into molded cavities
- One tip is capable of inserting the SIAMEZE wire-to-wire terminal, the lead wire and the Lead Lok terminal
- Insertion tip bottoms on the top of the cavity to provide repeatable insertion depth capability
- Customers often supply their own fixtures for prototyping or low volume requirements
- Tips, arbor presses, and CERTI-LOK hand tools are available quickly for prototyping applications requirements

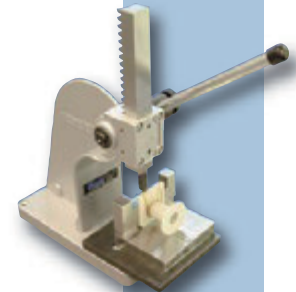

**Manual Arbor Press**

**Hand Insertion Tools**

- Inserts loose piece terminals into molded cavities
- Available quickly for prototyping application requirements
- Available for each type of MAG-MATE terminal

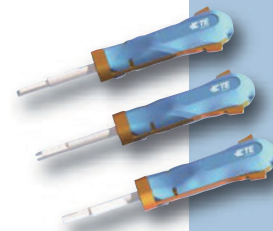

**Insertion Tools**

**Full Line of Crimp Tooling**

- TE offers a full line of hand tools, bench equipment, and automatic machines to perform the wire crimps for the mating end of these MAG-MATE connections.

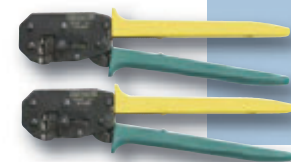

**CERTI-LOK Tools**

**Application Tooling**

**Magnet Wire MAG-MATE Terminal Application Equipment**

**MAG-MATE Inserter MK I with Pneumatic Control,**  
*Primarily sold in Europe.*

- Single, dual, triple and quadruple insertion
- Module easily integrated into production lines using simple handshake signals
- Holding fixture for bobbin can be designed and built by TE
- Can apply standard MAG-MATE and SIAMEZE terminals
- Load-while-running feature increases productivity
- Cycle time: 0.9 - 1.3 s depending on terminal type
- Mechanical insertion force limiter optional

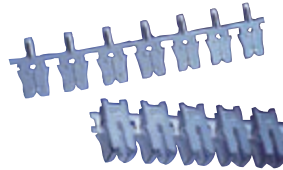

**MK I Inserter**

**MAG-MATE Inserter MK I with Electro Pneumatic Control (PLC),**  
*Primarily sold in Europe.*

- Single contact
- Double contacts with or without bridge
- 2 single contacts alternately with 2 bridged contacts
- Module is easily integrated into customer's production line using simple handshake signals
- Terminations up to 4 terminals at a time as single or linked type
- Mechanical insertion force limiter optional



**Mark II Inserter with PLC**

**MAG-MATE and SIAMEZE Inserter Mark II with PLC,**  
*Primarily sold in Europe.*

TE magnet wire terminations are a perfect connecting alternative to all soldering techniques used in a lead-free environment. Special knowledge is required to design a mass manufacturing line for insulation displacement crimps on thin lacquered insulated wires with high yield. Design aspects of the terminal, the cavity and the machine all need to be harmonized. With the Inserter Mark II, TE can offer an economic solution especially for the application of MAG-MATE and SIAMEZE terminals.

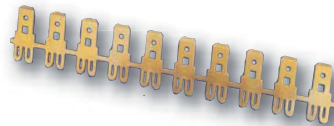

**Application Tooling**

**Magnet Wire MAG-MATE Terminal Application Equipment**

**MAG-MATE and SIAMEZE Inserter Mark II with PLC and Insertion Force Control,**  
*Primarily sold in Europe.*

This advanced insertion machine provides the features of the MAG-MATE inserter Mark II with an additional force distance control system. The machine is designed to apply multiple different contacts and will be customized according to the customer or product specific requirement. The contacts can be used as single contacts or in strip form (bridge function adjusted "on-the-fly").

A gauge is available to check the adjusted insertion force and to recalibrate the insertion force control sensor.

**Request catalog 7-1773440-4 for more information.**

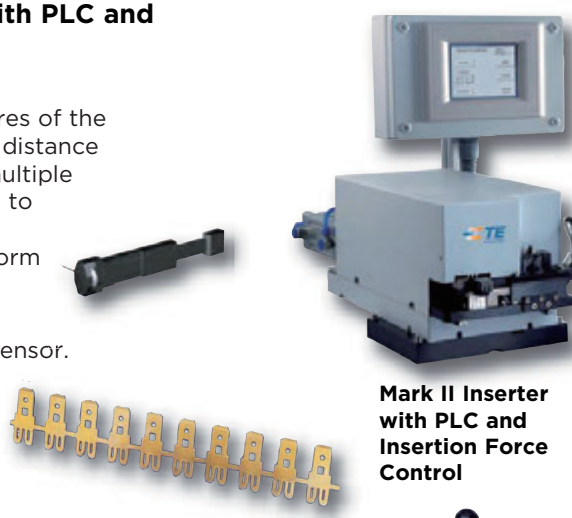

**Mark II Inserter with PLC and Insertion Force Control**

**Pneumatic Insertion Tool for MAG-MATE Terminals,**  
*Primarily sold in Europe.*

The pneumatic tool for MAG-MATE terminals features a rotary insertion finger to facilitate different insertion angles.

This tool is designed for use in TE standard insertion machines such as P200 and P300 but can also be integrated into customized production lines or assembly cells.

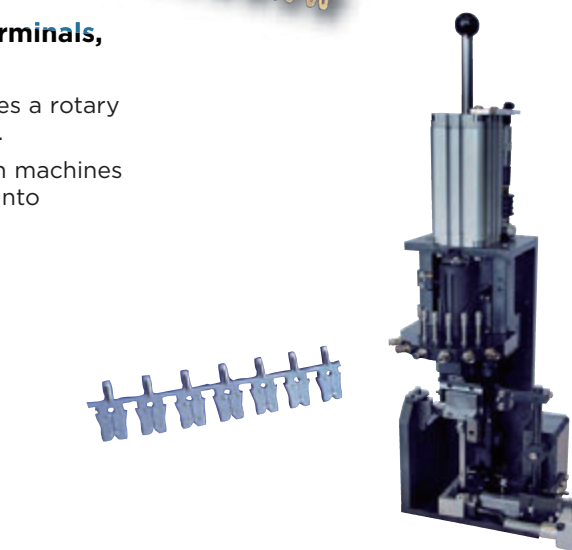

**Pneumatic Insertion Tool**

**Application Tooling**

**Magnet Wire MAG-MATE Terminal Application Equipment**

**Customer Specific Machines**

This unique machine was developed to process all IDC terminals regardless of shape and configuration. The insertion head module is capable of inserting individual or multiple terminals and can be configured for dual feed, left and right hand supply reels.

The servo-driven NC-Axis facilitates precisely controlled insertion with programmable ramp profile. If required, a servo driven torque motor will locate the stator/bobbin to programmable positions.

Excess magnet wire and wrap post are cut-off during the insertion cycle and removed via a ventury. The cutting punches are cam actuated via our patented linear slide module.

The machine is designed and built for easy maintenance. Spare parts (punches, insertion blades, trim blades, die plate inset) are easy to access and replace.



**Custom Built IDC Terminal Insertion Head**

The insertion head module is designed to be integrated into a rotary index or linear transfer line. The IDC terminal insertion can be in vertical or horizontal plane. The terminal strip feeds from the right and/or from the left, if necessary with 2 different terminal configurations.

Wrap posts and excess magnet wire can be removed via a trim blade. Insertion force monitoring is available as an option.

The insertion head module is custom built according to your requirements.

**Request catalog 7-1773440-4 for more information.**

**Cam driven linear slide module for punch actuation.**

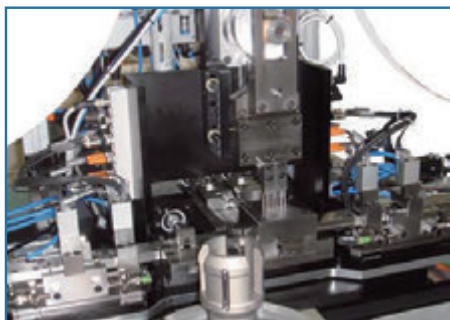

**Horizontal Design**



**Vertical Design**

**Technical Information**

**Tensile Strength of Magnet Wire<sup>1</sup>**

Wire Size	Nominal Dia. Copper (lbs.)	Nominal Dia. Aluminum (lbs.)
8	438	142
9	340	113
10	269	89
11	213	71
12	189	56
13	134	44
14	106	35
15	84	28
16	66	22
17	53	17
18	42	14
19	33	11
20	6	8
21	21	7
22	16	5
23	13	4
24	10	3
25	8	2.7
26	6	2.1
27	5	1.7
28	4	1.3
29	3	1.1
30	2	.86
31	2	.68
32	1	.55
33	1	.43
34	1	.34
35	.81	.27
36	.65	.21
37	.65	.21
38	.42	.13
39	.32	.10
40	.25	.083
41	.20	.067
42	.16	.054
43	.12	.041
44	.10	.034
45	.08	.027
46	.06	.022
47	.05	.017
48	.04	.013
49	.03	.010
50	.02	.009
51	.02	.007
52	.01	.005

C.	F.	C.	F.	C.	F.	C.	F.
-80	-112.0	9	48.2	47	116.6	85	185.0
-70	-94.0	10	50.0	48	118.4	86	186.8
-60	-76.0	11	51.8	49	120.2	87	188.6
-50	-58.0	12	53.6	50	122.0	88	190.4
-45	-49.1	13	55.4	51	123.8	89	192.2
-40	-40.0	14	57.2	52	125.6	90	194.0
-35	-31.0	15	59.0	53	127.4	91	195.8
-30	-22.0	16	60.8	54	129.2	92	197.6
-25	-13.0	17	62.6	55	131.0	93	199.4
-20	- 4.0	18	64.4	56	132.8	94	201.2
-19	- 2.2	19	66.2	57	134.6	95	203.0
-18	- .4	20	68.0	58	136.4	96	204.8
-17	1.4	21	69.8	59	138.2	97	206.6
-16	3.2	22	71.6	60	140.0	98	208.4
-15	5.0	23	73.4	61	141.8	99	210.2
-14	6.8	24	75.2	62	143.6	100	212.0
-13	8.6	25	77.0	63	145.4	110	230.0
-12	10.4	26	78.8	64	147.2	120	248.0
-11	12.2	27	80.6	65	149.0	130	266.0
-10	14.0	28	82.4	66	150.8	140	284.0
- 9	15.8	29	84.2	67	152.6	150	302.0
- 8	17.6	30	86.0	68	154.4	160	320.0
- 7	19.4	31	87.8	69	156.2	170	338.0
- 6	21.2	32	89.6	70	158.0	180	356.0
- 5	23.0	33	91.4	71	159.8	190	374.0
- 4	24.8	34	93.2	72	161.6	200	392.0
- 3	26.6	35	95.0	73	163.4	220	428.0
- 2	8.4	36	96.8	74	165.2	240	464.0
- 1	30.2	37	98.6	75	167.0	260	500.0
0	32.0	38	100.4	76	168.8	280	536.0
1	33.8	39	102.2	77	170.6	300	572.0
2	35.6	40	104.0	78	172.4	400	752.0
4	39.2	42	107.6	80	176.0	600	1112.0
5	41.0	43	109.4	81	177.8	700	1292.0
6	42.8	44	111.2	82	179.6	800	1472.0
7	44.6	45	113.0	83	181.4	900	1652.0
8	46.4	46	114.8	84	183.2	1000	1832.0

C = 5/9 (F - 32)  
 F = 9/5 C + 32

<sup>1</sup> Magnet wire tensile will change as the psi of magnet wire changes.

**Note:** Copper magnet wire is calculated at 33,000 psi. Aluminum magnet wire is calculated at 11,000 psi (EC grade). Magnet wire should be tensiled on each coil. After termination of the AMPLIVAR splice, the tensile strength will be 70% (min.) of the original magnet wire tensile values.

**Technical Information** (Continued)

**Circular Mil Area (CMA) and diameter for magnet wires (AWG wire size range 52–25 1/2)**

AWG Bare Wire	Bare Wire Dia.		CMA Bare	Single Film Coated Dia.		CMA Single Film Coated	Heavy Film Coated Dia.		CMA Heavy Film Coated
	in.	mm		in.	mm		in.	mm	
52	.0008	.020	0.6	.0010	.025	1.0	.0011	.028	1.2
51	.0009	.023	0.8	.0011	.028	1.2	.0012	.031	1.5
50	.0010	.025	1.0	.0012	.031	1.5	.0013	.033	1.7
49	.0011	.028	1.2	.0013	.033	1.7	.0014	.035	2.0
48	.0012	.031	1.5	.0014	.035	2.0	.0015	.038	2.2
47	.0014	.035	2.0	.0016	.040	2.5	.0018	.045	3.1
46	.0016	.040	2.5	.0017	.043	2.9	.0019	.048	3.6
45	.0018	.045	3.1	.0019	.048	3.6	.0021	.053	4.4
44	.0020	.050	4.0	.0022	.056	4.8	.0025	.063	6.2
43	.0022	.056	4.8	.0025	.063	6.2	.0027	.069	7.3
42	.0025	0.06	6.3	.0028	0.07	8	.0030	0.08	9
41	.0028	0.07	7.8	.0031	0.08	10	.0034	0.09	12
40	.0031	0.08	9.6	.0035	0.09	12	.0038	0.10	14
39	.0035	0.09	12	.0039	0.10	15	.0043	0.11	18
38	.0040	0.10	16	.0045	0.11	20	.0049	0.12	24
37	.0045	0.11	20	.0050	0.13	25	.0055	0.14	30
36	.0050	0.13	25	.0056	0.14	31	.0060	0.15	36
35	.0056	0.14	31	.0062	0.16	38	.0067	0.17	45
35	.0056	0.14	31	.0062	0.16	38	.0067	0.17	45
34	.0063	0.16	40	.0069	0.18	48	.0075	0.19	56
33	.0071	0.18	50	.0077	0.20	59	.0085	0.22	72
32	.0080	0.20	64	.0084	0.21	71	.0095	0.24	90
31	.0089	0.23	79	.0092	0.23	85	.0105	0.27	110
30 1/2	.0095	0.24	90	.0099	0.25	98	.0111	0.28	123
30	.0100	0.25	100	.0106	0.27	112	.0116	0.29	135
29 1/2	.0107	0.27	115	.0114	0.29	130	.0123	0.31	151
29	.0113	0.29	128	.0120	0.30	144	.0130	0.33	169
28 1/2	.0120	0.30	144	.0126	0.32	159	.0137	0.35	187
28	.0126	0.32	159	.0136	0.35	185	.0144	0.37	207
27 1/2	.0134	0.34	180	.0144	0.37	207	.0153	0.39	234
27	.0142	0.36	202	.0152	0.39	231	.0161	0.41	259
26 1/2	.0151	0.38	225	.0160	0.41	256	.0170	0.43	289
26	.0159	0.40	258	.0170	0.43	289	.0179	0.45	320
25 1/2	.0169	0.43	289	.0180	0.46	324	.0190	0.48	361



**Technical Information** (Continued)

**Circular Mil Area (CMA) and diameter for magnet wires (AWG wire size range 25–8)**

AWG Bare Wire	Bare Wire Dia.		CMA Bare	Single Film Coated Dia.		CMA Single Film Coated	Heavy Film Coated Dia.		CMA Heavy Film Coated
	in.	mm		in.	mm		in.	mm	
25	.0179	0.45	320	.0190	0.48	361	.0200	0.51	400
24 <sup>1/2</sup>	.0190	0.48	361	.0200	0.51	400	.0212	0.54	449
24	.0201	0.51	404	.0213	0.54	455	.0223	0.57	497
23 <sup>1/2</sup>	.0214	0.54	458	.0226	0.57	511	.0236	0.60	557
23	.0226	0.57	511	.0238	0.60	566	.0249	0.63	620
22 <sup>1/2</sup>	.0240	0.61	576	.0252	0.64	635	.0263	0.67	692
22	.0253	0.64	640	.0266	0.68	708	.0277	0.70	767
21 <sup>1/2</sup>	.0269	0.68	724	.0282	0.72	795	.0293	0.74	858
21	.0285	0.72	812	.0298	0.76	888	.0310	0.79	961
20 <sup>1/2</sup>	.0303	0.77	918	.0315	0.80	992	.0328	0.83	1,076
20	.0320	0.81	1,024	.0334	0.85	1,116	.0346	0.88	1,197
19 <sup>1/2</sup>	.0340	0.86	1,156	.0353	0.90	1,246	.0365	0.93	1,340
19	.0359	0.91	1,289	.0373	0.95	1,391	.0386	0.98	1,490
18 <sup>1/2</sup>	.0381	0.97	1,452	.0395	1.00	1,560	.0409	1.04	1,673
18	.0403	1.02	1,624	.0418	1.06	1,747	.0431	1.09	1,858
17 <sup>1/2</sup>	.0428	1.09	1,832	.0443	1.13	1,962	.0456	1.16	2,079
17	.0453	1.15	2,052	.0468	1.19	2,190	.0482	1.22	2,323
16 <sup>1/2</sup>	.0481	1.22	2,314	.0496	1.26	2,460	.0510	1.30	2,601
16	.0508	1.29	2,581	.0524	1.33	2,746	.0583	1.37	2,894
15 <sup>1/2</sup>	.0540	1.37	2,916	.0560	1.42	3,136	.0570	1.45	3,249
15	.0571	1.45	3,260	.0587	1.49	3,446	.0602	1.53	3,624
14 <sup>1/2</sup>	.0606	1.54	3,672	.0622	1.58	3,869	.0639	1.62	4,082
14	.0641	1.63	4,109	.0658	1.67	4,330	.0675	1.71	4,556
13 <sup>1/2</sup>	.0681	1.73	4,638	.0698	1.77	4,872	.0711	1.81	5,055
13	.0720	1.83	5,184	.0738	1.87	5,446	.0749	1.90	5,670
12 <sup>1/2</sup>	.0764	1.94	5,837	.0783	1.99	6,131	.0793	2.01	6,188
12	.0808	2.05	6,529	.0827	2.10	6,839	.0838	2.13	7,090
11 <sup>1/2</sup>	.0858	2.18	7,362	.0877	2.23	7,691	.0888	2.26	7,885
11	.0907	2.30	8,226	.0927	2.35	8,593	.0938	2.38	8,892
10 <sup>1/2</sup>	.0963	2.35	9,274	.0983	2.50	9,663	.0994	2.52	9,880
10	.1019	2.59	10,384	.1040	2.64	10,820	.1050	2.67	11,151
9	.1144	2.91	13,087	.1166	2.96	13,600	.1177	2.99	13,971
8	.1285	3.26	16,512	.1307	3.32	17,080	.1318	3.35	17,530

**Technical Information** (Continued)

**Circular Mil Area (CMA) and diameter for lead wires (AWG wire size range 30–8)**

Wire Size	Strands		Wire Area in Circ. Mils
	No.	Dia. (Mils)	
30	7	4.0	112
30	1	10.0	100
28	7	5.0	175
28	19	3.1	181
28	1	12.6	159
27	7	5.6	219
27	1	14.2	202
26	6	6.3	238
26	10	5.0	250
26	16	4.0	256
26	8	5.6	251
26	1	15.9	253
26	26	3.1	250
26	7	6.3	278
26	3	10.0	300
26 AN	12	5.0	300
25	10	5.6	314
25	8	6.3	318
25	1	17.9	320
24	10	6.3	397
24	8	7.1	403
24	16	5.0	400
24	4	10.0	400
24	1	20.1	404
24	26	4.0	416
24	13	5.6	408
24	7	8.0	448
24	56	2.8	439
24 AN	19	5.0	475
23	10	7.1	504
23	8	8.0	512
23	1	22.6	511
—	21	5.0	525
22	6	10.0	600
22	8	8.9	634
22	16	6.3	635
22	10	8.0	640
22	1	25.3	640
22	7	10.0	700
22 AN	19	6.3	754
20	10	10.0	1,000
20	1	10.0	1,024
20	26	6.3	1,032
20	7	12.6	1,111
20 AN	19	7.9	1,186
18	19	9.2	1,608
—	16	10.0	1,600
18	1	40.3	1,624
18	7	15.2	1,617
18	65	5.0	1,625
18	7	15.3	1,639

Wire Size	Strands		Wire Area in Circ. Mils
	No.	Dia. (Mils)	
—	41	6.3	1,627
—	7	16.0	1,792
18 AN	19	10.0	1,900
18 AN	19	11.3	2,426
16	7	19.2	2,580
16	1	50.8	2,581
16	65	6.3	2,580
16	19	11.7	2,601
16	105	5.0	2,625
—	26	10.0	2,600
16	7	20.0	2,800
14 AN	19	14.2	3,831
14	37	10.5	4,079
14	7	24.2	4,099
14	19	14.7	4,106
14	1	64.4	4,109
—	41	10.0	4,100
14	105	6.3	4,167
14	168	5.0	4,200
14	84	7.1	4,234
—	7	25.3	4,481
12	19	17.9	6,088
12 AN	19	17.9	6,088
12	259	5.0	6,475
12	19	18.5	6,503
12	7	30.5	6,512
12	37	13.3	6,545
12	1	80.8	6,529
12	165	6.3	6,549
12	84	8.9	6,654
10	7	36.0	9,072
—	37	16.0	9,472
10	414	5.0	10,350
10	37	16.7	10,319
10	1	101.9	10,384
10	7	38.5	10,376
10	19	23.4	10,404
—	41	15.9	10,365
10	105	10.0	10,500
9	7	43.0	12,943
9	1	114.4	13,087
9	525	5.0	13,125
8	7	45.0	14,175
8	133	11.1	16,386
8	37	21.1	16,472
8	1	128.5	16,512
8	7	48.6	16,533
8	19	29.5	16,534
8	49	18.4	16,589
8 AN	133	11.3	16,982





















**Terminal Stud Hole Size**

**Use to Select Proper Size Terminal**

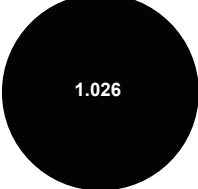
The chart shows sizes and dimensions of various studs and the corresponding terminal stud hole sizes used with devices.

For example, with stud #5 (.125 [3.18] Diameter), use device listed for #5 stud (.129 [3.28] Hole Diameter).

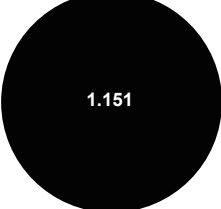
Terminal stud hole sizes may easily be checked by fitting sample terminal to black circle.

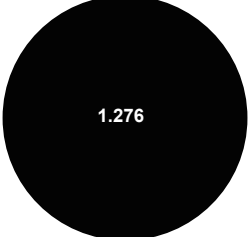
Stud Size		Stud Dia.	Minimum Terminal Hole Diameter	Stud Size		Stud Dia.	Minimum Terminal Hole Diameter	
U.S. Cust.	Metric			U.S. Cust.	Metric			
#0		.060		.064				
#1		.073		.077	5/8"	M16	.625	
#2	M2	.086		.090				
#3		.099		.103				
#4		.112		.116	3/4"		.750	
#5	M3	.125		.129				
#6	M3.5	.138		.142				
#8	M4	.164		.168	7/8"	M22	.875	
#10		.190		.194				
#12		.216		.220				
#14		.242		.247	1"		1.000	
1/4"	M6	.250		.260				
5/16"	M8	.312		.323				
3/8"		.375		.385	1-1/8"		1.125	
7/16"		.437		.448				
1/2"	M12	.500		.510	1-1/4"		1.250	

**Part Number Index**

**Note:** This index lists all cataloged parts by base no. only. Complete part nos. (with prefixes and/or suffixes) are shown on the page(s) indicated.

Part No.	Page	Part No.	Page	Part No.	Page
41765	48	62445	53	63240	10
41766	48	62447	53	63253	11
41770	48	62458	10	63273	18
41899	48	62459	10	63277	16
41900	48	62511	18	63278	16
41904	48	62512	18	63309	21
42076	48	62513	18	63340	19
42119	48	62514	18	63353	20
42192	48	62600	21	63364	7
42776	48	62606	30	63397	7
42778	48	62609	10	63399	51
42779	48	62610	10	63403	21
42780	48	62651	21	63410	7
60177	55	62652	21	63425	22
60318	51	62670	49	63427	20
60319	51	62678	18	63429	19
60320	51	62702	13	63431	49
60321	51	62743	19	63443	16
60322	51	62755	51	63444	16
60323	51	62780	30	63446	51
60325	51	62781	30	63448	59
60384	54	62833	4	63453	61
60385	54	62835	51	63454	61
60752	52	62888	19	63455	61
61074	48	62891	7	63458	8
61151	52	62896	7	63459	22
61166	49	62897	7	63460	22
61440	53	62898	7	63461	18
61442	53	62904	18	63463	14
61710	52	62922	53	63464	22
62000	47	62923	22	63465	22
62001	47	62928	11	63480	56
62002	47	62935	4	63484	53
62040	47	62938	13	63486	17
62044	49	62958	11	63489	14
62069	54	62992	10	63495	22
62080	54	63018	18	63499	21
62131	59	63026	21	63504	10
62157	47	63027	21	63506	55
62194	49	63036	10	63561	48
62200	47	63039	10	63562	48
62201	47	63062	17	63564	48
62243	61	63063	17	63565	13
62244	61	63064	22	63569	16
62295	47	63107	19	63570	16
62303	47	63108	19	63571	21
62304	47	63109	19	63584	18
62305	47	63128	21	63585	18
62306	47	63132	21	63591	4
62307	47	63136	54	63601	21
62308	47	63140	54	63607	21
62309	47	63145	17	63612	51
62310	47	63147	51	63613	30
62311	47	63155	22	63614	21
62341	49	63160	13	63621	49
62381	56	63165	54	63622	54
62420	4	63199	31	63623	54
62429	4	63216	14	63632	6
62430	13	63218	7	63641	10
62431	4	63235	10	63649	51
62438	13	63236	10	63658	4
62439	13	63237	10	63659	11

**Part Number Index**

Part No.	Page	Part No.	Page	Part No.	Page	Part No.	Page
63660	11	63942	55	964114	5	1217529	31
63661	11	63964	56	964156	47	1217533	6
63662	4	63965	14	964252	5	1217538	9
63663	18	63972	14	964290	7	1217579	6
63664	18	63973	14	964337	5	1217592	19
63665	18	63974	14	964338	5	1217593	14
63666	20	63975	6	964339	5	1217595	14
63667	20	63983	20	964340	5	1217596	14
63670	18	63995	20	964341	5	1217613	9
63675	31	63996	20	969082	5	1217624	55
63690	10	160809	13	969125	8	1217666	26
63710	26	160810	13	1123655	59	1217688	6
63711	26	160897	13	1217004	19	1217689	6
63712	26	170063	59	1217011	4	1217690	6
63713	26	171370	58	1217013	13	1217691	6
63714	26	235080	58	1217029	53	1217745	14
63716	26	281006	58	1217041	8	1217746	14
63717	26	281622	7	1217042	20	1217783	17
63718	26	281633	7	1217065	18	1217835	54
63719	26	284937	41	1217067	6	1217853	9
63720	26	293029	40	1217068	6	1217858	9
63734	26	293214	38	1217069	6	1217860	21
63735	26	316300	18	1217072	53	1217870	21
63736	26	350571	52	1217073	53	1217902	20
63737	26	353937	59	1217075	20	1217924	21
63738	26	356462	55	1217090	20	1217973	9
63740	26	360033	58	1217128	18	1247000	11
63741	26	360050	58	1217146	10	1247001	11
63742	26	360051	60	1217152	21	1247002	11
63743	26	360052	60	1217172	61	1247003	11
63744	26	466010	54	1217173	61	1247004	11
63746	17	466510	53	1217174	61	1380145	58
63762	20	466816	54	1217175	61	1394403	15
63772	16	485044	51	1217176	61	1394429	12
63775	7	485079	51	1217181	60	1394430	12
63776	18	505036	52	1217186	60	1394431	12
63777	17	505044	52	1217187	60	1394432	12
63778	31	505071	51	1217196	13	1394433	12
63782	19	505072	51	1217200	60	1394475	15
63786	4	505075	51	1217209	9	1394476	15
63788	16	505079	52	1217221	6	1394638	15
63789	4	520995	60	1217234	4	1394639	15
63795	30	521078	58	1217261	60	1418686	8
63806	14	565435	53	1217262	58	1534110	8
63807	14	566410	55	1217264	59	1534234	5
63808	14	566411	55	1217302	11	1534684	26
63810	14	567343	54	1217324	8	1534685	26
63816	22	567451	54	1217339	20	1534686	26
63818	13	640212	52	1217355	6	1534687	26
63819	13	680353	55	1217356	6	1599105	59
63827	17	880631	58	1217357	6	1601000	36
63844	30	926850	5	1217358	6	1601002	41
63856	10	926851	5	1217368	4	1601005	39
63864	52	926852	5	1217384	48	1601006	40
63870	53	928770	5	1217405	13	1601009	38
63871	53	928771	5	1217406	8	1601011	40
63888	27	928854	5	1217417	55	1601013	40
63889	53	964101	7	1217457	9	1601018	40
63899	14	964106	5	1217458	9	1601020	40
63903	27	964108	5	1217493	19	1601021	40
63940	55	964110	5	1217497	26	1601028	41
63941	55	964111	5	1217516	26	1601033	40

**Part Number Index**

Part No.	Page	Part No.	Page	Part No.	Page	Part No.	Page
1601035	40	1601436	42	1601611	73	1601721	72
1601037	38	1601437	42	1601612	73	1601722	72
1601039	39	1601438	42	1601614	72	1601723	72
1601041	38	1601440	42	1601617	72	1601726	71
1601045	39	1601447	42	1601618	72	1601729	71
1601046	36	1601475	42	1601619	72	1601730	71
1601049	40	1601503	73	1601620	70	1601731	71
1601052	41	1601504	73	1601623	70	1601733	71
1601056	36	1601507	70	1601625	70	1601750	64
1601058	40	1601511	72	1601628	70	1601754	71
1601059	39	1601513	72	1601629	70	1601755	71
1601061	41	1601514	70	1601630	70	1601761	64
1601063	38	1601520	69	1601631	70	1601764	71
1601064	39	1601528	71	1601632	68	1601765	71
1601066	38	1601529	71	1601633	68	1601766	71
1601068	40	1601531	71	1601635	73	1601768	69
1601072	40	1601532	71	1601637	65	1601769	68
1601073	39	1601538	65	1601639	64	1601771	68
1601074	36	1601539	65	1601640	72	1601793	65
1601075	37	1601540	65	1601642	71	1601794	64
1601077	37	1601542	73	1601644	65	1601795	73
1601095	38	1601545	73	1601646	65	1601797	69
1601097	39	1601546	73	1601647	65	1601798	69
1601099	38	1601547	73	1601649	73	1601800	65
1601104	38	1601548	72	1601650	72	1601807	69
1601110	38	1601549	72	1601651	72	1601808	72
1601112	39	1601550	69	1601652	72	1601809	72
1601115	41	1601551	69	1601654	72	1601810	72
1601117	36	1601553	69	1601655	70	1601811	70
1601118	41	1601555	73	1601656	70	1601814	64
1601119	38	1601559	65	1601658	70	1601818	70
1601120	38	1601560	65	1601660	70	1601819	70
1601128	38	1601562	73	1601661	70	1601820	70
1601133	39	1601564	73	1601664	70	1601823	64
1601136	36	1601566	72	1601665	70	1601824	64
1601137	37	1601569	72	1601667	70	1601825	73
1601138	38	1601571	72	1601668	70	1601827	72
1601139	41	1601572	69	1601669	69	1601828	70
1601140	36	1601573	69	1601675	65	1601829	70
1601142	40	1601575	68	1601677	64	1601832	65
1601155	38	1601577	68	1601678	64	1601833	64
1601159	41	1601578	68	1601680	71	1601835	64
1601161	41	1601580	73	1601681	71	1601837	72
1601174	40	1601582	73	1601682	71	1601841	71
1601194	39	1601583	73	1601683	65	1601842	64
1601196	37	1601584	73	1601687	72	1601844	65
1601204	39	1601586	72	1601689	71	1601845	65
1601214	38	1601587	70	1601691	71	1601846	64
1601226	40	1601588	70	1601693	71	1601847	64
1601232	37	1601591	70	1601694	71	1601848	64
1601237	36	1601593	68	1601695	71	1601852	71
1601243	38	1601596	73	1601705	64	1601853	68
1601421	42	1601597	72	1601706	64	1601857	64
1601424	42	1601599	72	1601707	64	1601953	75
1601425	42	1601600	72	1601709	71	1718165	30
1601426	42	1601601	70	1601710	71	1740417	15
1601427	42	1601603	70	1601711	71	1740418	15
1601431	42	1601604	65	1601712	71	1740419	15
1601432	42	1601606	65	1601716	65	1740574	5
1601433	42	1601607	64	1601717	64	1740603	8
1601434	42	1601608	64	1601718	64	1740698	8
1601435	42	1601610	73	1601719	64	1740829	26



**Part Number Index**

Part No.	Page	Part No.	Page	Part No.	Page	Part No.	Page
1742125	7	1742708	11	1855633	55	1987226	28
1742159	9	1742781	9	1855634	55	2120743	27
1742160	18	1742819	20	1855680	55	2120744	27
1742167	14	1742820	20	1855681	55	2120745	27
1742203	6	1742828	7	1955415	58	2120746	27
1742211	8	1742881	55	1969357	58	2120747	27
1742347	6	1742882	55	1987143	12	2232326	58
1742398	21	1742898	47	1987199	8	2232327	58
1742410	8	1742964	59	1987222	28	2825082	58
1742605	13	1742977	55	1987223	28	2825083	59
1742614	10	1742979	55	1987224	28		
1742657	61	1742981	59	1987225	28		

---

**Engineering Notes**

---



---

**Engineering Notes**

---



---

**Engineering Notes**

---

A large, empty grid area for writing engineering notes, consisting of a uniform pattern of small squares.

## LET'S CONNECT

We make it easy to connect with our experts and are ready to provide all the support you need. Just call your local support number or visit [www.te.com/appliances](http://www.te.com/appliances) to chat with a Product Information Specialist.

## TECHNICAL SUPPORT

[te.com/support-center](http://te.com/support-center)

Australia .....	+86 400-820-6015	Hungary .....	+36 1-2892040	Portugal .....	+34 91-6630420
Austria .....	+43 1-9056-0	India .....	+86 400-820-6015	Russia .....	+74 95-790-2200
Belgium .....	+31 73-6246999	Ireland .....	+1 800-882-391	Slovakia .....	+42 02-720-11102
Brazil .....	+55 11-2103-6000	Italy .....	+39 011-4012111	Slovenia .....	+38 615-602-132
China .....	+86 400-820-6015	Japan .....	+044-844-8052	South Africa .....	+97 150-457-0806
Czech Republic .....	+42 02-7201-1103	Korea .....	+02-3415-4607	Spain .....	+34 932-910-330
Denmark .....	+46 8-5072-5000	Latvia .....	+37 2-6778-673	Sweden .....	+46 8-5072-5000
Estonia .....	+37 2677-8673	Lithuania .....	+37 037426900	Switzerland .....	+41 71-447-0447
Finland .....	+46 8-5072-5000	Luxembourg .....	+31 73-6246999	Taiwan .....	+86 400-820-6015
France .....	+33 1-34-20-8686	Netherlands .....	+31 73-6246999	Turkey .....	+90 212-282-6053
Germany .....	+49 6151-607-1999	New Zealand .....	+86 400-820-6015	United Kingdom .....	+44 800-267666
Greece .....	+97 1-4-347-0226	Norway .....	+46 8-5072-5000	USA .....	800-522-6752
Holland .....	+31 73-6246999	Poland .....	+48 22-4576750		

## te.com

TE Connectivity, TE Connectivity (logo), Every Connection Counts, AMP, AMP-O-LECTRIC, AMPLIVAR, AMPOMATOR, CERTI-LOK, DYNA-CRIMP, FASTIN-FASTON, FASTON, MAG-MATE and SIAMEZE are trademarks. All other logos, products and/or company names referred to herein might be trademarks of their respective owners.

The information given herein, including drawings, illustrations and schematics which are intended for illustration purposes only, is believed to be reliable. However, TE Connectivity makes no warranties as to its accuracy or completeness and disclaims any liability in connection with its use. TE Connectivity's obligations shall only be as set forth in TE Connectivity's Standard Terms and Conditions of Sale for this product and in no case will TE Connectivity be liable for any incidental, indirect or consequential damages arising out of the sale, resale, use or misuse of the product. Users of TE Connectivity products should make their own evaluation to determine the suitability of each such product for the specific application.

© 2016 TE Connectivity Ltd. family of companies All Rights Reserved.

82221 06/2016 APP

## X-ON Electronics

Largest Supplier of Electrical and Electronic Components

*Click to view similar products for [Terminals](#) category:*

*Click to view products by [TE Connectivity](#) manufacturer:*

Other Similar products are found below :

[HT-13-10](#) [71M-250-32-NB](#) [01-2065-1-0216](#) [00581P0075](#) [M10-10RX](#) [M10BCK](#) [60205-1](#) [604200-1](#) [60598-1-CUT-TAPE](#) [60617-1-C](#) [60873-1](#) [M14-516R/SK](#) [M14-6RSX](#) [M18-10FLX](#) [M18-8FBX](#) [M18-8R/LX](#) [M18BCK](#) [61314-6-C](#) [61-S](#) [61-SN-A](#) [62-NBM-A](#) [63-S](#) [640179-1](#) [640917-2-CUT-TAPE](#) [6501550002](#) [66107-2-C](#) [696683-1](#) [696834-1](#) [696861-1](#) [696931-1](#) [696999-1](#) [M8-516RK](#) [M86700006](#) [MA250DMFMX-A](#) [701-2007](#) [701-2307](#) [701-7761-03](#) [70F-110-32-PB](#) [718-N-A](#) [71M-187-20-NBL](#) [71M-250-32-NBL](#) [72F-187-20-NBL](#) [72M-250-32-NBL](#) [7310](#) [73F-250-32](#) [73F-250-32-NBL](#) [73F-250-32-NL](#) [F14-10C](#) [F-1M](#) [751-250](#)