

TP series

Subminiature washable momentary pushbutton switches



DISTINCTIVE FEATURES

- Process sealed
- Single piece case
- Front and rear sealing
- Wide variety of contact materials
- Same PCB layout as TL, TR and TG subminiature switches



ELECTRICAL SPECIFICATIONS

- Max. current/voltage rating with resistive load :
 - gold plated contacts : 0.4 VA 20 V max. AC or DC
 - silver plated contacts : 0.5 A 48 V max. AC or DC
- Minimum load : 10 mA 50 mV - 10 μ A 5 VDC
- Contact resistance : 50 m Ω max.
- Insulation resistance : 1,000 M Ω min. at 500 VDC
- Dielectric strength :
 - 1,000 Vrms 50 Hz min. between terminals and frame
 - 500 Vrms 50 Hz min. between terminals
- Electrical life at full load :
 - gold plated contacts : 60,000 cycles
 - silver plated contacts : 20,000 cycles



ENVIRONMENTAL SPECIFICATIONS

- Operating temperature : -30 °C to +85 °C (-22 °F to +185 °F)
- Moisture : 21 days 95 % (NFC 20-603 - IEC 68-2-3)



GENERAL SPECIFICATIONS

- Total travel :
 - function 2 : 1 mm (.039)
 - function 3 : 0.8 mm (.031)
- Strength of terminals : pull-out force - 10 N max.
- Cleaning : solvents or water + detergent
- Wave soldering : 260 °C (500 °F) - 5 sec.

The company reserves the right to change specifications without notice.



TP series

Subminiature washable momentary pushbutton switches



MATERIALS

- Case : PBT
- Actuator : polyamide, glass filled
- Contacts and terminals :
 - 0 : brass, gold plated
 - 1 : brass, silver plated
 - 3 : brass, gold plated (1.27 micron gold)
 - 8 : contact brass, gold plated + tin plated terminals
 - 9 : contact brass, gold plated (1.27 micron gold) + tin plated terminals
- Terminal seal : epoxy

APEM products may be recycled at end-of-life for the re-claiming of valuable metal components.



TERMINALS

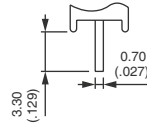

ELECTRICAL FUNCTIONS

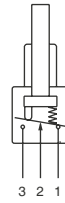

Function 2
(ON - MOM)

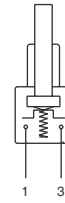

Function 3 (NO)
(OFF - MOM)



PCB MOUNTING

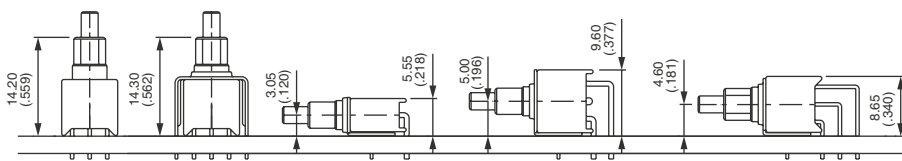



BUILD YOUR PART NUMBER

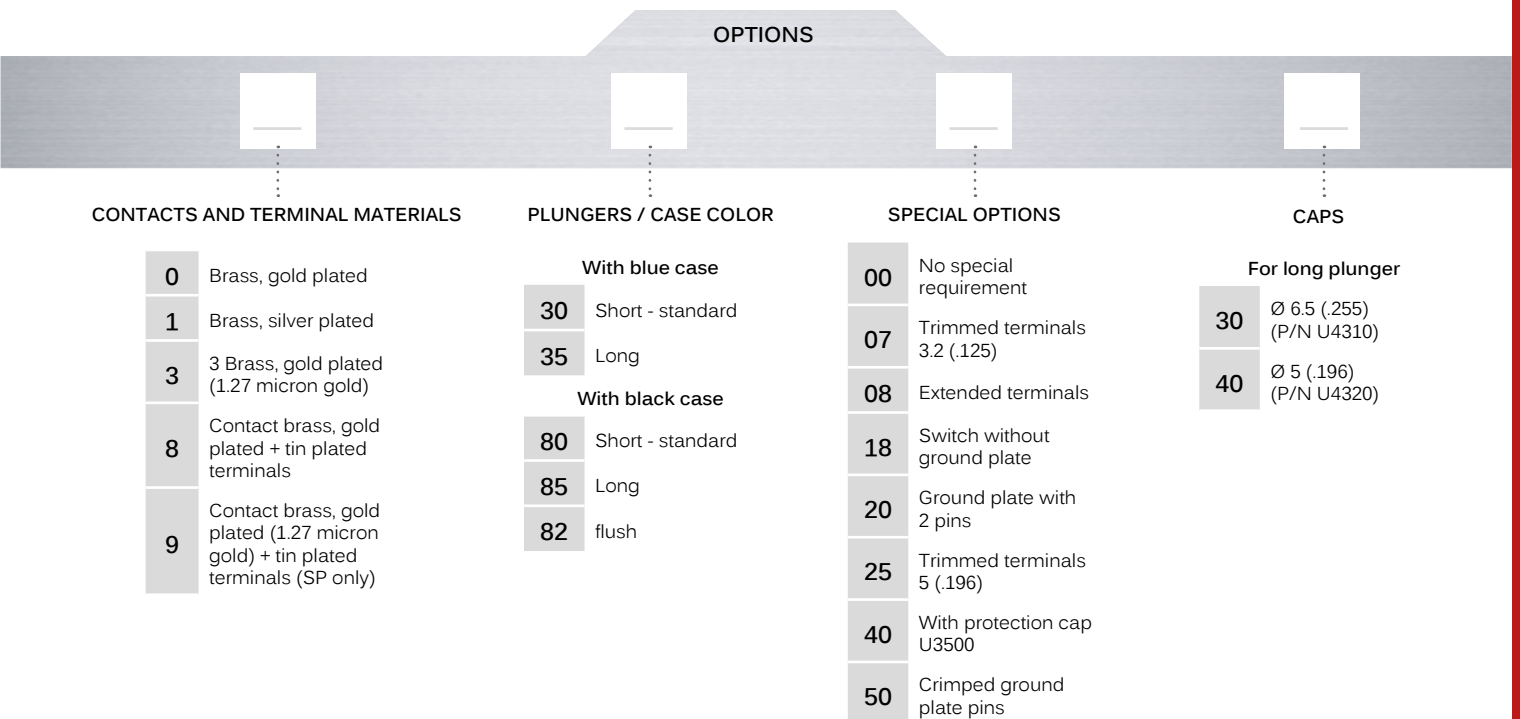
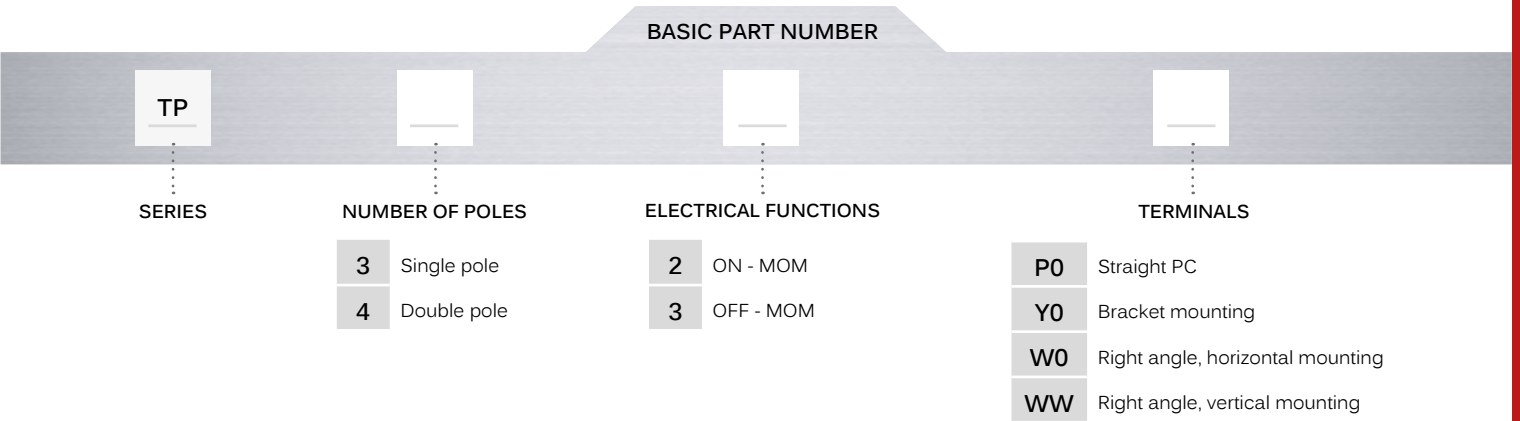

ABOUT THIS SERIES

On the following pages, you will find successively basic part numbers of switches and options in the same order as in above chart.



Notice : please note that not all combinations of above numbers are available. Refer to the following pages for further information.

TP series

Subminiature washable momentary pushbutton switches

STRAIGHT PC TERMINALS : TP..PO





Single pole	Double pole		
TP32PO	TP42PO	ON	MOM
TP33PO	TP43PO	OFF	MOM

Function 3 has two terminals only (3 and 1) per pole

STRAIGHT TERMINALS BRACKET MOUNTING : TP..YO





Single pole	Double pole		
TP32YO	TP42YO	ON	MOM
TP33YO	TP43YO	OFF	MOM

Function 3 has two terminals only (3 and 1) per pole

RIGHT ANGLE TERMINALS HORIZONTAL MOUNTING : TP..W0





Single pole	Double pole		
TP32W0	TP42W0	ON	MOM
TP33W0	TP43W0	OFF	MOM

Function 3 has two terminals only (3 and 1) per pole

RIGHT ANGLE TERMINALS VERTICAL MOUNTING : TP..WW



Single pole	Double pole		
TP32WW	TP42WW	ON	MOM
TP33WW	TP43WW	OFF	MOM

Function 3 has two terminals only (3 and 1) per pole

Shown in function 2, with standard plunger

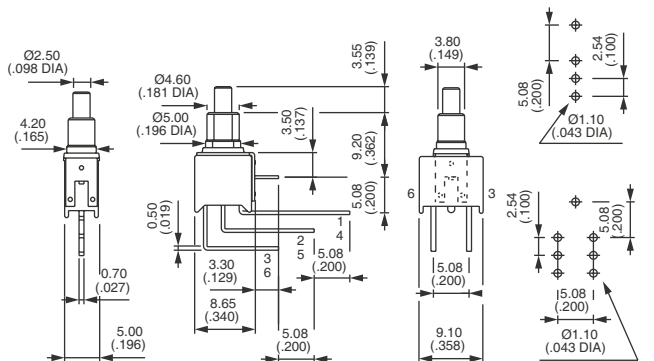
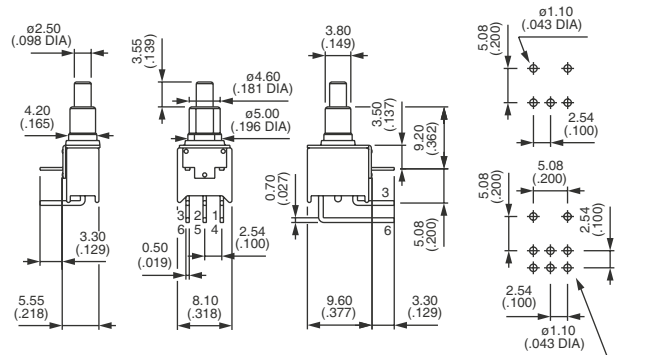
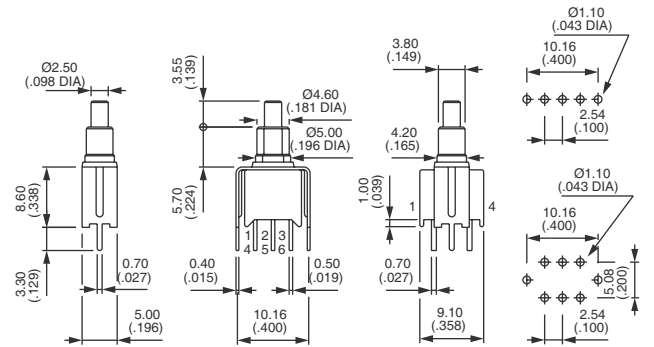
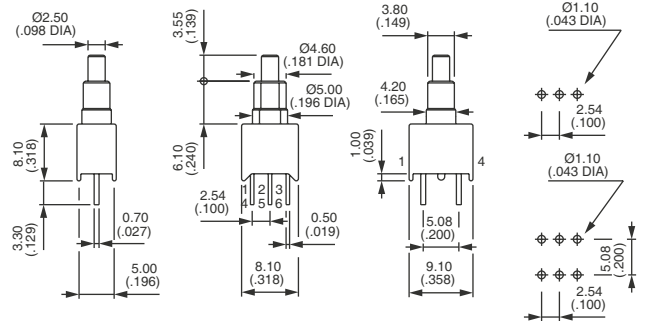

TP series

Subminiature washable momentary pushbutton switches

CONTACT AND TERMINAL MATERIALS

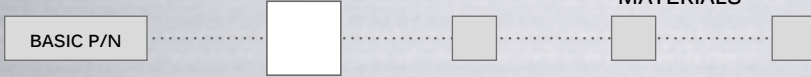

- 0 Brass, gold plated
- 1 Brass, silver plated
- 3 Brass, gold plated (1.27 micron gold)
- 8 Contact brass, gold plated + tin plated terminals
- 9 Contact brass, gold plated (1.27 micron gold) + tin plated terminals (single pole only)

PLUNGERS



Standard plunger color is black.

- 30 Short - standard - with blue case
- 80 Short - standard - with black case
- 35 Long with blue case
- 85 Long with black case
- 82 Flush with black case

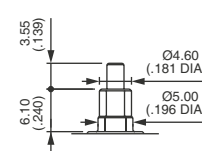
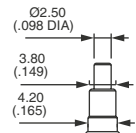

Short - standard

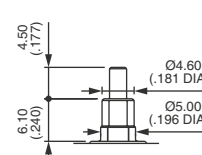
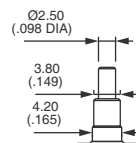

Long

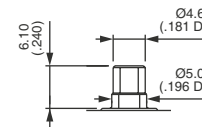
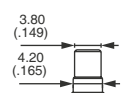

Flush

SPECIAL OPTIONS



- 00 No special requirement
- 07 **Trimmed terminals** - length 3.2 mm (.125) for TP..WW models only
- 08 **Extended terminals** for TP..W0 models only
- 18 Switch **without ground plate** for TP..WW models only
- 20 **Ground plate with 2 pins** for TP..WW models only
- 25 **Trimmed terminals** - length 5 mm (.196) for all models, except TP..WW

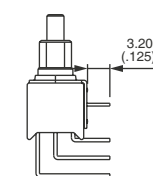

07

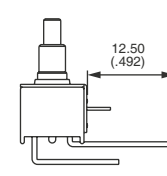

08

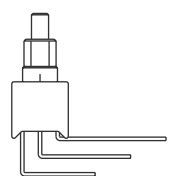

18

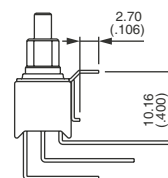

20

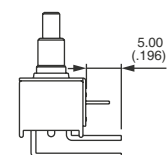

25

TP series

Subminiature washable momentary pushbutton switches

SPECIAL OPTIONS (CONTINUED)

BASIC P/N

- 40 With cap U3500 mounted over plunger and bushing. Further protects the switch during PCB processing
- 50 **Crimping of ground plate pins.** Retains switch on PC during handling and wave soldering. For models TP..W0, TP..WW and TP..Y0 single and double pole.

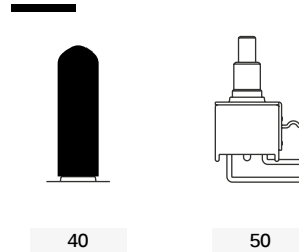

40

50

CAPS

BASIC P/N

- Blank** Without cap
- 30 P/N U4310 - for long plunger only
- 40 P/N U4320 - for long plunger only

To order caps separately, use their part number (U...).

For cap colors, replace "0" by number :

- 1 Blue
- 1/4 Dark blue
- 2 Black
- 3 Green
- 4 Grey
- 5 Yellow
- 6 Red
- 7 Ivory
- 7/1 White
- 9 Orange

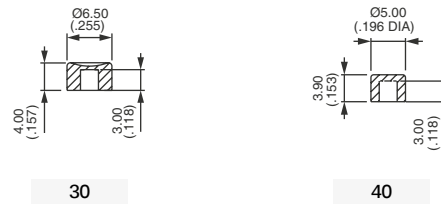

30

40

CAPS FOR PCB PROCESSING

Order separately

Provide additional protection during PCB processing. Supplied separately. For cap mounted on the switch, see special option 40.

Material : vinyl

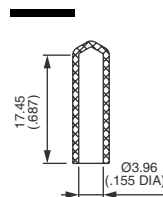

U3502

X-ON Electronics

Largest Supplier of Electrical and Electronic Components

Click to view similar products for [Pushbutton Switches](#) category:

Click to view products by [Apem](#) manufacturer:

Other Similar products are found below :

[LW1L-M1C10V-A](#) [LW2L-A1C20M-GD](#) [LW2L-M1C20M-A](#) [60324L](#) [M7E-HRN2](#) [67021K512](#) [67081K512X](#) [701PB580](#) [719-5504-000](#)
[MDPSSGLFS](#) [810KSV30B](#) [FLT 2U EE 01A](#) [MML21KA3ABK](#) [MML23KA3AC05K-001](#) [MML23KW3AA01W](#) [8418K2](#) [8646AB6X718UL](#)
[8646ABUL](#) [FSDWH](#) [9001KXRK](#) [9001T8BK](#) [9533CD4+U574+U4922](#) [1203MRA](#) [A22EM01S](#) [A595](#) [1202A6](#) [12037A2ULCSA](#) [1203A2UL](#)
[ABD122N-B](#) [1211390004](#) [ABN111-Y](#) [ABN400-R](#) [1211500044](#) [1211580012](#) [1212MRA](#) [1232A6NF](#) [RA3CSH6A](#) [1241.1183.7047](#)
[1241.2511](#) [1241.3428](#) [1223A2ULCSA](#) [1223MRA](#) [1232AX2119](#) [1241.1183.8000](#) [1241.1183.8029](#) [1241.2506](#) [1241.2606](#) [12MA6](#)
[1301940184](#) [RELBARF6X10\(PLASTIC\)](#)