

Factory Installed Panel Mount BOURNS®

TRIMPOT® POTENTIOMETER PANEL MOUNTING OPTIONS AND HARDWARE

Many Trimpot® Potentiometers are available for panel mount application.

This product option provides for maximum design flexibility.

To order Trimpot® Potentiometers with panel mount hardware attached by the factory, simply add an "M" or "Z" suffix to the Bourns part number per Table I.

Example:
3006P-1-100Z

To order military Trimpot® Potentiometers with panel mount hardware attached by the factory, order the military part number and add "with panel mount attached."

Example:
RT12C2PRC, with panel mount attached.

To order panel mounting accessories for customer installation, simply use the part number per Table II.

Example:
H83P

NOTE: For complete product specifications, see data sheet for the trimmer model.

Torque - Apply maximum 8 in. lbs. on mounting nut when mounted on panel.

Models RT12/RJ12, 3057/3059

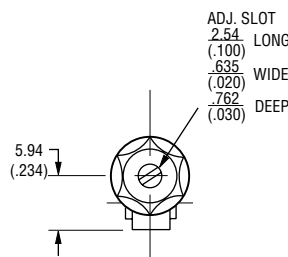
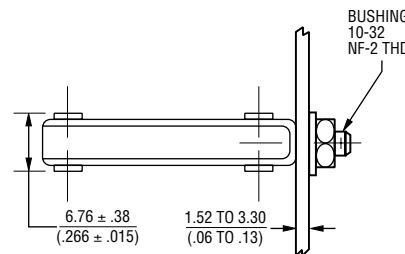
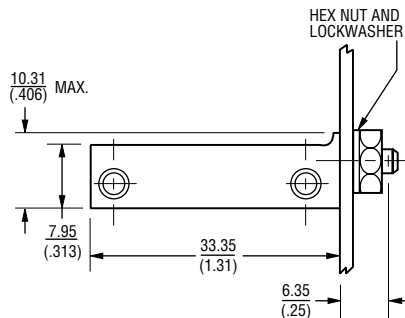

- Notes:
1. Provided with lockwasher and mounting nut.
 2. Recommended panel holes. #10 drill
 $\frac{.194}{(.008)}$

Models 3005/3006/3009

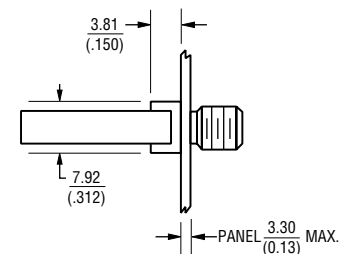
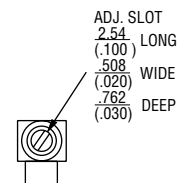
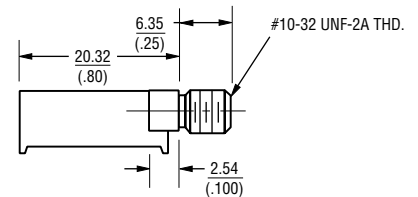

- Notes:
1. Provided with lockwasher and mounting nut.
 2. Recommended panel holes. #7 drill
 $\frac{.200}{(.008)}$

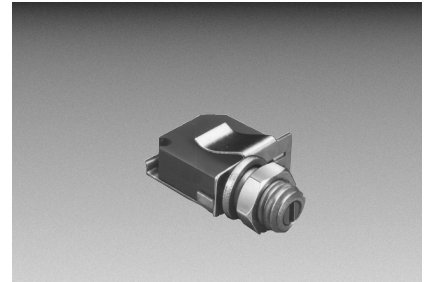
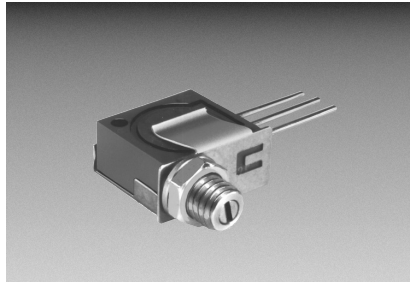
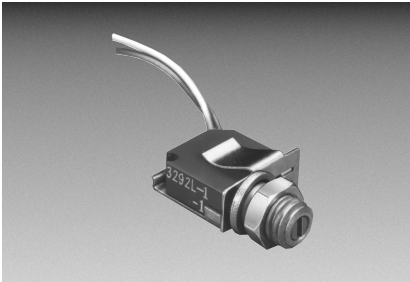

Factory Installed Panel Mount **BOURNS®**

3292

RT22/RTR22/RJ22 3250/3252

RT24/RTR24/3290

X, L and W Styles

**H and W Styles - 3290
X & W Styles-RT24/RTR24**

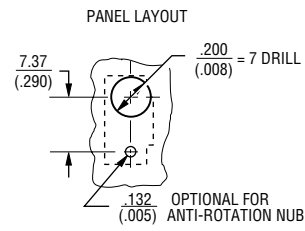
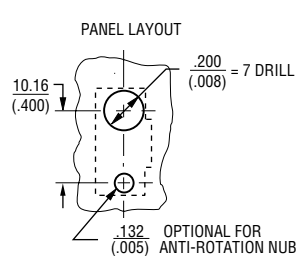
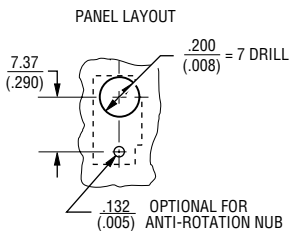
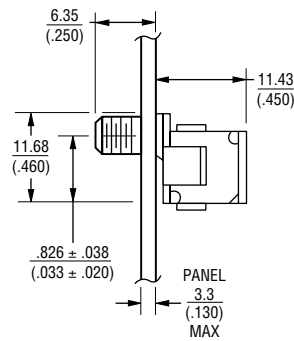
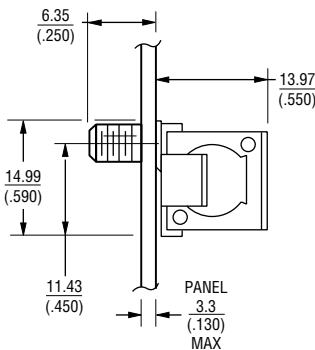
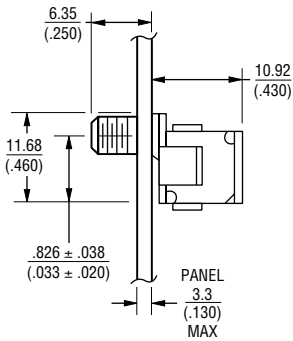
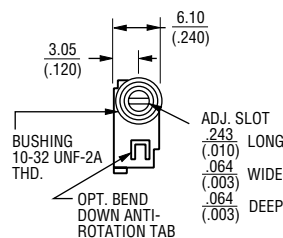
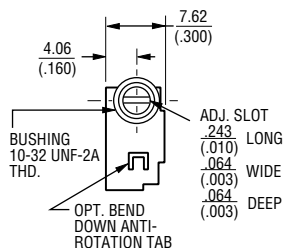
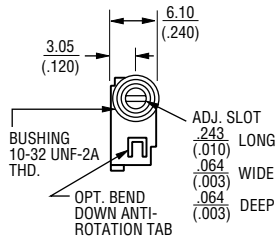

Notes:
1. Provided with lockwasher and mounting nut.

Notes:
1. Provided with lockwasher and mounting nut.

Notes:
1. Provided with lockwasher and mounting nut.

Specifications are subject to change without notice. Users should verify actual device performance in their specific applications. The products described herein and this document are subject to specific disclaimers as set forth on the last page of this document, and at www.bourns.com/legal/disclaimer.pdf.

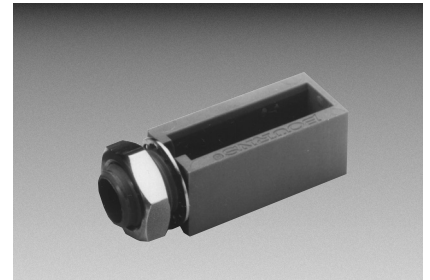
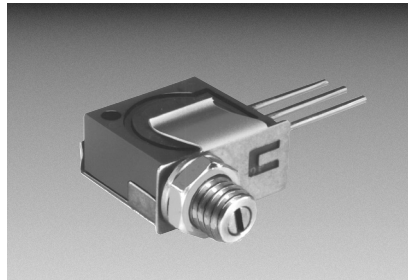
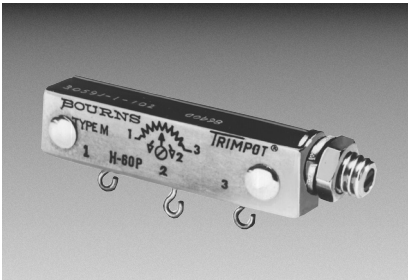

Customer Installed Panel Mount - Unsealed

BOURNS®

SEE TABLE II FOR PANEL MOUNT PART NUMBER

H-58P Panel Mount

1-1/4 Inch Rectangular Multiturn Modules

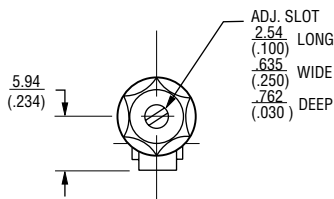
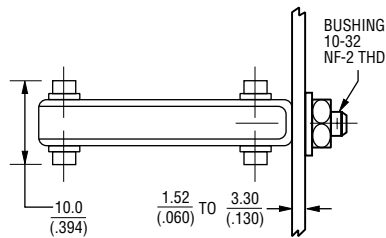
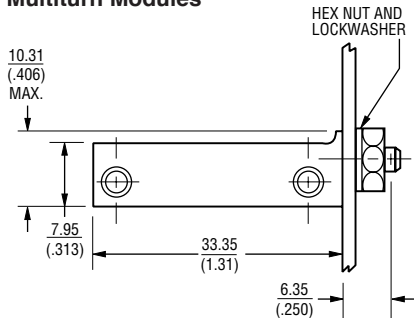

Notes:

1. Provided with lockwasher and mounting nut.
2. Recommended panel holes. #10 drill $\frac{.194}{(.008)}$

*Specify H82 if panel seal is required.

H-65P Panel Mount

1/2 Inch Square Multiturn Models

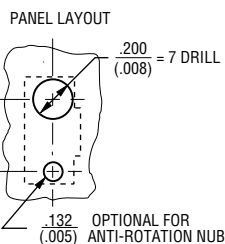
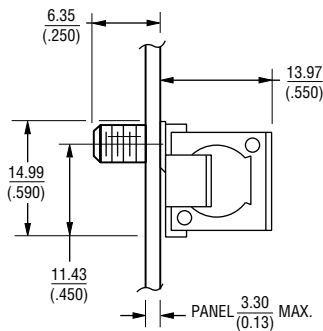
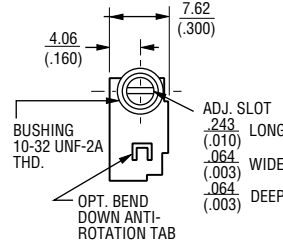

Notes:

1. Provided with lockwasher and mounting nut.
2. Drawings shown with trimmer. Order part separately.

H-83P Panel Mount

Adapter for Models 3005 and 3006

The H-83P Adapter is used with Models 3005 and 3006. Order separately and simply snap fit the trimmer in the plastic case. The H-83P with lockwasher and mounting nut is available in 50-piece lots.

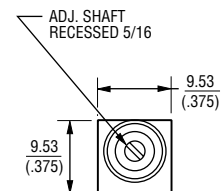
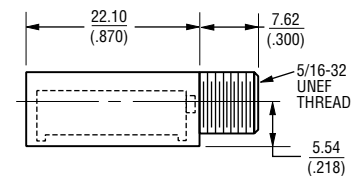

Notes:

1. Drawings shown with trimmer. Order part separately.

Specifications are subject to change without notice.

Users should verify actual device performance in their specific applications.

The products described herein and this document are subject to specific disclaimers as set forth on the last page of this document, and at www.bourns.com/legal/disclaimer.pdf.

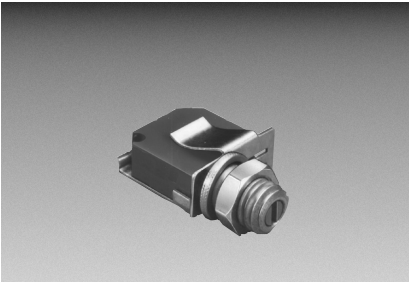

Customer Installed Panel Mount **BOURNS®**

H-114P/115P/116P Panel Mount

3/8 Inch Square Multiturn Models

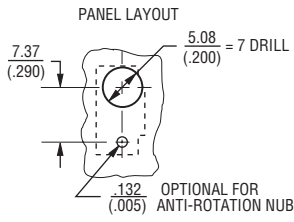
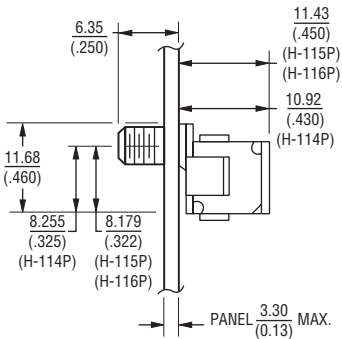
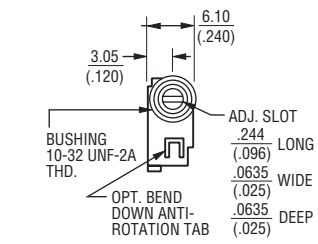

- Notes:
1. Provided with lockwasher and mounting nut.
 2. Drawings shown with trimmer. Order part separately.

H-117P Panel Mount

3/8 Inch Square Multiturn Models

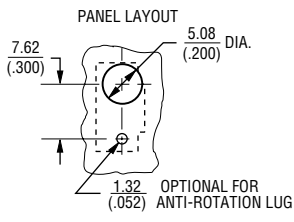
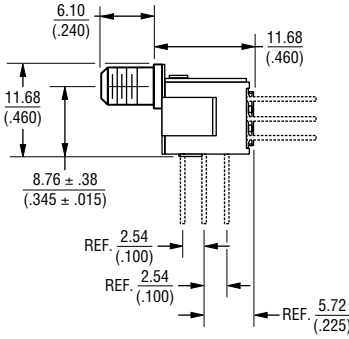
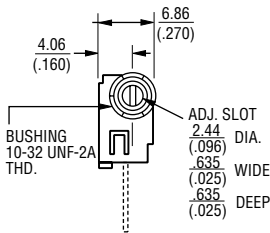

- Notes:
1. Provided with lockwasher and mounting nut.
 2. Drawings shown with trimmer. Order part separately.

TABLE I
FACTORY INSTALLED
PANEL MOUNTS

STANDARD P/N	P/N WITH PANEL MOUNT
3005P-1-(RC)	3005P-1-(RC) Z
3006P,Y, or W-1-(RC)	3006P,Y, or W-1-(RC) Z
3009P or Y-1-(RC)	3009P or Y-1-(RC) Z
3057L,J,P, or Y-1-(RC)	3057L,J,P, or Y-1-(RC) M
3059L,J,P, or Y-1-(RC)	3059L,J,P, or Y-1-(RC) M
3250L or W-1-(RC)	3250L or W-1-(RC) M
3252L or W-1-(RC)	3252L or W-1-(RC) M
3290 H or W-1-(RC)	3290H or W-1-(RC) M
3292L,W, or X-1-(RC)	3292L,W, or X-1-(RC) M
3296W or X-1-(RC)	3296W or X-1-(RC) M

TABLE II
RETRO-FIT PANEL MOUNTS FOR
INSTALLATION BY CUSTOMER

STANDARD P/N	ORDER PANEL MOUNT P/N
3005P-1-(RC)	H-83P
3006P,Y, or W-1-(RC)	H-83P
3057L,J,P, or Y-1-(RC)	H-58P* SCREW ASSY.
3059L,J,P, or Y-1-(RC)	H-58P* SCREW ASSY.
3250L, W, X-(RC)	H-65P-1*
3252L or W-1-(RC)	H-65P-3*
3252X-1-(RC)	H-65P-5*
3290 H or W-1-(RC)	H-114P*
3292L-1-(RC)	H-115P*
3292W OR X-1-(RC)	H-116P*
RT12P,Y,L	H-58P* SCREW ASSY.
RJ12P,Y	H-58P* SCREW ASSY.
RT22L,W, X, RTR22L,W, X	H-65P-1*
RJ22L,W	H-65P-3*
RJ22X	H-65P-5*
RT24W / RTR24W OR X	H-114P*
RJR24W OR X	H-117P*

*Specify H-82 if panel seal is required.

Specifications are subject to change without notice. Users should verify actual device performance in their specific applications. The products described herein and this document are subject to specific disclaimers as set forth on the last page of this document, and at www.bourns.com/legal/disclaimer.pdf.

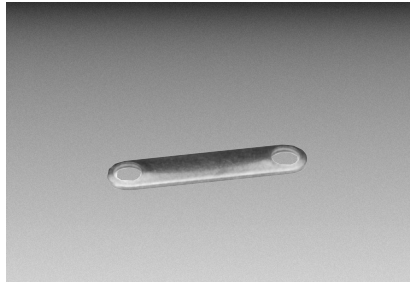
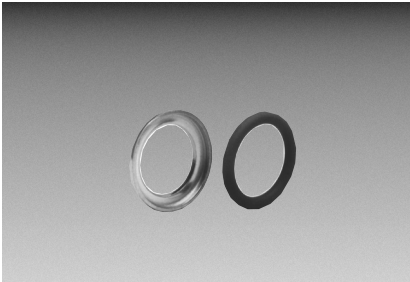

Hardware For Special Mounting Applications **BOURNS®**

H-82 Panel Seal

For all panel mounts with size 10-32 bushings.

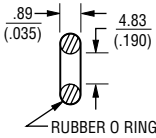
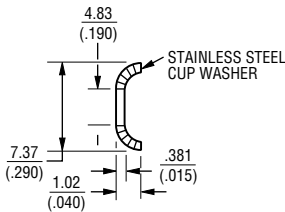

To be used with the following to provide panel seal:

- H-58P
- H-65P-1
- H-65P-3
- H-65P-5
- H-114P
- H-115P
- H-116P
- H-117P

H-25/H-28 Stacking Straps

Models 3250, 3252 (H-25) and 3292 (H-28).

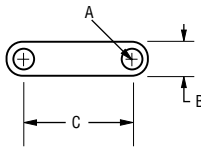

DIMENSIONS	H-25	H-28
A	.236 (.093)	.178 (.070)
B	.363 (.143)	.318 (.125)
C	1.321 (.520)	1.064 (.419)
THICKNESS	.51 (.02)	

This legal disclaimer applies to purchasers and users of Bourns® products manufactured by or on behalf of Bourns, Inc. and its affiliates (collectively, “Bourns”).

Unless otherwise expressly indicated in writing, Bourns® products and data sheets relating thereto are subject to change without notice. Users should check for and obtain the latest relevant information before placing orders and should verify that such information is current and complete.

The characteristics and parameters of a Bourns® product set forth in its data sheet are based on laboratory conditions, and statements regarding the suitability of products for certain types of applications are based on Bourns’ knowledge of typical requirements in generic applications. The characteristics and parameters of a Bourns® product in a user application may vary from the data sheet characteristics and parameters due to a combination of the Bourns® product with other components in the user’s application or due to the environment of the user application itself. Such characteristics and parameters also can and do vary in different applications and actual performance may vary over time. Users should always verify actual performance of the Bourns® product in their specific devices and applications, and make their own independent judgments about how much additional test margin to design in to compensate for differences between laboratory and real world conditions.

Unless Bourns has explicitly designated an individual Bourns® product as meeting the requirements of a particular industry standard (e.g., ISO/TS 16949) or a particular qualification (e.g., UL listed or recognized), Bourns is not responsible for any failure of an individual Bourns® product to meet requirements of such industry standard or such particular qualification. Users of Bourns® products are responsible for ensuring compliance with safety-related requirements and standards applicable to their applications.

Bourns® products are not recommended, authorized or intended for use in nuclear, lifesaving, life-critical or life-sustaining applications, nor in any other applications where failure or malfunction may result in personal injury, death, or severe property or environmental damage. Unless expressly and specifically approved in writing by two authorized Bourns representatives on a case-by-case basis, use of any Bourns® products in such unauthorized applications is at the user’s sole risk. Life-critical applications include devices identified by the U.S. Food and Drug Administration as Class III devices and generally equivalent classifications outside of the United States.

Bourns® standard products that are designed and tested for use in automotive applications will be described on the applicable data sheets as compliant with the applicable AEC-Q standard. Unless expressly and specifically approved in writing by two authorized Bourns representatives on a case-by-case basis, use of any other Bourns® standard products in an automotive application is not recommended, authorized or intended and will be at the user’s sole risk.

Bourns® standard products are not tested to comply with United States Federal Aviation Administration standards generally or any other generally equivalent governmental organization standard applicable to products designed or manufactured for use in aircraft or space applications. Bourns® standard products that are designed and tested for use in aircraft or space applications will be described on the applicable data sheets as compliant with the RTCA DO-160 standard. Unless expressly and specifically approved in writing by two authorized Bourns representatives on a case-by-case basis, use of any other Bourns® standard product in an aircraft or space application is not recommended, authorized or intended and will be at the user’s sole risk.

The use and level of testing applicable to Bourns® custom products shall be negotiated on a case-by-case basis by Bourns and the user for which such Bourns® custom products are specially designed. Absent a written agreement between Bourns and the user regarding the use and level of such testing, the provisions above applicable to Bourns® standard products shall also apply to such Bourns® custom products.

Users shall not sell, transfer, export or re-export any Bourns® products or technology for use in activities which involve the design, development, production, use or stockpiling of nuclear, chemical or biological weapons or missiles, nor shall they use Bourns® products or technology in any facility which engages in activities relating to such devices. The foregoing restrictions apply to all uses and applications that violate national or international prohibitions, including embargos or international regulations. Further, Bourns® products, technology or technical data may not under any circumstance be exported or re-exported to countries subject to international sanctions or embargoes, and Bourns® products may not, without prior authorization from Bourns and/or the U.S. Government, be resold, transferred, or re-exported to any party not eligible to receive U.S. commodities, software, and technical data.

To the maximum extent permitted by applicable law, Bourns disclaims (i) any and all liability arising out of the application or use of any Bourns® standard product, (ii) any and all liability, including, without limitation, special, punitive, consequential or incidental damages, and (iii) any and all implied warranties, including implied warranties of fitness for particular purpose, non-infringement and merchantability.

For your convenience, copies of this Legal Disclaimer Notice with German, Spanish, Japanese, Traditional Chinese and Simplified Chinese bilingual versions are available at:

Web Page: <http://www.bourns.com/legal/disclaimers-terms-and-policies>

PDF: <http://www.bourns.com/docs/Legal/disclaimer.pdf>

X-ON Electronics

Largest Supplier of Electrical and Electronic Components

Click to view similar products for [Potentiometer Tools & Hardware](#) category:

Click to view products by [Bourns](#) manufacturer:

Other Similar products are found below :

[006-1-1](#) [006-1-2](#) [7071](#) [7071E](#) [7072E](#) [FKS-1/4](#) [A-0709-H](#) [A-0709-K](#) [H-38-15](#) [H-38-3](#) [1220A](#) [ACCPOTECB303651550](#) [H-858](#) [H-37-5](#) [H-38-1](#) [7074E](#) [RK14K1240A4S](#) [HARDWARE](#) [ACCTRIADB30603](#) [ACCTRIADB30602](#) [ACCTR514-4002](#) [ACCTR512-0022](#) [H-37-4](#) [H-38-9](#) [H-862](#) [006-1-0](#) [H-38-2](#) [H-37-1](#) [ACCTRITOB308-T000](#) [ACCPOTECB303653230](#) [6533](#) [008T000](#) [H-117P](#) [H-1202-1](#) [H-1202-2](#) [H-127](#) [H-37-2](#) [H-38-11](#) [H-58P](#) [H-83P](#) [H-852](#) [H-853](#) [H-857](#) [H-90](#) [H-91](#) [H-92-1](#) [45T3](#) [H-82](#) [RS-2](#) [6532E](#) [6533E](#)