

**Miniature Relay PCL**

- Small size, 3A, 5A switching capacity
- Meets UL and CSA requirements
- 2 pole and 4 pole contact arrangements
- AC and DC coils with UL Class F (155°C) coil insulation system standard
- Optional flange mount case
- Plug-in terminals or PCB terminals

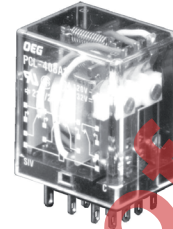

Typical applications  
Factory automation, process controls, electrical panels, etc.



**Approvals**

UL E58304, TUV R50138495, CSA 1017162(LR48471-207),  
CQC CQC08001025963

Technical data of approved types on request

**Contact Data**

	2 pole	4 pole
Contact arrangement	2 form A (2NO) 2 form C (2CO)	4 form A (4NO) 4 form C (4CO)
Rated voltage	250VAC, 24VDC	
Rated current	5A	3A
Switching power	1100VA, 120W	660VA, 72W
Contact material	Ag, Ag <sub>2</sub> ShO <sub>2</sub> , AgCdO	
Min. recommended contact load	100mA at 5VDC	
Initial contact resistance	50mΩ at 6VDC, 1A	
Frequency of operation with/without load	30/300min <sup>-1</sup>	
Operate/release time max.		
AC coil	20/20ms	
DC coil	15/8ms	
Electrical endurance	100x10 <sup>3</sup> ops. at rated load	
Contact ratings	5A at 250VAC/24VDC resistive 3A at 250VAC/24VDC resistive	
Mechanical endurance	100x10 <sup>6</sup> ops.	

**Coil Data**

Coil voltage range	6 to 110VDC 6 to 240VAC (50/60Hz)
Max. coil power	110% of rated power
Max. coil temperature	
AC coil	115°C
DC coil	105°C
Coil insulation system according UL	class F

**Coil versions, DC coil**

Coil code	Rated voltage VDC	Operate voltage VDC	Release voltage VDC	Coil resistance Ω±10 %	Rated coil power mW
01D	6	4.8	0.6	40	900
02D	12	9.6	1.2	160	900
03D	24	19.2	2.4	650	900
04D	48	38.4	4.8	2600	900
05D	100/110	88.0	10.0	11000	1100

All figures are given for coil without pre-energization, at ambient temperature +23°C

**Coil versions, AC coil**

Coil code	Rated voltage VAC	Operate voltage VAC	Release voltage VAC	Coil resistance Ω±10%	Rated coil power VA
01A	6	4.8	1.8	10	1.4
02A	12	9.6	3.6	40	1.4
03A	24	19.2	7.2	160	1.4
04A	48	38.4	14.4	600	1.4
05A	100	80.0	30.0	2800	1.4
06A	110/120	96.0	33.0	3400	1.4
07A	200	160.0	60.0	11000	1.4
08A	220/240	192.0	66.0	13600	1.4

All figures are given for coil without pre-energization, at ambient temperature +23°C, 50 Hz

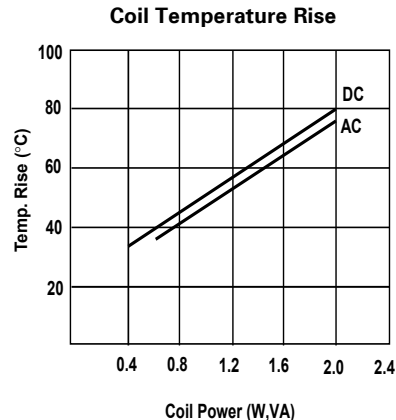
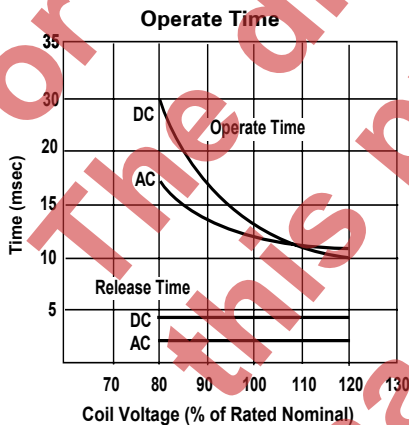

**Miniature Relay PCL (Continued)**

**Insulation Data**

Initial dielectric strength	
between open contacts	1000V <sub>rms</sub>
between contact and coil	2000V <sub>rms</sub>
between adjacent contacts	1500V <sub>rms</sub>
Initial surge withstand voltage	
between contact and coil	3000V(1.2/50μs)
Initial insulation resistance	1000MΩ at 500VDC

**Other Data**

Material compliance: EU RoHS/ELV, China RoHS, REACH, Halogen content refer to the Product Compliance Support Center at [www.te.com/customersupport/rohssupportcenter](http://www.te.com/customersupport/rohssupportcenter)

Ambient temperature	-40 to 55°C
Category of environmental protection	
IEC 61810	RTI - dust protected
Vibration resistance (functional)	10 to 55Hz, 1.0mm double amplitude
Vibration resistance (destructive)	10 to 55Hz, 1.0mm double amplitude
Shock resistance (functional)	10g
Shock resistance (destructive)	100g
Terminal type	plug-in, PCB-THT
Weight	approx. 32g
Packaging/unit	box/25 pcs., carton/500 pcs.

**Accessories**

For details see datasheet [Accessories Miniature Relay PT and accessories list](#)

**Accessories**

Product Code	Description	Part Number
PCL-2F-E,000	2 pole DIN Rail socket with finger protection	1721882-1
PCL-4F-E,000	4 pole DIN Rail socket with finger protection	1721884-1
PCL-2F,000	2 pole DIN Rail socket	1649017-1
PCL-4F,000	4 pole DIN Rail socket	1649019-1

**Terminal assignment**



**PCB layout**

Bottom view on pins

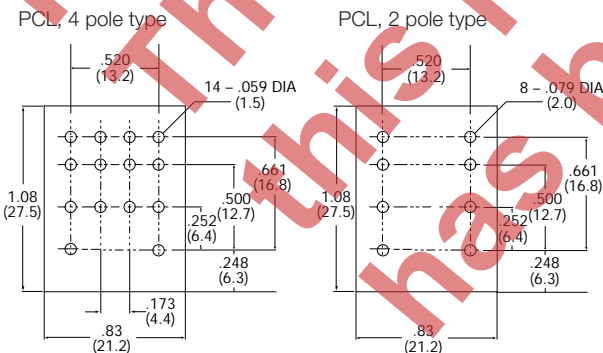

**Miniature Relay PCL** (Continued)

**Dimensions**

PCL, 2 form A or 2 form C, PCB terminals

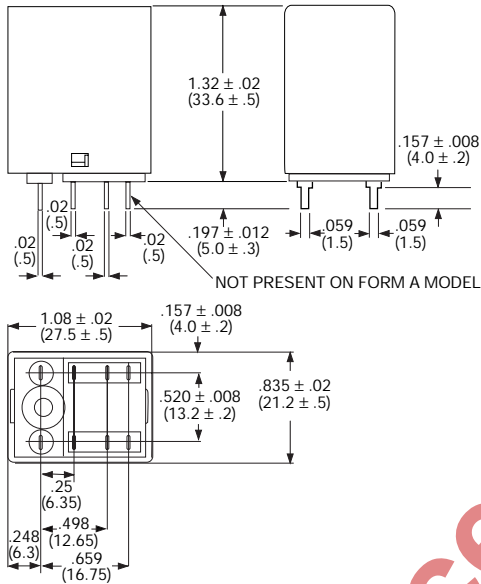

PCL, 2 form A or 2 form C, plug-in terminals

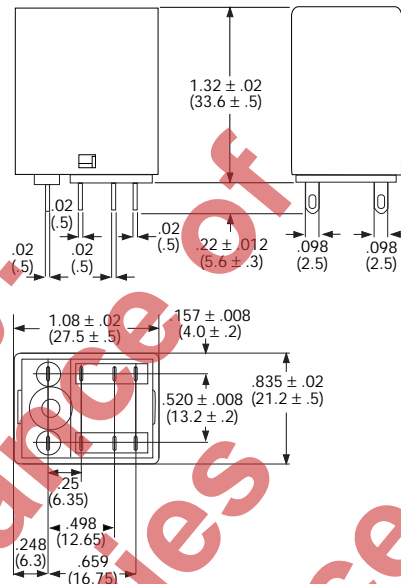

PCL, 4 form A or 4 form C, PCB terminals

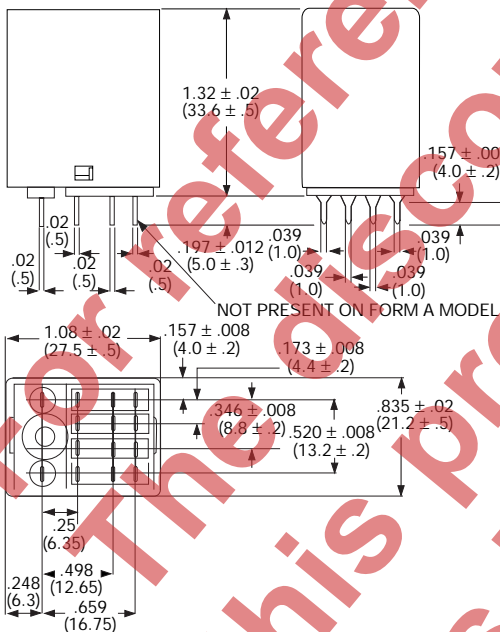

PCL, 4 form A or 4 form C, plug-in terminals

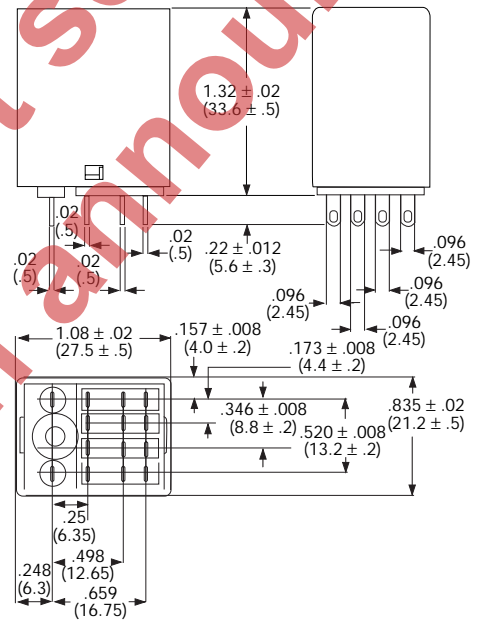

**Miniature Relay PCL** (Continued)

<b>Product code structure</b>	Typical product code		<b>PCL</b>	<b>-2</b>	<b>02A</b>	<b>1</b>		<b>S</b>		<b>,000</b>
<b>Type</b>	<b>PCL</b> Miniature Relay PCL									
<b>Number of poles</b>	<b>2</b> 2 pole		<b>4</b>	4 pole						
<b>Coil voltage</b>	Coil code: please refer to coil versions table									
<b>Contact material</b>	<b>Blank</b> Ag (available on 4 pole model only)		<b>1</b>	AgCdO (available with all versions)						
			<b>2</b>	AgSnO <sub>2</sub> (available on 2 pole model only)						
<b>Contact arrangement</b>	<b>Blank</b> Form C (CO) contact		<b>M</b>	Form A (NO) contact						
<b>Case type</b>	<b>S</b> Standard (smoke color)		<b>F</b>	Flange mount (smoke color)						
<b>Terminal type</b>	<b>Blank</b> Plug-in		<b>P</b>	PCB						
<b>Indicator lamp</b>	<b>Blank</b> None		<b>L</b>	Indicator lamp						
<b>Option</b>	<b>,000</b> Standard model									

Product Code	Arrangement	Cont. material	Terminal	Coil	Coil voltage	Indicator	Part Number
PCL-203D1S,000	2 Form C	AgCdO	Plug-in	DC coil	24VDC	none	1-1419135-7
PCL-203D1SL,000				AC coil	220/240VAC	LED	1461113-6
PCL-208A1S,000						none	1-1419135-8
PCL-208A1SL,000						LED	1461113-8
PCL-403DS,000	4 Form C	Ag		DC coil	24VDC	none	8-1440002-9
PCL-403DSL,000				AC coil	220/240VAC	LED	1461008-6
PCL-408AS,000						none	9-1440002-3
PCL-408ASL,000						LED	1461008-8

For reference only. This product series has been announced.

## X-ON Electronics

Largest Supplier of Electrical and Electronic Components

*Click to view similar products for [General Purpose Relays](#) category:*

*Click to view products by [TE Connectivity](#) manufacturer:*

Other Similar products are found below :

[APF30318](#) [JVN1AF-4.5V-F](#) [PCN-105D3MHZ](#) [5JO-10000S-SIL](#) [5JO-1000CD-SIL](#) [5JO-400CD-SIL](#) [LY2S-AC220/240](#) [LYQ20DC12](#)  
[6031007G](#) [6131406HQ](#) [6-1393099-3](#) [6-1393099-8](#) [6-1393122-4](#) [6-1393123-2](#) [6-1393767-1](#) [6-1393843-7](#) [6-1415012-1](#) [6-1419102-2](#) [6-1423698-4](#) [6-1608051-6](#) [6-1608067-0](#) [6-1616170-6](#) [6-1616248-2](#) [6-1616282-3](#) [6-1616348-2](#) [6-1616350-1](#) [6-1616350-8](#) [6-1616358-7](#) [6-1616359-9](#) [6-1616360-9](#) [6-1616931-6](#) [6-1617039-1](#) [6-1617052-1](#) [6-1617090-2](#) [6-1617090-5](#) [6-1617347-5](#) [6-1617353-3](#) [6-1617801-8](#) [6-1617802-2](#) [6-1618107-9](#) [6-1618248-4](#) [M83536/1-027M](#) [CX-4014](#) [MAHC-5494](#) [MAVCD-5419-6](#) [703XCX-120A](#) [7-1393100-5](#) [7-1393111-7](#)  
[7-1393144-5](#) [7-1393767-8](#)