

# CD Series 8mm DIP Coded Rotary Switches



H

DIP

## Features/Benefits

- **Process sealed – withstands soldering and cleaning**
- **Thru-hole and surface mount models**
- **Compact size saves space – 36% smaller than traditional 10mm DIP**
- **Crisp, positive detent ensures actuation**
- **RoHS compliant**

## Typical Applications

- **Address switching applications**
- **Data storage devices**
- **Computer and peripherals**
- **Instrumentation**



## Specifications

CONTACT RATING: 0.4 VA max. @ 20 V AC or V DC max.

MECHANICAL AND ELECTRICAL LIFE:

CD10 & CD16: 20,000 actuations.

CD08: 12,000 actuations.

CONTACT RESISTANCE: 50 milliohms max. initial.

INSULATION RESISTANCE: 100 megohms min.

@ 250 V AC min.

DIELECTRIC STRENGTH: 250 V RMS min. @ sea level.

OPERATING TEMPERATURE: -25°C to 85°C.

STORAGE TEMPERATURE: -40°C to 85°C.

SOLDERABILITY: Per MIL-STD-202F method 208D or EIA RS-186E, method 9 (1 hour steam aging).

PACKAGING: Switches supplied in rigid tubes in full-tube quantities only: this may affect order quantity. Tube quantity is 60 pieces per tube. Surface mount switches available in tape & reel packaging per EIA 481A, 800 per reel, surface mount with "M0" actuator only.

## Materials

COVER: PPS (UL94V-0), Color; Black.

BASE: PPS (UL94V-0), Color; Black

ACTUATOR: LCP (UL 94V-0), Color White (CDXXR)  
Color Black (CDXXC)

Note: internal o-ring seal standard with all actuators.

MOVABLE CONTACTS: Copper alloy with gold plate over nickel plate.

STATIONARY CONTACTS: Copper alloy with gold plate over nickel plate.

TERMINALS: Copper alloy with gold plate over nickel plate.

**Note:** Specifications and materials listed above are for switches with standard options. For information on specific and custom switches, consult Customer Service Center.

## How To Order

The Build-A Switch concept allows you to mix and match options to create the switch you need. Below is a complete listing of options shown in catalog. To order, simply select desired option from each category and place in the appropriate box.

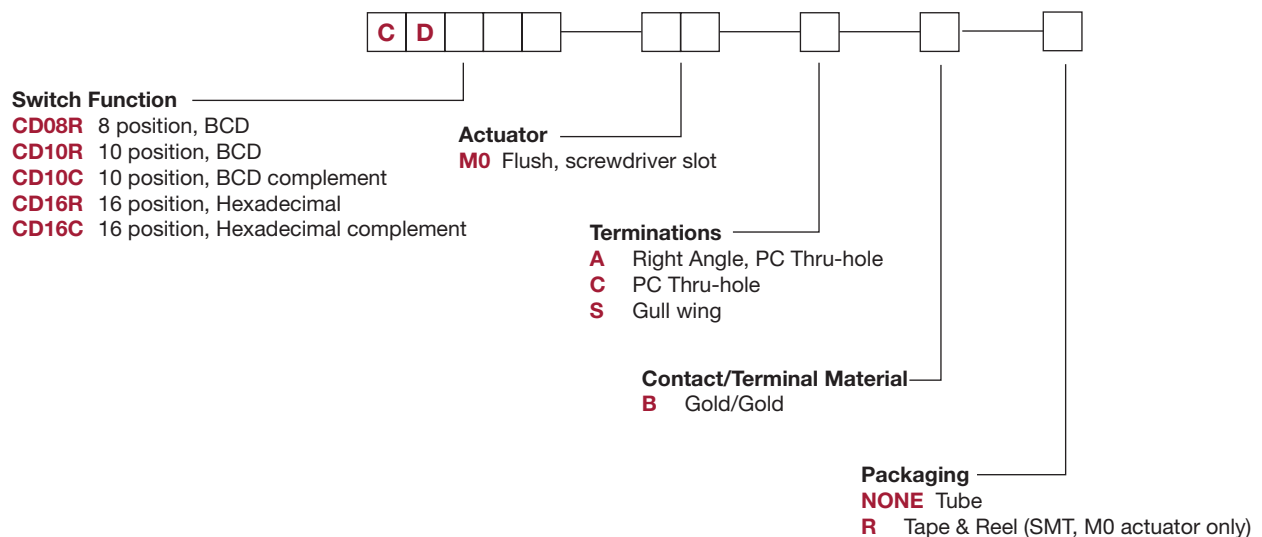

Dimensions are shown: Inch (mm)  
Specifications and dimensions subject to change



# CD Series 8mm DIP Coded Rotary Switches

## SWITCHES WITH STANDARD OPTIONS

### PC Mount



CD16RM0CB

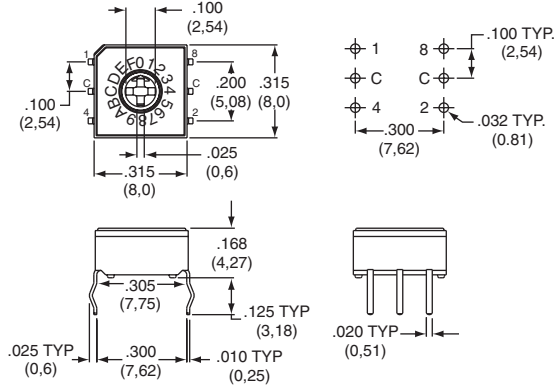

PART NUMBER	NO. POS.	QUANTITY PER TUBE
CD08RM0CB	8	60
CD10RM0CB	10	60
CD10CM0CB	10	60
CD16RM0CB	16	60
CD16CM0CB	16	60

### Right Angle Mount



CD10RM0AB

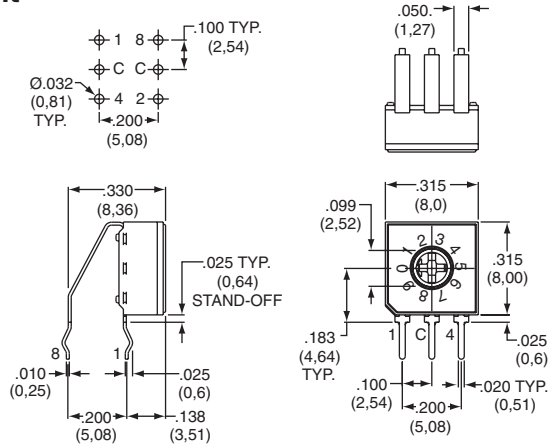

PART NUMBER	NO. POS.	QUANTITY PER TUBE
CD08RM0AB	8	60
CD10RM0AB	10	60
CD10CM0AB	10	60
CD16RM0AB	16	60
CD16CM0AB	16	60

### Surface Mount



CD10RM0SB

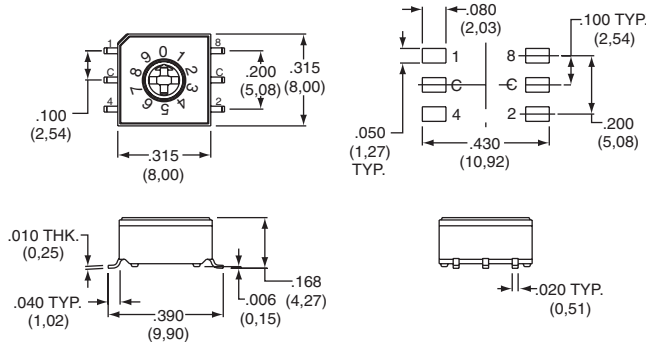

PART NUMBER	NO. POS.	QUANTITY PER TUBE
CD08RM0SB	8	60
CD10RM0SB	10	60
CD10CM0SB	10	60
CD16RM0SB	16	60
CD16CM0SB	16	60

Note: For tape and reel packaging, add 'R' to end of part number.

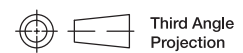

Dimensions are shown: Inch (mm)  
Specifications and dimensions subject to change

# CD Series 8mm DIP Coded Rotary Switches



H

DIP

## SWITCH FUNCTION

**CD08R** 8 POSITION, BCD  
ACTUATOR COLOR: WHITE

POS.	0	1	2	3	4	5	6	7
C	●	●	●	●	●	●	●	●
1		●						
2			●	●			●	●
4					●	●	●	●
8								

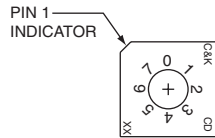

Switches ship and to be solder processed in position "0"

**CD10R** 10 POSITION, BCD  
ACTUATOR COLOR: WHITE

POS.	0	1	2	3	4	5	6	7	8	9
C	●	●	●	●	●	●	●	●	●	●
1		●		●		●		●		●
2			●	●			●	●		
4					●	●	●	●		
8									●	●

Switches ship and to be solder processed in position "0"

**CD10C** 10 POSITION, BCD COMPLEMENT  
ACTUATOR COLOR: BLACK

POS.	0	1	2	3	4	5	6	7	8	9
C	●	●	●	●	●	●	●	●	●	●
1	●		●		●		●		●	
2	●	●			●	●			●	●
4	●				●	●	●	●		●
8	●	●	●	●	●	●	●	●	●	●

Switches ship and to be solder processed in position "7"

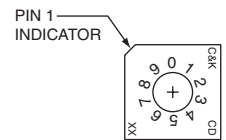

**CD16R** 16 POSITION, HEXADECIMAL  
ACTUATOR COLOR: WHITE

POS.	0	1	2	3	4	5	6	7	8	9	A	B	C	D	E	F
C	●	●	●	●	●	●	●	●	●	●	●	●	●	●	●	●
1		●		●		●		●		●		●		●		●
2			●	●			●	●			●	●			●	●
4					●	●	●	●			●	●	●	●		
8									●	●	●	●	●	●	●	●

Switches ship and to be solder processed in position "0"

**CD16C** 16 POSITION, HEXADECIMAL COMPLEMENT  
ACTUATOR COLOR: BLACK

POS.	0	1	2	3	4	5	6	7	8	9	A	B	C	D	E	F
C	●	●	●	●	●	●	●	●	●	●	●	●	●	●	●	●
1	●		●		●		●		●		●		●		●	
2	●	●			●	●			●	●			●	●		
4	●				●	●	●	●			●	●	●	●		
8	●	●	●	●	●	●	●	●	●	●	●	●	●	●	●	●

Switches ship and to be solder processed in position "F"

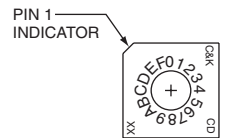

## ACTUATOR

**M0** (STD.) FLUSH WITH SCREWDRIVER SLOT

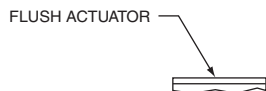
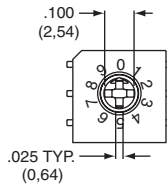

NOTE: Designed for #0 Phillips screwdriver.



Dimensions are shown: Inch (mm)  
Specifications and dimensions subject to change



# CD Series 8mm DIP Coded Rotary Switches

## TERMINATIONS



### C PC, THRU-HOLE

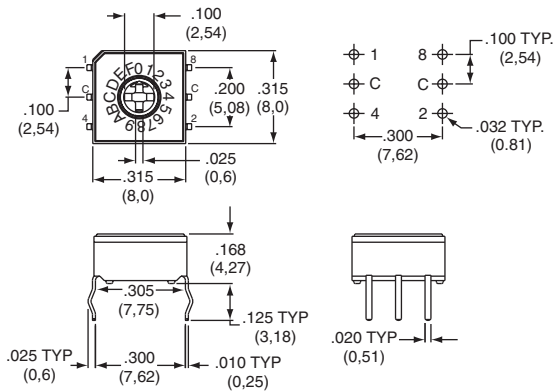

### A RIGHT ANGLE, PC THRU-HOLE

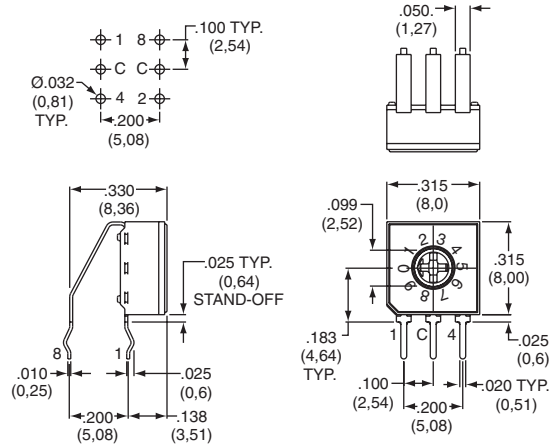

### S SURFACE MOUNT

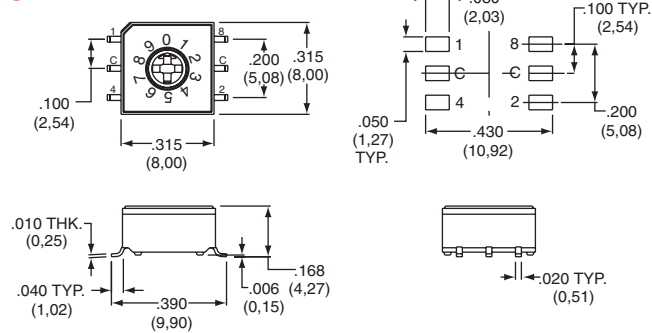

## CONTACT MATERIAL



OPTION CODE	RoHS COMPLIANT*	RoHS COMPATIBLE*	CONTACT MATERIAL	TERMINAL PLATING	RATING	
<b>B</b>	YES	YES	GOLD	GOLD	LOW LEVEL/DRY CIRCUIT	0.4 VC MAX. @ 20 V AC or DC MAX.

\* Note: See Technical Data section of this catalog for RoHS compliant and compatible definitions and specifications.

## TAPE & REEL

For part number CDxxM0SB

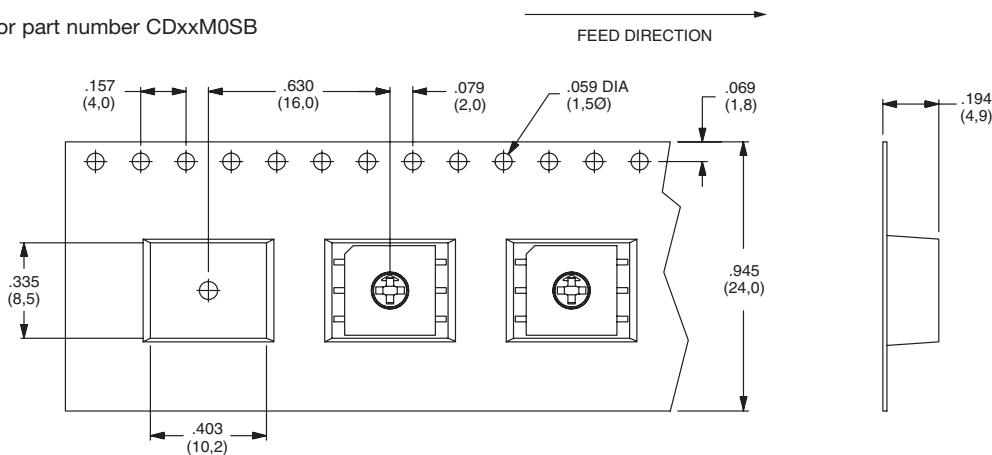

### Reel Information

Outside diameter 13.00 (333,0)  
Pilot hole .512 (13,0)

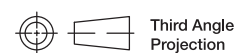

Third Angle Projection

## X-ON Electronics

Largest Supplier of Electrical and Electronic Components

*Click to view similar products for [Coded Rotary Switches](#) category:*

*Click to view products by [C&K](#) manufacturer:*

Other Similar products are found below :

[PT65SG178](#) [PT65SG23](#) [DRS4010](#) [CW1S-2E11](#) [S-1031A](#) [SBS1004](#) [P36S101TR](#) [P65THR101L254](#) [RM3AF-10R-V-T/R](#) [RH3HAF-10R-V-B](#)  
[PT65501RT](#) [P25SMT101TR](#) [P65SMT101](#) [P65THR101V](#) [MSDR-10H1](#) [GSDR-10S](#) [01-1433](#) [07-3153](#) [07-3154](#) [CRD10CM0SBR](#) [DRS4116](#)  
[94HCB16RAT](#) [94HCB10T](#) [94HBB16WT](#) [94HBB16RAT](#) [94HBB10WT](#) [94HBB10RAT](#) [94HBB08RAT](#) [94HAC10T](#) [94HAB16WT](#)  
[94HAB16T](#) [94HAB10WT](#) [94HAB10RAT](#) [94HAB08WT](#) [94HAB08RAT](#) [ND3FR10P](#) [ND3FR16B-R](#) [DRR3110](#) [94HEB08WRT](#)  
[94HCB16WT](#) [94HCB16T](#) [94HCB10RAT](#) [94HCB08T](#) [94HBB16T](#) [94HBB10T](#) [94HBB08T](#) [94HAB16RAT](#) [94HAB10T](#) [94HAB08T](#) [S-](#)  
[2011A](#)