



*Quality Products. Service Excellence.*

## Type 4, 4X Stainless Steel Pushbutton Enclosures *1435SS Series*



### Application

- Designed to accept standard heavy duty oil tight pushbuttons, switches and pilot lights.
- Provides protection from dirt, dust, oil and large amounts of water from any angle, or where highly corrosive conditions exist.

### Standards

- UL 508A Type 4 and 4X
- CSA Type 4 and 4X
- **Complies with**
  - NEMA Type 3R, 4 and 4X
  - IEC 60529, IP66
- Appropriate components are required to maintain these standards.

### Construction

- Formed 14 gauge stainless steel except A and B which are 16 gauge. 304 or 316 SS.
- Smooth continuously welded seams.
- Welded brackets provide for enclosure mounting.
- Captive stainless steel cover screws thread into sealed wells.
- Larger enclosures provide internally hinged removable covers, designed to hold the cover open during wiring.
- Oil resistant gasket and adhesive.
- A bonding stud is provided on the door and a grounding stud is provided on the enclosure.

### Finish

- Natural stainless steel with a smooth brushed finish.

### Accessories

- Hole Plugs
- Ground Wire Kits



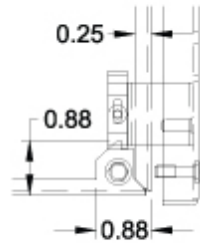
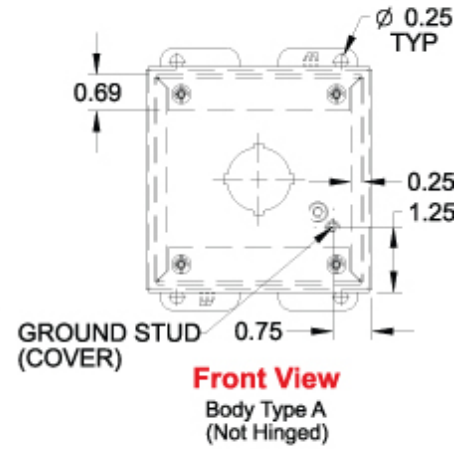
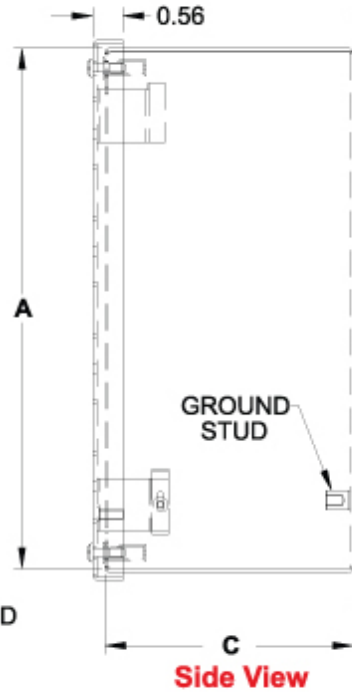
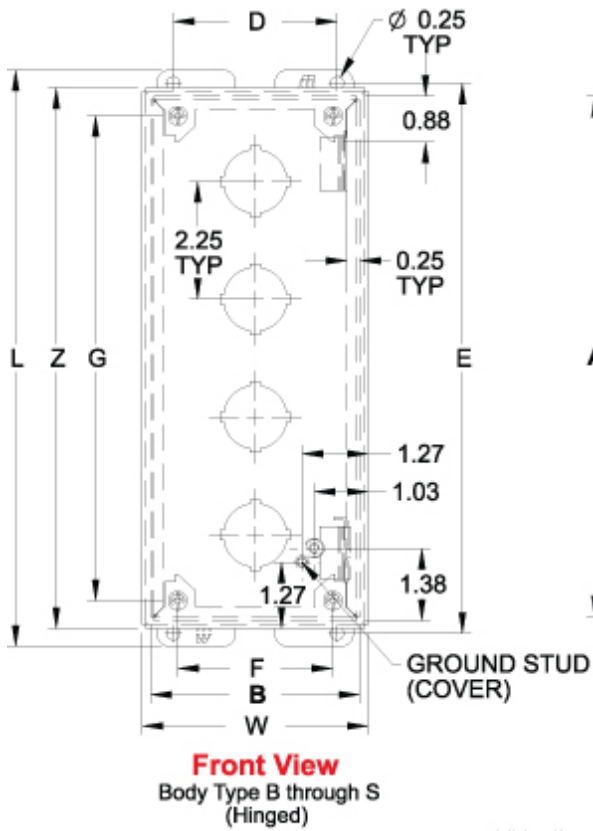

**Hinge Detail**  
Retractable pin allows door to be mounted on left or right side

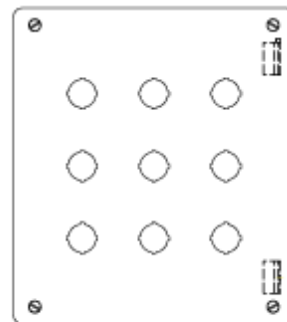
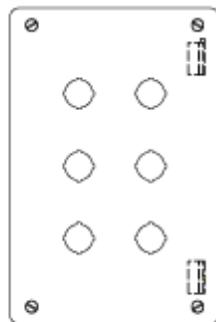
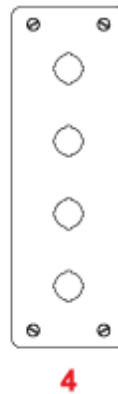
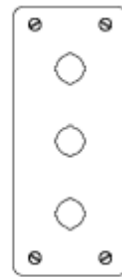
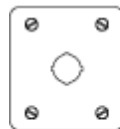
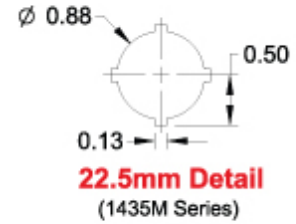
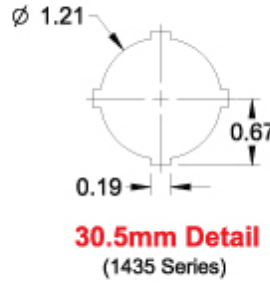

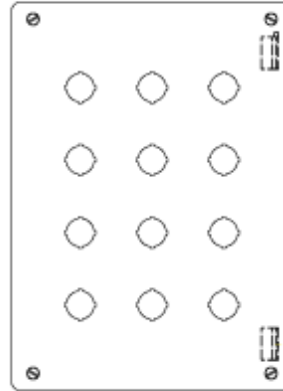

**12**

Part No.				No. Of Holes	Overall Dimensions									
304 S.S. 22.5mm	304 S.S. 30.5mm	316 S.S. 22.5mm	316 S.S. 30.5mm		A	B	C	D	E	F	G	L	W	Z
1435MSSA <sup>1</sup>	1435SSA <sup>1</sup>	1435MS16A <sup>1</sup>	1435S16A <sup>1</sup>	1	3.50	3.25	2.75	2.38	4.00	2.21	2.75	4.50	3.56	3.81
1435MSSB <sup>1</sup>	1435SSB <sup>1</sup>	1435MS16B <sup>1</sup>	1435S16B <sup>1</sup>	2	5.75	3.25	2.75	2.38	6.25	2.21	5.00	6.75	3.56	6.06
1435MSSC <sup>1</sup>	1435SSC <sup>1</sup>	1435MS16C <sup>1</sup>	1435S16C <sup>1</sup>	3	8.00	3.25	2.75	2.38	8.50	2.21	7.25	9.00	3.56	8.31
1435MSSD <sup>1</sup>	1435SSD <sup>1</sup>	1435MS16D <sup>1</sup>	1435S16D <sup>1</sup>	4	10.25	3.25	2.75	2.38	10.75	2.21	9.50	11.25	3.56	10.56
1435MSSH	1435SSH	1435MS16H	1435S16H	6	9.50	6.25	3.00	5.38	10.00	5.21	8.75	10.50	6.56	9.81
1435MSSK	1435SSK	1435MS16K	1435S16K	9	9.50	8.50	3.00	7.63	10.00	7.46	8.75	10.50	8.81	9.81
1435MSSO	1435SSO	1435MS16O	1435S16O	12	11.75	8.50	3.00	7.63	12.25	7.46	11.00	12.75	8.81	12.06

<sup>1</sup> Not hinged

*Data subject to change without notice*

## X-ON Electronics

Largest Supplier of Electrical and Electronic Components

*Click to view similar products for [Electrical Enclosures](#) category:*

*Click to view products by [Hammond](#) manufacturer:*

Other Similar products are found below :

[120-902](#) [120-905](#) [120-403](#) [120-475](#) [120-901](#) [127-410](#) [130-007](#) [130-504](#) [130-506](#) [MR-25L+](#) [30-8739](#) [PIP-11774SCREW](#) [30-9715](#) [MR-25LW+](#) [110-407](#) [111-004](#) [111-008](#) [110-402](#) [110-901](#) [110-907](#) [111-002](#) [110-406](#) [110-910](#) [110-404](#) [110-409](#) [110-410](#) [120-405](#) [106-009](#) [106-505](#) [105-401](#) [106-006](#) [104-406](#) [137-002](#) [105-405](#) [111-005](#) [127-909](#) [106-502](#) [130-475](#) [130-503](#) [127-401](#) [106-010](#) [127-455](#) [127-475](#) [110-903](#) [R260-180-300](#) [9511020](#) [9822029](#) [9820014](#) [P61603000P](#) [9823009](#)