



*Quality Products. Service Excellence.*

## Type 12 Mild Steel Modular Freestanding Disconnect Enclosure *UHD M Series*

Hinge Door with Handle (Flange w/ multi-vendor cutout)

### Application



- Designed to bolt together in any number of units for maximum flexibility and ease of transportation. The UHDM system consists of a Master enclosure to house the flange mounted disconnect switch and interlocking Slave enclosures which may be added or removed as required. Master enclosure units will accept the following disconnect switches and circuit breakers:
  - **ABB Controls** flange mounted variable depth operating mechanism for disconnect switches and circuit breakers.
  - **Allen Bradley** 1494F flange mounted disconnect switches and 1494D flange mounted operators for circuit breakers. Allen Bradley 1494V variable depth flange operated disconnect switches and circuit breaker mechanisms.
  - **C-H Westinghouse** Type C361 disconnect switches and operator mechanism. Cutler Hammer Type C371 circuit breaker operating mechanisms. Flex Shaft™ handle operators for circuit breakers.
  - **General Electric** Type STDA flange handles and variable depth operating mechanisms for disconnect switches and circuit breakers. Also Spectra-Flex™ cable operators for circuit breakers.
  - **I-T-E Max-Flex™** flange mounted variable depth operating handles for disconnect switches and circuit breakers.
  - **Square D** disconnect switches and circuit breakers used with Class 9422 flange mounted variable depth operating mechanisms or cable mechanisms. These enclosures will not receive Class 9422 bracket mounted disconnect devices or Class 9422TG1 or TG2 devices.

### Standards

- UL 508A Type 12
- CSA Type 12
- Complies with
  - NEMA Type 12
  - IEC 60529, IP54
- Appropriate components are required to maintain these standards.

### Construction

- Formed from 10 gauge steel with smooth continuously welded seams.
- Body stiffeners are provided in the larger enclosures for extra rigidity.
- Heavy duty lifting eyes are anchored into reinforced top corners.
- Removable doors are secured with heavy duty lift off hinges.
- Flange trough collar (FTC) around door excludes liquids and contaminants.
- Formed 10 gauge steel inner panels are provided on collar studs.
- Panel supports are provided.
- Center post is removable, providing easy panel installation.
- Heavy duty three point latching door mechanism.
- Side openings are reinforced to provide structural strength, smooth edges and preset gasket compression.



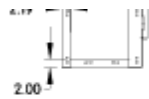

Open End

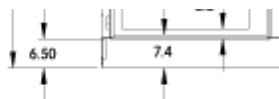

Front View



Closed End

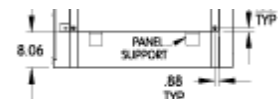

Rear View (Cross Section)

### Two Door Master Enclosure (Left side open)

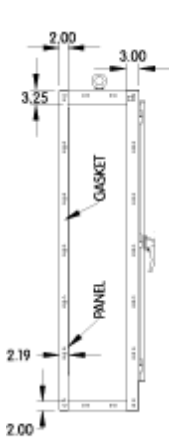

Open End

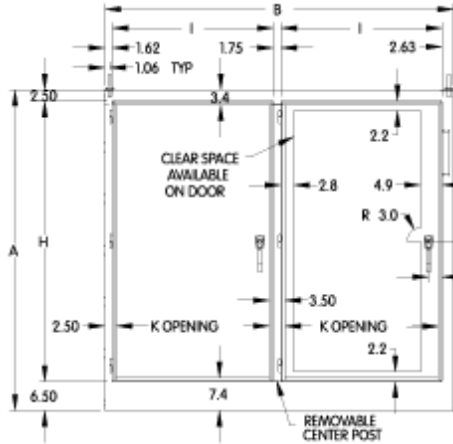

Front View



Closed End

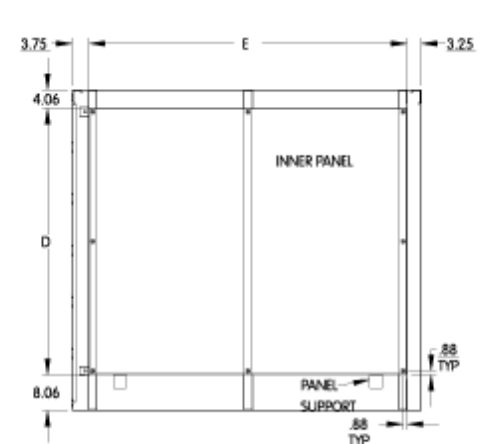

Rear View (Cross Section)

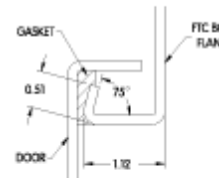

### Single Door Slave Enclosure (Both sides open)

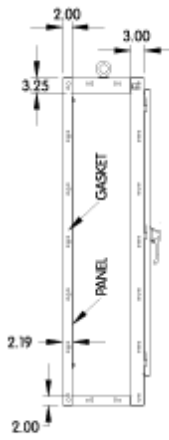

Open End

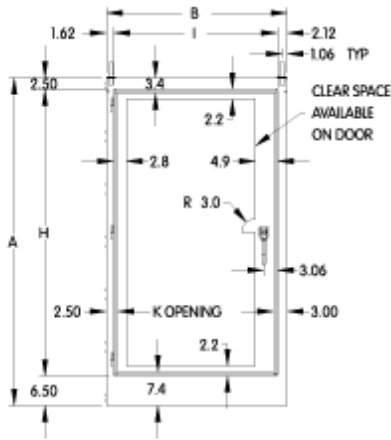

Front View

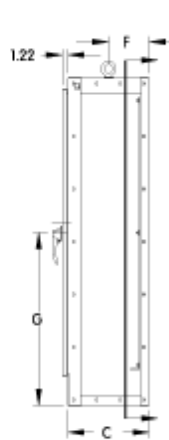

Open End

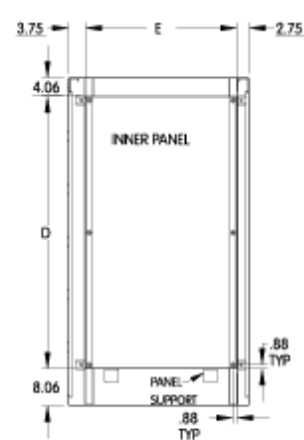

Rear View (Cross Section)

### Two Door Slave Enclosure (Both sides open)

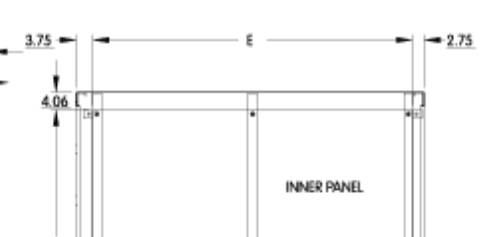
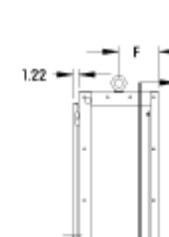
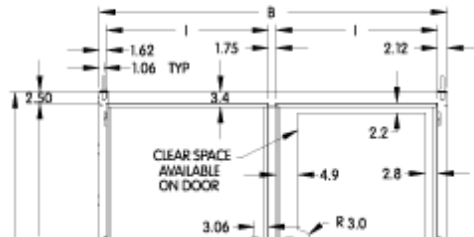
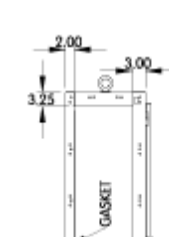

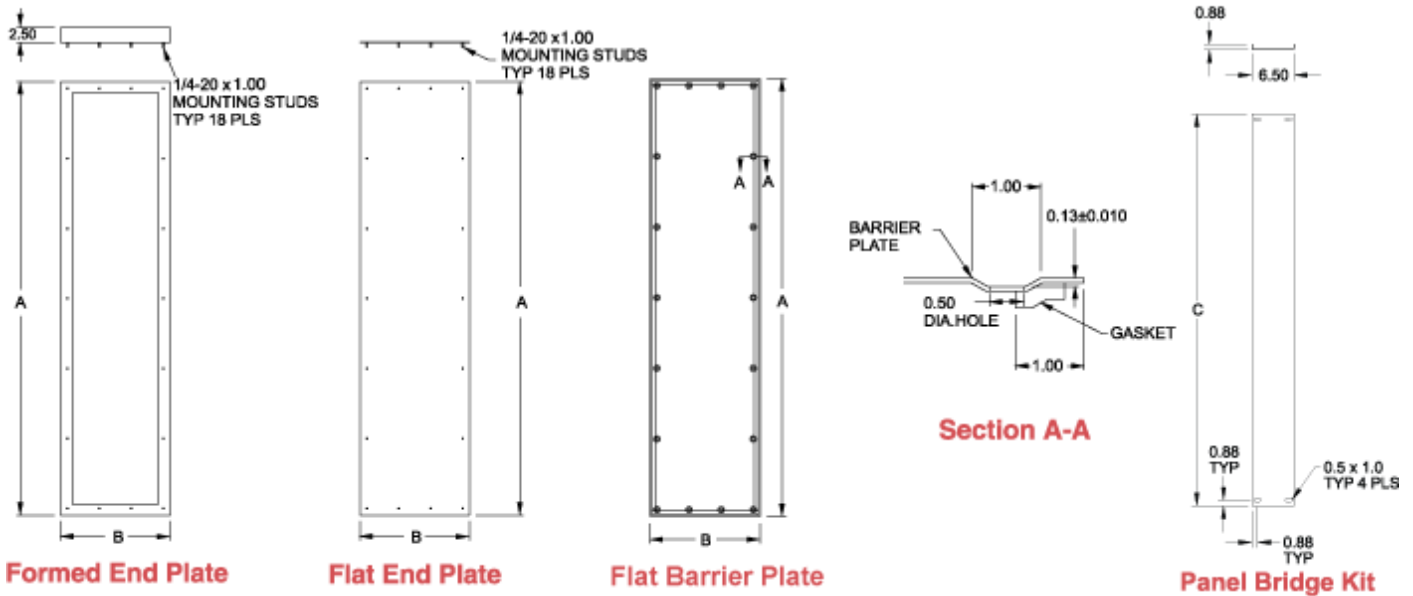
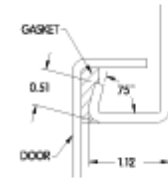
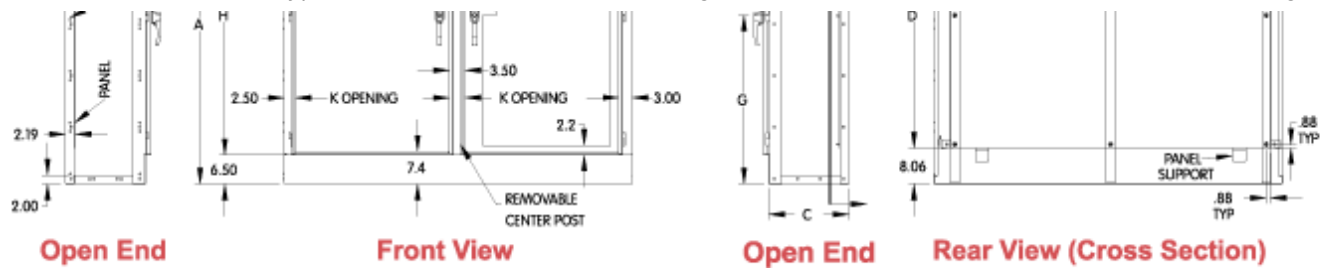

Master Enclosures

Part No.	Overall Dimensions										Description
	A	B	C	D	E	F	G	H	I	K	
UHDM724118MFTC	72.13	40.75	18.13	60.00	33.75	9.06	38.06	63.13	36.50	34.75	Single Door Disconnect
UHDM844118MFTC	84.13	40.75	18.13	72.00	33.75	9.06	44.06	75.13	36.50	34.75	Left side open
UHDM844124MFTC	84.13	40.75	24.13	72.00	33.75	12.06	44.06	75.13	36.50	34.75	
UHDM727918MFTC	72.13	79.00	18.13	60.00	72.00	9.06	38.06	63.13	36.50	34.75	Two Door Disconnect
UHDM847918MFTC	84.13	79.00	18.13	72.00	72.00	9.06	44.06	75.13	36.50	34.75	Left side open
UHDM847924MFTC	84.13	79.00	24.13	72.00	72.00	12.06	44.06	75.13	36.50	34.75	

Slave Enclosures

Part No.	Overall Dimensions										Description
	A	B	C	D	E	F	G	H	I	K	
UHDM724118SFTC	72.13	40.25	18.13	60.00	33.75	9.06	38.06	63.13	36.50	34.75	Single Door Slave
UHDM844118SFTC	84.13	40.25	18.13	72.00	33.75	9.06	44.06	75.13	36.50	34.75	Both sides open
UHDM844124SFTC	84.13	40.25	24.13	72.00	33.75	12.06	44.06	75.13	36.50	34.75	
UHDM727818SFTC	72.13	78.50	18.13	60.00	72.00	9.06	38.06	63.13	36.50	34.75	Two Door Slave
UHDM847818SFTC	84.13	78.50	18.13	72.00	72.00	9.06	44.06	75.13	36.50	34.75	Both sides open
UHDM847824SFTC	84.13	78.50	24.13	72.00	72.00	12.06	44.06	75.13	36.50	34.75	

Accessories

Part No.	A	B	C	Description
----------	---	---	---	-------------

Part No.	A	B	C	Description
UHDM7218ECA	71.86	17.87	-	Formed end plate with mounting hardware
UHDM8418ECA	83.87	17.87	-	Formed end plate with mounting hardware
UHDM8424ECA	83.87	23.87	-	Formed end plate with mounting hardware
UHDM7218EPA	71.87	17.87	-	Flat end plate with mounting hardware
UHDM8418EPA	83.87	17.87	-	Flat end plate with mounting hardware
UHDM8424EPA	83.87	23.87	-	Flat end plate with mounting hardware
UHDM7218BPA	71.87	17.87	-	Flat barrier plate with mounting hardware
UHDM8418BPA	83.87	17.87	-	Flat barrier plate with mounting hardware
UHDM8424BPA	83.87	21.87	-	Flat barrier plate with mounting hardware
UHDMFTC72BK	-	-	60.00	Inner panel bridge kit
UHDMFTC84BK	-	-	72.00	Inner panel bridge kit

*Data subject to change without notice*

© 2018. Hammond Manufacturing Ltd. All rights reserved.

## X-ON Electronics

Largest Supplier of Electrical and Electronic Components

*Click to view similar products for [Electrical Enclosures](#) category:*

*Click to view products by [Hammond](#) manufacturer:*

Other Similar products are found below :

[120-902](#) [120-905](#) [120-403](#) [120-475](#) [120-901](#) [127-410](#) [130-504](#) [130-506](#) [MR-25L+](#) [30-8739](#) [PIP-11774SCREW](#) [30-9715](#) [MR-25LW+](#) [110-407](#) [111-004](#) [111-008](#) [110-402](#) [110-901](#) [110-907](#) [111-002](#) [110-406](#) [110-910](#) [110-404](#) [110-409](#) [110-410](#) [120-405](#) [106-009](#) [106-505](#) [105-401](#) [106-006](#) [104-406](#) [137-002](#) [105-405](#) [111-005](#) [127-909](#) [106-502](#) [130-475](#) [130-503](#) [127-401](#) [106-010](#) [127-455](#) [127-475](#) [110-903](#) [R260-180-300](#) [9511020](#) [9822029](#) [9820014](#) [P61603000P](#) [9823009](#) [R103-164-000](#)