

## Pin strip - PST 1,0/ 3-3,5 R24 - 1720246

Please be informed that the data shown in this PDF Document is generated from our Online Catalog. Please find the complete data in the user's documentation. Our General Terms of Use for Downloads are valid (<http://phoenixcontact.com/download>)



Pin strip, nominal current: 8 A, rated voltage (III/2): 250 V, number of positions: 3, pitch: 3.5 mm, color: black, contact surface: Tin, mounting: THR soldering. The maximum current depends on the plug used. The lower of the two current values apply for plug and pin strip. The pin strip is made of highly temperature resistant plastic and is thus suitable for the reflow process.

The figure shows an 8-pos. version of the item in tape-on-reel packing

### Your advantages

- ✓ Suitable for wave and reflow soldering processes
- ✓ Optimum pin geometry for all COMBICON pin strip connectors

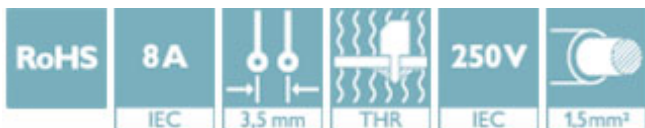

### Key Commercial Data

Packing unit	330 pc
Minimum order quantity	330 pc
GTIN	
GTIN	4046356115650

### Technical data

#### Dimensions

Length [ l ]	2.8 mm
Width	10.1 mm
Pitch	3.5 mm
Dimension a	7 mm
Width [ w ]	10.1 mm
Height [ h ]	12.7 mm
Height	9.2 mm
Length of the solder pin	3.5 mm
Pin dimensions	ø 1 mm
Pin spacing	3.50 mm
Length	2.8 mm

# Pin strip - PST 1,0/ 3-3,5 R24 - 1720246

## Technical data

### General

Range of articles	PST 1,0/..-V
Insulating material group	IIIa
Rated surge voltage (III/3)	2.5 kV
Rated surge voltage (III/2)	2.5 kV
Rated surge voltage (II/2)	2.5 kV
Rated voltage (III/3)	160 V
Rated voltage (III/2)	250 V
Rated voltage (II/2)	250 V
Connection in acc. with standard	EN-VDE
Nominal current $I_N$	8 A (depends on the plug used)
Maximum load current	8 A (depends on the plug used)
Insulating material	PA
Flammability rating according to UL 94	V0
Color	black
Number of positions	3

### Standards and Regulations

Connection in acc. with standard	EN-VDE
	CUL
Flammability rating according to UL 94	V0

### Environmental Product Compliance

China RoHS	Environmentally friendly use period: unlimited = EFUP-e
	No hazardous substances above threshold values

## Drawings

Drilling diagram

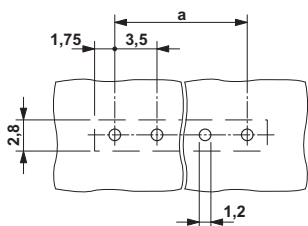

Dimensional drawing

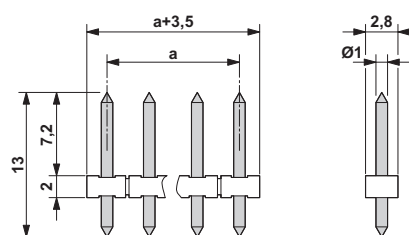

# Pin strip - PST 1,0/ 3-3,5 R24 - 1720246

Dimensional drawing

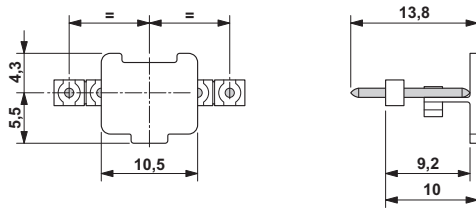

Dimensional drawing

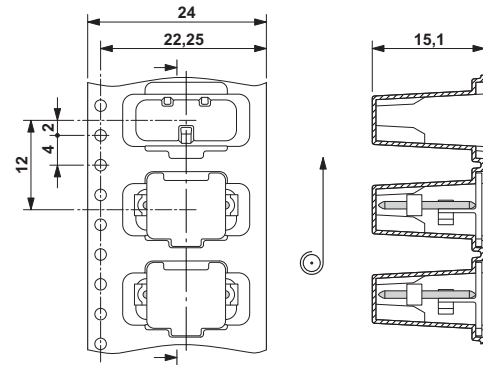

## Approvals

### Approvals

Approvals

SEV / SEV / EAC / cULus Recognized

Ex Approvals

### Approval details

SEV		<a href="https://www.electrosuisse.ch/de/meta/shop/produktezertifikate.html">https://www.electrosuisse.ch/de/meta/shop/produktezertifikate.html</a>	IK-3558-M2
Nominal voltage UN		160 V	
Nominal current IN		6 A	

SEV		<a href="https://www.electrosuisse.ch/de/meta/shop/produktezertifikate.html">https://www.electrosuisse.ch/de/meta/shop/produktezertifikate.html</a>	IK-3558-M2
Nominal voltage UN		160 V	
Nominal current IN		4 A	
mm <sup>2</sup> /AWG/kcmil		0.5	

## Pin strip - PST 1,0/ 3-3,5 R24 - 1720246

### Approvals

EAC		B.01742
-----	---	---------

cULus Recognized		<a href="http://database.ul.com/cgi-bin/XYV/template/LISEXT/1FRAME/index.htm">http://database.ul.com/cgi-bin/XYV/template/LISEXT/1FRAME/index.htm</a>	E60425-20030211
		B	
Nominal voltage UN		300 V	
Nominal current IN		10 A	

Phoenix Contact 2018 © - all rights reserved  
<http://www.phoenixcontact.com>

PHOENIX CONTACT GmbH & Co. KG  
Flachsmarktstr. 8  
32825 Blomberg  
Germany  
Tel. +49 5235 300  
Fax +49 5235 3 41200  
<http://www.phoenixcontact.com>

## X-ON Electronics

Largest Supplier of Electrical and Electronic Components

*Click to view similar products for [Headers & Wire Housings](#) category:*

*Click to view products by [Phoenix Contact](#) manufacturer:*

Other Similar products are found below :

[95000-104TRLF](#) [10135584-644402LF](#) [DF62W-EP2022PCA](#) [95000-106TRLF](#) [DF62W-2022SCA](#) [DF62W-EP2022PC](#) [2203348](#) [DF62W-2022SC](#) [1084018](#) [1029039](#) [1084017](#) [802-10-012-10-002000](#) [1112640](#) [1112639](#) [000-34000](#) [0009482033](#) [0009507031](#) [57102-S06-03LF](#) [57202-S52-04LF](#) [PCN6-15S-2.5E](#) [0039019024](#) [58102-G61-06LF](#) [582553-1](#) [0009485154](#) [0009508121](#) [0022285053](#) [0050291907](#) [018731A](#) [LY20-4P-DT1-P1E-BR](#) [02.125.8002.8](#) [60101931](#) [60598-1 \(Cut Strip\)](#) [M1625-3R/100](#) [61062-3](#) [61082-181009](#) [636-1427](#) [638009-1](#) [641938-9](#) [641991-4](#) [644168-1](#) [647662-1](#) [65039-019ELF](#) [65817-002LF](#) [65817-015LF](#) [65863-015LF](#) [66207-023LF](#) [67016-026LF](#) [67046-001LF](#) [67095-007LF](#) [67230-005LF](#)