

### RKT/LED

Aktor-/Sensor-Anschlussleitung, M12-Kupplung mit LED-Betriebs- und Funktionsanzeige, selbstsicherndem Schraubverschluss und angespritztem Kabel

Actuator/sensor cordset, single-ended, M12 female connector with LED operation and function indicator, self-locking threaded joint and molded cable

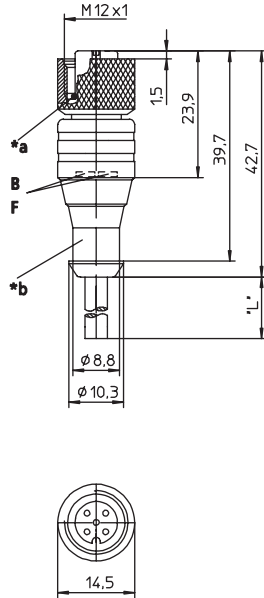

### RKWT/LED

Aktor-/Sensor-Anschlussleitung, M12-Winkelkupplung mit LED-Betriebs- und Funktionsanzeige, selbstsicherndem Schraubverschluss und angespritztem Kabel

Actuator/sensor cordset, single-ended, M12 female right angle connector with LED operation and function indicator, self-locking threaded joint and molded cable

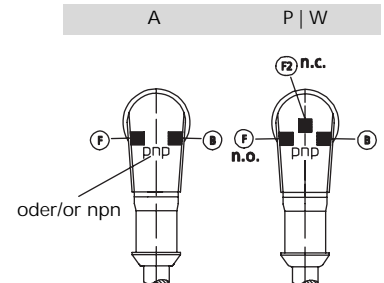
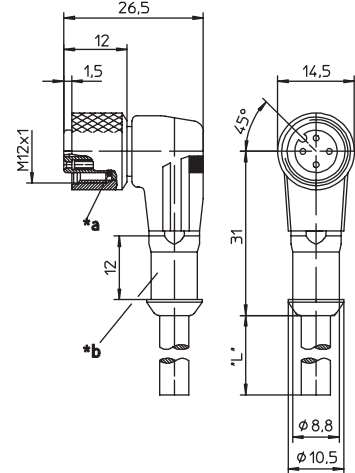

### Pinbelegung Pin assignment

#### 3-polig 3 poles

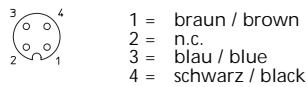

#### 4-polig 4 poles

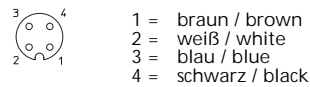

\*a O-Ring  
O-ring

\*b Schutzschlauchmontage  
hose mounting

B Betriebsanzeige grün  
operation indicator green

F Funktionsanzeige gelb  
function indicator yellow

F2 Funktionsanzeige  
gelb = P, weiß = W  
function indicator  
yellow = P, white = W

### Schaltbild Wiring diagram

**A** pnp-Schließer /  
pnp Normally open =  
gelb-grün / yellow-green

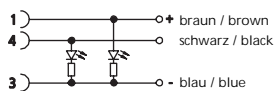

**P** pnp-Öffner/Schließer /  
pnp-Normally closed/open =  
gelb-gelb-grün (Antivalent) /  
yellow-yellow-green

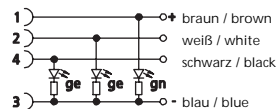



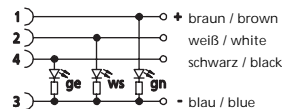





















**W** pnp-Öffner/Schließer /  
pnp-Normally closed/open =  
gelb-weiß-grün (Antivalent) /  
yellow-white-green



Sonderbeschaltungen auf Anfrage / Special circuits on request

## Anschlussleitungen für Aktoren, Sensoren und Verteiler Cordsets, single-ended, for actuators, sensors and distribution boxes

Technische Daten		Technical data	
Umgebungstemperatur	-25°C / +80°C	Operating temperature range	-25°C / +80°C
<b>Werkstoffe</b>		<b>Materials</b>	
Gehäuse / Griffkörper	TPU	Housing / Molded body	TPU
Kontaktträger	TPU	Insert	TPU
Kontakt	CuSn, unternickelt und 0,3 µm vergoldet	Contact	CuSn, pre-nickeled and 0.3 microns gold-plated
Gewindebuchse / Rändelschraube/-mutter / Sechskantschraube/-mutter / Hülse	CuZn, vernickelt	Receptacle shell / knurled screw/nut / hexagon screw/nut / sleeve	CuZn, nickel-plated
O-Ring	FKM	O-ring	FKM
<b>Mechanische Daten</b>		<b>Mechanical data</b>	
Schutzart	IP 67 Nur im verschraubten Zustand mit den dazugehörigen Gegenstücken.	Degree of protection	IP 67 Only in locked position with its proper counterparts.
<b>Elektrische Daten</b>		<b>Electrical data</b>	
Durchgangswiderstand	≤ 5 mΩ	Contact resistance	≤ 5 mΩ
Nennstrom bei 40°C	4 A	Nominal current at 40°C	4 A
Nennspannung	10–30 V DC	Nominal voltage	10–30 V DC
Bemessungsspannung	32 V	Rated voltage	32 V
Isolationswiderstand	> 10 <sup>9</sup> Ω	Insulation resistance	> 10 <sup>9</sup> Ω
Verschmutzungsgrad	3	Pollution degree	3

Bestellbezeichnung Designation		Polzahl Poles	Mantel Outer jacket	
RKT/LED A 4-3-06/... M	RKWT/LED A 4-3-06/... M		PVC	 
RKT/LED A 4-3-224/... M	RKWT/LED A 4-3-224/... M	3	PUR halogenfrei / halogen free	   
RKT/LED A 4-3-260/... M	RKWT/LED A 4-3-260/... M		PUR halogenfrei / halogen free schweißfunkenfest / welding spark proof	    
	RKWT/LED P 4-07/... M		PVC	
	RKWT/LED P 4-225/... M	4	PUR halogenfrei / halogen free	   
	RKWT/LED P 4-251/... M		PUR halogenfrei / halogen free schweißfunkenfest / welding spark proof	    
	RKWT/LED W 4-265/... M	4	PUR halogenfrei / halogen free	   

Standardlängen: 2 M / 5 M / 10 M      Standard lengths: 2 M / 5 M / 10 M  
 Andere Kabellängen oder Leitungsaufbauten auf Anfrage.      Other cable lengths or cable specifications on request.

Ein Einsatz der Produkte in aggressiven Medien ist im Einzelfall zu überprüfen.

The application of these products in harsh environments should always be checked before use.

## X-ON Electronics

Largest Supplier of Electrical and Electronic Components

*Click to view similar products for [Sensor Cables / Actuator Cables](#) category:*

*Click to view products by [Lumberg](#) manufacturer:*

Other Similar products are found below :

[1300070444](#) [43-10984](#) [M83513/19-F01CP](#) [704000D02F120](#) [MDM15SH001K](#) [MDM25PH003BF222](#) [802027107404-1](#) [885030A09M010](#)  
[885030A09M020](#) [1200650174](#) [1200651332](#) [1200651713](#) [1200660171](#) [1200660208](#) [1200660343](#) [1200660804](#) [1200660845](#) [1200660926](#)  
[1200660977](#) [1200661173](#) [1200661354](#) [120066-1712](#) [1200720053](#) [1200720099](#) [1200720153](#) [1200720172](#) [1200720217](#) [1200720226](#)  
[1200720251](#) [1200720285](#) [1200720296](#) [1200720404](#) [1200730148](#) [1200730378](#) [1200800231](#) [1200860112](#) [1200860121](#) [1200860125](#)  
[1200860337](#) [1200860365](#) [1200860420](#) [1200870046](#) [1200870123](#) [1200870248](#) [1200980102](#) [1200660181](#) [1200660183](#) [1200660827](#)  
[1200660849](#) [1200661170](#)