

# 3MS/3MN/3MA

## 3M-Series

### MINIATURE PUSHBUTTONS

The 3M family of miniature pushbutton switches is composed of four switch series; the **3MNH-Series** premium sealed snap-action pushbutton, the **3MN-Series** snap-action pushbutton, the **3MS-Series** sealed snap-action pushbutton, and the **3MA-Series** alternate-action pushbutton. These PC mount pushbutton switches offer a variety of ratings, circuits, contact materials, terminal platings, pushbutton styles, and optional color caps.



3MNH-Series

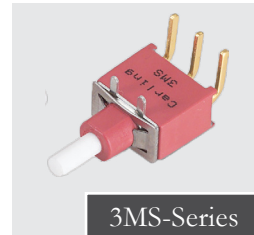

3MS-Series

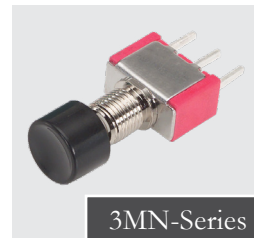

3MN-Series

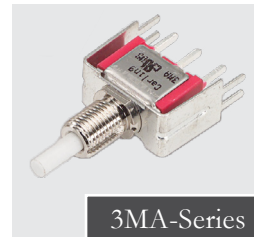

3MA-Series

#### Product Highlights:

- IP67 Sealing
- Snap Action Contact Mechanism
- Variety of Plunger and Bushing Lengths
- Up to 14 Termination Choices
- UL and cUL Approvals
- Sleek Black Finish

#### Typical Applications:

- Telecommunications
- Performance Audio
- Networking
- Computers
- Instrumentation
- Low Power On/Off Designs

#### Resources:

[Configure a Complete Part](#)

[Download CAD & Sales Drawing >](#)



**Carling Technologies®**

Innovative Designs. Powerful Solutions.

**Carling Technologies, Inc.**  
60 Johnson Avenue, Plainville, CT 06062  
Email: [sales@carlingtech.com](mailto:sales@carlingtech.com)  
Application Support: [team2@carlingtech.com](mailto:team2@carlingtech.com)  
Phone: 860.793.9281 Fax: 860.793.9231

[www.carlingtech.com](http://www.carlingtech.com)



**3MNH-Series**  
Premium Sealed  
Miniature Pushbutton Switch

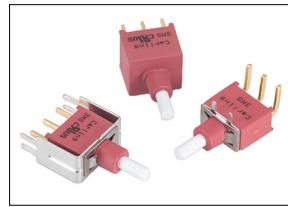

**3MS-Series**  
Sealed Snap-Action  
Miniature Pushbutton Switch



**3MN-Series**  
Snap-Action  
Miniature Pushbutton Switch

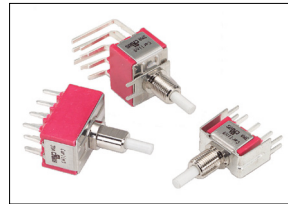

**3MA-Series**  
Alternate Action  
Miniature Pushbutton Switch

### Electrical

Contact Rating	refer to ordering scheme
Electrical Life	50,000 make & break cycles @ full load
Contact Resistance	<b>3MS-Series:</b> 50 mΩ max. initial @ 2-4 VDC 100mA for both silver & gold plated contacts. <b>3MN, 3MA &amp; 3NMH-Series:</b> 10 mΩ max. initial @ 2-4 VDC 100mA for both silver & gold plated contacts.
Insulation Resistance	1000 MΩ min.
Dielectric Strength	1500 Volts RMS @ sea level

### Physical

Operating Temperature	-30°C to +85°C
Index of Protection	<b>3MS-Series:</b> IP68 <b>3MNH-Series:</b> IP67
Cap Installation Support	<b>3MS-Series:</b> 10 lbs. max.
Solder Heat Resistance	MIL-STD-202, Method 210

### Material

Case	<b>3MS-Series:</b> Glass filled nylon 6/6, flame retardant, heat stabilized (UL94V-0) <b>3MN, 3MA &amp; 3NMH-Series:</b> Diallyl phthalate (DAP) (UL 94V-0)
Plunger	<b>3MS &amp; 3MA-Series:</b> Glass filled nylon or glass filled polyester (UL94V-0) <b>3MN-Series:</b> Thermoplastic polyester, black <b>3NMH-Series:</b> Brass, black finish with o-ring seal
Bushing	<b>3MN-Series:</b> Brass, nickel plated <b>3MA-Series:</b> Zinc, nickel plated <b>3NMH-Series:</b> Brass, black finish with o-ring seal
Housing	<b>3MN &amp; 3MA-Series:</b> Stainless Steel
Switch Support Retainer	<b>3MS-Series:</b> Stainless Steel
Terminal Seal	Epoxy

\*Manufacturer reserves the right to change product specification without prior notice.



**1 SERIES**

**3MNH** Premium Sealed Miniature Pushbutton Switch

**2 POLES**

**SP** Single pole - uses terminals 1, 2 & 3  
**DP** Double pole - uses terminals 1, 2, 3, 4, 5 & 6

**3 CIRCUIT**

( ) - momentary

<b>Switching Position:</b>	1	2
<b>1</b>	ON	ON
<b>7</b>	ON	(ON)

Note: Plunger at rest in Position 1. Plunger depressed in Position 2.

**4 PLUNGER 1**

**PJ** .325 height [8.25 mm]  
**PA** .157 height [4.00 mm]  
**PB** .354 height [9.00 mm]

**5 BUSHING 2**

**BJ**<sup>3</sup> Threaded 15/32, flat, .553 height [14.05 mm]  
**BL**<sup>4</sup> Threaded 15/32, flat, .295 height [7.49 mm]

**6 TERMINATION**

**M1** Solder Lug  
**M2** PC thru-hole  
**M51** Wire wrap, .711" [18.05 mm]  
**M52** Wire wrap, .924" [23.48 mm]  
**M53** Wire wrap, .386" [9.80 mm]

**7 CONTACTS / TERMINALS**

	Contact Material	Terminal Plating	Rating	Approvals
<b>G</b>	silver <sup>5</sup>	gold over silver	(SP1, DP1) 6A@125VAC or 28VDC 3A@250VAC (SP7, DP7) 1A@120VAC or 38VDC	c  us, IP67
<b>Q</b>	silver <sup>5</sup>	silver <sup>5</sup>	(SP1, DP1) 6A@125VAC or 28VDC 3A@250VAC (SP7, DP7) 1A@120VAC or 38VDC	c  us, IP67
<b>R</b>	gold <sup>6</sup>	gold <sup>7</sup>	0.4VA max @ 20V max (AC/DC)	N/A

**8 EPOXY SEAL**

**E** Epoxy Seal

Notes:

- 1 PJ Plunger for maintained circuits only. PA and PB Plunger for momentary circuits only
- 2 Hardware includes (1) 2M1-HDW4 nut and (1) 3MNH-WCP-0872 o-ring
- 3 BJ Bushing only available with PJ Plunger
- 4 BL Bushing only available with PA or PB Plunger
- 5 Movable contact & terminal platings: silver over copper alloy
- 6 Movable Contact platings: gold over nickel over copper alloy
- 7 Terminal platings: gold over nickel over copper alloy

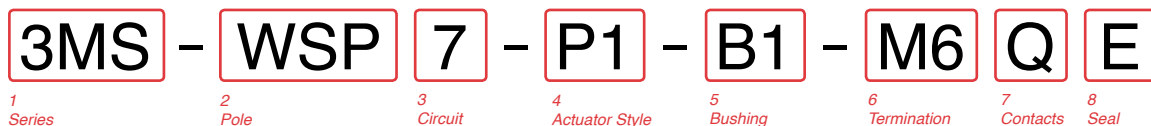

**1 SERIES**

**3MS** Sealed Snap-Action Miniature Pushbutton Switch

**2 POLES**

**WSP** Single pole - uses terminals 1, 2 & 3  
**WDP** Double pole - uses terminals 1, 2, 3, 4, 5 & 6

**3 CIRCUIT**

( ) - momentary

<b>Switching Position:</b>	1	2
<b>7</b>	2-3, 5-6 ON	2-1, 5-4 (ON)

Note: Plunger at rest in Position 1. Plunger depressed in Position 2.

**4 ACTUATOR STYLE**

**P1** Standard Plunger  
**P2** Long Plunger  
**P3** Short Plunger

**5 BUSHING**

**B1**<sup>1</sup> Threaded, with keyway, .350 height [8.89 mm]  
**B4** Unthreaded, flatted, .250 height [6.35 mm]

**6 TERMINATION**

**M1** Solder Lug  
**M2** PCB  
**M6** PC Mount, 90° horizontal  
**M61** Snap-In, 90° horizontal  
**M7** PC Mount, 90° vertical  
**M71** Snap-In, 90° vertical  
**VS2** PC Mount, U bracket, .620" mounting x .461" height  
**VS21** Snap-In, U bracket, .620" mounting x .461" height  
**VS3** PC Mount, U bracket, .620" mounting x .630" height  
**VS31** Snap-In, vertical, .630" height  
**VS4** PC Mount, U bracket, .750" mounting x .461" height  
**VS41** Snap-In, vertical, .461 height  
**VS5** PC Mount, U bracket, .750" mounting x .630" height  
**VS51** Snap-In, vertical, .630" height

**7 CONTACTS / TERMINALS**

	Contact Material	Terminal Plating	Rating	Approvals
<b>G</b>	silver <sup>3</sup>	gold over silver	1A 120VAC or 38VDC	c  us, IP68
<b>Q</b>	silver <sup>3</sup>	silver <sup>3</sup>	1A 120VAC or 38VDC	c  us, IP68
<b>R</b>	gold <sup>2</sup>	gold <sup>2</sup>	0.4VA max 20V max (AC/DC)	IP68

**8 EPOXY SEAL**

**E** Epoxy Seal **0** without Epoxy Seal

Notes:

- 1 Hardware includes (2) 2M1-HDW2 nuts, (1) 2M1-HDW11 washer, and (1) 2M1-HDW15 locking ring
- 2 Movable contact and terminal platings: gold over nickel over copper alloy
- 3 Movable contact and terminal platings: silver over copper alloy

### 3MN-Series with Square Actuator

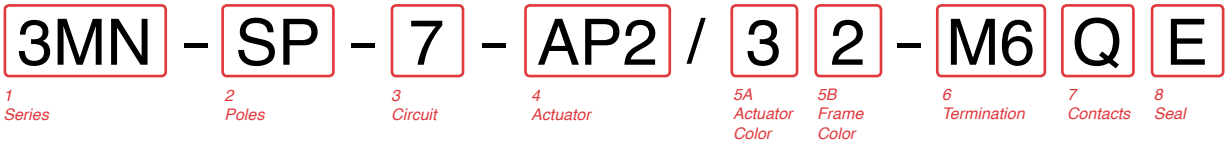

### 3MN-Series with Plunger Actuator

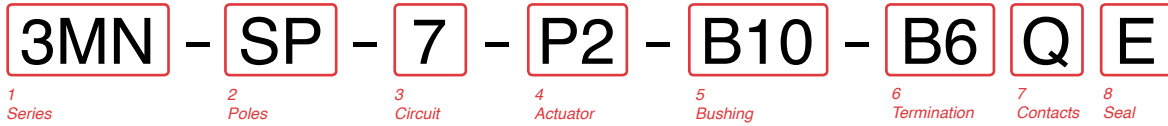

#### 1 SERIES

**3MN** Snap-Action Miniature Pushbutton Switch

#### 2 POLES

**SP** Single pole - uses terminals 1, 2 & 3  
**DP** Double pole - uses terminals 1, 2, 3, 4, 5 & 6

#### 3 CIRCUIT

( ) - momentary

<b>Switching Position:</b>	<b>1</b>	<b>2</b>
	2-3, 5-6	2-1, 5-4
<b>7</b>	ON	(ON)

Note: Plunger at rest in Position 1. Plunger depressed in Position 2.

#### 4 ACTUATOR

**Square Actuator** (use with Color Options in Selection 5A & 5B)

**AP1** Square with no frame  
**AP2** Square raised above frame  
**AP3** Square flush with frame

**Plunger Actuator** (use with Bushing Options in Selection 5)

**P0** Flush Plunger  
**P1** Standard Plunger  
**P2** Short Plunger

#### 5A ACTUATOR COLOR & 5B FRAME COLOR <sup>3,4</sup>

**1** White  
**2** Black  
**3** Red

#### OR

#### 5B BUSHING

**B6** Unthreaded (for terminations VS6-VS9 only)  
**B10**<sup>1</sup> Threaded keyway  
**B11**<sup>2</sup> Threaded with flat  
**B20** Unthreaded keyway  
**B21** Unthreaded with flat

#### 6 TERMINATION

**M1** Solder Lug  
**M2** PCB  
**M51** Wire Wrap .750 [19.05]  
**M52** Wire Wrap .964 [24.40]  
**M53** Wire Wrap .425 [10.80]  
**M6** PC Mount, 90° horizontal  
**M7** PC Mount, 90° vertical  
**VS2** PC Mount, U bracket, .620" mounting x .461" height  
**VS3** PC Mount, U bracket, .620" mounting x .630" height  
**VS4** PC Mount, U bracket, .750" mounting x .461 height  
**VS5** PC Mount, U bracket, .750" mounting x .630" height  
**VS6** PC Mount, U bracket, .461 height (for B6 bushing only)  
**VS7** PC Mount, U bracket, .630 height (for B6 bushing only)  
**VS8** PC Mount, U bracket, .461 height (for B6 bushing only)  
**VS9** PC Mount, U bracket, .630 height (for B6 bushing only)

#### 7 CONTACTS / TERMINALS

	Contact Material	Terminal Plating	Rating	Approvals
<b>G</b>	silver	gold over silver	1A 125VAC or 28VDC	
<b>Q</b>	silver <sup>5</sup>	silver <sup>5</sup>	1A 125VAC or 28VDC	
<b>R</b>	gold <sup>6</sup>	gold <sup>6</sup>	0.4VA max 20V max (AC/DC)	

#### 8 EPOXY SEAL

**E** Epoxy Seal **0** without Epoxy Seal

#### Notes:

- Hardware includes (2) 2M1-HDW2 nuts, (1) 2M1-HDW11 washer, and (1) 2M1-HDW15 locking ring
- Hardware includes (2) 2M1-HDW2 nuts, (1) 2M1-HDW11 washer, and (1) 2M1-HDW16 locking ring
- Selection 5B is blank if actuator style is AP1 (no frame)
- Black, white and red are standard. Other colors available, consult factory for details.
- Movable contact & terminal platings: silver over copper alloy
- Movable contact & terminal platings: gold over nickel over copper alloy



## 3MNH-Series Dimensional Specifications: in. [mm]

### Single Pole Maintained Circuit

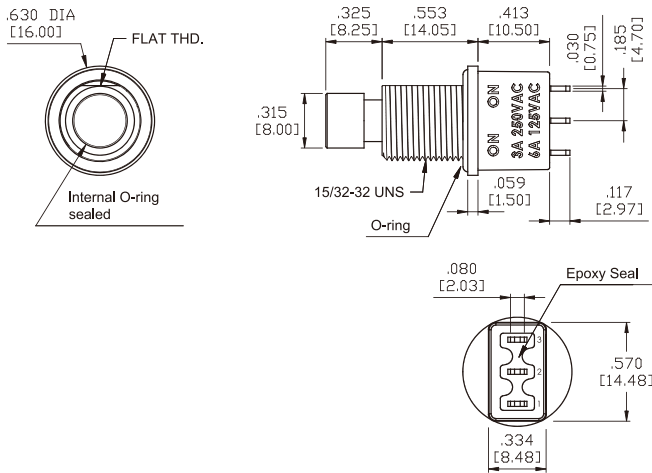

### Single Pole Momentary Circuit

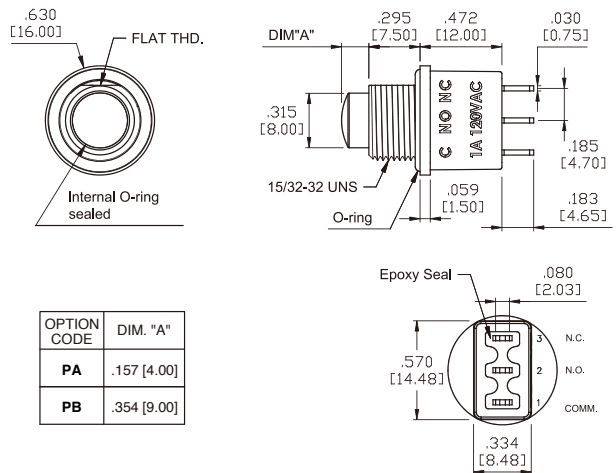

### Double Pole Maintained Circuit

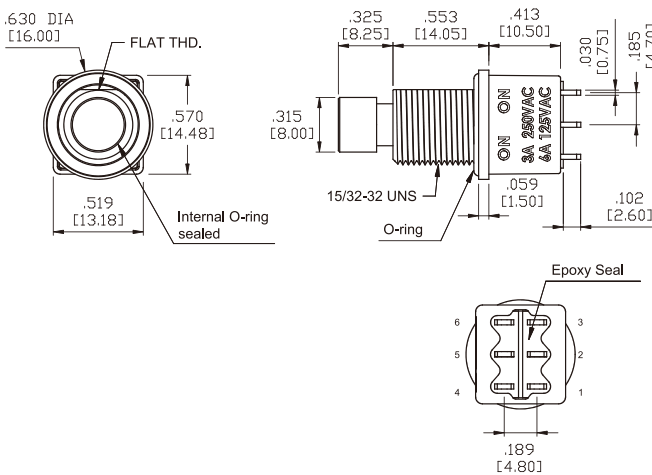

### Double Pole Momentary Circuit

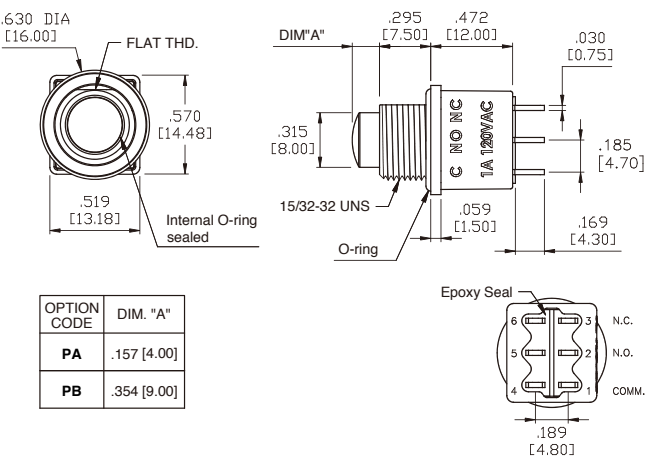

### Panel Mounting

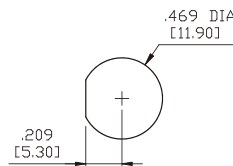

15/32-32 UNS FLAT-CUT  
THREADED BUSHING

### M1 Standard Solder Lug

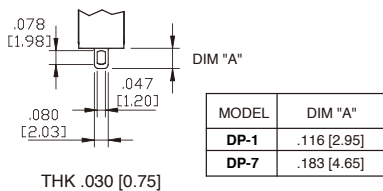

### Termination Options

#### M2 PC Thru-Hole

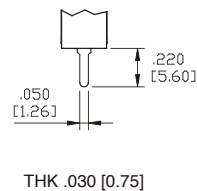

#### M5 Wire Wrap

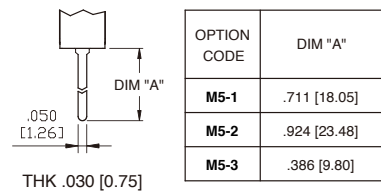

## 3MS-Series Dimensional Specifications: in. [mm]

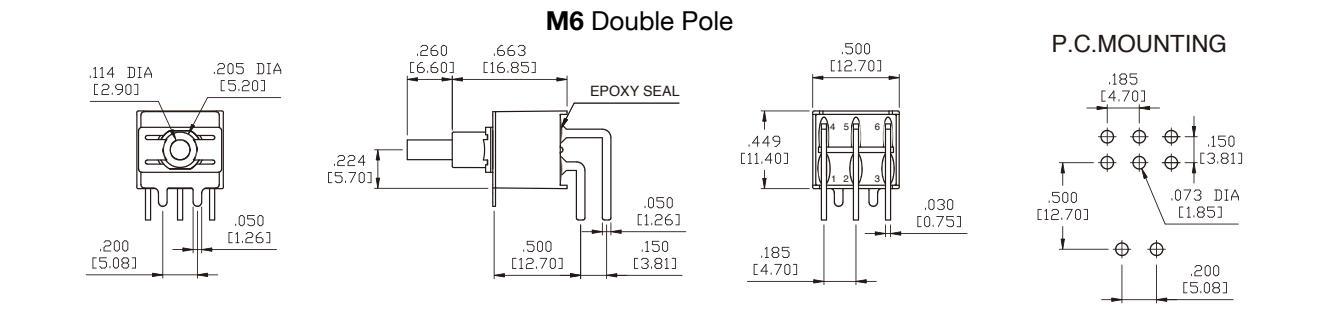
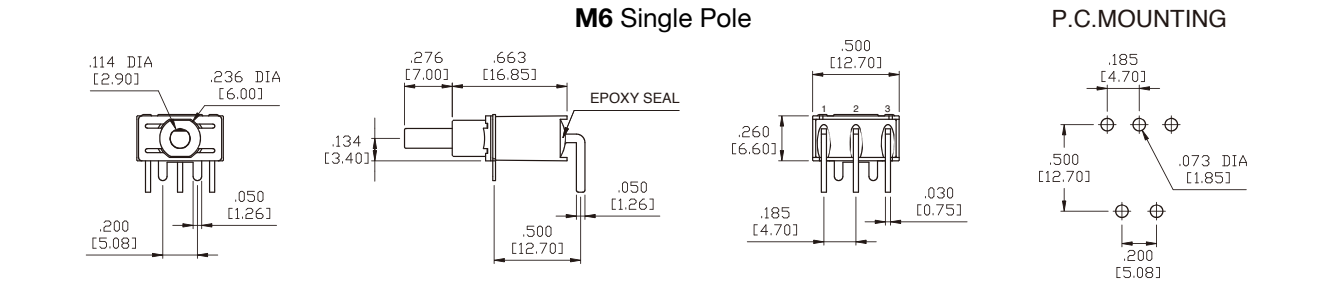
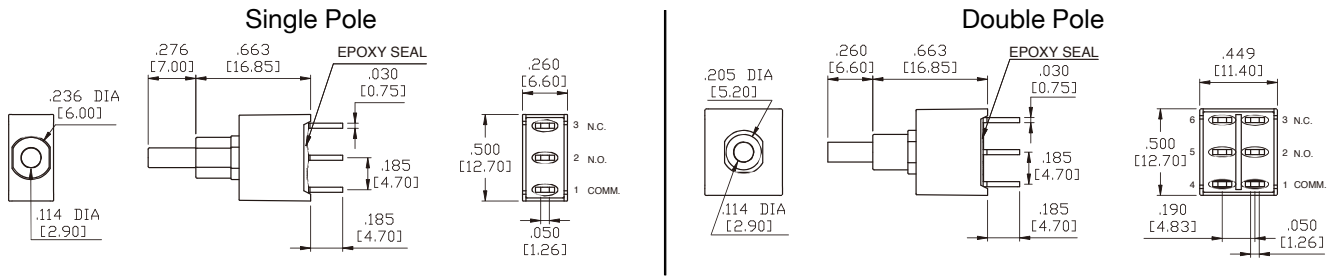

### Plunger Options

#### For B1 Bushing

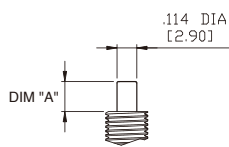

OPTION CODE	DIM. "A"
P1	.181 [4.60]
P2	.228 [5.80]
P3	.087 [2.20]

#### For B4 Bushing

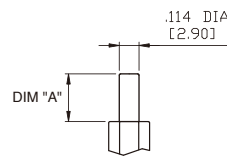

OPTION CODE	DIM. "A"
P1	.276 [7.00]
P2	.323 [8.20]
P3	.181 [4.60]

### Bushing Options

#### B1

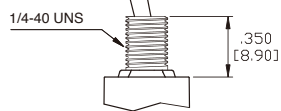

#### B4

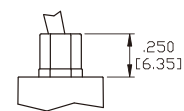

## 3MS-Series Dimensional Specifications: in. [mm]

### Termination Options

**M1**

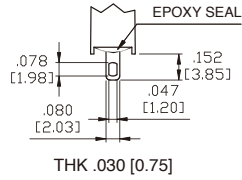

**M2**

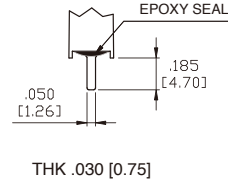

### M7 Single Pole

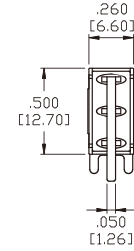
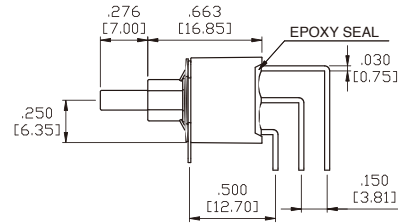
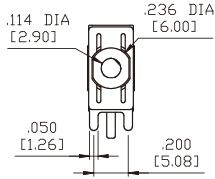

### P.C.MOUNTING

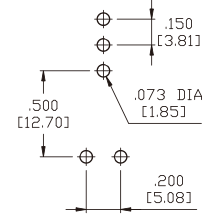

### M7 Double Pole

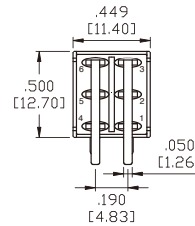
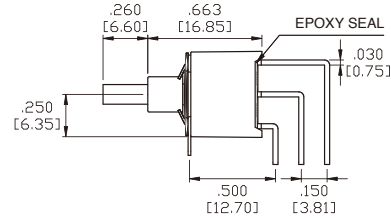
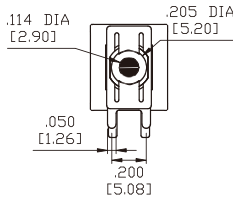

### P.C.MOUNTING

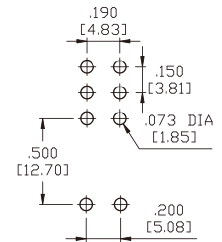

### VS2-VS3 Single Pole

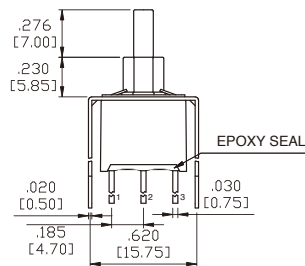
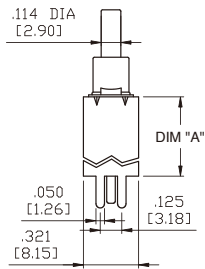

OPTION CODE	DIM. 'A'
<b>VS2</b>	.461 [11.70]
<b>VS3</b>	.630 [16.00]

### P.C.MOUNTING

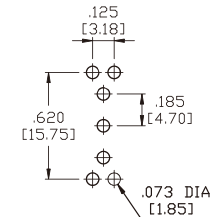

### VS2-VS3 Double Pole

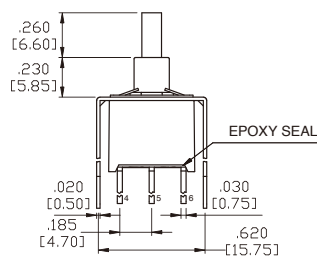
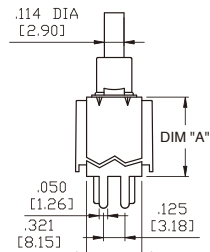

OPTION CODE	DIM. 'A'
<b>VS2</b>	.461 [11.70]
<b>VS3</b>	.630 [16.00]

### P.C.MOUNTING

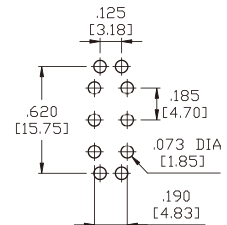



## 3MS-Series Dimensional Specifications: in. [mm]

### Termination Options

#### VS4-VS5 Single Pole

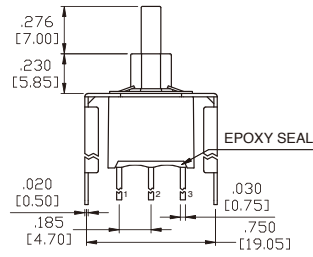
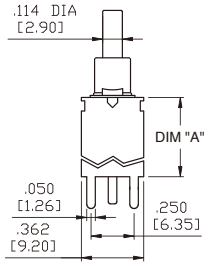

OPTION CODE	DIM. 'A'
VS4	.461 [11.70]
VS5	.630 [16.00]

#### P.C. MOUNTING

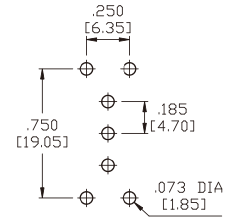

#### VS4-VS5 Double Pole

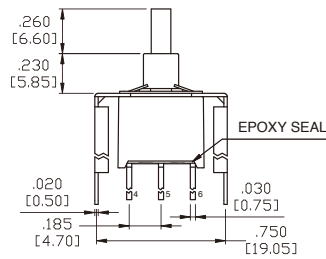
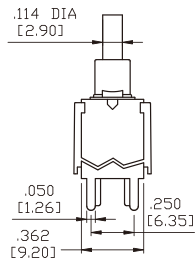

OPTION CODE	DIM. 'A'
VS4	.461 [11.70]
VS5	.630 [16.00]

#### P.C. MOUNTING

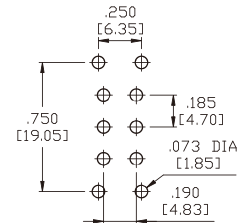

### Snap-In Termination Options

#### M61

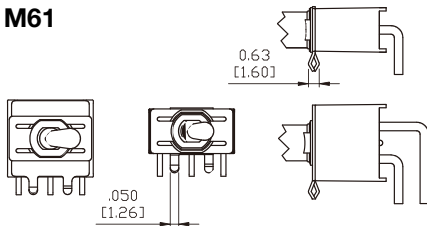

#### VS21, VS31

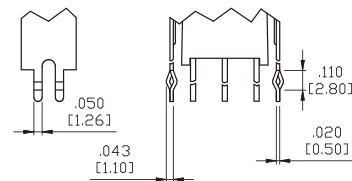

#### M71

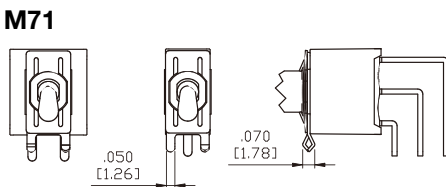

#### VS41, VS51

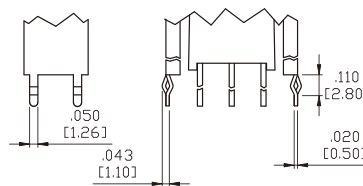

\* PC Mounting for M61, M71, VS21, VS31, VS41, VS51 refer to M6, M7, VS2, VS3, VS4, VS5 respectively.

## 3MN-Series Dimensional Specifications: in. [mm]

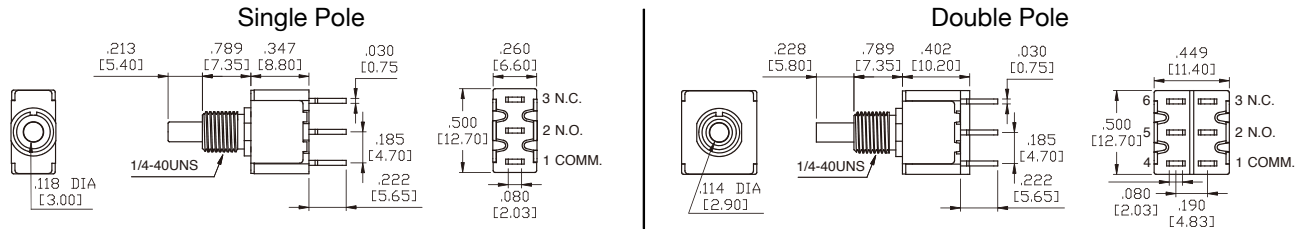

### Plunger Options

For B1, B2, B3, B4 Bushing

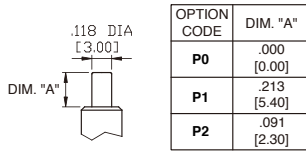

For B6 Bushing

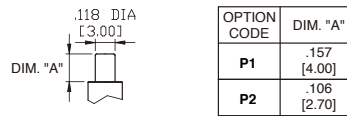

AP1

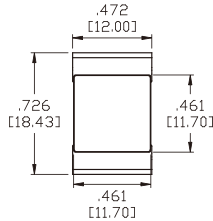

### Actuator Options for Snap-In Front Mount

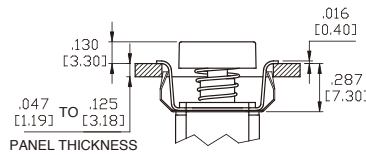

### PANEL MOUNTING

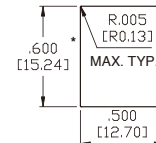

\* Increase this dimension to .620/.625 [15.75/15.88] for .091/.125 [2.31/3.18] thk. panels.

AP2 with Frame

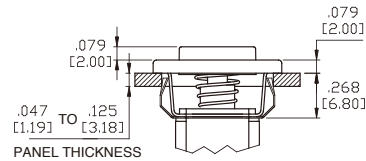
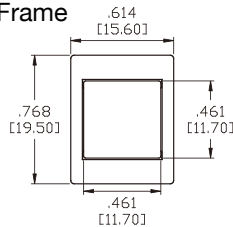

### PANEL MOUNTING

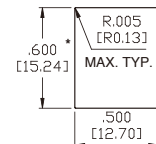

\* Increase this dimension to .620/.625 [15.75/15.88] for .091/.125 [2.31/3.18] thk. panels.

AP3 Flush CAP

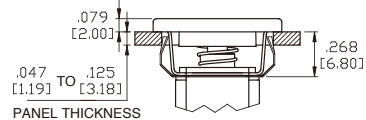
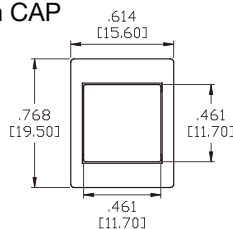

### PANEL MOUNTING

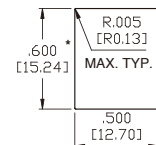

\* Increase this dimension to .620/.625 [15.75/15.88] for .091/.125 [2.31/3.18] thk. panels.

### Bushing Options

B1 Threaded Standard  
B2 Non-Threaded

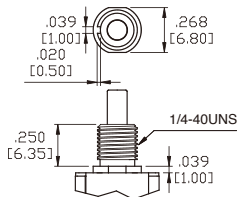

B3 Threaded Standard  
B4 Non-Threaded

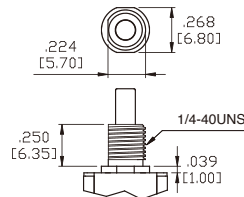

B6 Non-Threaded  
(FOR TERMINATION OPTIONS VS6-VS9 ONLY)

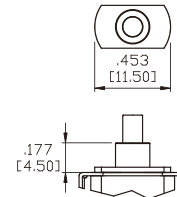

## 3MN-Series Dimensional Specifications: in. [mm]

### Termination Options

#### M1 Standard Solder Lug

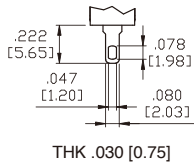

#### M2 PC Thru-Hole

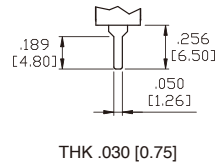

#### M5 Wire Wrap

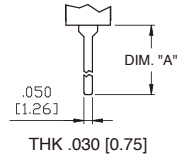

OPTION CODE	DIM. "A"
M5-1	.750 [19.05]
M5-2	.964 [24.48]
M5-3	.425 [10.80]

#### M6 Single Pole

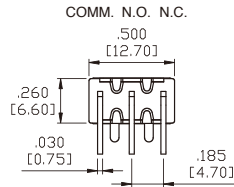
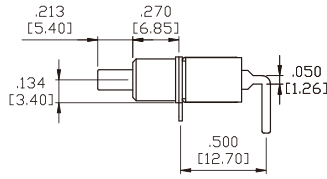
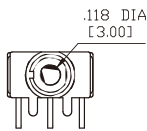

#### P.C.MOUNTING

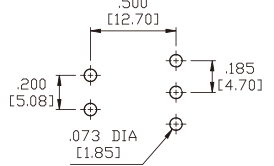

#### M6 Double Pole

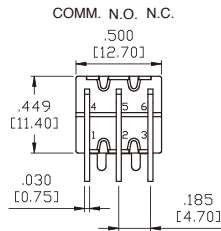
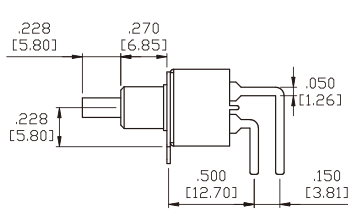
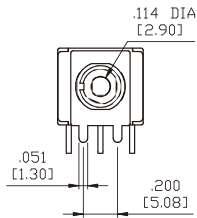

#### P.C.MOUNTING

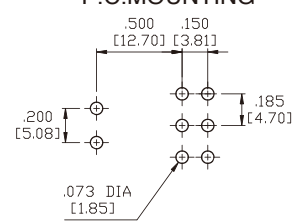

#### M7 Single Pole

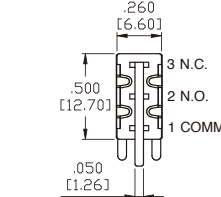
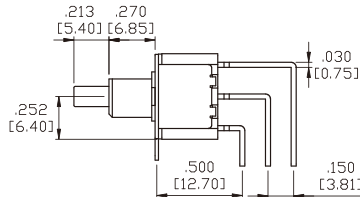
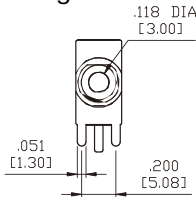

#### P.C.MOUNTING

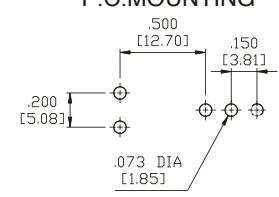

#### M7 Double Pole

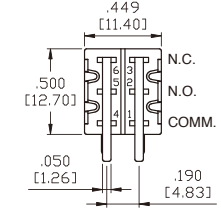
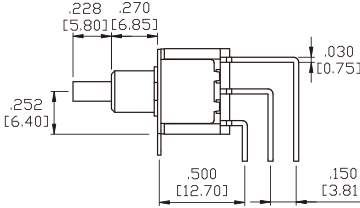
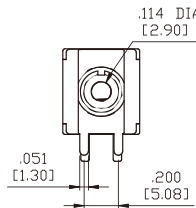

#### P.C.MOUNTING

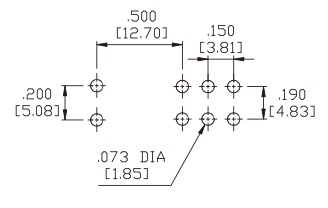

#### VS2-VS3 Single Pole

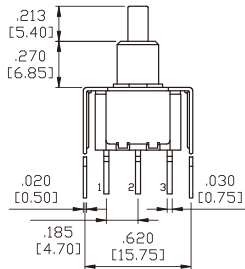
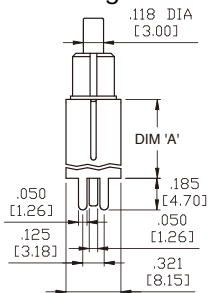

OPTION CODE	DIM. 'A'
VS2	.461 [11.70]
VS3	.630 [16.00]

#### P.C.MOUNTING

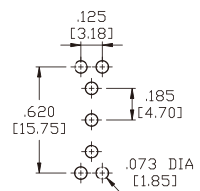

## 3MN-Series Dimensional Specifications: in. [mm]

### Termination Options

#### VS2-VS3 Double Pole

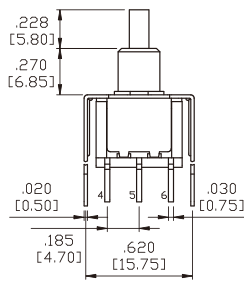
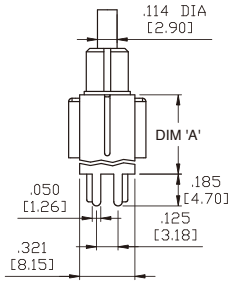

OPTION CODE	DIM.'A'
VS2	.461 [11.70]
VS3	.630 [16.00]

#### P.C.MOUNTING

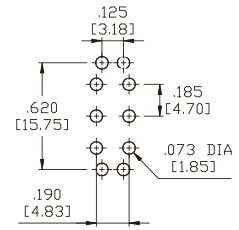

#### VS4-VS5 Single Pole

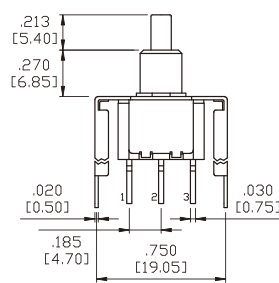
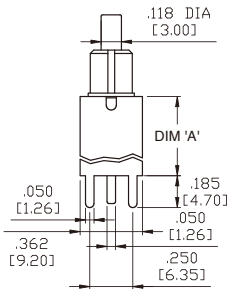

OPTION CODE	DIM.'A'
VS4	.461 [11.70]
VS5	.630 [16.00]

#### P.C.MOUNTING

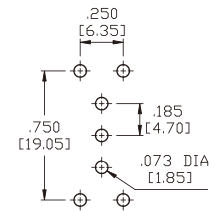

#### VS4-VS5 Double Pole

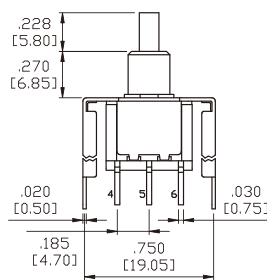
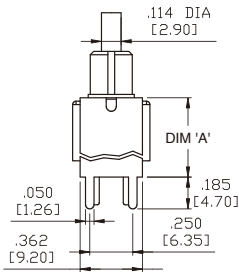

OPTION CODE	DIM.'A'
VS4	.461 [11.70]
VS5	.630 [16.00]

#### P.C.MOUNTING

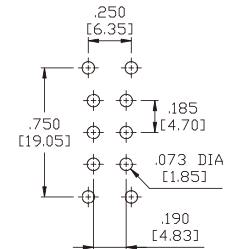

#### VS6-VS7 Single Pole

(FOR B6 BUSHING ONLY)

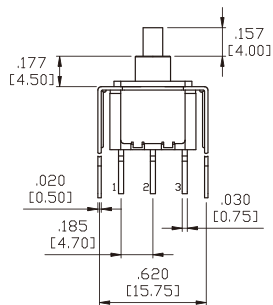
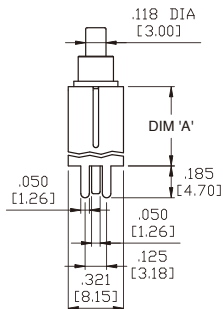

OPTION CODE	DIM.'A'
VS6	.461 [11.70]
VS7	.630 [16.00]

#### P.C.MOUNTING

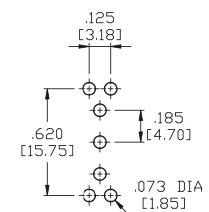

## 3MN-Series Dimensional Specifications: in. [mm]

### Termination Options

#### VS6-VS7 Double Pole (FOR B6 BUSHING ONLY)

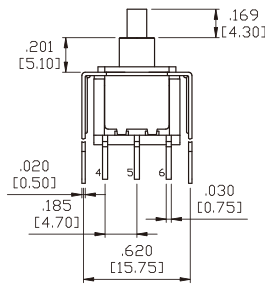
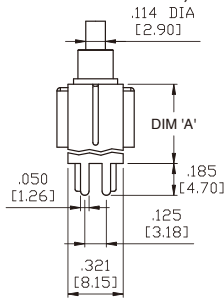

OPTION CODE	DIM. 'A'
VS6	.461 [11.70]
VS7	.630 [16.00]

#### P.C.MOUNTING

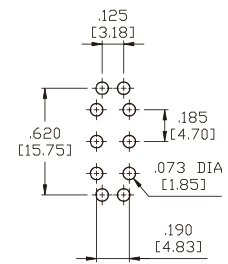

#### VS8-VS9 Single Pole (FOR B6 BUSHING ONLY)

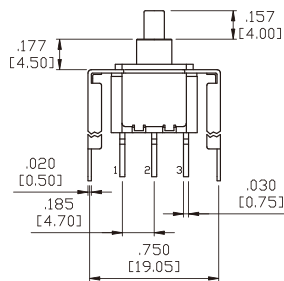
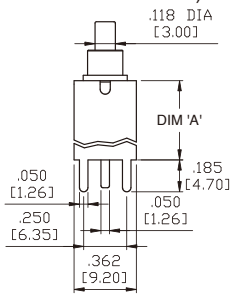

OPTION CODE	DIM. 'A'
VS8	.461 [11.70]
VS9	.630 [16.00]

#### P.C.MOUNTING

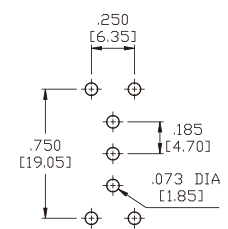

#### VS8-VS9 Double Pole (FOR B6 BUSHING ONLY)

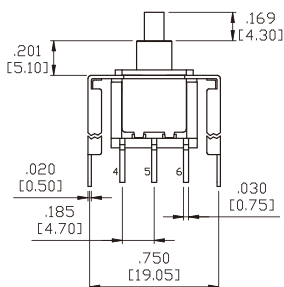
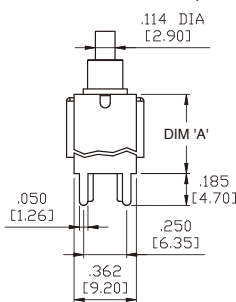

OPTION CODE	DIM. 'A'
VS8	.461 [11.70]
VS9	.630 [16.00]

#### P.C.MOUNTING

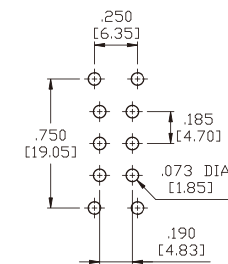

### Snap-In Termination Options

#### VS21, VS31

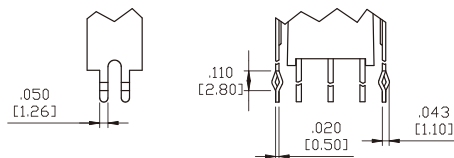

#### VS41, VS51

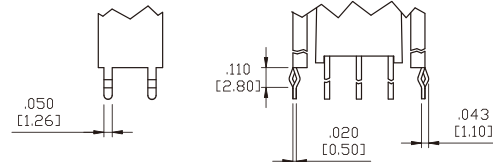

\* PC Mounting for VS21, VS31, VS41, VS51 refer to VS2, VS3, VS4, VS5 respectively.

## 3MA-Series Dimensional Specifications: in. [mm]

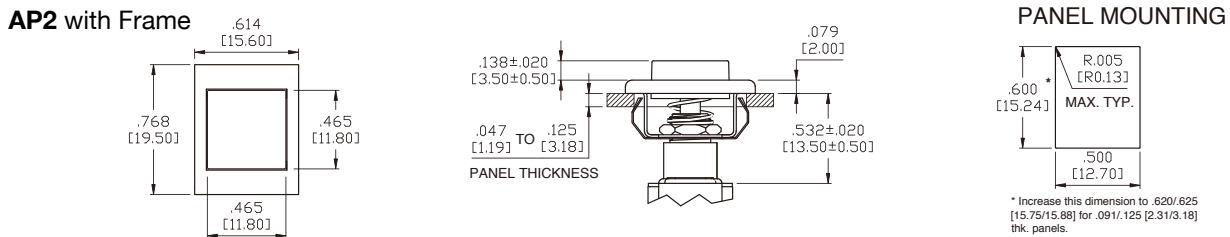
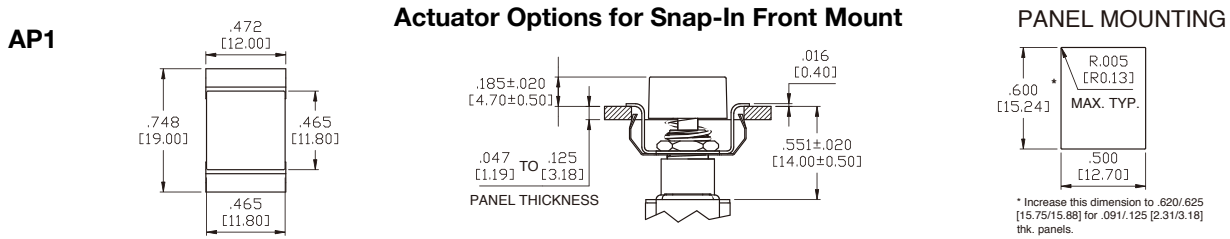
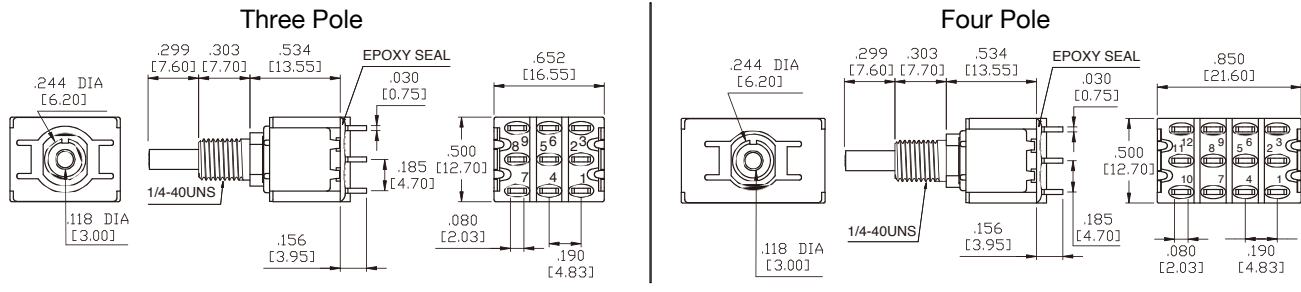
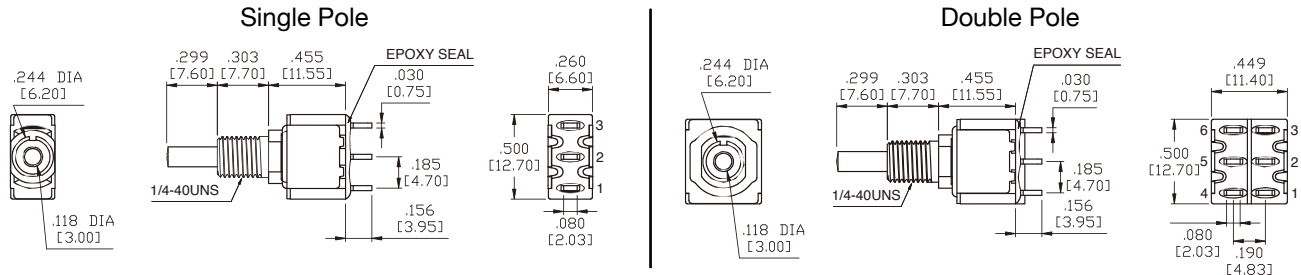

### Plunger Options

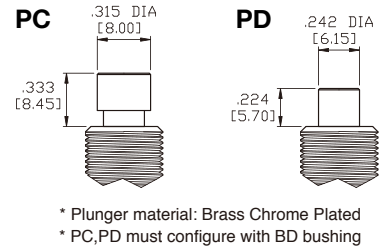
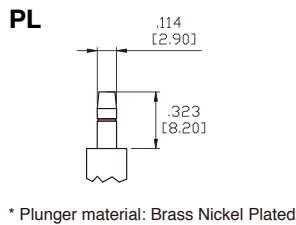
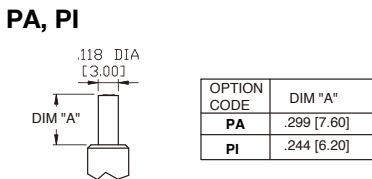

## 3MA-Series Dimensional Specifications: in. [mm]

### B10 Threaded Standard B20 Non-Threaded

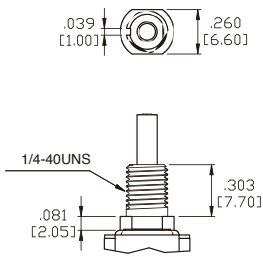

### Bushing Options

#### B21 Non-Threaded

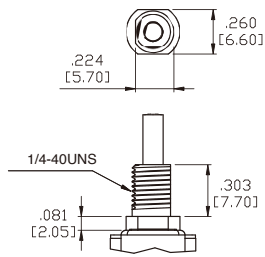

#### BD Threaded Standard

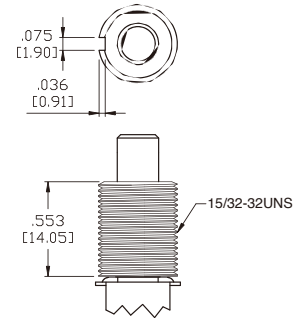

### Termination Options

#### M1 Standard Solder Lug

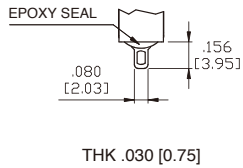

#### M2 PC Thru-Hole

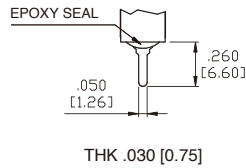

#### M5 Wire Wrap

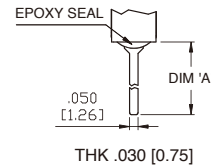

OPTION CODE	DIM. 'A'
M5-1	.750 [19.05]
M5-2	.964 [24.48]
M5-3	.425 [10.80]
M5-4	1.062 [26.97]

### M6 Single Pole

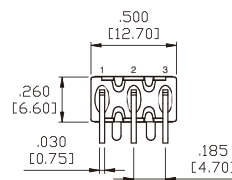
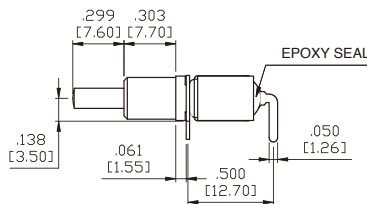
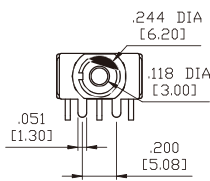

### P.C.MOUNTING

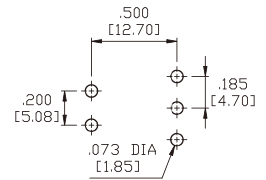

### M6 Double Pole

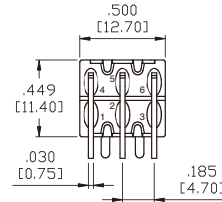
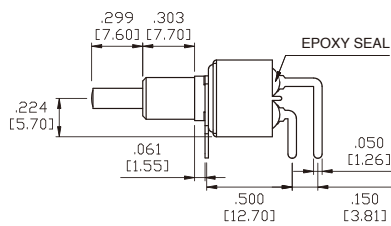
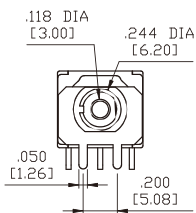

### P.C.MOUNTING

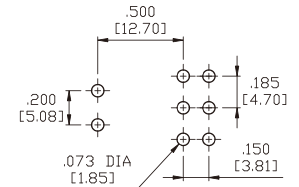

### M7 Single Pole

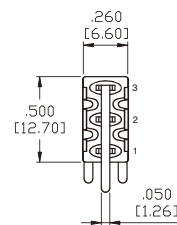
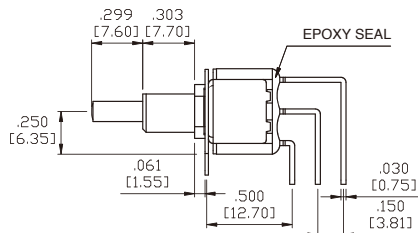
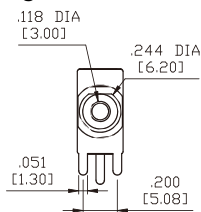

### P.C.MOUNTING

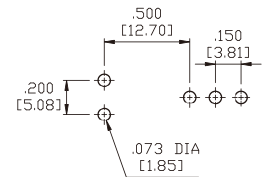

## 3MA-Series Dimensional Specifications: in. [mm]

### Termination Options

#### M7 Double Pole

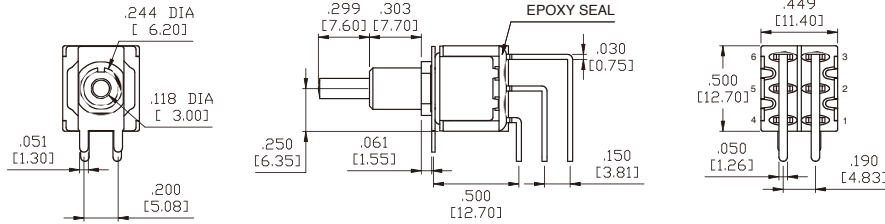

#### P.C.MOUNTING

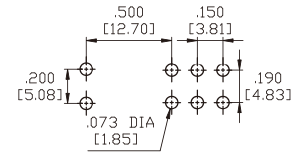

#### M7 Three Pole

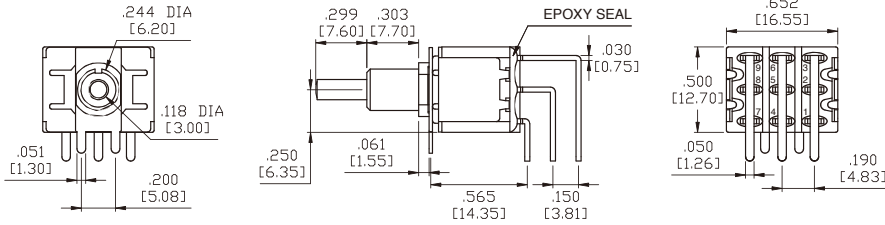

#### P.C.MOUNTING

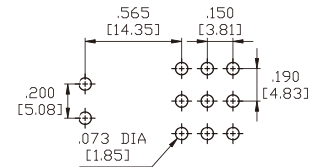

#### M7 Four Pole

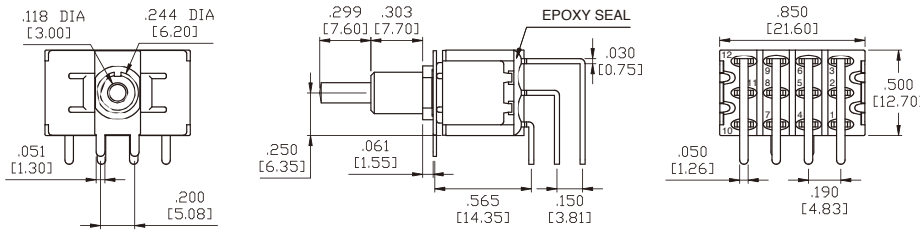

#### P.C.MOUNTING

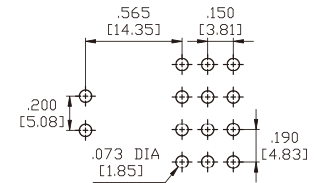

#### VS2-VS3 Single Pole

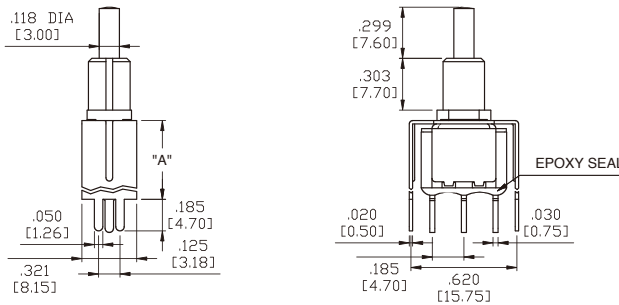

#### P.C.MOUNTING

OPTION CODE	DIM.'A'
VS2	.461 [11.70]
VS3	.630 [16.00]

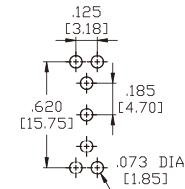

#### VS2-VS3 Double Pole

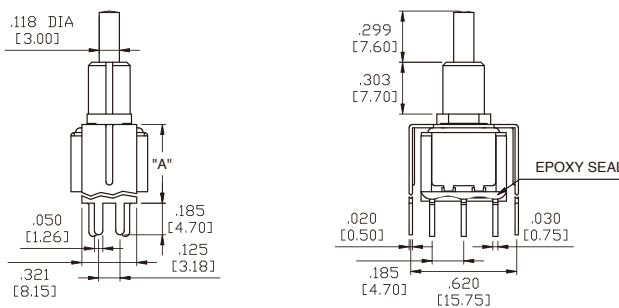

#### P.C.MOUNTING

OPTION CODE	DIM.'A'
VS2	.461 [11.70]
VS3	.630 [16.00]

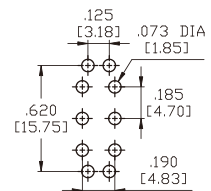



# 3MA-Series Dimensional Specifications: in. [mm]

## Termination Options

### VS4-VS5 Single Pole

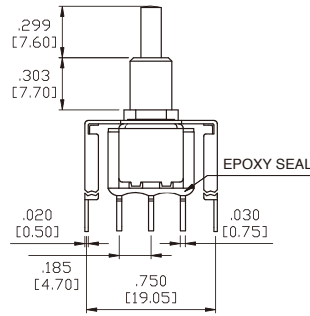
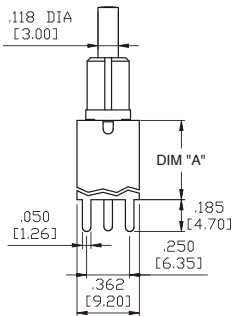

OPTION CODE	DIM.'A'
<b>VS4</b>	.461 [11.70]
<b>VS5</b>	.630 [16.00]

### P.C.MOUNTING

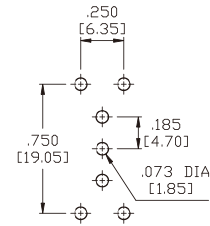

### VS4-VS5 Double Pole

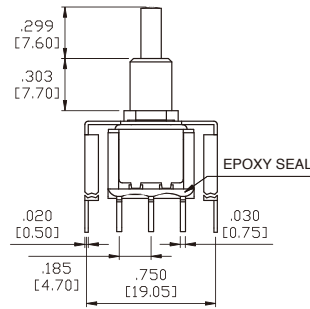
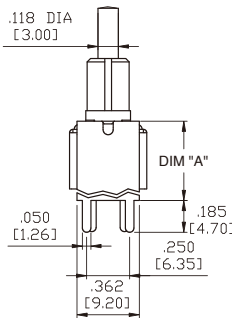

OPTION CODE	DIM.'A'
<b>VS4</b>	.461 [11.70]
<b>VS5</b>	.630 [16.00]

### P.C.MOUNTING

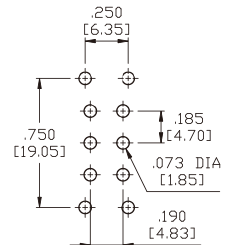

## Panel Mounting

### 1/4 INCH BUSHING

#### B10

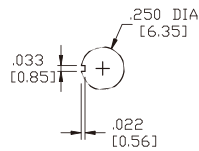

#### B20

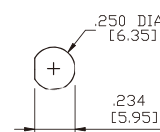

#### B21

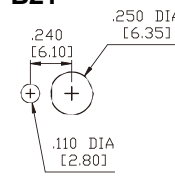

### 15/32 INCH BUSHING

#### BD

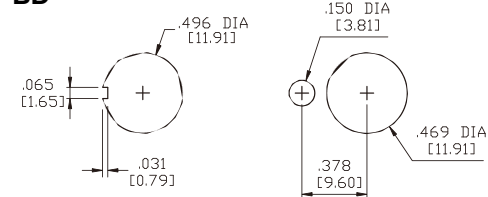

## Plunger Caps

#### C1

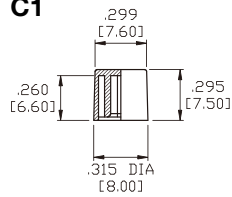

#### C2

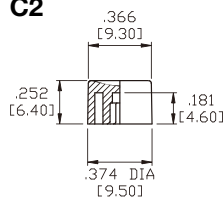

#### C3

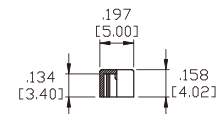
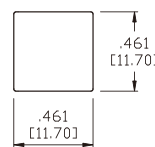

#### C5

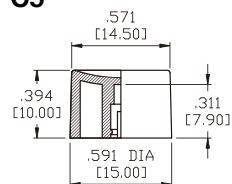

For PL plunger only

#### C6

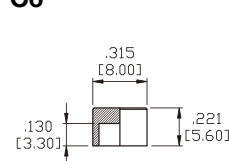

For PD plunger only

#### C7

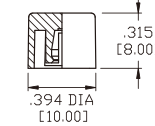

For PL plunger only

CAP AND FRAME COLORS			
1	White	6	Green
2	Black	7	Blue
3	Red	8	Brown
4	Orange	9	Gray
5	Yellow		

MATERIAL: ABS for C1~C5, C7  
MATERIAL: Chrome plated brass for C6

## Authorized Sales Representatives and Distributors

Click on a region of the map below to find your local representatives and distributors or visit [www.carlingtech.com/findarep](http://www.carlingtech.com/findarep).



## About Carling

Founded in 1920, Carling Technologies is a leading manufacturer of electrical and electronic switches and assemblies, circuit breakers, electronic controls, power distribution units, and multiplexed power distribution systems. With four ISO registered manufacturing facilities and technical sales offices worldwide, Carling Technologies Sales, Service and Engineering teams do much more than manufacture electrical components, they engineer powerful solutions! To learn more about Carling please visit [www.carlingtech.com/company-profile](http://www.carlingtech.com/company-profile).

To view all of Carling's environmental, quality, health & safety certifications please visit [www.carlingtech.com/environmental-certifications](http://www.carlingtech.com/environmental-certifications)

## **Worldwide Headquarters**

Carling Technologies, Inc.  
60 Johnson Avenue, Plainville, CT 06062  
**Phone:** 860.793.9281 **Fax:** 860.793.9231  
**Email:** sales@carlingtech.com

**Northern Region Sales Office:** nrsm@carlingtech.com  
**Southeast Region Sales Office:** sersm@carlingtech.com  
**Midwest Region Sales Office:** mrsm@carlingtech.com  
**West Region Sales Office:** wrsm@carlingtech.com  
**Latin America Sales Office:** larsm@carlingtech.com

## **Asia-Pacific Headquarters**

Carling Technologies, Asia-Pacific Ltd.,  
Suite 1607, 16/F Tower 2, The Gateway,  
Harbour City, 25 Canton Road,  
Tsimshatsui, Kowloon, Hong Kong  
**Phone:** Int + 852-2737-2277 **Fax:** Int + 852-2736-9332  
**Email:** sales@carlingtech.com.hk

**Shenzhen, China:** shenzhen@carlingtech.com  
**Shanghai, China:** shanghai@carlingtech.com  
**Pune, India:** india@carlingtech.com  
**Kaohsiung, Taiwan:** taiwan@carlingtech.com  
**Yokohama, Japan:** japan@carlingtech.com

## **Europe | Middle East | Africa Headquarters**

Carling Technologies LTD  
4 Airport Business Park, Exeter Airport,  
Clyst Honiton, Exeter, Devon, EX5 2UL, UK  
**Phone:** Int + 44 1392.364422 **Fax:** Int + 44 1392.364477  
**Email:** ltd.sales@carlingtech.com

**Germany:** gmbh@carlingtech.com  
**France:** sas@carlingtech.com



**Carling Technologies®**

Innovative Designs. Powerful Solutions.

## X-ON Electronics

Largest Supplier of Electrical and Electronic Components

*Click to view similar products for [Pushbutton Switches](#) category:*

*Click to view products by [Carling](#) manufacturer:*

Other Similar products are found below :

[LW1L-M1C10V-A](#) [LW2L-A1C20M-GD](#) [LW2L-M1C20M-A](#) [60324L](#) [M7E-HRN2](#) [67021K512](#) [67081K512X](#) [701PB580](#) [719-5504-000](#)  
[MDPSSGLFS](#) [810KSV30B](#) [FLT 2U EE 01A](#) [MML21KA3ABK](#) [MML23KA3AC05K-001](#) [MML23KW3AA01W](#) [8418K2](#) [8646AB6X718UL](#)  
[8646ABUL](#) [FSDWH](#) [9001KXRK](#) [9001T8BK](#) [9533CD4+U574+U4922](#) [1203MRA](#) [A22EM01S](#) [A595](#) [1202A6](#) [12037A2ULCSA](#) [1203A2UL](#)  
[ABD122N-B](#) [1211390004](#) [ABN111-Y](#) [ABN400-R](#) [1211500044](#) [1211580012](#) [1212MRA](#) [1232A6NF](#) [RA3CSH6A](#) [1241.1183.7047](#)  
[1241.2511](#) [1241.3428](#) [1223A2ULCSA](#) [1223MRA](#) [1232AX2119](#) [1241.1183.8000](#) [1241.1183.8029](#) [1241.2506](#) [1241.2606](#) [12MA6](#)  
[1301940184](#) [RELBARF6X10\(PLASTIC\)](#)