

Standard Features

- **Protection Level:** IP65
- **Technical:** Fits 56 Circuit Breaker Poles (14 per section)
Knockout Sidewalls and installed double membrane seals
Tinted Transparent Door
Multiple Enclosure Combination Option
- **UL Recognized**
- **Enclosure Materials:** Polystyrene or Polycarbonate
- **Door Material:** Polycarbonate
- **Gasket Material:** Polyurethane
- **Material**
- **Temperature Range:** Polystyrene
-40°C to 70°C (-40°F to 158°F)
Polycarbonate
-40°C to 120°C (-40°F to 248°F)
- **Color:** Light Gray
- **Included Accessories:** (5) DIN Rails, Cable Shield, Filler Strips, (4) Label Strips, (15) M20 Double Membrane Seals, (2) M25 Double Membrane Seals, (1) M32 Double Membrane Seals, (1) M40 Entry Spout
- **Accessories:** See section below



AK 56+1

Ordering Information	Cat. No.	Type	Length	Dimensions mm (in) Width	Height	Std. Pk.
Polystyrene						
Enclosure	737-456	AK56+1	900 mm (35.43 in)	300 mm (11.81 in)	142 mm (5.59 in)	1
Polycarbonate						
Enclosure	738-456	AKi56+1	900 mm (35.43 in)	300 mm (11.81 in)	142 mm (5.59 in)	1

Accessories

Ordering Information	Cat. No.	Type	Std. Pk.
Key Lock	706-102	KL2	1
Mounting Plate – 240 x 112 mm	795-001	MPI 1	1
Mounting Plate – 240 x 240 mm	795-002	MPI 2	1
Mounting Plate – 240 x 390 mm	795-003	MPI 3	1
Mounting Plate – 240 x 540 mm	795-004	MPI 4	1
DIN Rail - 216 mm Surface Mounted	795-030	NS35-216/3	1
Hinge Kit Set	190-005	HK2	1
Mounting Tab Kit (metal)	793-004	MT2	1
Filler Strip	799-012	108 mm piece (6 divisions)	1
2x27 Pole Ground/Neutral Terminal Strip (6 screw clamps 2.5-16mm ² , 21 spring clamps 1.5-4mm ² each)	790-327	AK28PE/N-SL	1

Please refer to pages 149-152 for additional accessories and detailed information.

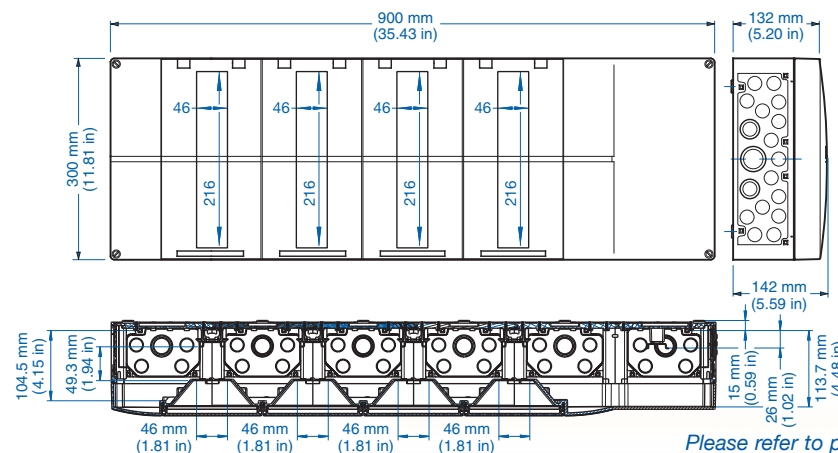

Please refer to page 158 for Knockout details.

X-ON Electronics

Largest Supplier of Electrical and Electronic Components

Click to view similar products for [Enclosures, Boxes, & Cases](#) category:

Click to view products by [Altech](#) manufacturer:

Other Similar products are found below :

[CR-425 PAINTED](#) [585-R-WH-PK](#) [M-10-PLATED](#) [60221-01](#) [60566-01-000](#) [HPL-9VB BATT DOOR](#) [M-16-LID-PLATED](#) [M18-PLTD](#) [M-21-LID-PLATED](#) [M-21-PLATED](#) [M-23-PLATED](#) [CU-281-MB](#) [6711GSKT](#) [71884-29-028](#) [LH45-100 Black](#) [7200B](#) [72868-510-000](#) [CNS-0000 Black](#) [72883-510-000](#) [CNS-0101 Black](#) [72906-510-000](#) [CNS-0407 Black](#) [73091-510-000](#) [CNM-0000-BLACK Kit](#) [73092-510-000](#) [CNM-0101 Black](#) [73108-510-000](#) [CNL-0303 Black](#) [73395-510-039](#) [CNS-0006 Bone](#) [74257-510-000](#) [CNL-0004](#) [MDC-1183-PLAIN-ALUM](#) [MDC-1183-PTD](#) [MDC-13104-PLAIN-ALUM](#) [MDC-211 - PAINTED IVORY/BEIGE](#) [MDC-321-PTD](#) [MDC-432-PLAIN-ALUM](#) [MDC-973-PTD](#) [76](#) [77153-01-028](#) [FLX6030](#) [83535-01-508](#) [PS-11296-G](#) [PS-11298-B](#) [116-508](#) [120-407](#) [120-412](#) [120-909](#) [120-455](#) [R272-100-000](#) [120-910](#) [R501-001-010](#) [R508-080-000](#) [R508-160-000](#) [R530-120-000](#) [R530-122-000](#) [R530-200-000](#) [R531-160-000](#) [R531-200-000](#) [R582-080-100](#)