

THIS COPY IS PROVIDED ON A RESTRICTED BASIS AND IS NOT TO BE USED IN ANY WAY DETRIMENTAL TO THE INTERESTS OF PANDUIT CORP.

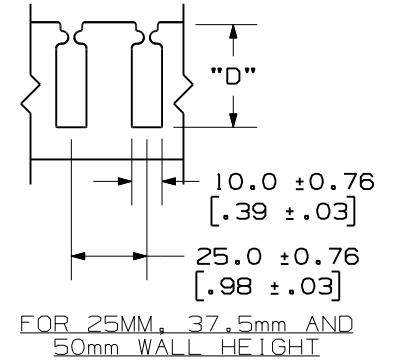
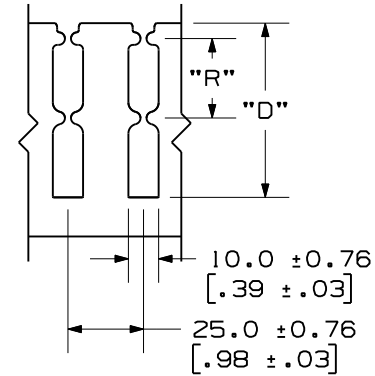
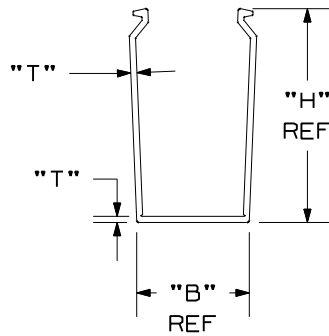
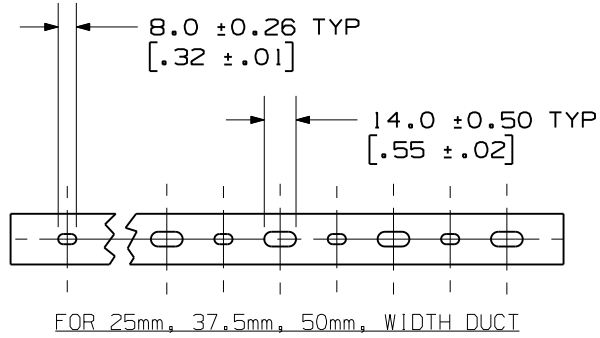

FOR 75mm AND 100mm WALL HEIGHT

SIDE WALL DIMENSIONS

NOTES:

- "B" MEASURED AT BASE.
- STANDARD LENGTH: 2.004 METER.
- SEE CURRENT CATALOG FOR PART NUMBER DESIGNATIONS FOR TYPE, COLOR, AND LENGTH.
- DUCT TYPE "TNC" PACKAGED WITH TYPE "TNC" COVER.
- DIMENSIONS ARE METRIC (INCHES).

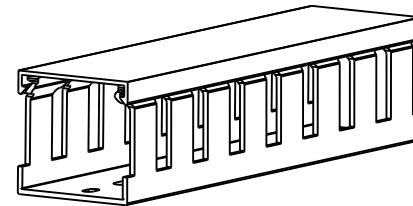
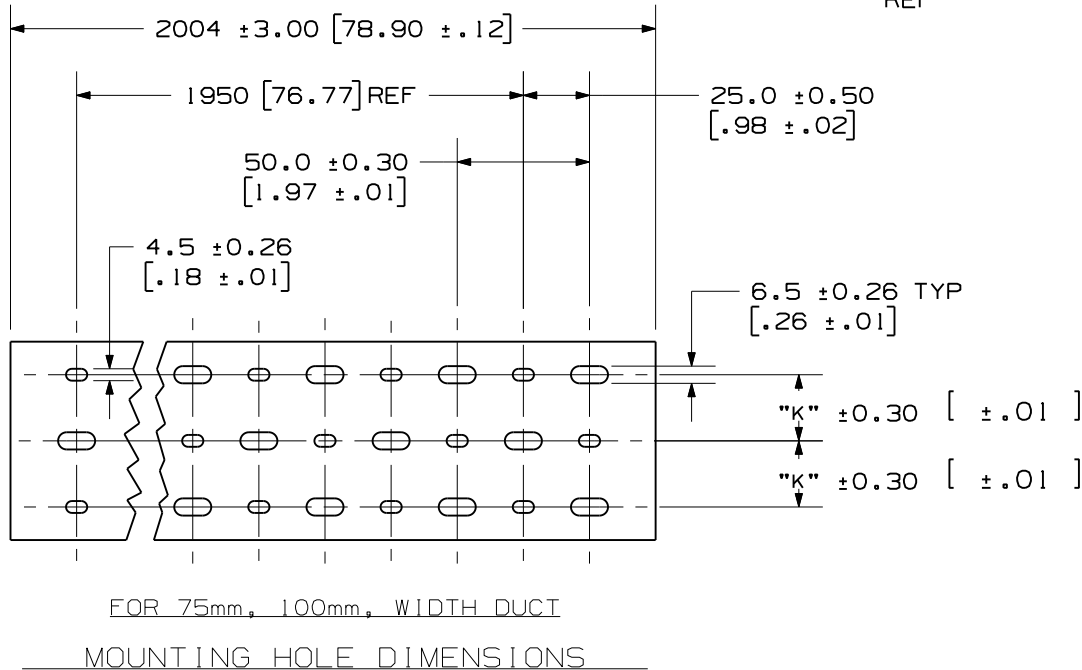

CHANNEL EXAMPLE:
TNC 37 X 50 LG 2
TYPE 37mm WIDE 50mm HIGH
COLOR (LIGHT GRAY) LENGTH (m)

TITLE		WIRING DUCT AND COVER		
		TYPE "TNC" METRIC		
		CUSTOMER DRAWING		
ITEM REVISION				
DATASET FILE NAME		D38539AG_DC_TNC/00A		
UNLESS OTHERWISE SPECIFIED, DIMENSIONAL TOLERANCES ARE: mm (IN)		MATERIAL: LOW-SMOKE HALOGEN-FREE MODIFIED PPE-HIPS BLEND		
.x : 2.54 (.1)		.xxx : .127 (.005)		
.xx : .25 (.01)		ANGLES : 5 °		
DRAWN BY		THIRD ANGLE PROJECTION		DRAWING NUMBER:
DATE				38539AG-DC
CHK		SCALE		SHT 1 OF 3
MRJS		NONE		SIZE
REV		A		

1	2/1/12	JCST	MRJS	RAMI	A. CORRECTED "T" DIMENSION (SHT 2) (25X37, 25X75, 50X100, 100X75, 100X100)	38539AG-DC
R	11/7/11	JCST	MRJS	RAMI	DRAWING RELEASED TO PRODUCTION	38539AG-DC
REV	DATE	BY	CHK	APR	DESCRIPTION	ECN

D10100DA/08

THIS COPY IS PROVIDED ON A RESTRICTED BASIS AND IS NOT TO BE USED IN ANY WAY DETRIMENTAL TO THE INTERESTS OF PANDUIT CORP.

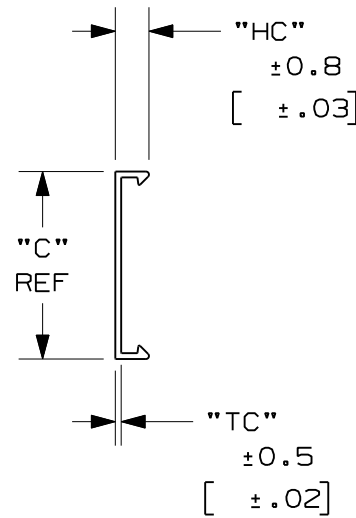
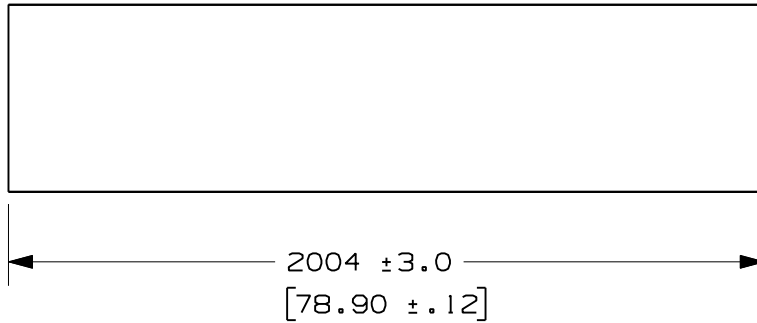

NOMINAL DUCT SIZE (W)	C REF	HC	TC
25	24.6 (.97)	8.9 (.35)	1.30 (.05)
37	37.1 (1.46)	8.9 (.35)	1.30 (.05)
50	49.6 (1.95)	8.9 (.35)	1.40 (.06)
75	74.6 (2.94)	9.4 (.37)	1.40 (.06)
100	99.6 (3.92)	9.4 (.37)	1.40 (.06)

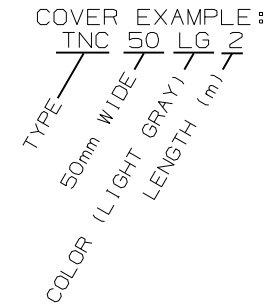

ALL DIMENSIONS ARE MM (IN).

REV	DATE	BY	CHK	APR	DESCRIPTION	ECN
1	2/1/12	JCST	MRJS	RAMI	SEE SHEET 1 FOR REVISIONS	38539AG-DC
R	11/7/11	JCST	MRJS	RAMI	SEE SHEET 1 FOR REVISIONS	38539AG-DC

TITLE WIRING DUCT AND COVER TYPE "TNC" METRIC CUSTOMER DRAWING					
ITEM REVISION					
DATASET FILE NAME D38539AG_DC_TNC/00A					
UNLESS OTHERWISE SPECIFIED, DIMENSIONAL TOLERANCES ARE: mm (IN) .x : 2.54 (.1) .xxx : .127 (.005) .xx : .25 (.01) ANGLES : 5 °				MATERIAL: LOW-SMOKE HALOGEN-FREE MODIFIED PPE-HIPS BLEND	
THIRD ANGLE PROJECTION				DRAWING NUMBER: 38539AG-DC	
DRAWN BY JCST	DATE 10/24/11	CHK MRJS	SCALE NONE	SHT 3 OF 3	
					SIZE A

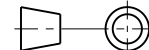

D10100DA/08

X-ON Electronics

Largest Supplier of Electrical and Electronic Components

Click to view similar products for [Wire Ducting](#) category:

Click to view products by [Panduit](#) manufacturer:

Other Similar products are found below :

[66200A-10](#) [CVED32VEPG](#) [CVED40VEPG](#) [F512D5-5F140Y](#) [F512D5-5F200Y](#) [F512D5-5F26Y](#) [F512D5-5F30Y](#) [F512D5-5F33Y](#) [F512D5-5F34Y](#) [F512D5-5F45Y](#) [F512D5-5F50Y](#) [F512D5-5F54Y](#) [F512D5-5F66Y](#) [F512D5-5F70Y](#) [F512D5-5F75Y](#) [F512D5-5F90Y](#) [F612D5-5F100Y](#) [F612D5-5F130Y](#) [F612D5-5F50Y](#) [F612D5-5F56Y](#) [F612D5-5F58Y](#) [F6L12D5-5F46](#) [F912D5-5F11Y](#) [F912D5-5F170Y](#) [F912D5-5F175Y](#) [F912D5-5F230Y](#) [F912D5-5F300Y](#) [F912D5-5F55Y](#) [F912D5-5F56Y](#) [F912D5-5F63Y](#) [F912D5-5F6Y](#) [F912D5-5F75Y](#) [F912D5-5F85Y](#) [F912D5-5F86Y](#) [F912D5-5F88Y](#) [F912D5-5F96Y](#) [FAP0047WBLMTP](#) [FAP12WBRDRDDLZ](#) [FAP12WDYLYLDLZ](#) [FAP12WEORORDLZ](#) [FAP6WEORORDLZ](#) [FAP6WFDBDBDLZ](#) [FAP8WEORORDLZ](#) [FCE2UWCL](#) [800A-LB](#) [802A-ECSP](#) [802I-ICSP](#) [FJQADH](#) [FJQFXT](#) [PED10](#)