

THIS COPY IS PROVIDED ON A RESTRICTED BASIS AND IS NOT TO BE USED IN ANY WAY DETRIMENTAL TO THE INTERESTS OF PANDUIT CORP.

PANDUIT PART NUMBER	WEIGHT
 WG24FRTB**	5.07 LBS/EACH (2299.7 g/EACH)

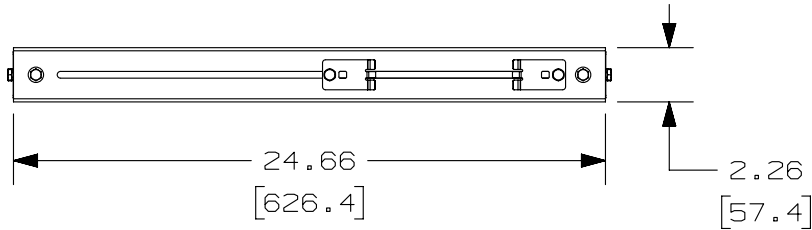

- NOTE:**
- PANDUIT PART NUMBER WG24FRTB** INCLUDES:
 - ONE (1) WYR-GRID 24" WIDTH FIBERRUNNER TRAPEZE BRACKET ASSEMBLY FOR 4X4 AND 6X4.
 - TWO (2) WYR-GRID FIBERRUNNER TRAPEZE UPRIGHT SUPPORT BRACKET ASSEMBLIES.
 - TWO (2) 1/4-20 X 3/4 HEX HEAD CAP SCREWS.
 - FOUR (4) 1/4 -20 HELICAL SPRING LOCKWASHERS.
 - TWO (2) 1/4-20 SAE FLAT WASHER.
 - TWO (2) 1/4-20 X 1-1/8 HEX HEAD CAP SCREWS.
 - TWO (2) WYR-GRID INTEGRAL BRACKET LOWER CLIP ASSEMBLIES.
 - DIMENSIONS IN PARENTHESES ARE METRIC.
 - PROVIDES ABILITY TO MOUNT FIBERRUNNER 6.6" TO 9.9" ABOVE WYR-GRID.
 - SEE CATALOG FOR ADDITIONAL PART SUFFIXES TO INDICATE PART FINISH AND/OR PACKAGE QUANTITY.

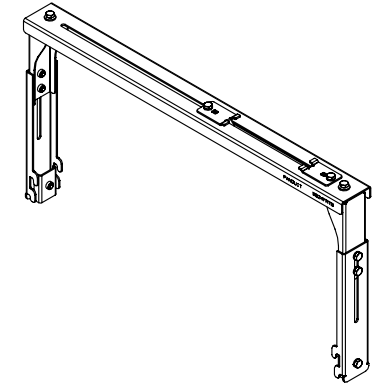
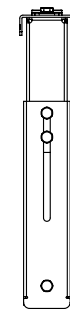
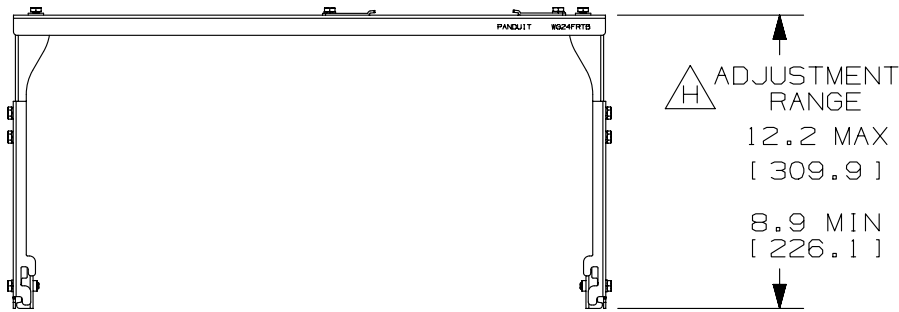

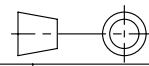

REV	DATE	BY	CHK	APR	DESCRIPTION	ECN
4	09-06-13	SSP	KMC	RN	I. REVISED INTEFRAL TO INTEGRAL ON NOTE 1.G	10D166AH-DC
3	04-05-13	SSP	DWR	RN	RELEASED TO PRODUCTION H. REVISED THE ADJUSTMENT RANGE TOLERANCES G. ADDED '**' SUFFIX TO PANDUIT PART NUMBER F. ADDED NOTE #4 TO GENERAL NOTES E. REMOVED PRIOR NOTE(S)	10D166AH-DC

TITLE						
WYR-GRID 24" WIDTH FIBERRUNNER TRAPEZE BRACKET FOR 4X4 AND 6X4 (WG24FRTB**) 						
CUSTOMER DRAWING						
ITEM REVISION NAME						
10D166AH/03.PRT						
DATASET FILE NAME						
10D166AH_DC/03E WG24FRTB**.PRT						
UNLESS OTHERWISE SPECIFIED, DIMENSIONAL TOLERANCES ARE: IN [mm]						
.X ±		.XXX ±				
.XX ± .05 [1.3]		ANGLES ±				
			THIRD ANGLE PROJECTION			
DRAWN BY	DATE	CHK	SCALE	DRAWING NUMBER:		
ERK	06-17-11	DWR	NONE	10D166AH-DC		
SHT 1 OF 1				SIZE		
				A		

2

1

D10100DA/11

X-ON Electronics

Largest Supplier of Electrical and Electronic Components

Click to view similar products for [Wire Ducting](#) category:

Click to view products by [Panduit](#) manufacturer:

Other Similar products are found below :

[66200A-10](#) [CVED32VEPG](#) [CVED40VEPG](#) [F512D5-5F140Y](#) [F512D5-5F200Y](#) [F512D5-5F26Y](#) [F512D5-5F30Y](#) [F512D5-5F33Y](#) [F512D5-5F34Y](#) [F512D5-5F45Y](#) [F512D5-5F50Y](#) [F512D5-5F54Y](#) [F512D5-5F66Y](#) [F512D5-5F70Y](#) [F512D5-5F75Y](#) [F512D5-5F90Y](#) [F612D5-5F100Y](#) [F612D5-5F130Y](#) [F612D5-5F50Y](#) [F612D5-5F56Y](#) [F612D5-5F58Y](#) [F6L12D5-5F46](#) [F912D5-5F11Y](#) [F912D5-5F170Y](#) [F912D5-5F175Y](#) [F912D5-5F230Y](#) [F912D5-5F300Y](#) [F912D5-5F55Y](#) [F912D5-5F56Y](#) [F912D5-5F63Y](#) [F912D5-5F6Y](#) [F912D5-5F75Y](#) [F912D5-5F85Y](#) [F912D5-5F86Y](#) [F912D5-5F88Y](#) [F912D5-5F96Y](#) [FAP0047WBLMTP](#) [FAP12WBRDRDDLZ](#) [FAP12WDYLYLDLZ](#) [FAP12WEORORDLZ](#) [FAP6WEORORDLZ](#) [FAP6WFDBDBDLZ](#) [FAP8WEORORDLZ](#) [FCE2UWCL](#) [800A-LB](#) [802A-ECSP](#) [802I-ICSP](#) [FJQADH](#) [FJQFXT](#) [PED10](#)