

Type EP Series

Key Features

- Power up to 10W in Small Size
- 16 Size / Power Options
- Specially Designed and Tested for Surge Immunity
- Flame Resistant Coating

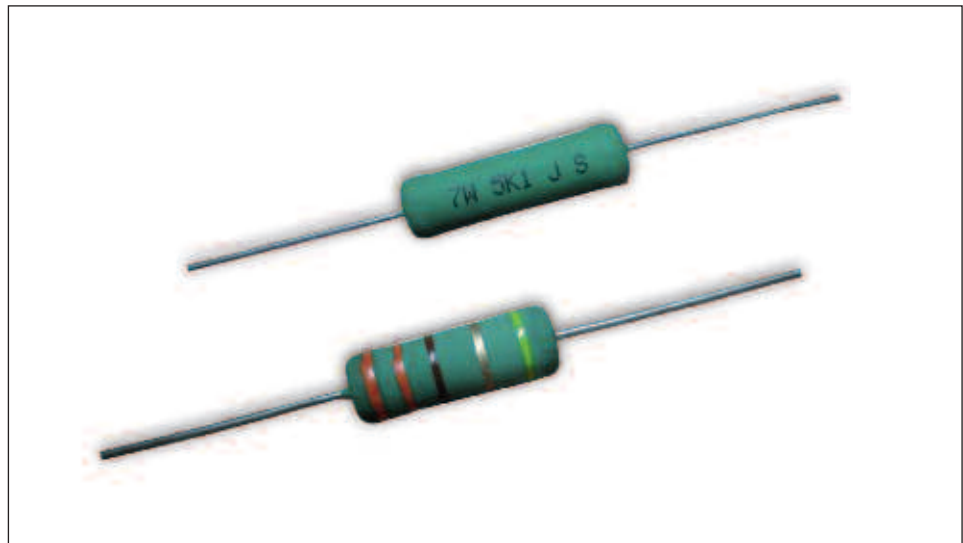

TE Connectivity is pleased to offer this wire wound axial leaded resistor. Robustly manufactured with high quality materials this resistor offers flame proof coating, and is designed and tested to withstand power surges of up to 12KV.

Characteristics – Electrical

	Type	Rated Power at 70° C	Max. Working Voltage	Max. Overload Voltage	Dielectric Withstanding Voltage	Resistance Range	Operating Temp. Range
Normal size	EP05W	1/2W (0.50W)	500 V	1,000 V	350 V	10Ω–560Ω	-55°C – +155°C
	EP1W	1W	500 V	1,000 V	500 V	10Ω–1KΩ	
	EP2W	2W	500 V	1,000 V	500 V	10Ω–2KΩ	
	EP3W	3W	500 V	1,000 V	500 V	10Ω–3KΩ	
	EP5W	5W	500 V	1,000 V	500 V	10Ω–5KΩ	
	EP7W	7W	500 V	1,000 V	500 V	10Ω–6KΩ	
	EP8W	8W	500 V	1,000 V	500 V	10Ω–10KΩ	
	EP9W	9W	500 V	1,000 V	500 V	10Ω–15KΩ	
	Small size	EP1WS	1W	500 V	1,000 V	500 V	
EP2WS		2W	500 V	1,000 V	500 V	10Ω–1KΩ	
EP3WS		3W	500 V	1,000 V	500 V	10Ω–2KΩ	
EP5WS		5W	500 V	1,000 V	500 V	10Ω–3KΩ	
EP7WS		7W	500 V	1,000 V	500 V	10Ω–5KΩ	
EP8WS		8W	500 V	1,000 V	500 V	10Ω–6KΩ	
EP9WS		9W	500 V	1,000 V	500 V	10Ω–10KΩ	
EP10WS		10W	500 V	1,000 V	500 V	10Ω–15KΩ	

Power Derating Curve

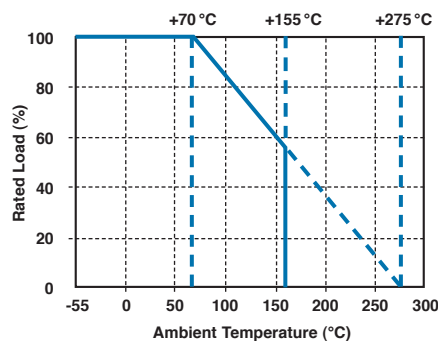

For resistors operated in ambient temperatures above 70°C, power rating must be derated in accordance with this curve.

Type EP Series

Surge Rating

Type	Low Resistance Range	Maximum Surge Voltage	Medium Resistance Range	Maximum Surge Voltage	High Resistance Range	Maximum Surge Voltage
EP05W	10Ω – 40Ω	3KV	43Ω – 240Ω	4kV	270Ω – 560Ω	4kV
EP1W	10Ω – 50Ω	4KV	51Ω – 240 Ω	5kV	270Ω – 1kΩ	5kV
EP2W	10Ω – 100Ω	5KV	110Ω – 240Ω	6kV	270Ω – 2kΩ	6kV
EP3W	10Ω – 100Ω	7KV	110Ω – 680Ω	8kV	750Ω – 3kΩ	8kV
EP5W	10Ω – 160Ω	8KV	180Ω – 680Ω	9kV	750Ω – 5kΩ	9kV
EP7W	10Ω – 160Ω	9KV	180Ω – 680Ω	10kV	750Ω – 6kΩ	10kV
EP8W	10Ω – 160Ω	10KV	180Ω – 680Ω	11kV	750Ω – 10kΩ	11kV
EP9W	10Ω – 160Ω	10KV	180Ω – 680Ω	11kV	750Ω – 15kΩ	12kV
Small Size						
EP1WS	10Ω – 40Ω	3KV	43Ω – 240Ω	4kV	270Ω – 560Ω	4kV
EP2WS	10Ω – 50Ω	4KV	51Ω – 240 Ω	5kV	270Ω – 1kΩ	5kV
EP3WS	10Ω – 100Ω	5KV	110Ω – 240Ω	6kV	270Ω – 2kΩ	6kV
EP5WS	10Ω – 100Ω	7KV	110Ω – 680Ω	8kV	750Ω – 3kΩ	8kV
EP7WS	10Ω – 160Ω	8KV	180Ω – 680Ω	9kV	750Ω – 5kΩ	9kV
EP8WS	10Ω – 160Ω	9KV	180Ω – 680Ω	10kV	750Ω – 6kΩ	10kV
EP9WS	10Ω – 160Ω	10KV	180Ω – 680Ω	11kV	750Ω – 10kΩ	11kV
EP10WS	10Ω – 160Ω	10KV	180Ω – 680Ω	11kV	750Ω – 15kΩ	12kV

Surge Waveform (1.2/50 μs)

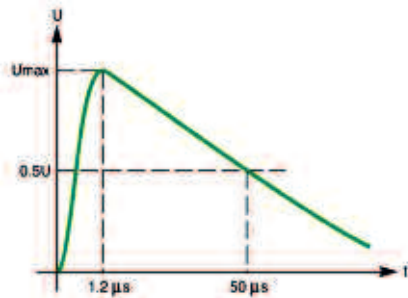

1.2/50 μs Voltage Capability

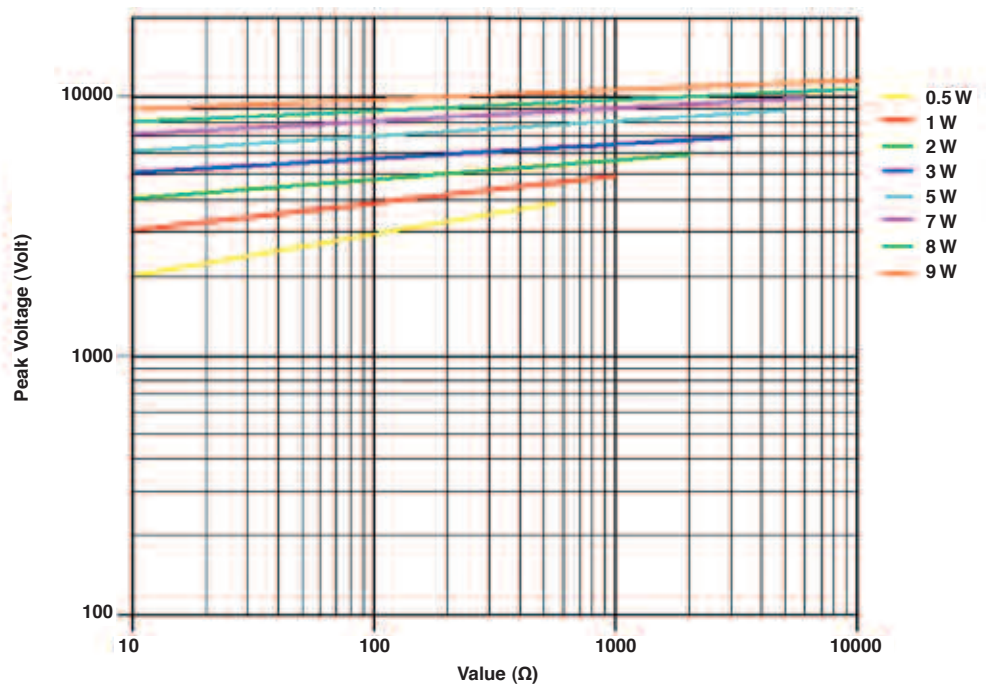

Type EP Series

Construction

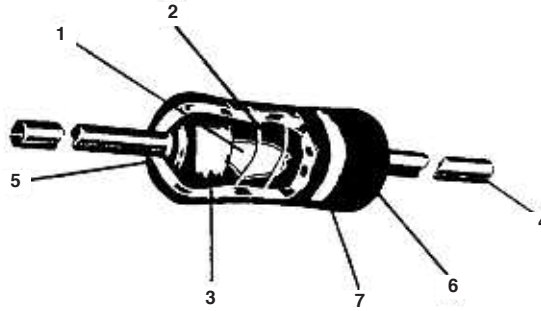

No.	Name	Material
1	Basic Body	Rod Type Ceramics
2	Resistance Wire	Ni-Cr Alloy, Cu-Ni Alloy
3	End Cap	Steel (Tin plated iron surface)
4	Lead Wire	Annealed copper wire coated with tin
5	Joint	By welding
6	Coating	Insulated & Non-Flame paint (Color: Light Green)
7	Color Code	Non-Flame epoxy resin

Dimensions



Part No.	Power Rating at 70 °C	Dimension (mm)			
		D ± 1	L ± 1	d ± 0.05	H ± 3
EP05W	1/2W (0.50W)	3.5	10.0	0.54	28
EP1W	1W	5.0	12.0	0.70	25
EP2W	2W	5.5	16.0	0.70	28
EP3W	3W	6.5	17.5	0.75	28
EP5W	5W	8.5	25.0	0.75	38
EP7W	7W	8.5	30.0	0.75	38
EP8W	8W	8.5	40.0	0.75	38
EP9W	9W	8.5	53.0	0.75	38
EP1WS	1W-S	3.5	10.0	0.54	28
EP2WS	2W-S	5.0	12.0	0.70	25
EP3WS	3W-S	5.5	16.0	0.70	28
EP5WS	5W-S	6.5	17.5	0.75	28
EP7WS	7W-S	8.5	25.0	0.75	38
EP8WS	8W-S	8.5	30.0	0.75	38
EP9WS	9W-S	8.5	40.0	0.75	38
EP10WS	10W-S	8.5	53.0	0.75	38

Type EP Series

Characteristics – Environmental

Item	Limits	Test Method (JIS C 5201-1)
Temperature Coefficient of Resistance (TCR):	<20Ω : ±400PPM/°C ≥20Ω : ±300PPM/°C	R2-R1 R1 (t2-t1) x 10 ⁶ (PPM/°C)
Short Time Overload:	± (2% + 0.05Ω) Max	RCWV*2.5 for 5 seconds
Load Life:	±(5.0%+0.05Ω)	70±2°C Max. working voltage for 1000 hrs with 1.5 hrs "ON" and 0.5 hrs "OFF"
Load Life in Humidity:	±(5.0%+0.05Ω)	40±2°C, 90-95% R.H. Max working voltage for 1000 hrs with 1.5hrs hrs "ON" and 0.5 hrs "OFF"
Solderability:	95% min. coverage	245±5°C for 3 seconds
Resistance to Soldering Heat:	±(1.0%+0.05Ω)	Leads immersed 3.2 – 4.8 mm from body - 350±10°C for 3±0.05 seconds
Resistance to Solvent:	No deterioration of protective coating and markings	Immersed in trichroethane bath for 3 minutes with ultrasonic
Surge Immunity Test:	±(5% + 0.05Ω) Max.	Refer to IEC61000-4-5
		Max Surge Voltage
		1/2W 1WS 4KV
		1W 2WS 5KV
		2W 3WS 6KV
		3W 5WS 8KV
		5W 7WS 9KV
		7W 8WS 10KV
		8W 9WS 11KV
		9W 10WS 12KV



1.2 μsec rising time and 50 μsec discharge; every 1 minute for 10 cycle

Storage Temperature: 25±3°C; Humidity 60% RH ±10%

Marking

For EP Normal Size 1/2W, 1W, 2W, 3W and EP Small Size 1WS, 2WS, 3WS, 5WS Resistors shall be marked with color coding in accordance with JIS C 0802.

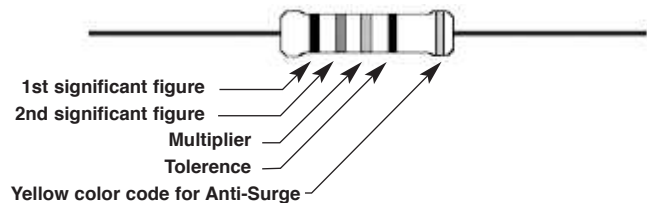

For EP Normal Size 5W, 7W, 8W 9W and EP Small Size 7WS, 8WS, 9WS, 10WS Resistors will be marked with power rating, nominal resistance and resistance tolerance code.

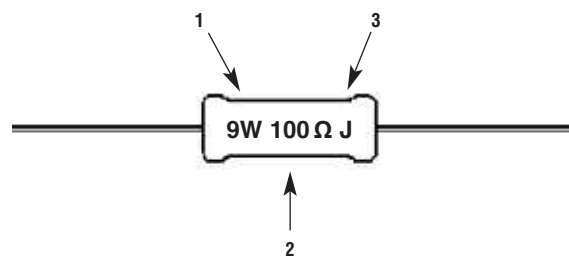

Type EP Series

Packaging

EP Normal Size: 1/2W, 1W, 2W, 3W and EP Small Size 1WS, 2WS, 3WS, 5WS supplied taped in "ammo boxes". All larger sizes supplied bulk packed in boxes

How to Order

EP Common Part	3W Power rating	200R Nominal Resistance	J Resistance Tolerance
EP	05W = 1/2W 1W = 1W 1WS = 1WS As per Electrical characteristics chart	10Ω – 10R 1KΩ -1K0 (1000Ω)	F = ±1% G = ±2% J = ±5% K = ±10%

TE Connectivity, TE connectivity (logo) and TE (logo) are trademarks.
Other logos, product and Company names mentioned herein may be trademarks of their respective owners.

While TE has made every reasonable effort to ensure the accuracy of the information in this datasheet, TE does not guarantee that it is error-free, nor does TE make any other representation, warranty or guarantee that the information is accurate, correct, reliable or current. TE reserves the right to make any adjustments to the information contained herein at any time without notice. TE expressly disclaims all implied warranties regarding the information contained herein, including, but not limited to, any implied warranties of merchantability or fitness for a particular purpose. The dimensions in this datasheet are for reference purposes only and are subject to change without notice. Specifications are subject to change without notice. Consult TE for the latest dimensions and design specifications.

X-ON Electronics

Largest Supplier of Electrical and Electronic Components

Click to view similar products for [Wirewound Resistors - Through Hole category](#):

Click to view products by [TE Connectivity manufacturer](#):

Other Similar products are found below :

[75822-2K4](#) [90J56R](#) [AC03000001208JAC00](#) [EP3WS47RJ](#) [C1010KJL](#) [C1015RJL](#) [C3A10KJT](#) [27J1K0](#) [ES3W47RJ](#) [AC04000001500JAC00](#)
[AC10000002208JAB00](#) [AC10000004708JAB00](#) [SQMW5R39J](#) [SQPW5R22J](#) [SQPW5R33J](#) [1879927-3](#) [FCB2100RJ](#) [T505](#) [FSQ5WR47J](#)
[FW10A33R0JA](#) [C1010RJL](#) [C10220RJL](#) [C10R47JL](#) [C141K0JL](#) [C144R7JL](#) [ES05W100RJ](#) [SQMW1047RJ](#) [SQMW210RJ](#) [ULW5-39R0JT075](#)
[W31-R47JA1](#) [ULW5-68RJT075](#) [SQBW401K0JFASTON](#) [SPH1001JLF](#) [65888-3R3](#) [SQP500JB-400R](#) [SQBW403R3JFASTON](#) [280-PRM7-](#)
[4.7-RC](#) [CW02B9R100JE73](#) [FW70A1000JA](#) [AC05000005608JAC00](#) [SQPW547RJ](#) [SQMW10R68J](#) [C102K2JL](#) [SQPW510RJ](#) [PW103001KLF](#)
[SQPW522RJ](#) [SQPW568RJ](#) [FCB4560RJ](#) [FCB2R47J](#) [SQPW2R047J](#)