

THIS DRAWING IS UNPUBLISHED. RELEASED FOR PUBLICATION 20
 © COPYRIGHT 20 BY Tyco Electronics Japan G.K. ALL RIGHTS RESERVED.

LOC	DIST	REVISIONS					
J	-	P	LTR	DESCRIPTION	DATE	DWN	APVD
			E	REVISED	14JUN2011	M.M	N.Y
			E1	REVISED PER ECR-17-007048	16MAY2017	N.W	C.W

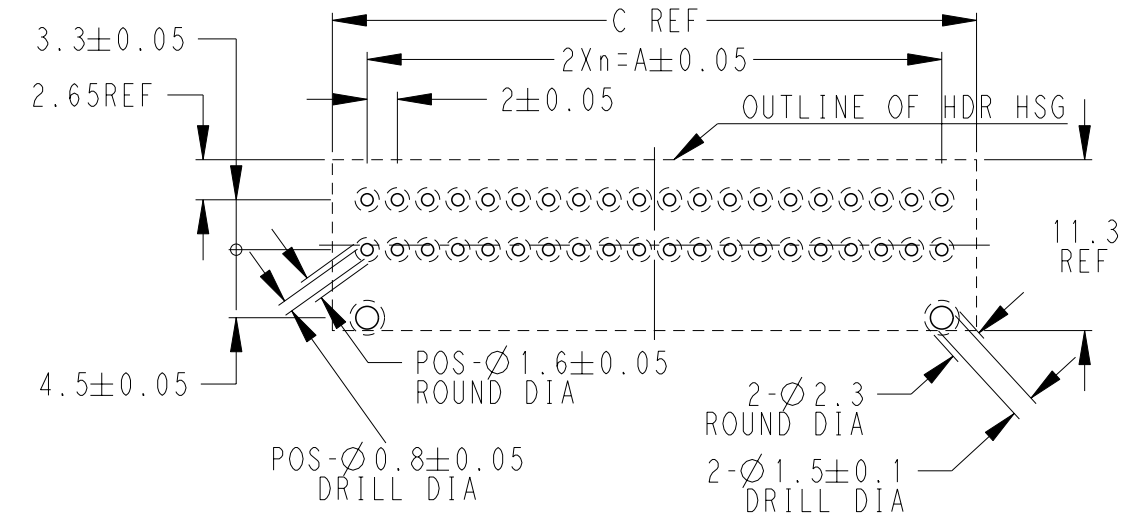
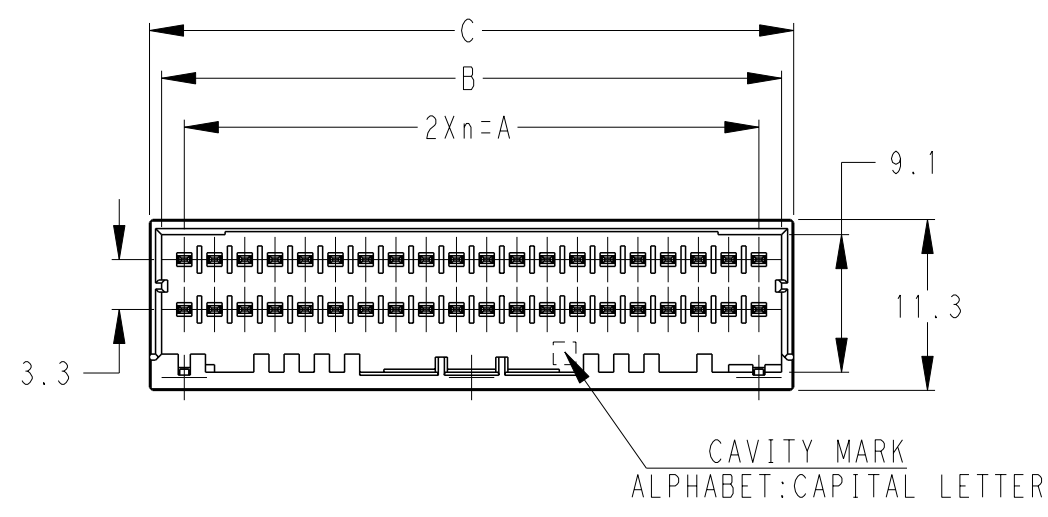

RECOMMEND PC BOARD HOLE PATTERN
 : CONNECTOR MOUNT SIDE (NOT ACCUMULATE TOLERANCE)
 PC BOARD THICKNESS : 1.0~1.6±0.1

- 1-1871056-□ : NATURAL (X-KEY) PRE-TIN
- 3-1871056-□ : YELLOW (X-KEY) PRE-TIN
- 5-1871056-□ : RED (X-KEY) PRE-TIN
- 6-1871056-□ : BLACK (X-KEY) TIN PLATED

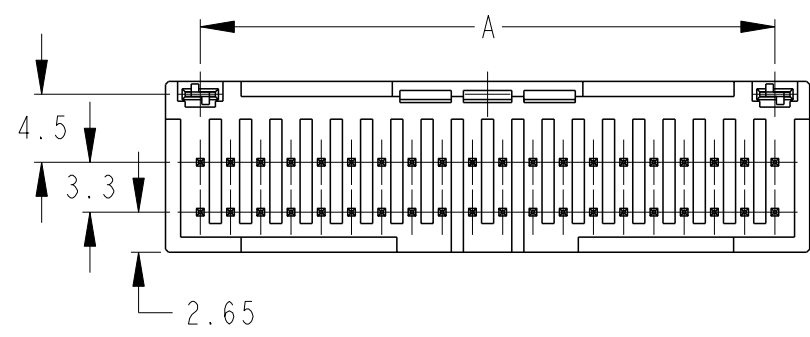
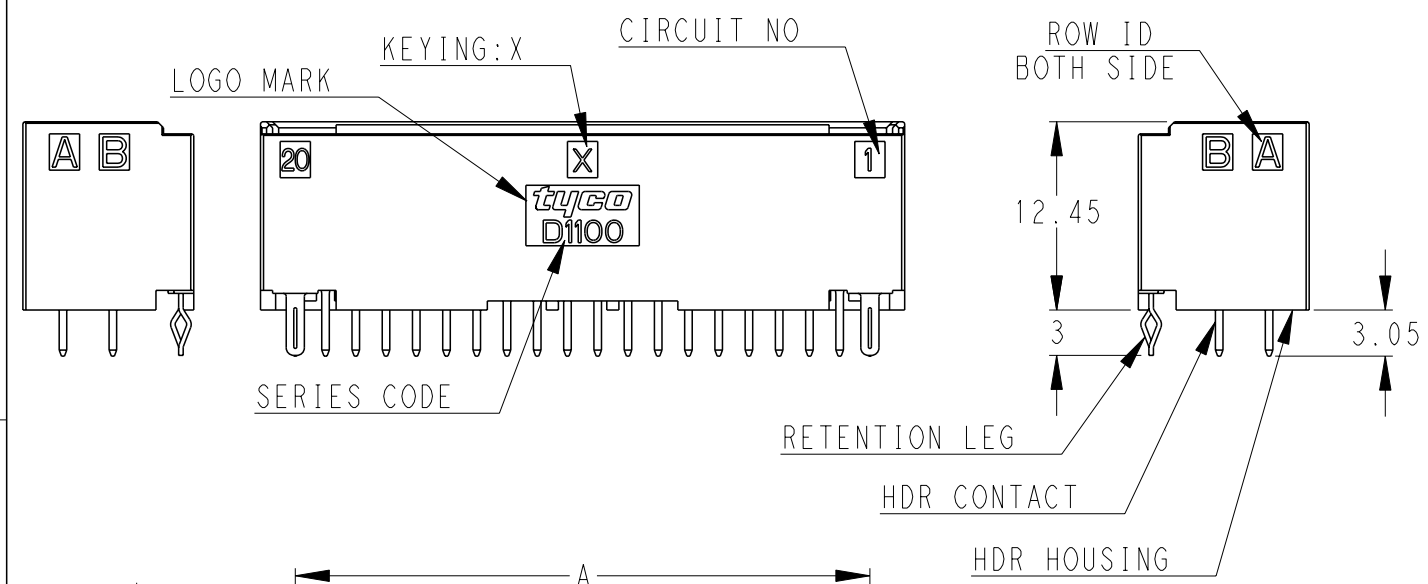

1 MATERIAL:
 HOUSING : GLASS FILLED THERMO PLASTIC
 POLYESTER(94V-0), COLOR: EXCLUDING BLACK
 CONTACT : PRE-TIN COPPER ALLOY, OR TIN PLATED ON COPPER ALLOY
 RETENTION LEG : PRE-TIN COPPER ALLOY

40	X	19	38.0	41.0	42.6	BLACK	6-1871056-0
40	X	19	38.0	41.0	42.6	RED	5-1871056-0
40	X	19	38.0	41.0	42.6	YELLOW	3-1871056-0
40	X	19	38.0	41.0	42.6	NATURAL	1-1871056-0
34	X	16	32.0	35.0	36.6	BLACK	6-1871056-7
32	X	15	30.0	33.0	34.6	BLACK	6-1871056-6
32	X	15	30.0	33.0	34.6	NATURAL	1-1871056-6
30	X	14	28.0	31.0	32.6	BLACK	6-1871056-5
30	X	14	28.0	31.0	32.6	YELLOW	3-1871056-5
30	X	14	28.0	31.0	32.6	NATURAL	1-1871056-5
28	X	13	26.0	29.0	30.6	BLACK	6-1871056-4
28	X	13	26.0	29.0	30.6	RED	5-1871056-4
26	X	12	24.0	27.0	28.6	BLACK	6-1871056-3
26	X	12	24.0	27.0	28.6	NATURAL	1-1871056-3
24	X	11	22.0	25.0	26.6	BLACK	6-1871056-2
24	X	11	22.0	25.0	26.6	YELLOW	3-1871056-2
22	X	10	20.0	23.0	24.6	BLACK	6-1871056-1
22	X	10	20.0	23.0	24.6	YELLOW	3-1871056-1
POS KEY	n	A	B	C	COLOR	PART NO	

- 40POS(X-KEY):
 1-1871056-0(NATURAL)
 3-1871056-0(YELLOW)
 5-1871056-0(RED)

THIS DRAWING IS A CONTROLLED DOCUMENT.		DWN T. KUDO 21APR2005	TE Connectivity NAME DYNAMIC 1100D 2.0mmPITCH HDR ASSY (V-TYPE) TIN PLATE-COLOR 22-40POS				
DIMENSIONS: mm		CHK D. MITSUGI 23AUG2005					
TOLERANCES UNLESS OTHERWISE SPECIFIED: ±0.3, ±5°		APVD D. MITSUGI 23AUG2005					
0-PLC ± 1-PLC ±0.1 2-PLC ±0.01 3-PLC ±0.001 4-PLC ±0.0001 ANGLES ±		PRODUCT SPEC 108-78298					
MATERIAL 1		FINISH -	APPLICATION SPEC 114-5377	SIZE A3	CAGE CODE 00779	DRAWING NO C-1871056	RESTRICTED TO -
CUSTOMER DRAWING			WEIGHT -	SCALE 2:1	SHEET 1 OF 3	REV E1	

THIS DRAWING IS UNPUBLISHED.

RELEASED FOR PUBLICATION

20

© COPYRIGHT 20

BY Tyco Electronics Japan G.K.

ALL RIGHTS RESERVED.

LOC	DIST	REVISIONS					
		P	LTR	DESCRIPTION	DATE	DWN	APVD
J	-			SEE SHEET 1 OF 3			

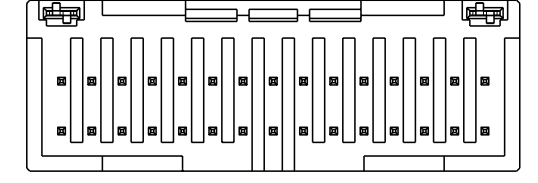
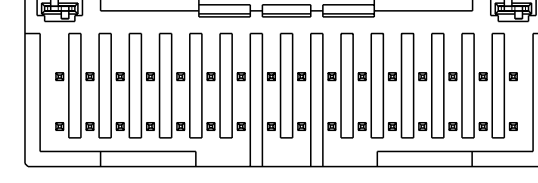
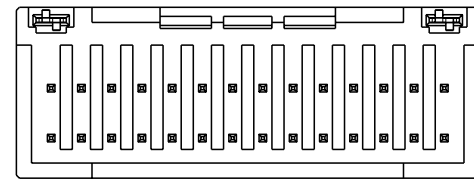
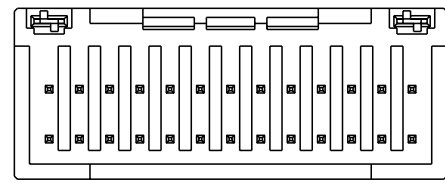
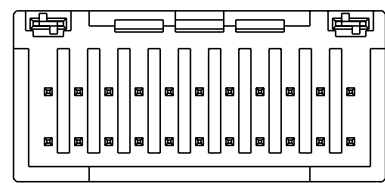
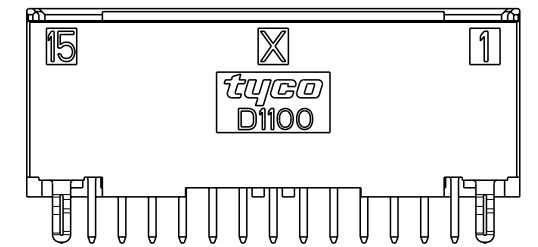
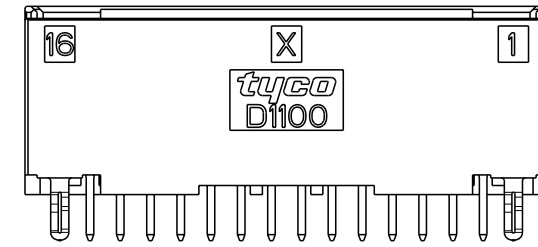
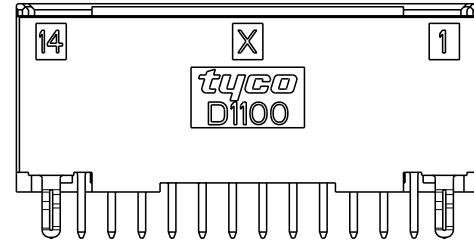
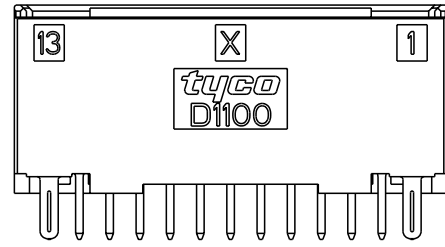
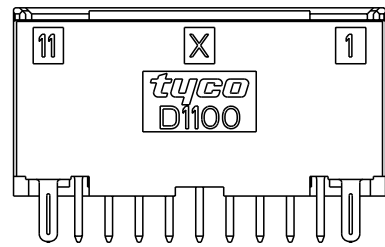
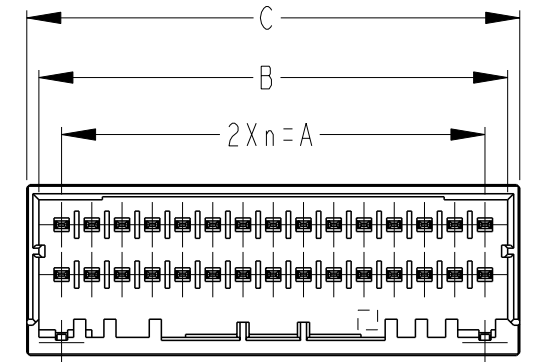
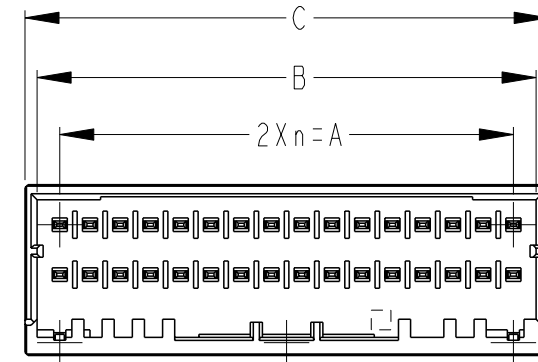
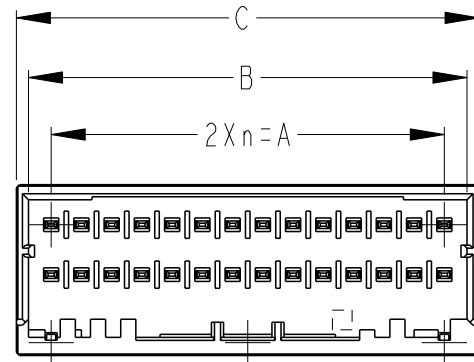
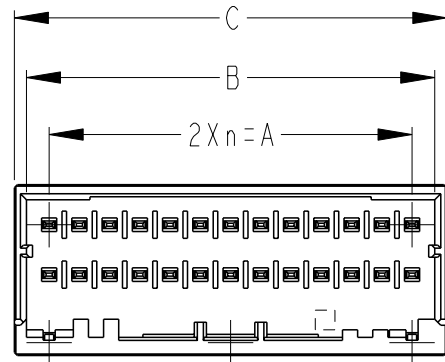
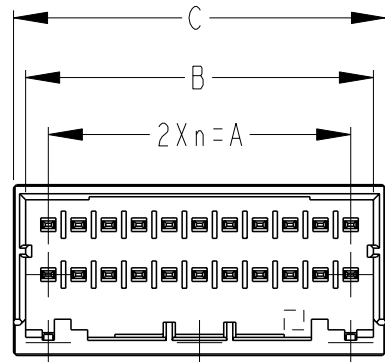

22POS(X-KEY):
3-1871056-1(YELLOW)

26POS(X-KEY):
1-1871056-3(NATURAL)

28POS(X-KEY):
5-1871056-4(RED)

32POS(X-KEY):
1-1871056-6(NATURAL)

30POS(X-KEY):
1-1871056-5(NATURAL)
3-1871056-5(YELLOW)

THIS DRAWING IS A CONTROLLED DOCUMENT.		DWN T. KUDO 21APR2005	TE Connectivity	
DIMENSIONS: mm		CHK D. MITSUGI 23AUG2005		
TOLERANCES UNLESS OTHERWISE SPECIFIED:		APVD D. MITSUGI 23AUG2005	NAME DYNAMIC 1100D 2.0mmPITCH HDR ASSY (V-TYPE) TIN PLATE-COLOR 22-40POS	
0 PLC ± 1 PLC ± 2 PLC ± 3 PLC ± 4 PLC ± ANGLES ±		PRODUCT SPEC 108-78298	SIZE A3	
MATERIAL		APPLICATION SPEC 114-5377	CAGE CODE 00779	DRAWING NO C-1871056
FINISH		WEIGHT	RESTRICTED TO	
		CUSTOMER DRAWING	SCALE 2:1	SHEET 2 OF 3
			REV E1	

SEE SHEET 1 OF 3

THIS DRAWING IS UNPUBLISHED.

RELEASED FOR PUBLICATION

20

© COPYRIGHT 20

BY Tyco Electronics Japan G.K.

ALL RIGHTS RESERVED.

LOC

DIST

REVISIONS

J

-

P

LTR

DESCRIPTION

DATE

DWN

APVD

SEE SHEET 1 OF 3

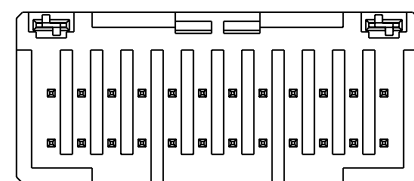
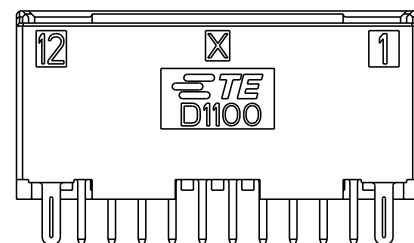
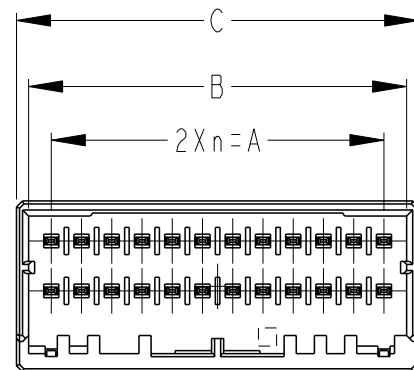

24POS(X-KEY):
3-1871056-2(YELLOW)

THIS DRAWING IS A CONTROLLED DOCUMENT.

DIMENSIONS:
mm



TOLERANCES UNLESS OTHERWISE SPECIFIED:

- 0 PLC ±
- 1 PLC ±
- 2 PLC ±
- 3 PLC ±
- 4 PLC ±
- ANGLES ±

MATERIAL

-

FINISH

-

DWN T. KUDO 21APR2005

CHK D. MITSUGI 23AUG2005

APVD D. MITSUGI 23AUG2005

PRODUCT SPEC

108-78298

APPLICATION SPEC

114-5377

WEIGHT

-

CUSTOMER DRAWING



TE Connectivity

NAME
DYNAMIC 1100D 2.0mmPITCH
HDR ASSY (V-TYPE)
TIN PLATE-COLOR 22-40POS

SIZE CAGE CODE DRAWING NO RESTRICTED TO

A3 00779 C-1871056 -

SCALE 2:1 SHEET 3 OF 3 REV E1

SEE SHEET 1 OF 3

X-ON Electronics

Largest Supplier of Electrical and Electronic Components

Click to view similar products for [Headers & Wire Housings](#) category:

Click to view products by [TE Connectivity](#) manufacturer:

Other Similar products are found below :

[95000-104TRLF](#) [10135584-644402LF](#) [DF62W-EP2022PCA](#) [95000-106TRLF](#) [DF62W-2022SCA](#) [DF62W-EP2022PC](#) [2203348](#) [DF62W-2022SC](#) [1084018](#) [1029039](#) [1084017](#) [802-10-012-10-002000](#) [1112640](#) [1112639](#) [000-34000](#) [0009482033](#) [0009507031](#) [57102-S06-03LF](#) [57202-S52-04LF](#) [PCN6-15S-2.5E](#) [0039019024](#) [58102-G61-06LF](#) [582553-1](#) [0009485154](#) [0009508121](#) [0022285053](#) [0050291907](#) [018731A](#) [LY20-4P-DT1-P1E-BR](#) [02.125.8002.8](#) [60101931](#) [60598-1 \(Cut Strip\)](#) [M1625-3R/100](#) [61062-3](#) [61082-181009](#) [636-1427](#) [638009-1](#) [641938-9](#) [641991-4](#) [644168-1](#) [647662-1](#) [65039-019ELF](#) [65817-002LF](#) [65817-015LF](#) [65863-015LF](#) [66207-023LF](#) [67016-026LF](#) [67046-001LF](#) [67095-007LF](#) [67230-005LF](#)