

THIS DRAWING IS UNPUBLISHED. RELEASED FOR PUBLICATION
 © COPYRIGHT - By - ALL RIGHTS RESERVED.

LOC		DIST		REVISIONS			
P	LTR	DESCRIPTION	DATE	DWN	APVD		
	S1	UPDATE PER ECO-12-021131	3 DEC 12	CAS	MKS		

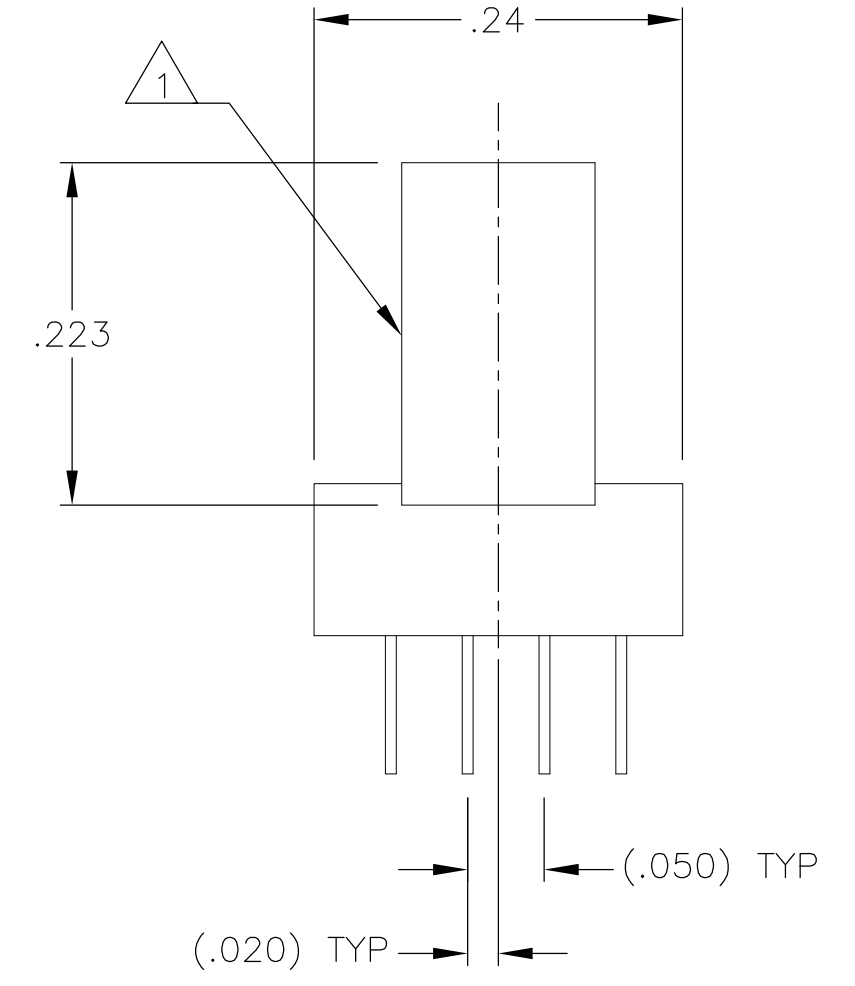
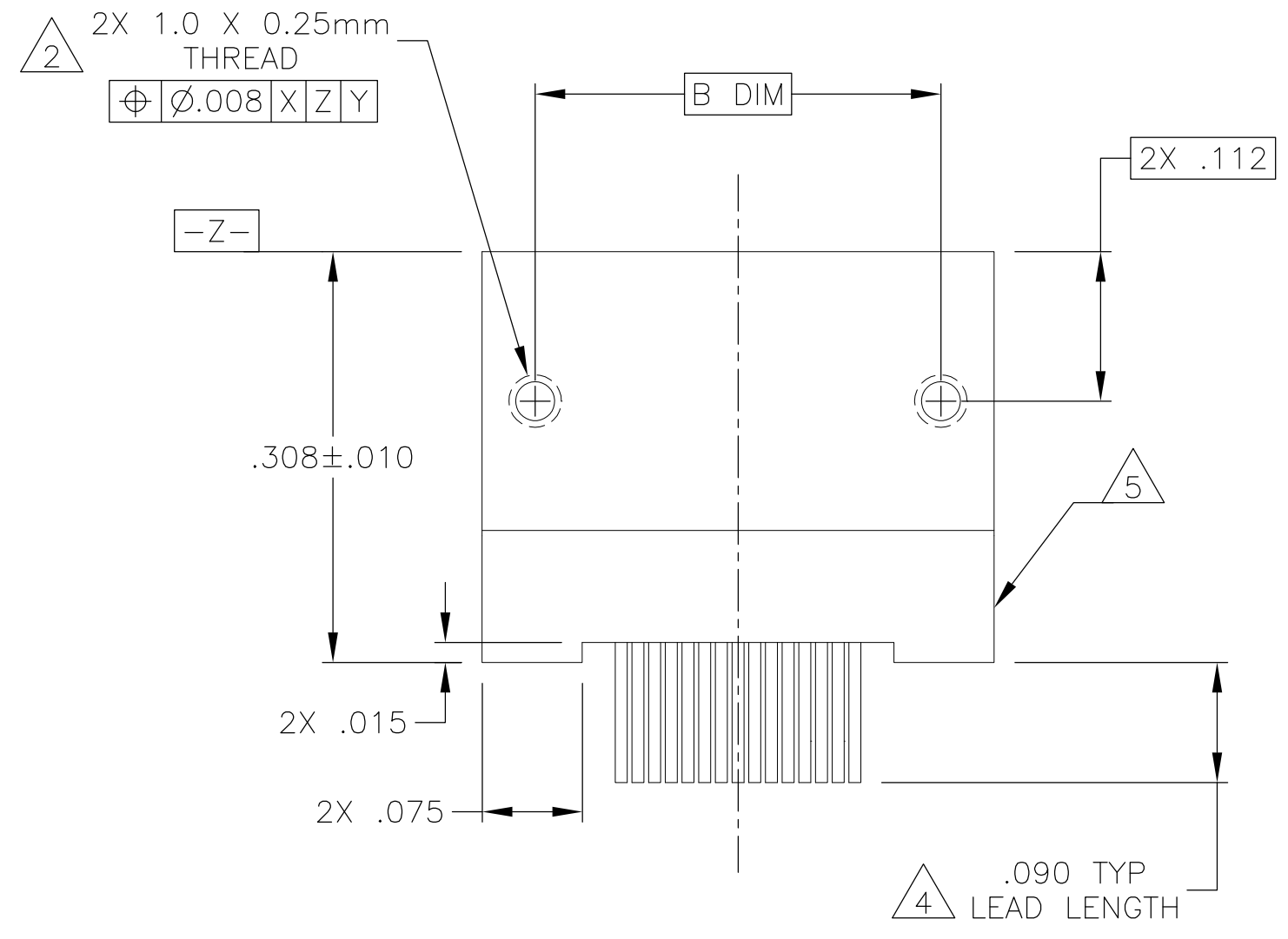
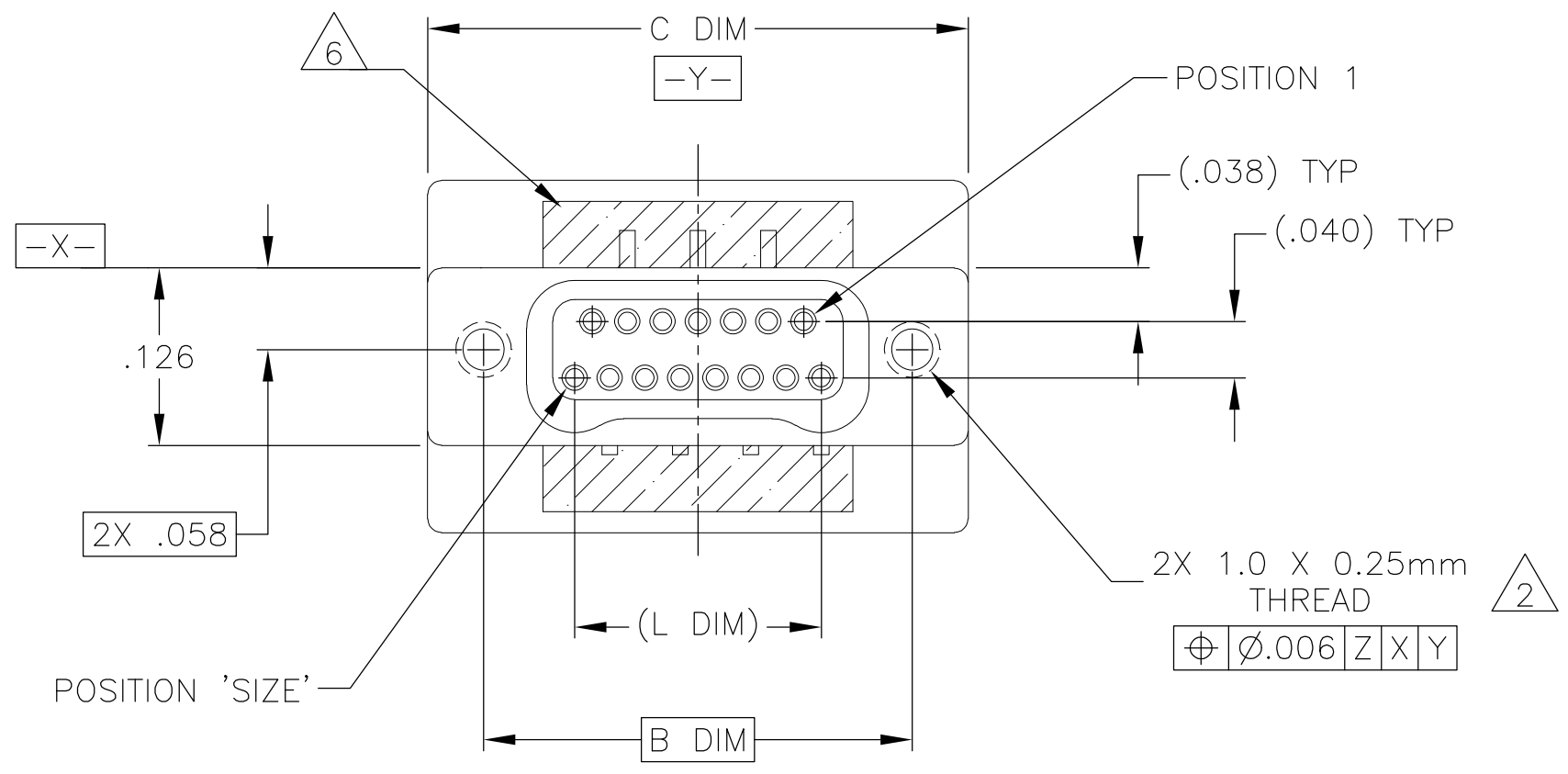

SIZE	B DIM	C DIM ±.0050	(L DIM)
09	.229	.3085	(.100)
15	.304	.3835	(.175)
25	.429	.5085	(.300)
37	.579	.6585	(.450)
51	.754	.8335	(.625)
65	.929	1.0085	(.800)

- 1. SHELL OPTIONS (TO BE SPECIFIED IN NANONICS PART NUMBER):
 METAL: 6061-T6 ALUMINUM, ELECTROLESS NICKEL PLATED PER SAE-AMS-C-26074 OR SAE-AMS-2404 (STANDARD) OR GOLD PLATED PER ASTM B488
 303 STAINLESS STEEL, PASSIVATED PER SAE-AMS-2700
 INSULATOR MATERIAL FOR ALL METAL SHELLS IS LIQUID CRYSTAL POLYMER (LCP) PER MIL-M-24519 OR PER ASTM D5138
 PLASTIC: LIQUID CRYSTAL POLYMER (LCP) PER MIL-M-24519 OR PER ASTM D5138
- 2. STANDARD 1.0 X 0.25mm MOUNTING AND JACKSCREW THREADS ARE SHOWN FOR REFERENCE ONLY AND MUST BE SPECIFIED IN THE NANONICS PART NUMBER WHEN REQUIRED. 1.2 X 0.25mm THREADS ALSO AVAILABLE.
- 3. MOUNTING HARDWARE IS AVAILABLE WITH THIS CONFIGURATION (NOT SHOWN). HARDWARE MUST BE SPECIFIED IN THE NANONICS PART NUMBER. CONSULT TYCO ELECTRONICS FOR DETAILS.
- 4. LEAD MATERIAL: HH BRASS, TIN LEAD PLATED 60/40 COMPOSITION PER SAE-AMS-P-81728
- 5. LEAD ORGANIZER MATERIAL IS LIQUID CRYSTAL POLYMER PER ASTM D5138
- 6. THROUGH HOLE LEADS ARE EPOXY ENCAPSULATED WITHIN THE LEAD ORGANIZER
- 7. NANONICS TERMINATION CODE: M5
- 8. THIS DRAWING PREVIOUSLY IDENTIFIED AS NANONICS N10138/252

THIS DRAWING IS A CONTROLLED DOCUMENT.		DWN D. RYAN 27 JUN 00		
DIMENSIONS: INCHES		CHK M. STORRY 15 AUG 00		
TOLERANCES UNLESS OTHERWISE SPECIFIED:		APVD -	NAME	
0 PLC ± -		PRODUCT SPEC	RECEPTACLE ASSEMBLY, VERTICAL MOUNT, THROUGH HOLE, 2 TO 4 ROW, .050 SPACING, PLASTIC OR METAL	
1 PLC ± -		APPLICATION SPEC	SIZE	CAGE CODE
2 PLC ± .010			A2	OJPN9
3 PLC ± .005			DRAWING NO	
4 PLC ± -			C=1589488	
ANGLES ± 1		WEIGHT	RESTRICTED TO	
FINISH			-	
MATERIAL SEE NOTES		CUSTOMER DRAWING	SCALE	SHEET
			8:1	1 of 2
			REV	S1

THIS DRAWING IS UNPUBLISHED. RELEASED FOR PUBLICATION
 © COPYRIGHT - By - ALL RIGHTS RESERVED.

LOC	DIST	REVISIONS			
P	LTR	DESCRIPTION	DATE	DWN	APVD
-	-	SEE SHEET 1	-	-	-

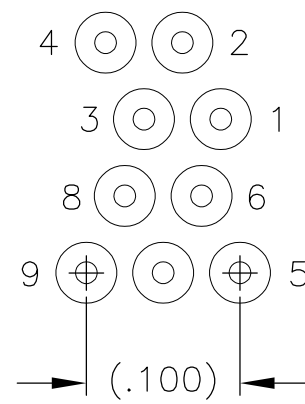

9 POSITION

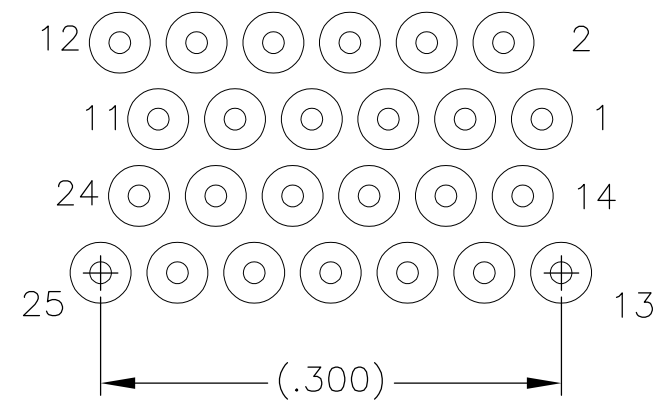

25 POSITION

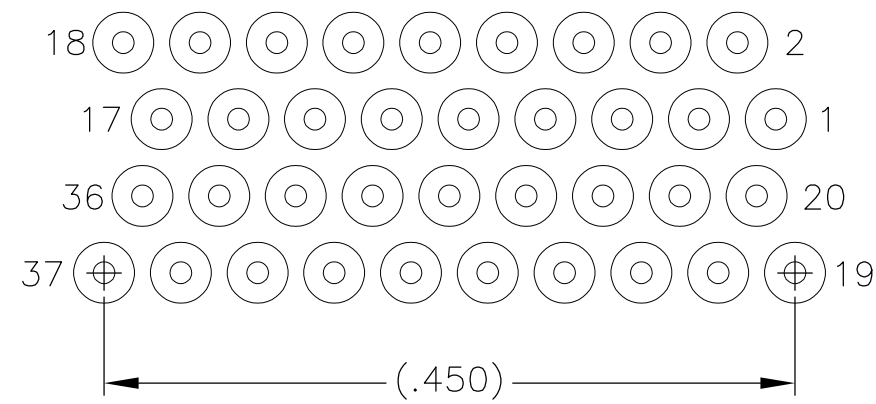

37 POSITION

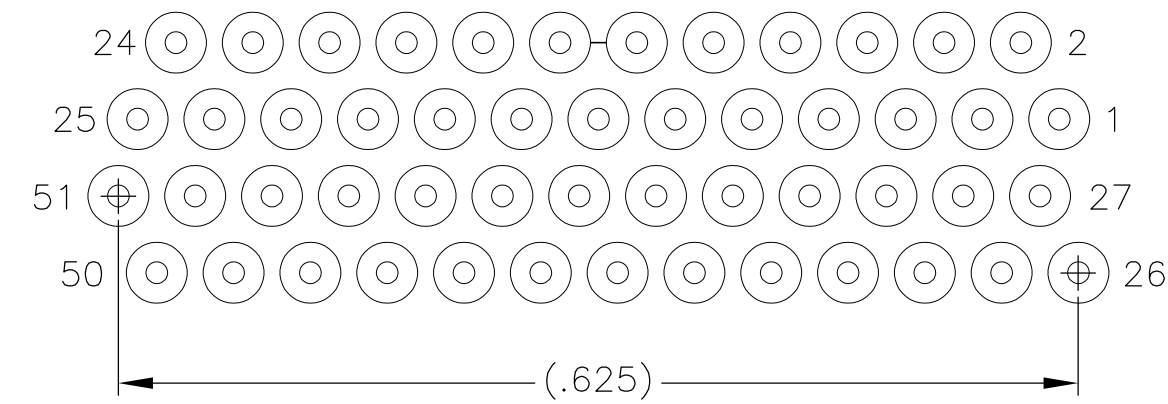

51 POSITION

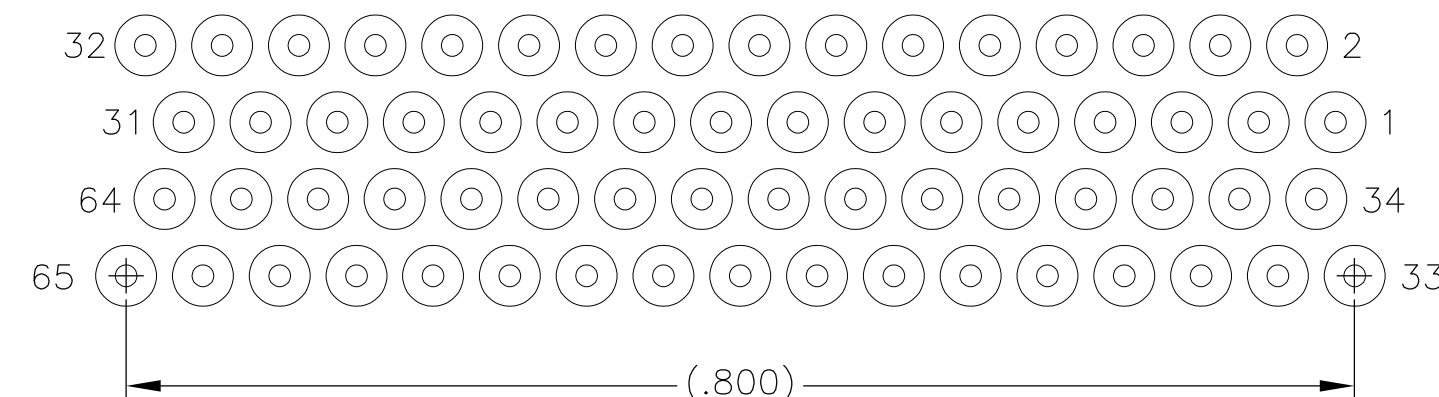

65 POSITION

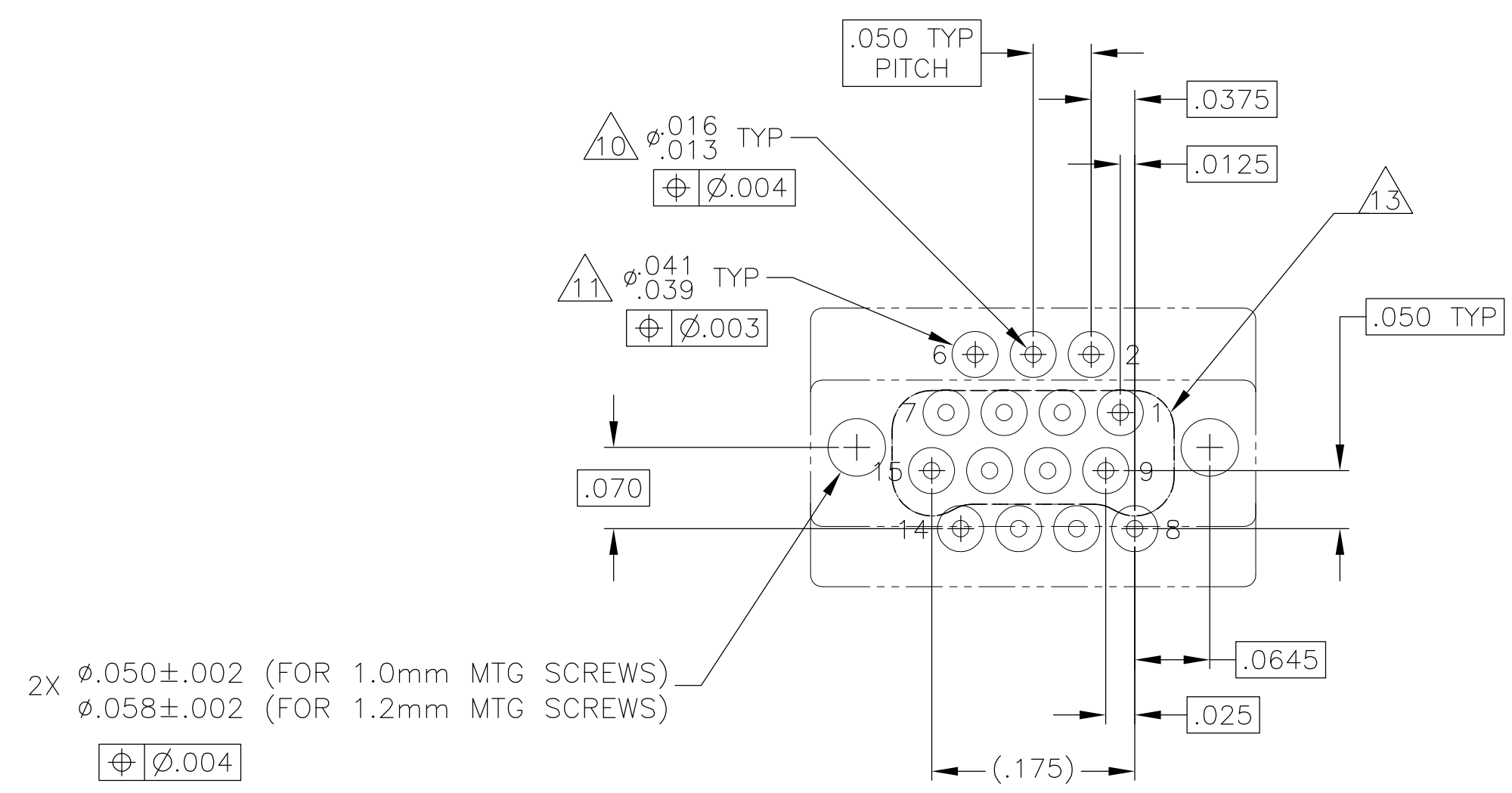

TYPICAL PCB LAYOUT
SIZE 15 SHOWN FOR REFERENCE

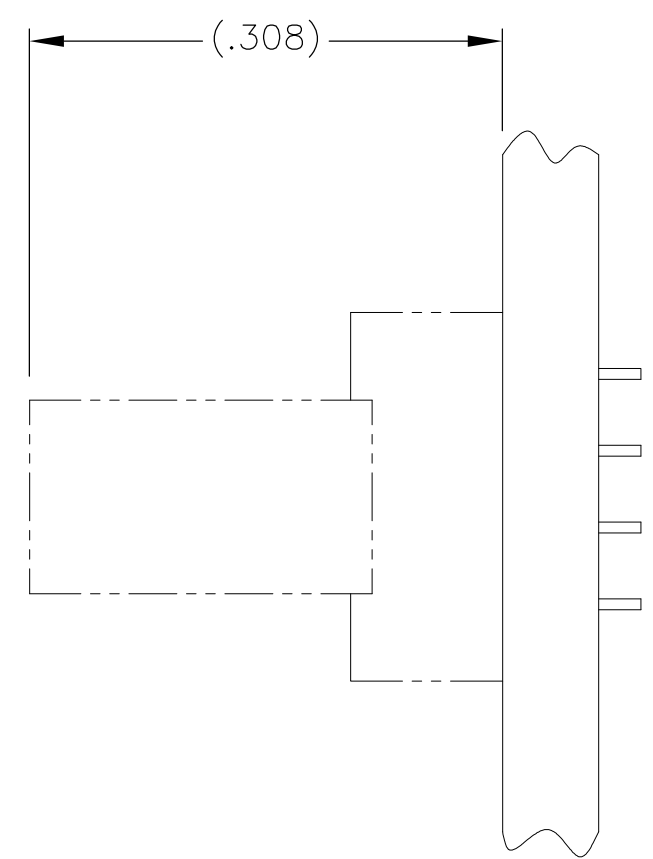

- 9. POSITIONAL TOLERANCES FOR BASIC DIMENSIONED FEATURES ARE RELATIVE TO FIDUCIALS OR SOME SIMILAR DATUM REFERENCES DEFINED BY PCB DESIGNER.
- 10. PLATED THROUGH HOLES
- 11. SOLDER PADS
- 12. ALL THROUGH HOLE LAYOUTS ARE AS VIEWED FROM TOP OF PCB.
- 13. CONNECTOR ORIENTATION

THIS DRAWING IS A CONTROLLED DOCUMENT.		DWN 27 JUN 00 D. RYAN	TE Connectivity	
DIMENSIONS: INCHES		CHK 15 AUG 00 M. STORRY	RECEPTACLE ASSEMBLY, VERTICAL MOUNT, THROUGH HOLE, 2 TO 4 ROW, .050 SPACING, PLASTIC OR METAL	
TOLERANCES UNLESS OTHERWISE SPECIFIED:		APVD -	SIZE A2	CAGE CODE OJPN9
0 PLC ± -		PRODUCT SPEC -	DRAWING NO C=1589488	RESTRICTED TO -
1 PLC ± -		APPLICATION SPEC -	SCALE 8:1	SHEET 2 OF 2
2 PLC ± .010		WEIGHT -	REV S1	
3 PLC ± .005		CUSTOMER DRAWING		
4 PLC ± -				
ANGLES ± 1				
FINISH SEE NOTES				
MATERIAL SEE NOTES				

X-ON Electronics

Largest Supplier of Electrical and Electronic Components

Click to view similar products for [Rectangular MIL Spec Connectors](#) category:

Click to view products by [TE Connectivity](#) manufacturer:

Other Similar products are found below :

[006-1169-16](#) [CSR31343-0001-00000](#) [CSR31346-0001-A0001](#) [CSR31899-0001-00000](#) [CSR31900-0001-A0001](#) [CTJ-3D-05](#) [CTS-S16/16](#)
[M55302/57A36X](#) [M55302/58-A70Y](#) [65002-062](#) [65008-D08](#) [CY4602-000](#) [732-8020-01](#) [732-8021-02 B](#) [77058-22-55PN](#) [81542-20](#)
[86.030.0053.0](#) [1241346-1](#) [RM252-020-311-2900](#) [DMC-M 08-16 SNE](#) [1589051-4](#) [BACC65CAMA](#) [BACC65CAMN](#) [BACC65CP1PN](#)
[BACI10BC1220PN](#) [18023-9](#) [HSB-D4S03DM222X](#) [2217548-1](#) [891-009-15SA2-BRT1T](#) [SIM2S100A](#) [1604996-2](#) [SMD25PN90L-4055](#)
[1925036-4](#) [220A012-25225-0](#) [22628-10-6P-791](#) [CSR31343-0001-A0001](#) [CSR31899-0001-A0001](#) [CSR31900-0001-00000](#) [33526M11-08PD](#)
[RE04-212S](#) [CTD160E01F-6148](#) [CTJ112E03B](#) [CTJ122E02D-8000](#) [CTJ-3D-12](#) [CTJ920E06N-513](#) [CTJ920E12N-513](#) [CTL-16-090](#) [CTR06-](#)
[5100SY](#) [M55302/63A20H](#) [M55302/66-30H](#)