

LOC		DIST		REVISIONS			
P	LTN	DESCRIPTION	DATE	DWN	APVD		
B1		REVISED PER ECO-16-014766	12OCT2016	RS	GJ		

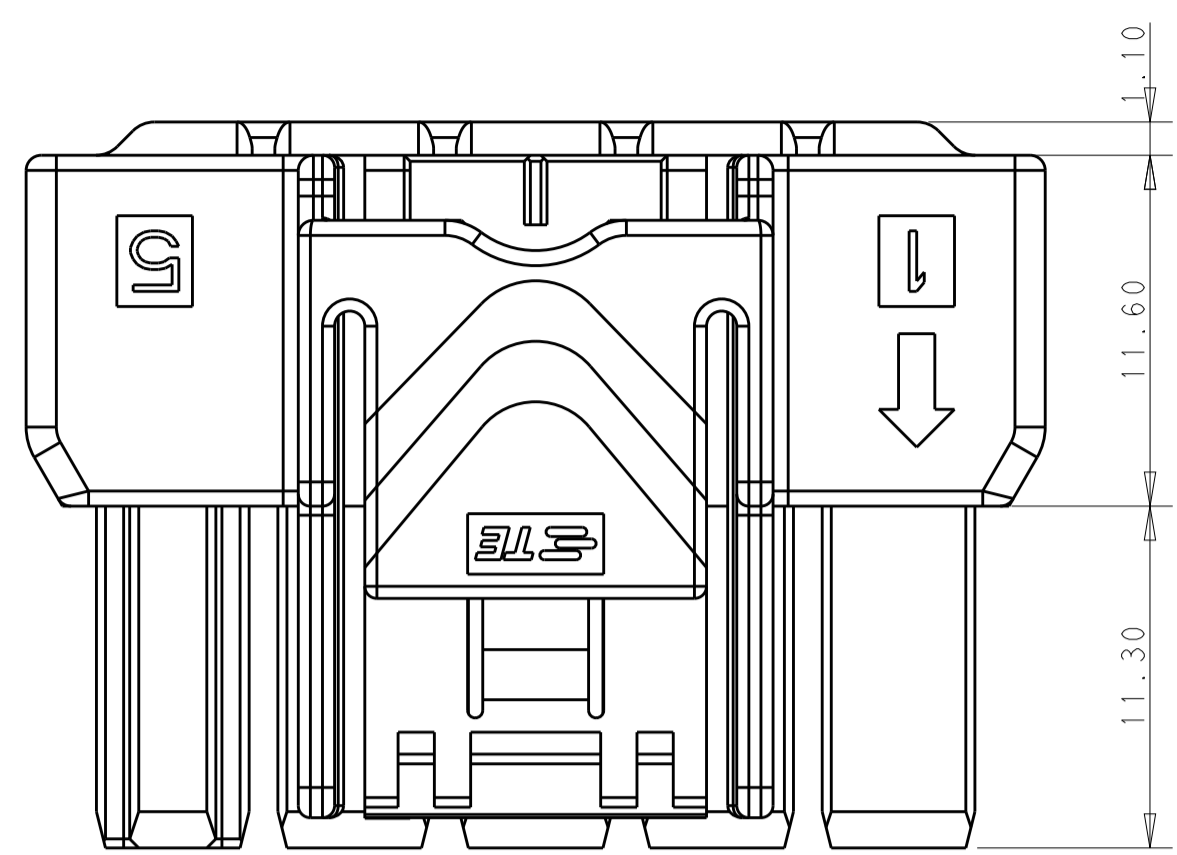

POS.	DIM. A
3*5	33.70
3*4	27.70
3*3	21.70

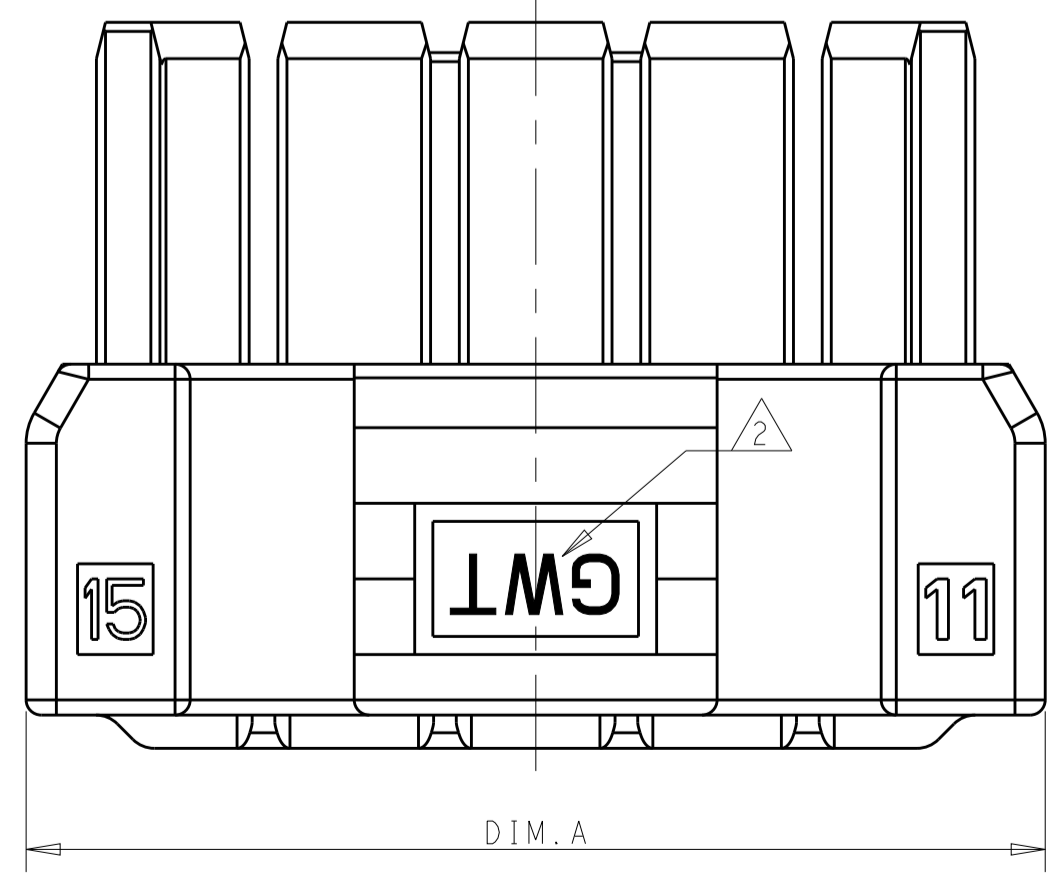
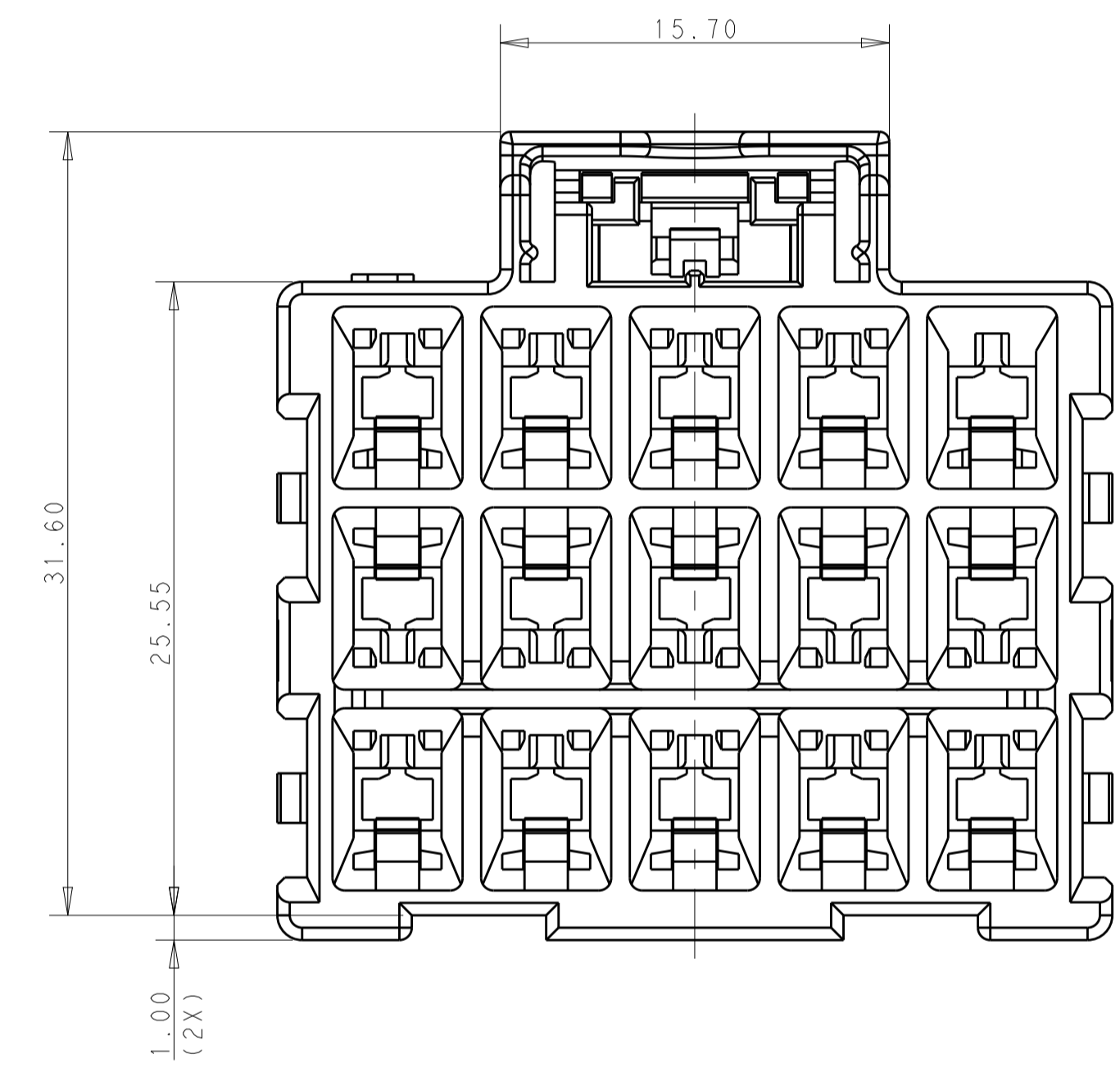
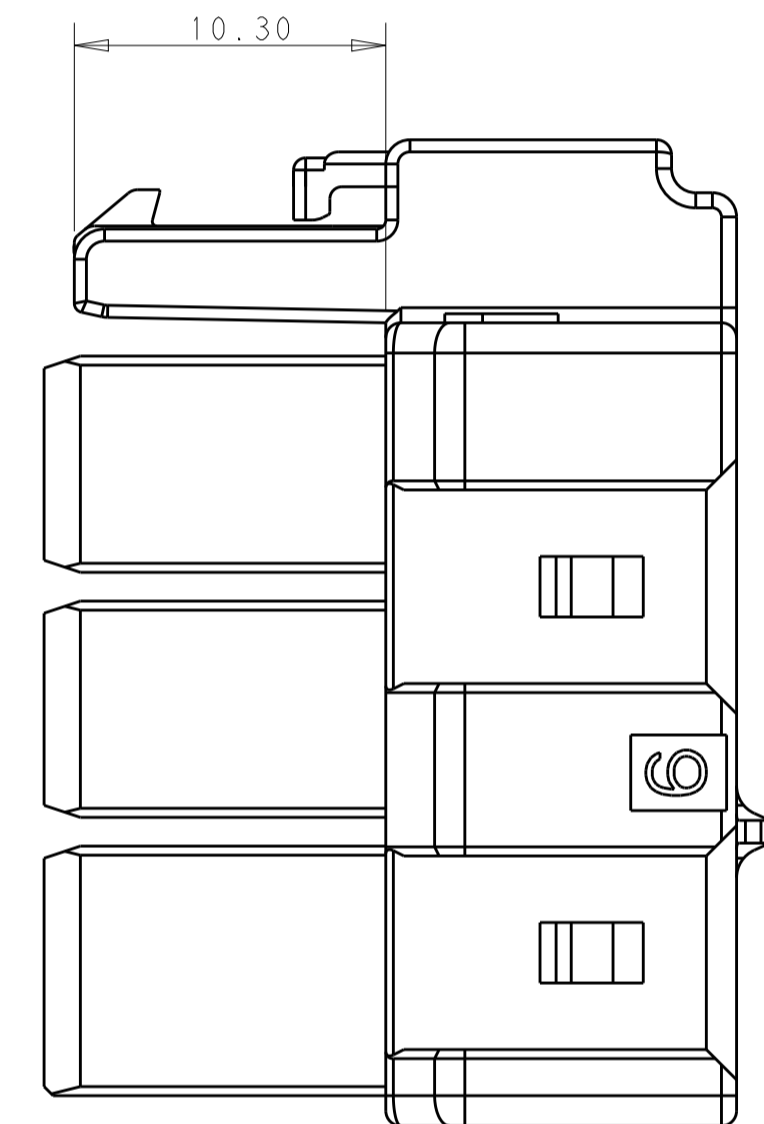
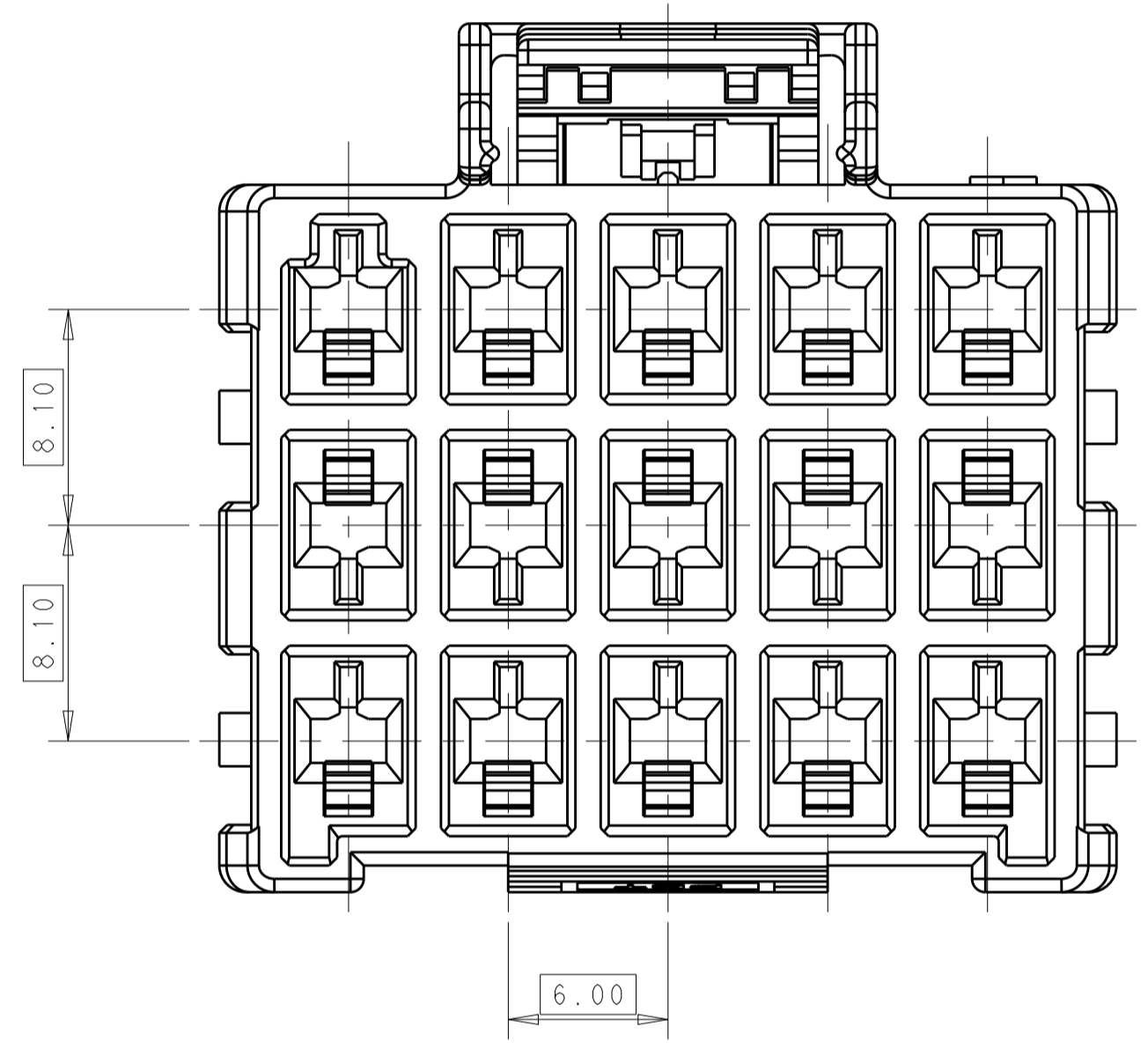

1 MATERIAL:
 LEVEL A: PA6, COMPLY WITH GLOW WIRE REQUIREMENTS FOR PARTS OF NON-METALLIC MATERIAL SUPPORTING A CURRENT-CARRYING CONNECTION DETAILED IN IEC 60335-1, SECTION 30 (GWT), UL 94V-0
 LEVEL B: PBT, HOT WIRE IGNITION (HWI) VERSION ARE MOLDED IN A RESIN THAT COMPLIES WITH TE HOT WIRE IGNITION TEST 109-32026 AND ARE RECOMMENDED FOR USE WITH HWI HOUSINGS THAT ALSO COMPLY, UL 94V-0

2 MATERIAL MARK:
 LEVEL A: GWT, LEVEL B: HWT

3. APPLICABLE CONTACT P/N
 RECEPTACLE CONTACT: 1971237/1971779/81/83/85/87-*; 2238066-*

4. MATING CONN. P/N
 CAP HSG: *-2232356/60-*
 DOUBLE ROW TPA: *-1971778-*; SINGLE ROW TPA: *-1971777-*

5. THIS PRODUCT HAS NOT COMPLETED VALIDATION TESTING.

THIS DRAWING IS A CONTROLLED DOCUMENT.		DWN: TOMMY_WU 26MAR2013	TE Connectivity NAME: PLUG HOUSING, TRIPLE ROW POWER TRIPLE LOCK
DIMENSIONS:		CHK: HAPYE_WU 26MAR2013	
TOLERANCES UNLESS OTHERWISE SPECIFIED:		APVD: YIHONG_MAO 26MAR2013	
mm	0 PLC ±	PRODUCT SPEC	SIZE: CAGE CODE DRAWING NO
	1 PLC ±0.35	108-106118	RESTRICTED TO
	2 PLC ±0.25	APPLICATION SPEC	A100779C=2232357
	3 PLC ±		SCALE 3:1 SHEET 1 OF 2 REV B1
	4 PLC ±		
	ANGLES ±		
MATERIAL	FINISH	WEIGHT	Customer Drawing

LOC		DIST		REVISIONS			
P	LTN	DESCRIPTION	DATE	OWN	APVD		
-SEE SHEET 1-							

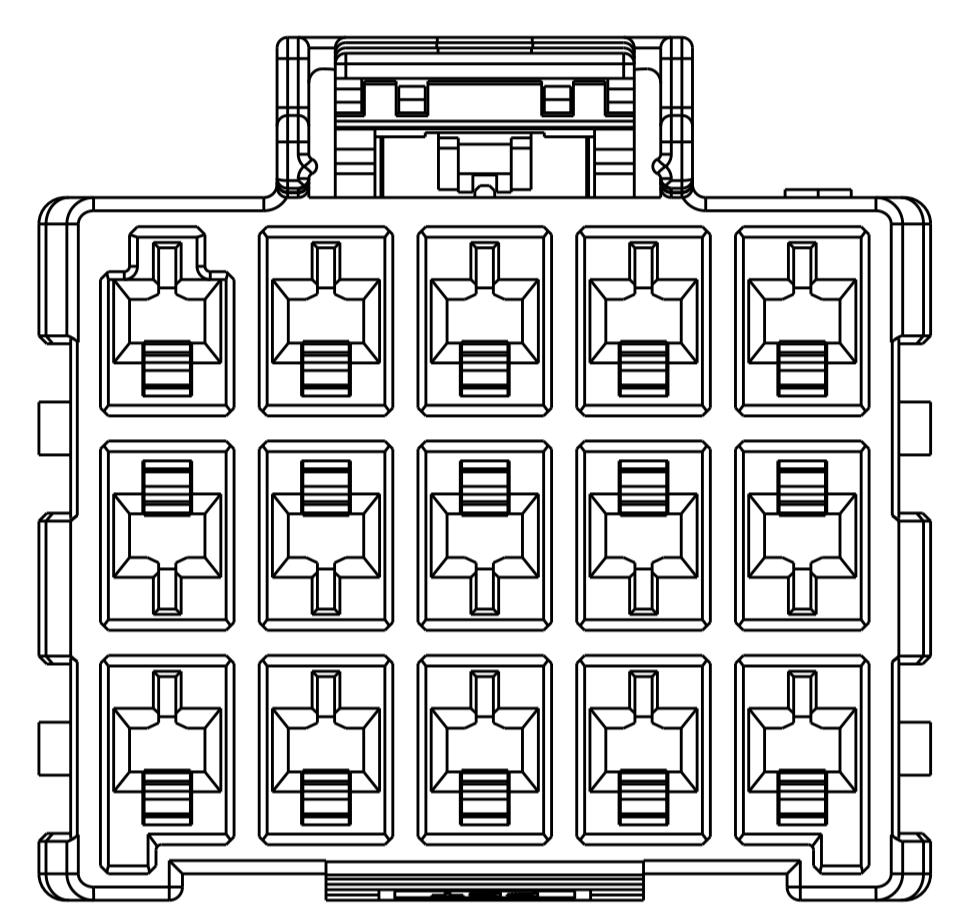
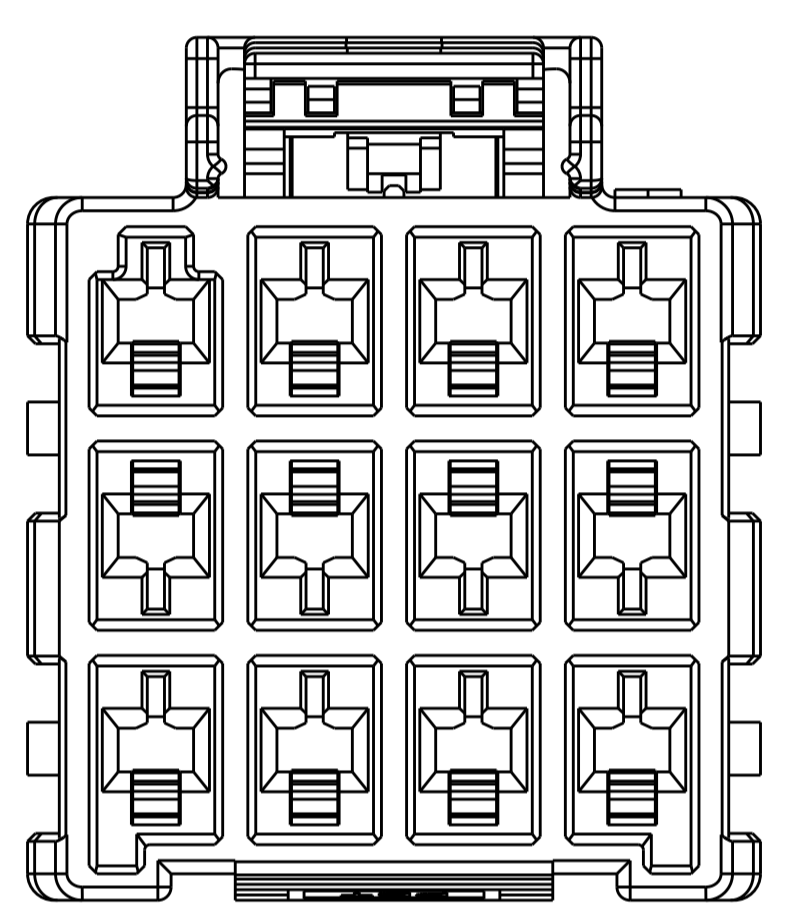
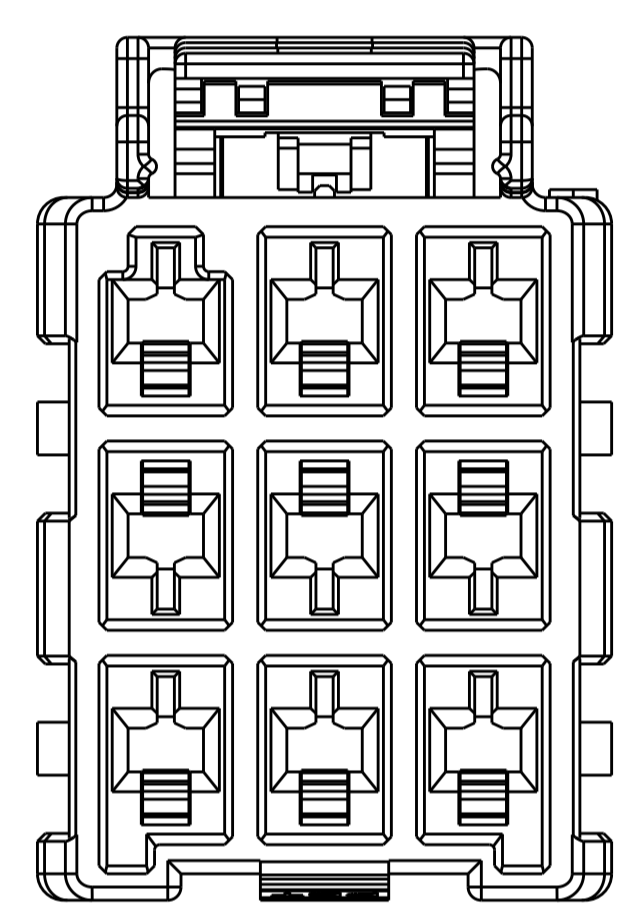
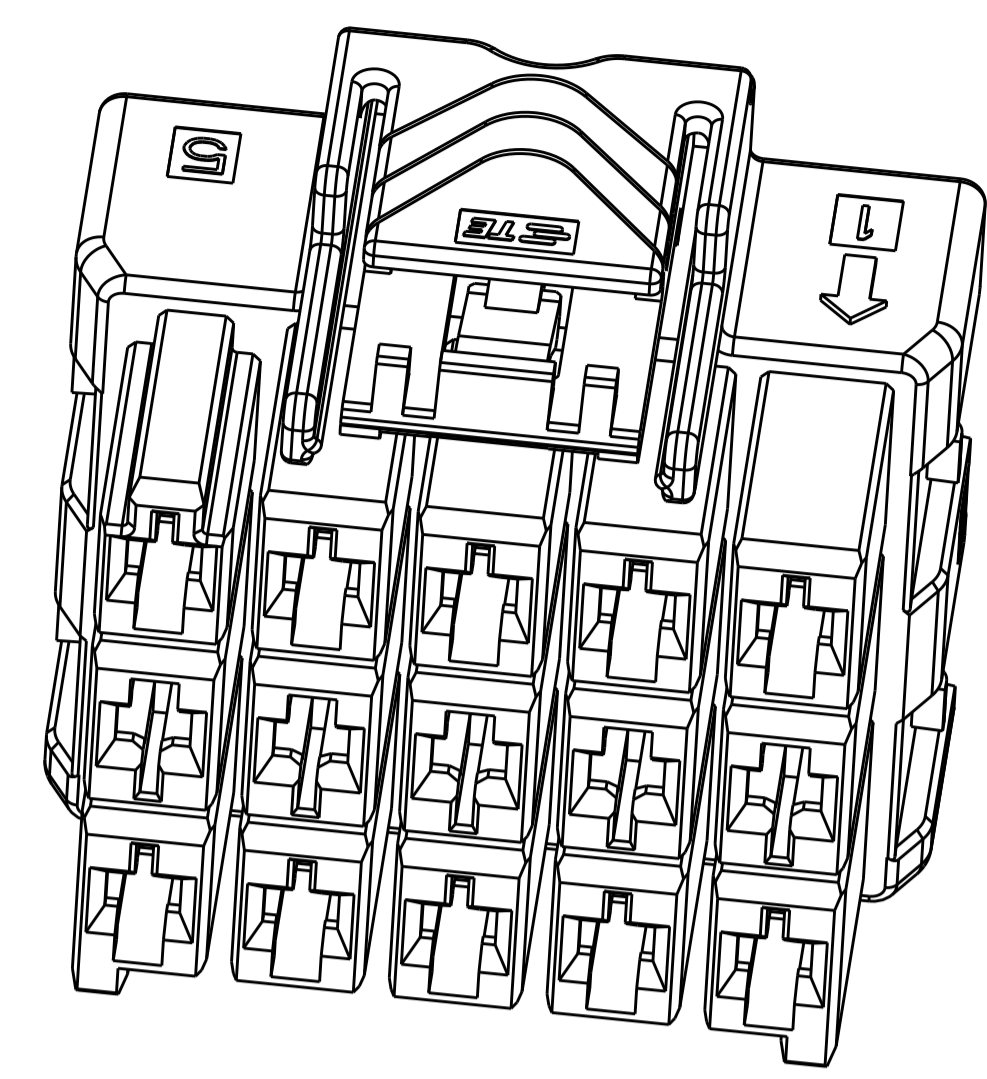
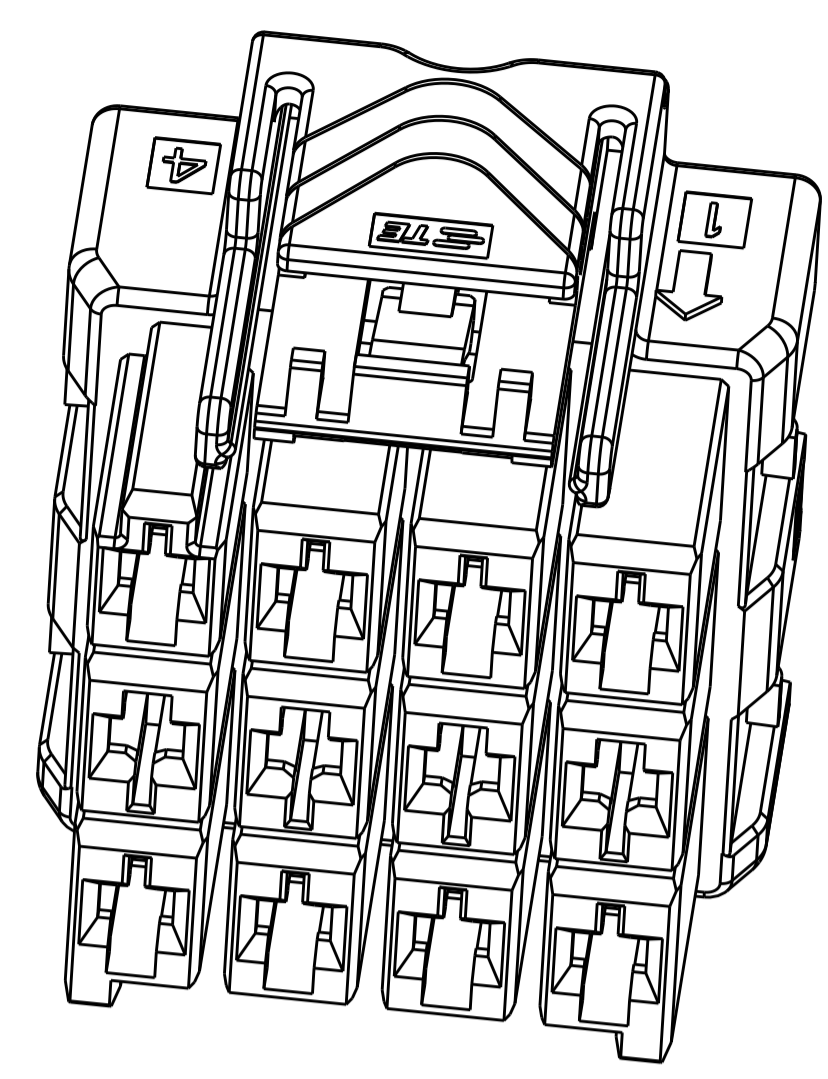
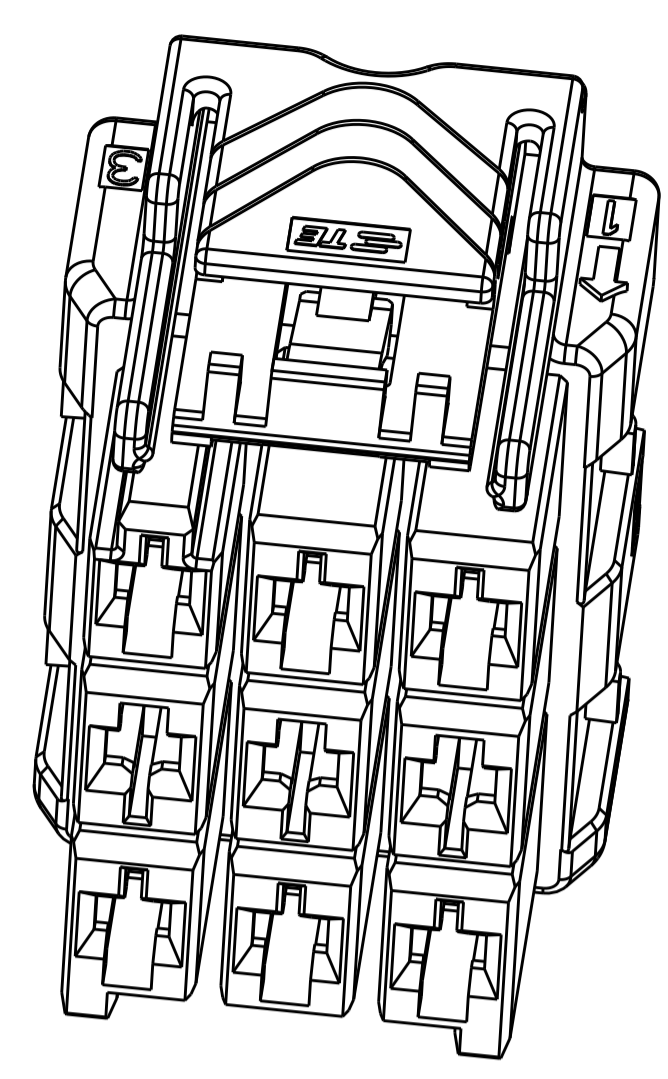

POS.	MATERIAL	COLOR	KEY	P/N
3*5	LEVEL A	DARK GREY	KEY A	5-2232357-7
		BROWN	KEY B	6-2232357-7
		GREEN	KEY C	7-2232357-7
		ORANGE	KEY D	8-2232357-7
3*4	LEVEL A	BLACK	KEY A	1-2232357-5
		DARK GREY	KEY A	5-2232357-4
		BROWN	KEY B	6-2232357-4
		GREEN	KEY C	7-2232357-4
3*3	LEVEL A	ORANGE	KEY D	8-2232357-4
		BLACK	KEY A	1-2232357-4
		DARK GREY	KEY A	5-2232357-3
		BROWN	KEY B	6-2232357-3
3*3	LEVEL A	GREEN	KEY C	7-2232357-3
		ORANGE	KEY D	8-2232357-3
		BLACK	KEY A	1-2232357-6

3*3 POSITIONS

3*4 POSITIONS

3*5 POSITIONS

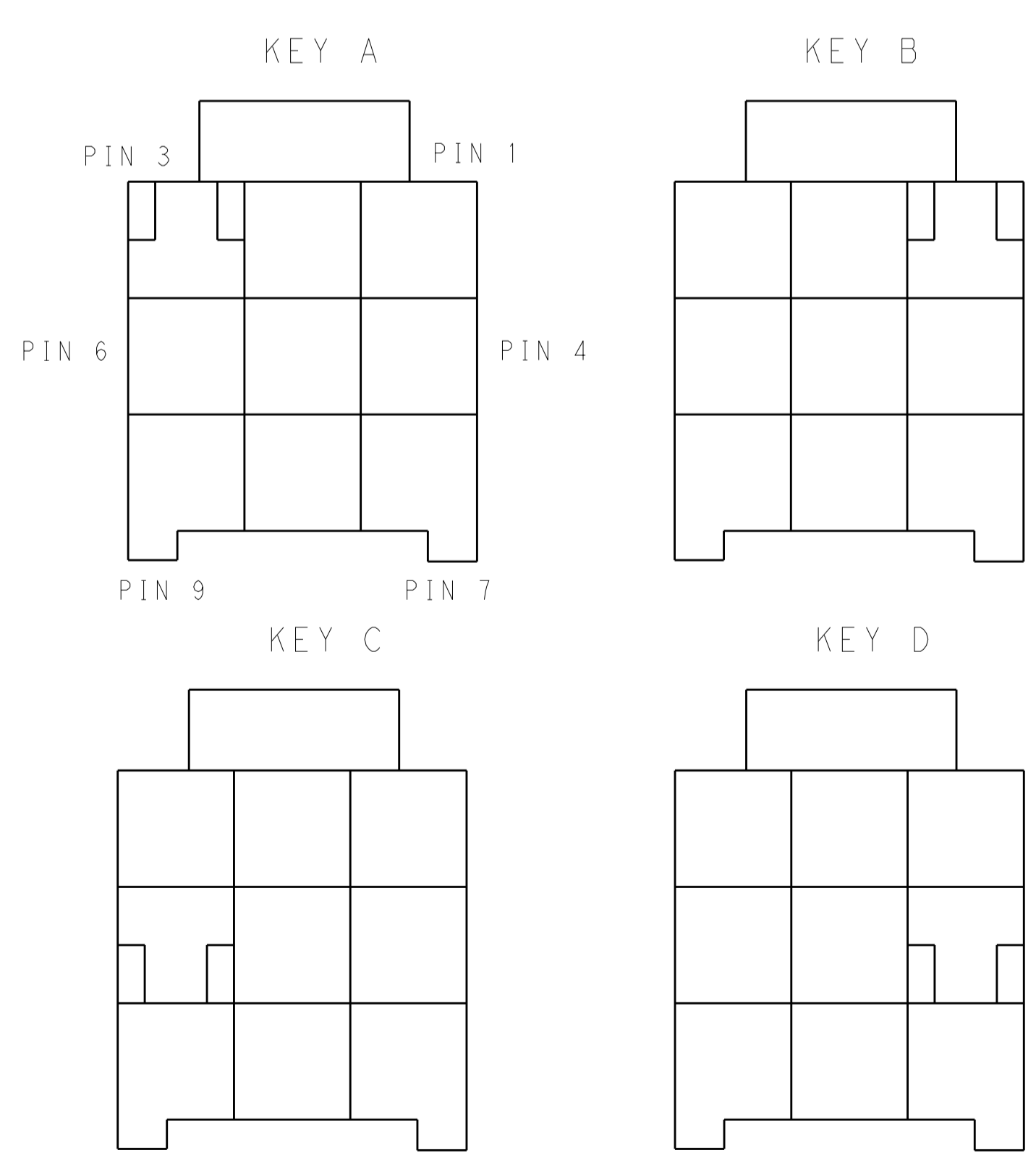

KEYING FOR 3*3 POS.

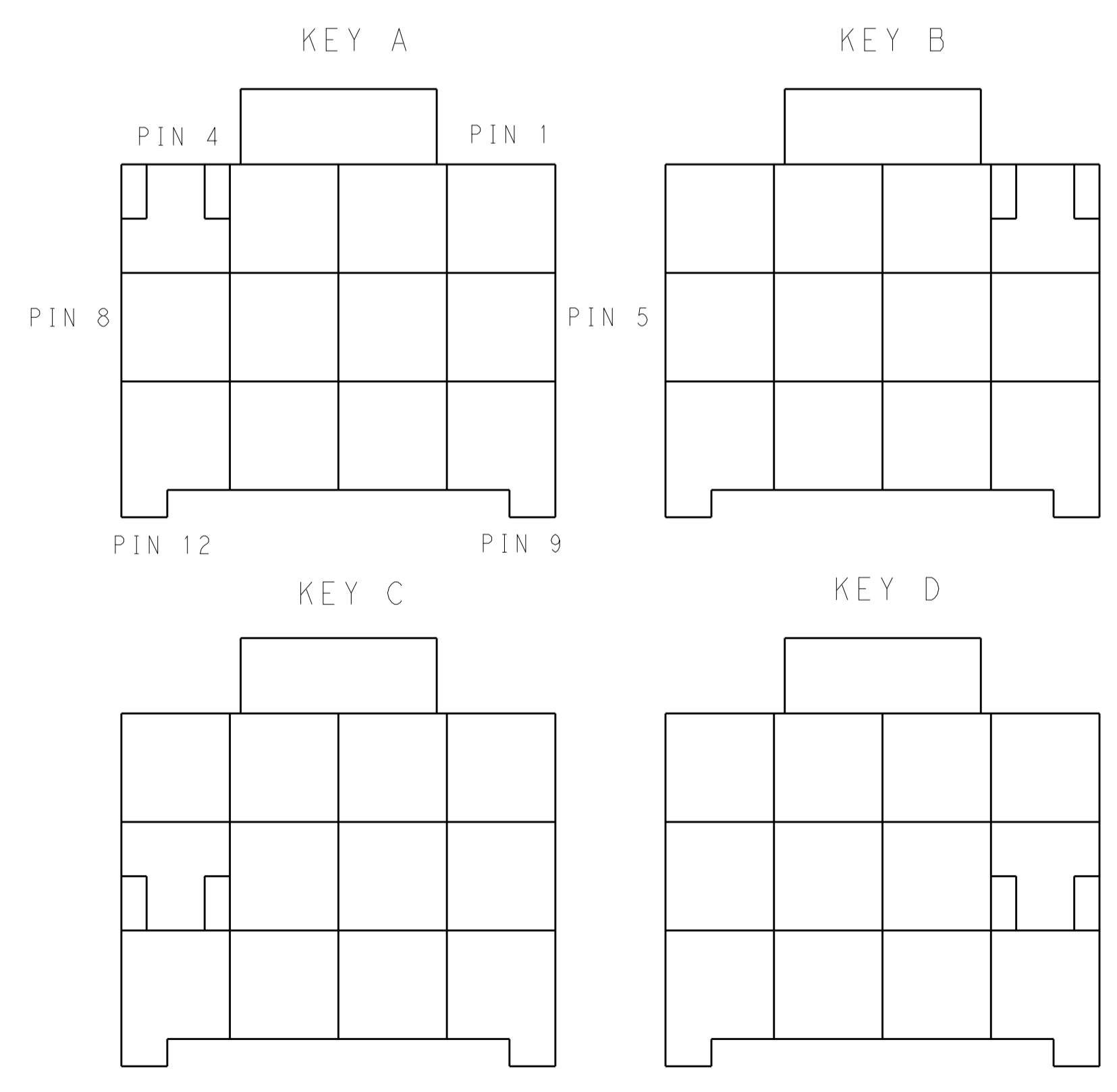

KEYING FOR 3*4 POS.

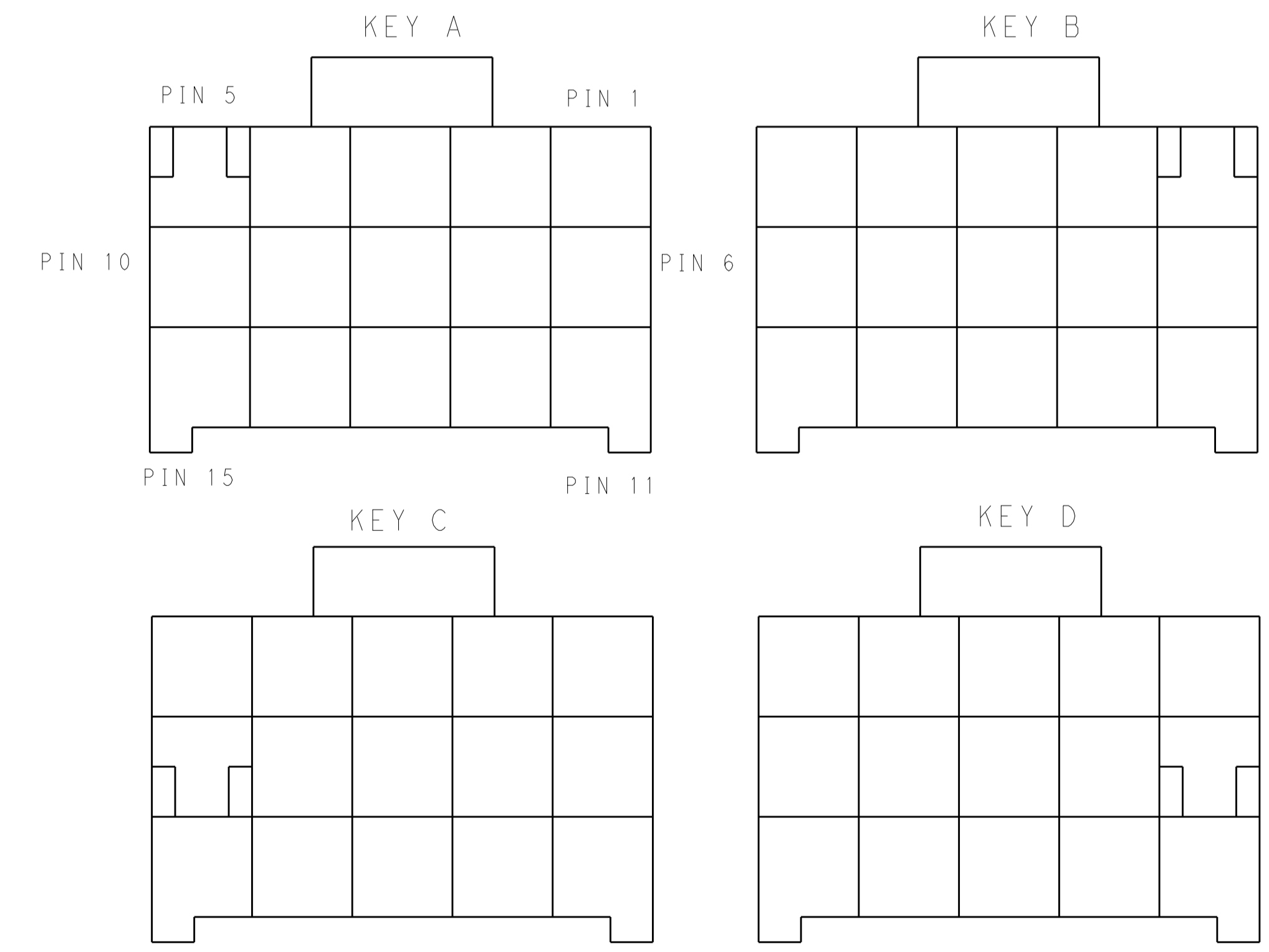

KEYING FOR 3*5 POS.

THIS DRAWING IS A CONTROLLED DOCUMENT.

DIMENSIONS: mm 	TOLERANCES UNLESS OTHERWISE SPECIFIED: 0 PLC ±. 1 PLC ±0.35 2 PLC ±0.25 3 PLC ±. 4 PLC ±. ANGLES ±. FINISH	DWN: TOMMY_WU 26MAR2013 CHK: HAPYE_WU 26MAR2013 APVD: YIHONG_MAO 26MAR2013 PRODUCT SPEC: 108-106118 APPLICATION SPEC: 114-106118 WEIGHT: - Customer Drawing	NAME: PLUG HOUSING, TRIPLE ROW POWER TRIPLE LOCK SIZE: A1 CAGE CODE: 00779 DRAWING NO: 2232357 RESTRICTED TO: - SCALE: - SHEET 2 OF 2 REV B1
-----------------------	---	---	---

4805 (3/11)

X-ON Electronics

Largest Supplier of Electrical and Electronic Components

Click to view similar products for [Hard Metric Connectors](#) category:

Click to view products by [TE Connectivity](#) manufacturer:

Other Similar products are found below :

[10146110-VR5C](#) [6345127-1](#) [646916-9](#) [6469658-1](#) [853016](#) [973108](#) [1-2000713-0](#) [1-2000713-2](#) [1-2000713-3](#) [120646-1](#) [134187](#) [1645343-1](#)
[1645456-1](#) [1645564-3](#) [1645594-1](#) [1645601-1](#) [1934822-1](#) [2000829-2](#) [2000985-2](#) [223085-1](#) [278071110010833](#) [1645179-1](#) [1645245-1](#)
[1645457-1](#) [1645525-1](#) [1645570-1](#) [1645596-1](#) [17-8072-125-000-863+](#) [1857470-1](#) [1934275-1](#) [1934289-1](#) [1934759-1](#) [2000670-2](#) [2000673-1](#)
[2000843-2](#) [2000984-2](#) [204975](#) [2170292-2](#) [2-536642-6](#) [3-100668-0](#) [3-106015-1](#) [352188-1](#) [352629-1](#) [3-646346-0](#) [3-646356-0](#) [3-646457-0](#) [3-646529-0](#) [3-646530-0](#) [5120823-1](#) [5120899-1](#)