

4

3

2

1

THIS DRAWING IS UNPUBLISHED. RELEASED FOR PUBLICATION 20  
 © COPYRIGHT 20 BY Tyco Electronics Japan G.K. ALL RIGHTS RESERVED.

LOC	DIST	REVISIONS					
		P	LTR	DESCRIPTION	DATE	DWN	APVD
J	-		D	REVISED	14JUL2010	HMR	TM
			E	ITEM ADDITION	13JUN2011	M.M	N.Y

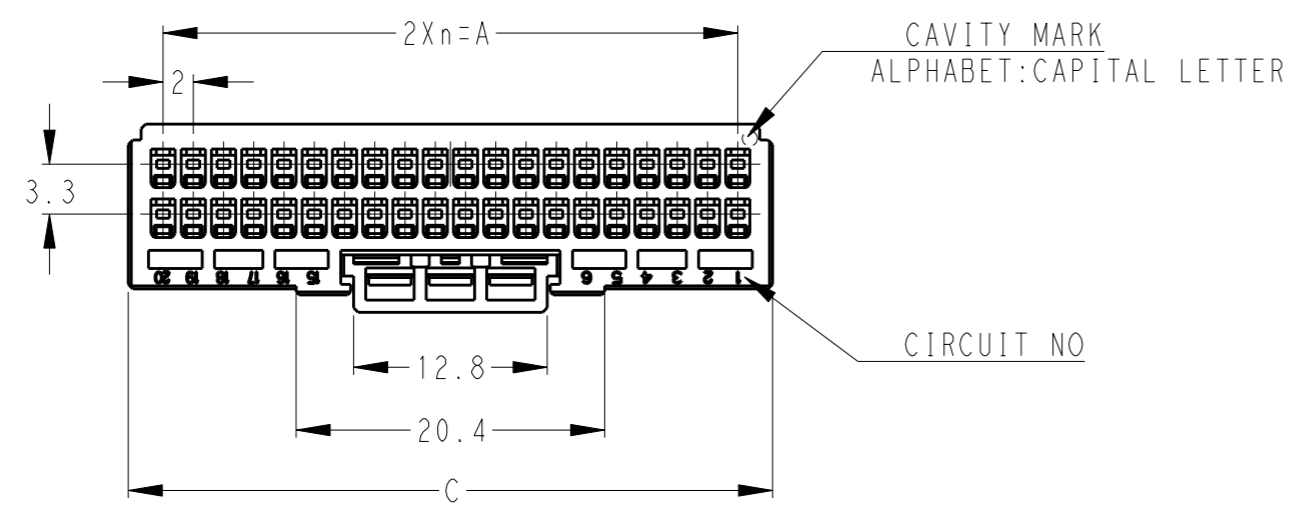

1 MATERIAL: GLASS FILED THERMO PLASTIC POLYESTER(94V-0)

2 COLOR: SEE TABLE

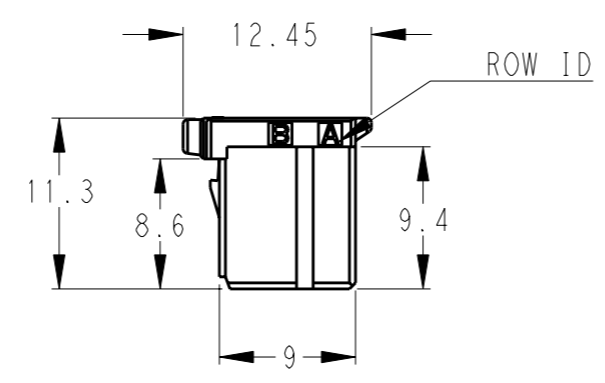
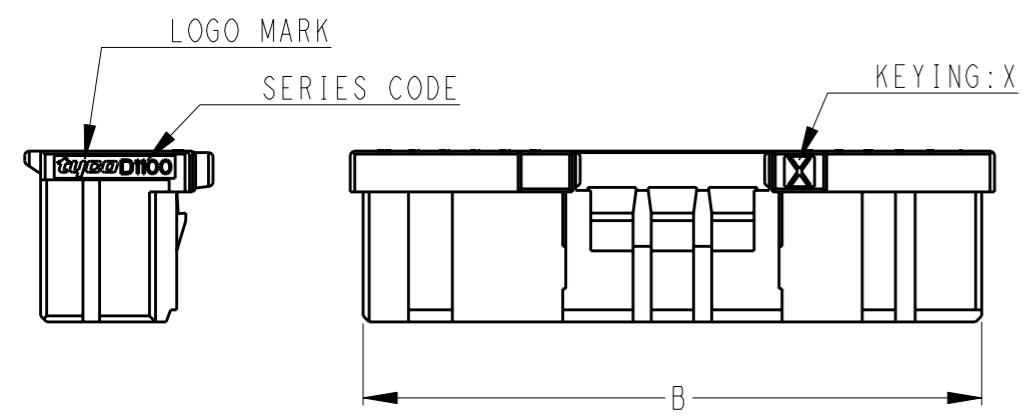

- 5-1871057-□ : RED (X-KEY)
- 3-1871057-□ : YELLOW (X-KEY)
- 1-1871057-□ : NATURAL (X-KEY)

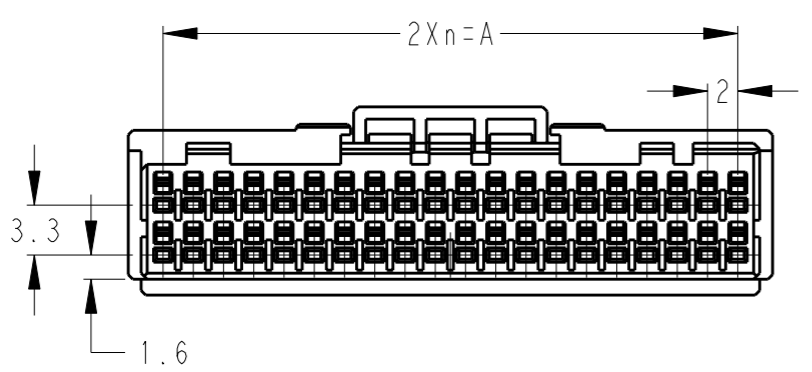

POS	KEY	n	A	B	C	COLOR	PART NO
40	X	19	38.0	40.9	42.6	RED	5-1871057-0
40	X	19	38.0	40.9	42.6	YELLOW	3-1871057-0
40	X	19	38.0	40.9	42.6	NATURAL	1-1871057-0
32	X	15	30.0	32.9	34.6	NATURAL	1-1871057-6
30	X	14	28.0	30.9	32.6	YELLOW	3-1871057-5
30	X	14	28.0	30.9	32.6	NATURAL	1-1871057-5
28	X	13	26.0	28.9	30.6	RED	5-1871057-4
26	X	12	24.0	26.9	28.6	NATURAL	1-1871057-3
24	X	11	22.0	24.9	26.6	YELLOW	3-1871057-2
22	X	10	20.0	22.9	24.6	YELLOW	3-1871057-1
22	X	10	20.0	22.9	24.6	NATURAL	1-1871057-1

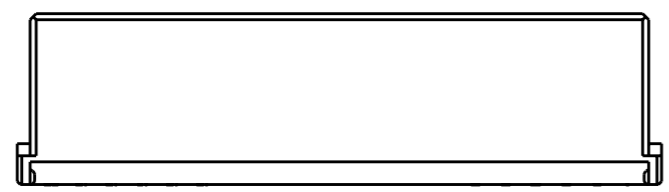

40POS(X-KEY):  
 1-1871057-0(NATURAL)  
 3-1871057-0(YELLOW)  
 5-1871057-0(RED)

THIS DRAWING IS A CONTROLLED DOCUMENT.		DWN T. KUDO 21APR2005	TE Connectivity	
DIMENSIONS: mm		CHK D. MITSUGI 23AUG2005		
TOLERANCES UNLESS OTHERWISE SPECIFIED: ±0.3, ±5°		APVD D. MITSUGI 23AUG2005	NAME DYNAMIC 1100D 2.0mmPITCH REC HSG COLOR 22-40POS	
0 PLC ± 1 PLC ±0.1 2 PLC ±0.02 3 PLC ±0.005 4 PLC ±0.0005 ANGLES ±		PRODUCT SPEC 108-78268, 78298	SIZE A3	
MATERIAL 1		APPLICATION SPEC 114-5377	CAGE CODE 00779	DRAWING NO C-1871057
FINISH -		WEIGHT -	RESTRICTED TO -	
CUSTOMER DRAWING			SCALE 2:1	SHEET 1 OF 3
			REV E	

THIS DRAWING IS UNPUBLISHED.

RELEASED FOR PUBLICATION

20

© COPYRIGHT 20

BY Tyco Electronics Japan G.K.

ALL RIGHTS RESERVED.

LOC	DIST	REVISIONS					
J	-	P	LTR	DESCRIPTION	DATE	DWN	APVD
				SEE SHEET 1 OF 2			

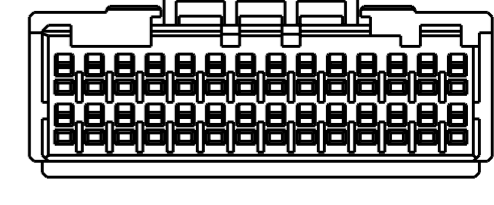
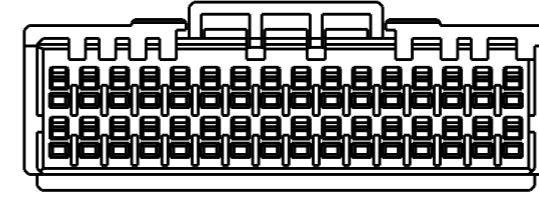
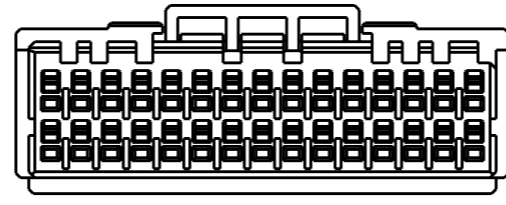
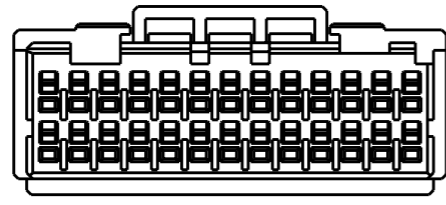
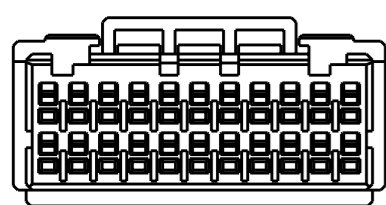
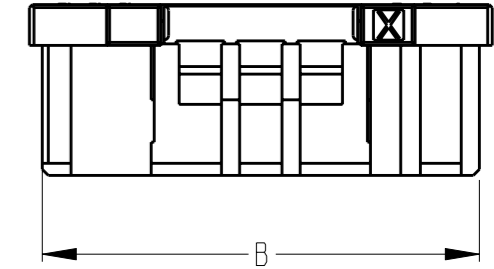
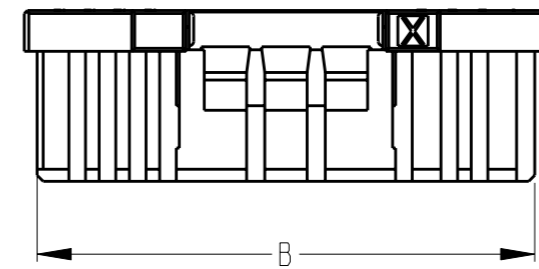
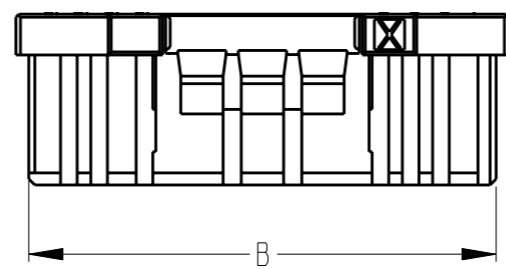
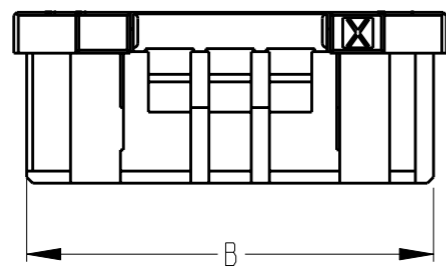
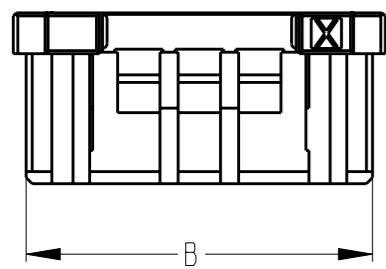
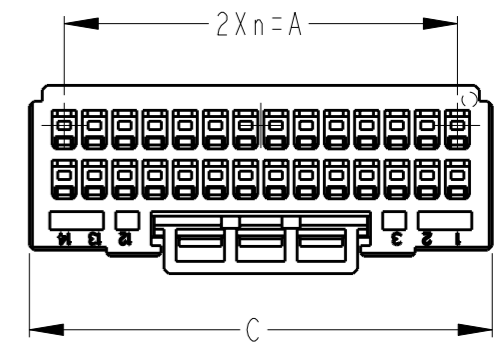
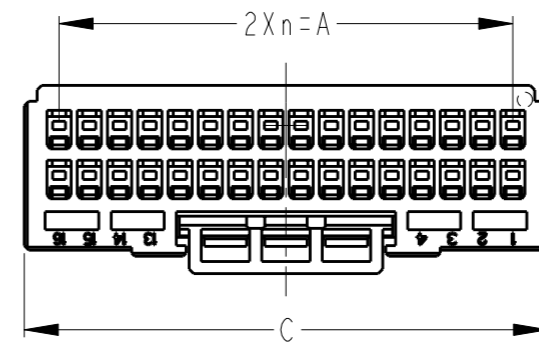
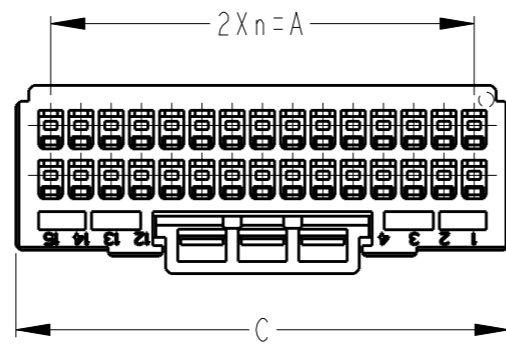
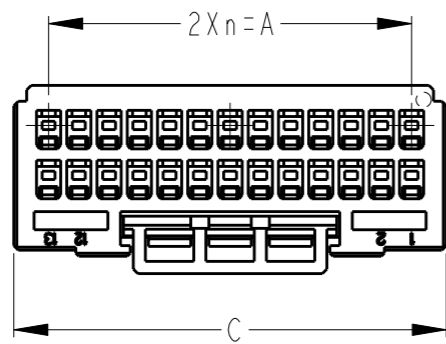
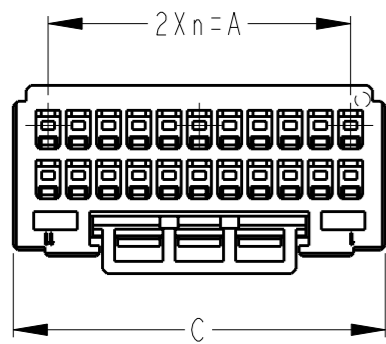

22POS(X-KEY):  
 1-1871057-1(NATURAL)  
 3-1871057-1(YELLOW)

26POS(X-KEY):  
 1-1871057-3(NATURAL)

30POS(X-KEY):  
 1-1871057-5(NATURAL)  
 3-1871057-5(YELLOW)

32POS(X-KEY):  
 1-1871057-6(NATURAL)

28POS(X-KEY):  
 5-1871057-4(RED)

THIS DRAWING IS A CONTROLLED DOCUMENT.		DWN T. KUDO 21APR2005	 TE Connectivity	
DIMENSIONS: mm		CHK D. MITSUGI 23AUG2005		
TOLERANCES UNLESS OTHERWISE SPECIFIED:		APVD D. MITSUGI 23AUG2005	NAME DYNAMIC 1100D 2.0mmPITCH REC HSG COLOR 22-40POS	
0 PLC ±-		PRODUCT SPEC 108-78268,78298	SIZE A3	
1 PLC ±0.1		APPLICATION SPEC 114-5377	CAGE CODE 00779	DRAWING NO C-1871057
2 PLC ±0.02		WEIGHT -	RESTRICTED TO -	
3 PLC ±0.005		CUSTOMER DRAWING	SCALE 2:1	SHEET 2 OF 3
4 PLC ±0.0005				REV E
ANGLES ±-				
MATERIAL -				
FINISH -				

SEE SHEET 1 OF 2

THIS DRAWING IS UNPUBLISHED.

RELEASED FOR PUBLICATION

20

© COPYRIGHT 20

BY Tyco Electronics Japan G.K.

ALL RIGHTS RESERVED.

LOC	DIST	REVISIONS			
P	LTR	DESCRIPTION	DATE	DWN	APVD
J	-	SEE SHEET 1 OF 2			

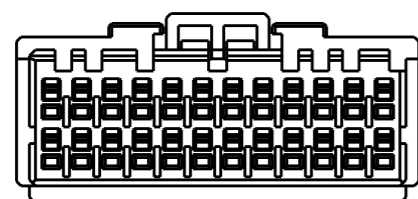
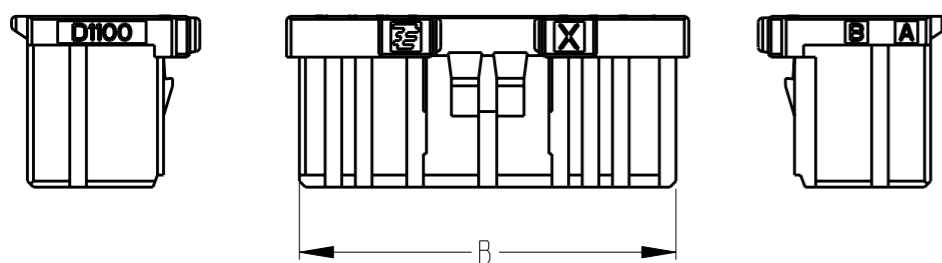
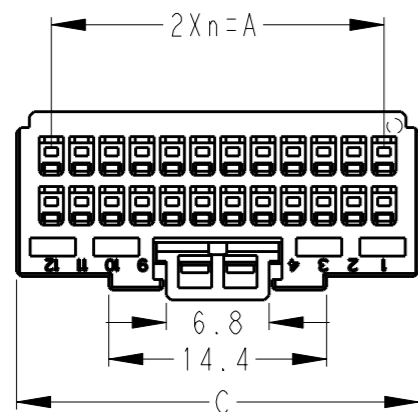

24POS(X-KEY):  
3-1871057-2(YELLOW)

THIS DRAWING IS A CONTROLLED DOCUMENT.

DIMENSIONS:	TOLERANCES UNLESS OTHERWISE SPECIFIED:
mm	
0 PLC	±-
1 PLC	±0.5
2 PLC	±0.13
3 PLC	±0.013
4 PLC	±0.0001
ANGLES	±-
MATERIAL	FINISH
-	-

SEE SHEET 1 OF 2

DWN	T. KUDO	21APR2005
CHK	D. MITSUGI	23AUG2005
APVD	D. MITSUGI	23AUG2005
PRODUCT SPEC	108-78268, 78298	
APPLICATION SPEC	114-5377	
WEIGHT	-	



NAME			
DYNAMIC 1100D 2.0mmPITCH REC HSG COLOR 22-40POS			
SIZE	CAGE CODE	DRAWING NO	RESTRICTED TO
A3	00779	C-1871057	-

CUSTOMER DRAWING SCALE 2:1 SHEET 3 OF 3 REV E

## X-ON Electronics

Largest Supplier of Electrical and Electronic Components

*Click to view similar products for [Headers & Wire Housings](#) category:*

*Click to view products by [TE Connectivity](#) manufacturer:*

Other Similar products are found below :

[95000-104TRLF](#) [10135584-644402LF](#) [DF62W-EP2022PCA](#) [95000-106TRLF](#) [DF62W-2022SCA](#) [DF62W-EP2022PC](#) [2203348](#) [DF62W-2022SC](#) [1084018](#) [1029039](#) [1084017](#) [802-10-012-10-002000](#) [1112640](#) [1112639](#) [000-34000](#) [0009482033](#) [0009507031](#) [57102-S06-03LF](#) [57202-S52-04LF](#) [PCN6-15S-2.5E](#) [0039019024](#) [58102-G61-06LF](#) [582553-1](#) [0009485154](#) [0009508121](#) [0022285053](#) [0050291907](#) [018731A](#) [LY20-4P-DT1-P1E-BR](#) [02.125.8002.8](#) [60101931](#) [60598-1 \(Cut Strip\)](#) [M1625-3R/100](#) [61062-3](#) [61082-181009](#) [636-1427](#) [638009-1](#) [641938-9](#) [641991-4](#) [644168-1](#) [647662-1](#) [65039-019ELF](#) [65817-002LF](#) [65817-015LF](#) [65863-015LF](#) [66207-023LF](#) [67016-026LF](#) [67046-001LF](#) [67095-007LF](#) [67230-005LF](#)