

RM94

miniature relays

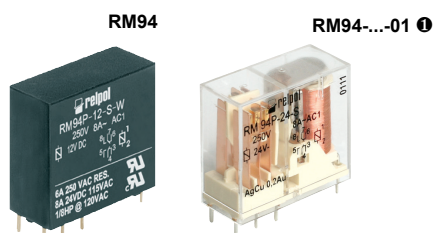

- Miniature dimensions
- General purpose relays
- Protection category IP 40 or IP 67
- For PCB and plug-in sockets
- DC coils - standard and sensitive
- Recognitions, certifications, directives: RoHS, EAC

Contact data

Number and type of contacts		2 CO, 2 NO, 2 NC
Contact material		AgCu/Au 0,2 μm , AgCdO, AgCdO/Au 3 μm
Rated / max. switching voltage	AC	250 V / 440 V
Min. switching voltage		10 V AgCu/Au 0,2 μm, 10 V AgCdO, 5 V AgCdO/Au 3 μm
Rated load	AC1	8 A / 250 V AC
	DC1	8 A / 24 V DC
Min. switching current		5 mA AgCu/Au 0,2 μm, 5 mA AgCdO, 2 mA AgCdO/Au 3 μm
Rated current		8 A
Max. breaking capacity	AC1	2 000 VA
Min. breaking capacity		0,5 W AgCu/Au 0,2 μm, 0,5 W AgCdO, 0,05 W AgCdO/Au 3 μm
Contact resistance		≤ 100 mΩ
Max. operating frequency		
• at rated load	AC1	600 cycles/hour
• no load		72 000 cycles/hour

Coil data

Rated voltage	DC	6 ... 110 V standard version	5 ... 110 V sensitive version
Must release voltage		DC: ≥ 0,1 U _n	
Operating range of supply voltage		see Tables 1, 2	
Rated power consumption	DC	0,8 W standard version	0,5 W sensitive version

Insulation according to PN-EN 60664-1

Insulation rated voltage		400 V AC
Dielectric strength		
• between coil and contacts		4 000 V AC type of insulation: reinforced
• contact clearance		1 000 V AC type of clearance: micro-disconnection
• pole - pole		2 500 V AC type of insulation: basic
Contact - coil distance		
• clearance		≥ 8 mm
• creepage		≥ 8 mm

General data

Operating / release time (typical values)		7 ms / 2 ms
Electrical life (number of cycles)		
• resistive AC1		> 2 x 10 ⁵ 8 A, 250 V AC
• cosφ		see Fig. 1
Mechanical life (cycles)		> 3 x 10 ⁷
Motor load according to UL 508		0,125 HP 120 V AC, single-phase motor
Dimensions (L x W x H)		IP 40: 28 x 12,5 x 26 mm IP 67: 28 x 12,5 x 26,5 mm
Weight		20 g
Ambient temperature	• storage	-40...+85 °C
	• operating	-40...+70 °C
Cover protection category		IP 40 or IP 67 PN-EN 60529
Shock resistance		20 g
Vibration resistance	(2 NO/2 NC)	10 g / 5 g 10...150 Hz
Solder bath temperature		max. 270 °C
Soldering time		max. 5 s

The data in bold type pertain to the standard versions of the relays.

❶ For special version - relays in transparent cover - see "Ordering codes".

RM94

miniature relays

Coil data - DC voltage version, standard

Table 1

Coil code	Rated voltage V DC	Coil resistance at 20 °C Ω	Acceptable resistance	Coil operating range V DC	
				min. (at 20 °C)	max. (at 20 °C)
1006	6	47	± 10%	3,9	8,5
1012	12	170	± 10%	7,9	16,2
1024	24	740	± 10%	16,8	33,6
1036	36	1 350	± 10%	22,0	45,5
1048	48	3 200	± 10%	34,0	70,0
1060	60	5 000	± 10%	42,0	87,0
1096	96	10 000	± 10%	61,0	125,0
1110	110	13 000	± 10%	77,0	140,0

The data in bold type pertain to the standard versions of the relays.

Coil data - DC voltage version, sensitive

Table 2

Coil code	Rated voltage V DC	Coil resistance at 20 °C Ω	Acceptable resistance	Coil operating range V DC	
				min. (at 20 °C)	max. (at 20 °C)
S005	5	47	± 10%	3,5	8,5
S006	6	70	± 10%	4,4	10,3
S012	12	270	± 10%	8,8	20,3
S024	24	1 100	± 10%	17,5	41,0
S036	36	2 000	± 10%	24,0	55,0
S048	48	4 400	± 10%	35,0	82,0
S060	60	6 500	± 10%	44,0	100,0
S110	110	20 000	± 10%	88,0	188,0

The data in bold type pertain to the standard versions of the relays.

Dimensions

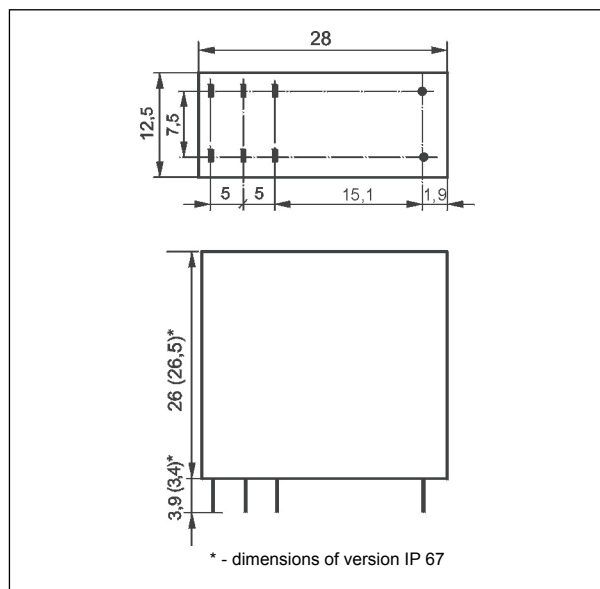

Connection diagrams (pin side view)

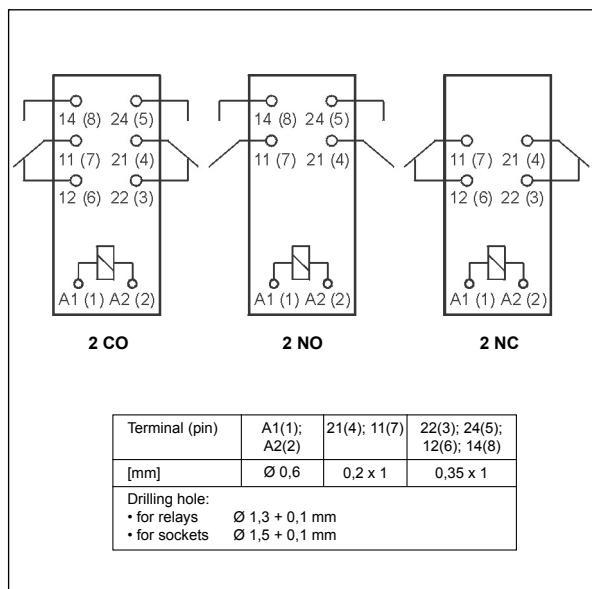

Mounting

Relays **RM94** are designed for: • direct PCB mounting • plug-in sockets for PCB mounting **EC 50** with clip **MP25-2**, **MH25-2**, **GD-0025**, **RM81-0001**; plug-in sockets **PW80** with clip **MH25-2**, **GD-0025**, **RM81-0001**; plug-in sockets **GD50** with clip **MP25-2**, **GD-0025**, **MH25-2**, **RM81-0001**.

Electrical life reduction factor at AC inductive load

Fig. 1

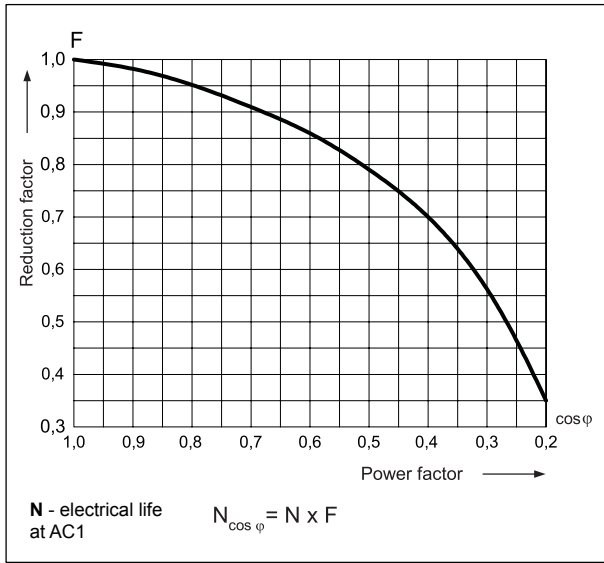

Max. breaking capacity
A - resistive load DC1
B - resistive load AC1

Fig. 2

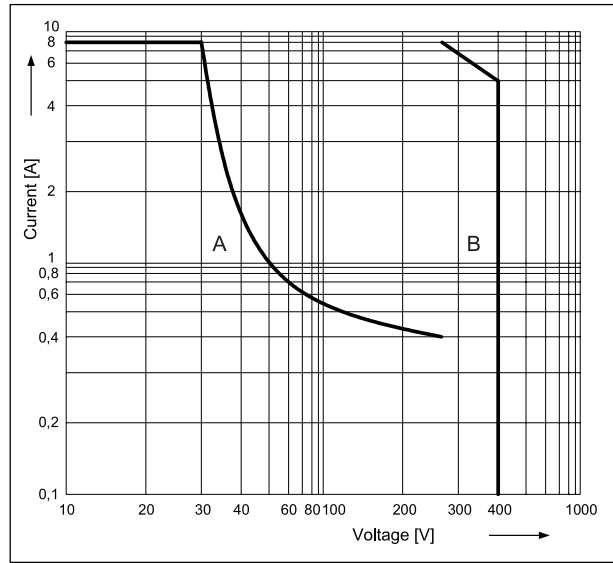

Coil temperature rise - standard version

Fig. 3

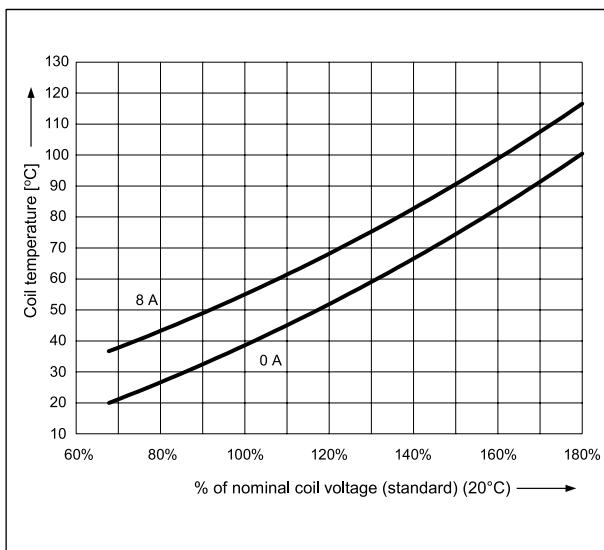

Coil temperature rise - sensitive version

Fig. 4

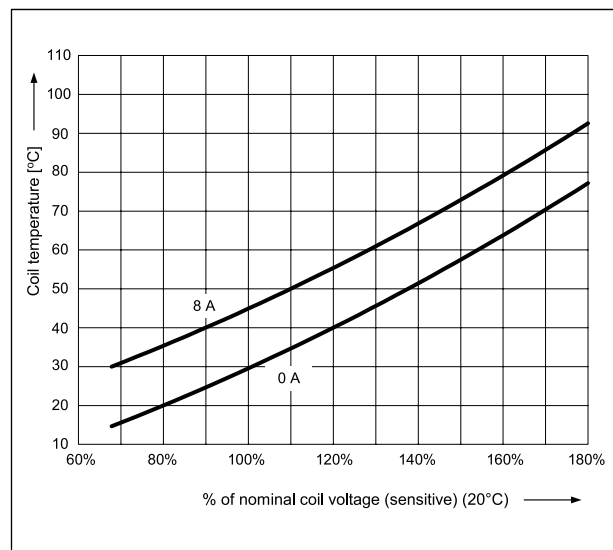

Pinout (solder side view)

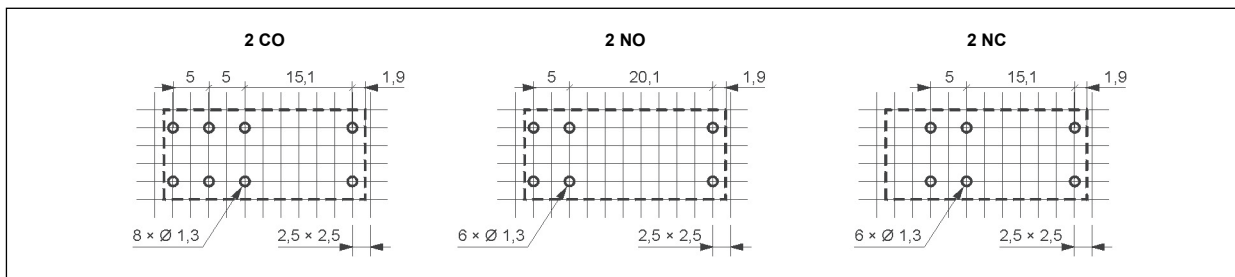

RM94

miniature relays

Ordering codes

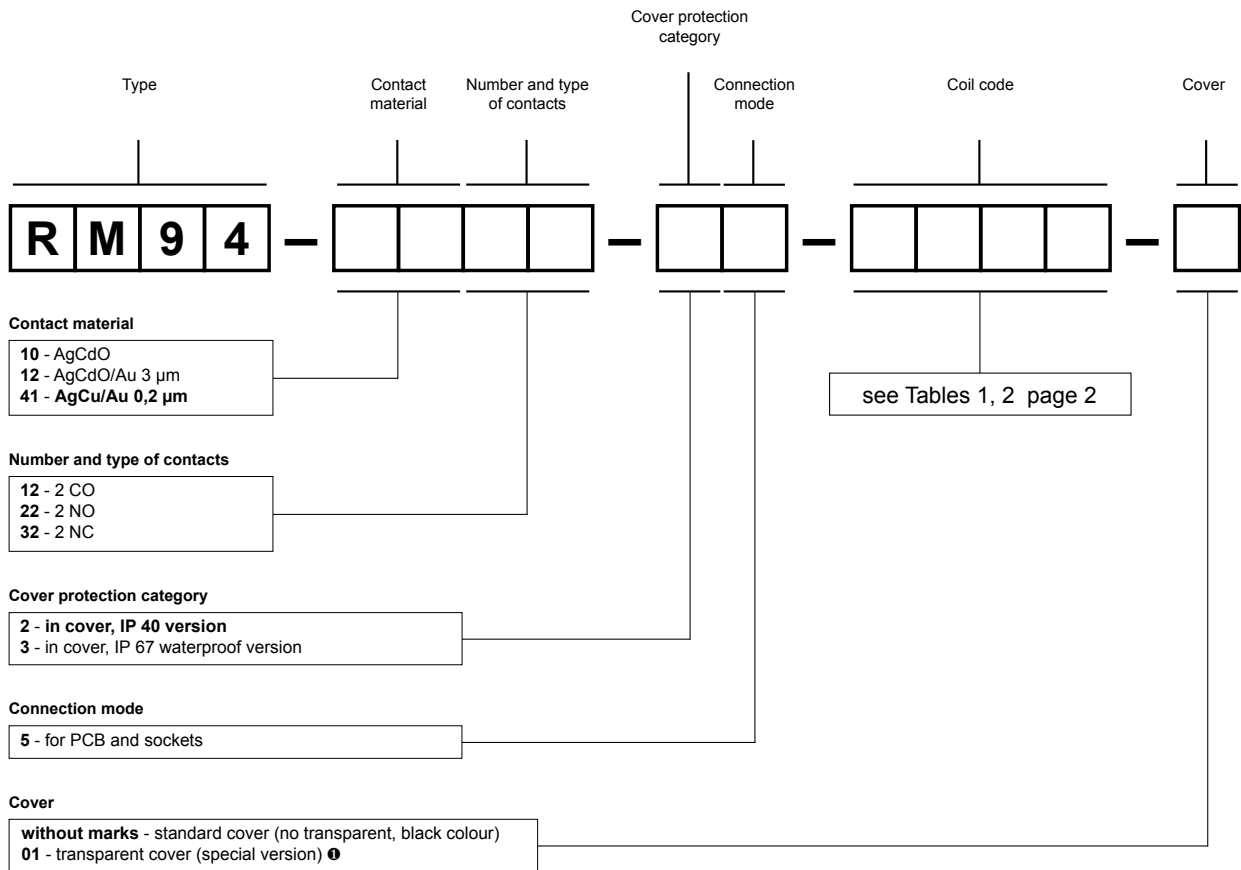

Examples of ordering codes:

RM94-4112-25-1024

relay **RM94**, for PCB and sockets, two changeover contacts, contact material AgCu/Au 0,2 µm, coil voltage 24 V DC, in standard cover (no transparent, black colour) IP 40

RM94-4122-35-S024

relay **RM94**, for PCB and sockets, two normally open contacts, contact material AgCu/Au 0,2 µm, sensitive coil voltage 24 V DC, in standard cover (no transparent, black colour) IP 67

RM94-4132-35-1012-01

relay **RM94**, for PCB and sockets, two normally closed contacts, contact material AgCu/Au 0,2 µm, coil voltage 12 V DC, in transparent cover (special version) IP 67

Print on relay cover

Type marking on relays cover **RM94** do not match the ordering codes (example of marking for **RM94-1012-35-S024**).

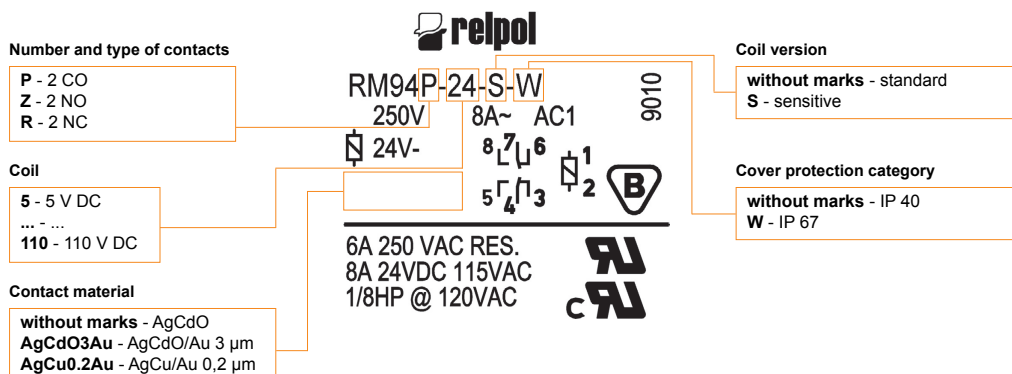

Plug-in sockets and accessories

EC 50

For RM84, RM85, RM85 inrush, RM85 105 °C sensitive, RMB841, RMB851, RM87L, RM87L sensitive, RM87P, RM87P sensitive, RM83, RM94

For PCB
31,3 x 12,7 x 9 mm
Two poles, 5 mm pinout
8 A, 300 V AC

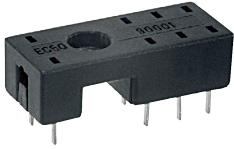

Pinout

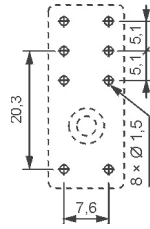

Dimensions

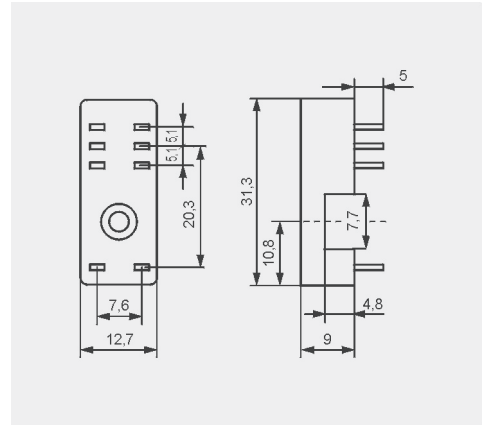

PW80

For RM84, RM85, RM85 inrush, RM85 105 °C sensitive, RMB841, RMB851, RM87L, RM87L sensitive, RM87P, RM87P sensitive, RM83, RM94

For PCB
34,6 x 12,9 x 6,6 mm
Two poles, 5 mm pinout
8 A, 250 V AC

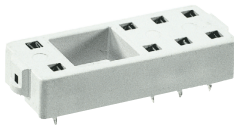

Pinout

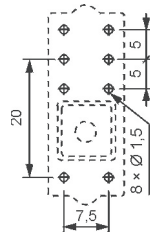

Dimensions

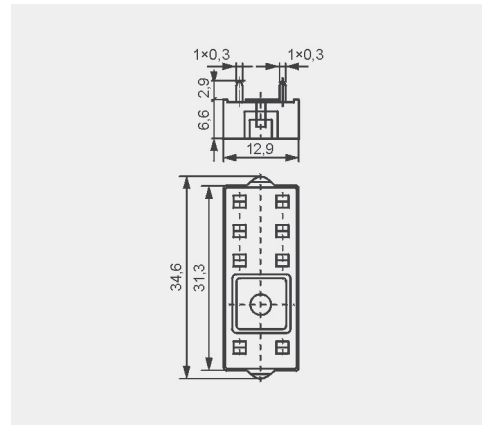

GD50

For RM84, RM85, RM85 inrush, RM85 105 °C sensitive, RMB841, RMB851, RM87L, RM87L sensitive, RM87P, RM87P sensitive, RM83, RM94

For PCB
31,5 x 13 x 9 mm
Two poles, 5 mm pinout
8 A, 300 V AC



Pinout

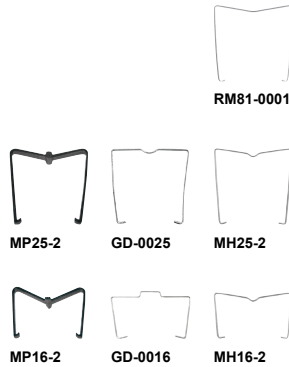
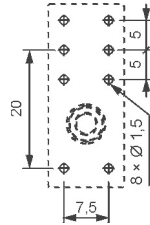

Dimensions

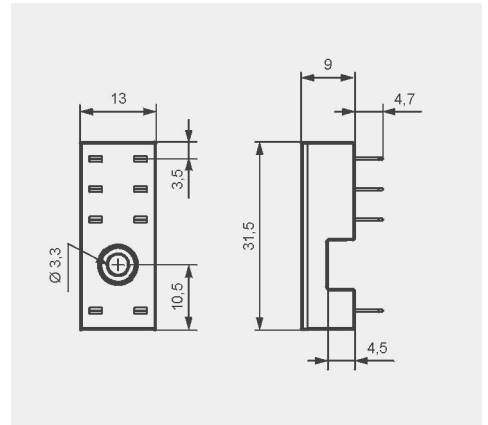

PRECAUTIONS:

1. Ensure that the parameters of the product described in its specification provide a safety margin for the appropriate operation of the device or system and never use the product in circumstances which exceed the parameters of the product. 2. Never touch any live parts of the device. 3. Ensure that the product has been connected correctly. An incorrect connection may cause malfunction, excessive heating or risk of fire. 4. In case of any risk of any serious material loss or death or injuries of humans or animals, the devices or systems shall be designed so to equip them with double safety system to guarantee their reliable operation.

X-ON Electronics

Largest Supplier of Electrical and Electronic Components

Click to view similar products for [General Purpose Relays](#) category:

Click to view products by [Relpol](#) manufacturer:

Other Similar products are found below :

[APF30318](#) [JVN1AF-4.5V-F](#) [PCN-105D3MHZ](#) [5JO-10000S-SIL](#) [5JO-1000CD-SIL](#) [5JO-400CD-SIL](#) [LY2S-AC220/240](#) [LYQ20DC12](#)
[6031007G](#) [6131406HQ](#) [6-1393099-3](#) [6-1393099-8](#) [6-1393122-4](#) [6-1393123-2](#) [6-1393767-1](#) [6-1393843-7](#) [6-1415012-1](#) [6-1419102-2](#) [6-](#)
[1423698-4](#) [6-1608051-6](#) [6-1608067-0](#) [6-1616170-6](#) [6-1616248-2](#) [6-1616282-3](#) [6-1616348-2](#) [6-1616350-1](#) [6-1616350-8](#) [6-1616358-7](#) [6-](#)
[1616359-9](#) [6-1616360-9](#) [6-1616931-6](#) [6-1617039-1](#) [6-1617052-1](#) [6-1617090-2](#) [6-1617090-5](#) [6-1617347-5](#) [6-1617353-3](#) [6-1617801-8](#) [6-](#)
[1617802-2](#) [6-1618107-9](#) [6-1618248-4](#) [M83536/1-027M](#) [CX-4014](#) [MAHC-5494](#) [MAVCD-5419-6](#) [703XCX-120A](#) [7-1393100-5](#) [7-1393111-7](#)
[7-1393144-5](#) [7-1393767-8](#)