

A6 Series – Miniature Switches and Pilot Devices: 16mm

Key features:

- 16mm (5/8") mounting hole
- LED illumination
- Compact design saves space
- Momentary, Maintained, Selectors, and E-Stops
- Gold-clad Silver contacts for reliable low level switching
- Snap action contacts
- IP40 (dustproof) or IP65 (oiltight) versions



| | | | | | |
|-------------------------|--------------------------------|--|--|--------------------|--------------------|
| Specifications | Degree of Protection | IP40: Dustproof IP65 Watertight/Oiltight | | | |
| | Contact Configuration | SPDT, DPDT | | | |
| | Maximum Voltage | 250V AC/DC | | | |
| | Thermal Current | 3A | | | |
| | Minimum Applicable Load | 5V AC/DC, 1mA | | | |
| | Contact Material | Gold-clad silver | | | |
| | Terminal Style | .110" Solder/ Quick Connect | | | |
| | Operating Temperature | -25° to +55°C (no freezing) | | | |
| | Operating Humidity | 45 to 85% RH | | | |
| | Contact Resistance | 50mΩ maximum (initial value) | | | |
| | Insulation Resistance | 100MΩ minimum (500V DC megger) | | | |
| | Vibration Resistance | 10 to 55Hz, amplitude 1.5mm p-p | | | |
| | Shock Resistance | Damage limits: 500m/sec ² (approx. 50G) Operating extremes: 200m/sec ² (approx. 20G) | | | |
| | Electrical Life | 100,000 operations minimum (at full rated load) | | | |
| Contact Ratings | Operating Voltage | 24V | 120V | 240V | |
| | AC (50/60Hz) | Resistive | — | 1.0A | 0.5A |
| Inductive | | — | 0.7A | 0.5A | |
| DC | Resistive | 1.0A | 0.2A | — | |
| | Inductive | 0.7A | 0.1A | — | |
| LED Lamp Ratings | Rated Voltage/Current | 5V DC ±5% | 6V AC/DC (±10%) | 12V AC/DC (±10%) | 24V AC/DC (±10%) |
| | | 8mA | AC: A, R, W, Y: 8mA G, S: 7mA DC: A, R, W, Y: 6mA G, S: 5mA | AC: 9mA DC: 8mA | AC: 9mA DC: 8mA |

1. AC Inductive Load, PF = 0.6 – 0.7; DC Inductive Load, L/R = 7ms.
2. LED lamp contains a built-in current limiting resistor and a protection diode.
3. LED's don't "burn out." Luminance is reduced to 50% of initial intensity after being lit for 50,000 hours continuously.

Switches & Pilot Lights

Display Lights

Relays & Sockets

Timers

Terminal Blocks

Circuit Breakers

AB6 Non-Illuminated Pushbuttons (Assembled)

Non-Illuminated Pushbuttons

| Style | Contact | Part Number | | | |
|--|--------------|------------------------|----------------------------|------------------------|----------------------------|
| | | Momentary | | Maintained (Latching) | |
| | | Dustproof (IP40) | Oiltight (IP65) | Dustproof (IP40) | Oiltight (IP65) |
| Round 18mm  | SPDT DPDT | AB6M-M1-⓪ AB6M-M2-⓪ | AB6M-M1P-⓪ AB6M-M2P-⓪ | AB6M-A1-⓪ AB6M-A2-⓪ | AB6M-A1P-⓪ AB6M-A2P-⓪ |
| Square 18mm  | SPDT DPDT | AB6Q-M1-⓪ AB6Q-M2-⓪ | AB6Q-M1P-⓪ AB6Q-M2P-⓪ | AB6Q-A1-⓪ AB6Q-A2-⓪ | AB6Q-A1P-⓪ AB6Q-A2P-⓪ |
| Rectangular 18mm x 24mm  | SPDT DPDT | AB6H-M1-⓪ AB6H-M2-⓪ | AB6H-M1P-⓪ AB6H-M2P-⓪ | AB6H-A1-⓪ AB6H-A2-⓪ | AB6H-A1P-⓪ AB6H-A2P-⓪ |
| Round 23.5mm  | SPDT DPDT | - | AB6M-M1P-M⓪ AB6M-M2P-M⓪ | - | AB6M-A1P-M⓪ AB6M-A2P-M⓪ |
| Square 23.5mm  | SPDT DPDT | - | AB6Q-M1P-Q⓪ AB6Q-M2P-Q⓪ | - | AB6Q-A1P-Q⓪ AB6Q-A2P-Q⓪ |
| Rectangular 17.5 X 23.5mm  | SPDT DPDT | - | AB6Q-M1P-H⓪ AB6Q-M2P-H⓪ | - | AB6Q-A1P-H⓪ AB6Q-A2P-H⓪ |

⓪ Button Color Code

| Color | Code |
|--------|------|
| Black | B |
| Green | G |
| Red | R |
| Blue | S |
| White | W |
| Yellow | Y |



1. In place of ⓪, specify Button Color Code from the table at right.
2. To order as sub-assembled, see page 459.
3. For accessories, see page 466.
4. For dimensions, see page 468.

AB6-V Pushlock Turn Reset

| Shape | Operation | Contact | Part Number | | Remarks |
|--|---------------------|--------------|------------------------|--------------------------|---|
| | | | Dustproof (IP40) | Oiltight (IP65) | |
| 23.5mm Round Mushroom  | Pushlock Turn Reset | SPDT DPDT | AB6M-V1-R AB6M-V2-R | AB6M-V1P-R AB6M-V2P-R | 1. Button available in red only. 2. Replacement button: order AB6M-V-R |

Buzzer

| Style | Shape | Voltage | Part Number |
|---|--------------|---------|-------------|
|  | Round (18mm) | 12V DC | UZ6-11 |
| | | 24V DC | UZ6-12 |

Buzzer Ratings

| | |
|-----------------------|---|
| Frequency | 2 kHz ± 500 Hz |
| Amplitude | 80db @ 0.1m (at rated voltage) |
| Operating Voltage | 6V AC/DC or 12 - 24V AC/DC ± 10% |
| Adjustable Cycle | 55 to 600 cycles per minute |
| Current Draw | DC: 7mA, AC: 20mA |
| Life | 1000 hrs. minimum |
| Insulation Voltage | 60V AC/DC |
| Operating Temperature | -20 to 55 C (no freezing), 45 to 85% rh |

Switches & Pilot Lights

Display Lights

Relays & Sockets

Timers

Terminal Blocks

Circuit Breakers

AB6 Non-Illuminated Pushbuttons (Sub-Assembled)

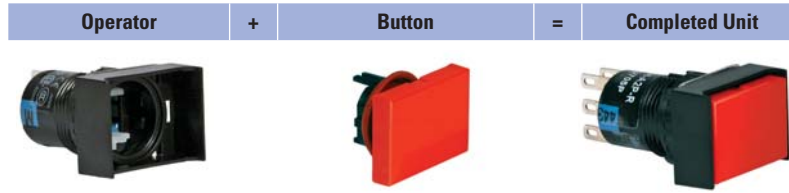

Operators

| Style | Contact | Operator | Part Number | | |
|--|---------|------------|-------------|-----------|-------------|
| | | | Round | Square | Rectangular |
| Non-Illuminated Pushbuttons  | SPDT | Momentary | AB6M-M100 | AB6Q-M100 | AB6H-M100 |
| | | Maintained | AB6M-A100 | AB6Q-A100 | AB6H-A100 |
| | DPDT | Momentary | AB6M-M200 | AB6Q-M200 | AB6H-M200 |
| | | Maintained | AB6M-A200 | AB6Q-A200 | AB6H-A200 |

 Oversize rectangular button uses square operator.

Buttons

| Description | Part Number | |
|---|------------------|-----------------|
| | Button | |
| | Dustproof (IP40) | Oiltight (IP65) |
| Round  | AB6M-BK1-① | AB6M-BK2-① |
| Square  | AB6Q-BK1-① | AB6Q-BK2-① |
| Rectangular  | AB6H-BK1-① | AB6H-BK2-① |
| Round Oversize  | — | AB6M-BK2-M① |
| Square Oversize  | — | AB6Q-BK2-Q① |
| Rectangular Oversize  | — | AB6Q-BK2-H① |

① Button Color Code

| Color | Code |
|--------|------|
| Black | B |
| Green | G |
| Red | R |
| Blue | S |
| White | W |
| Yellow | Y |

-  1. In place of ①, specify Button Color Code from table.
 2. Buttons which are rated IP65 include a waterproof rubber gasket.
 3. For accessories, see page 466.

AL6 Illuminated Pushbuttons (Assembled)

LED Illuminated Pushbuttons

| Description | Style | Contact | Part Numbers | | | |
|--|--------------------------------|--------------|--------------------------|------------------------------|--------------------------|------------------------------|
| | | | Momentary | | Maintained (Latching) | |
| | | | Dustproof (IP40) | Oiltight (IP65) | Dustproof (IP40) | Oiltight (IP65) |
| Standard Lens  | Round (18mm lens) | SPDT DPDT | AL6M-M1③-② AL6M-M2③-② | AL6M-M1③P-② AL6M-M2③P-② | AL6M-A1③-② AL6M-A2③-② | AL6M-A1③P-② AL6M-A2③P-② |
| | Square (18mm lens) | SPDT DPDT | AL6Q-M1③-② AL6Q-M2③-② | AL6Q-M1③P-② AL6Q-M2③P-② | AL6Q-A1③-② AL6Q-A2③-② | AL6Q-A1③P-② AL6Q-A2③P-② |
| | Rectangular (18mm x 24mm lens) | SPDT DPDT | AL6H-M1③-② AL6H-M2③-② | AL6H-M1③P-② AL6H-M2③P-② | AL6H-A1③-② AL6H-A2③-② | AL6H-A1③P-② AL6H-A2③P-② |
| Oversize Lens  | Round (24mm lens) | SPDT DPDT | - | AL6M-M1③P-M② AL6M-M2③P-M② | - | AL6M-A1③P-M② AL6M-A2③P-M② |
| | Square (24mm lens) | SPDT DPDT | - | AL6Q-M1③P-Q② AL6Q-M2③P-Q② | - | AL6Q-A1③P-Q② AL6Q-A2③P-Q② |
| | Rectangular (18mm x 24mm lens) | SPDT DPDT | - | AL6Q-M1③P-H② AL6Q-M2③P-H② | - | AL6Q-A1③P-H② AL6Q-A2③P-H② |

- 1. In place of ②, specify Lens/LED Color Code from table below.
- 2. In place of ③, specify Voltage Code from table below.
- 3. Lamps also available in 5V DC, 6V AC/DC or 12 V AC/DC, change "4" using voltage/lamp codes (ie AL6M-M13-② uses 12V AC/DC LED).
- 4. LED lamp is included in unit and contains a current-limiting resistor and a protection diode. (External resistor not required.)
- 5. To order as sub-assembled, see page 461.
- 6. For accessories, see page 466.
- 7. For dimensions, see page 468.
- 8. Light independent of switch position.

② Lens/LED Color Code

| Color | Code |
|------------|------|
| Amber | A |
| Green | G |
| Red | R |
| Blue | S |
| Warm White | W |
| Cool White | JW |
| Yellow | Y |

③ Voltage Code

| Voltage | Code |
|-----------|------|
| 5V DC | 1 |
| 6V AC/DC | 2 |
| 12V AC/DC | 3 |
| 24V AC/DC | 4 |

Switches & Pilot Lights
Display Lights
Relays & Sockets
Timers
Terminal Blocks
Circuit Breakers

AL6 Illuminated Pushbuttons (Sub-Assembled)

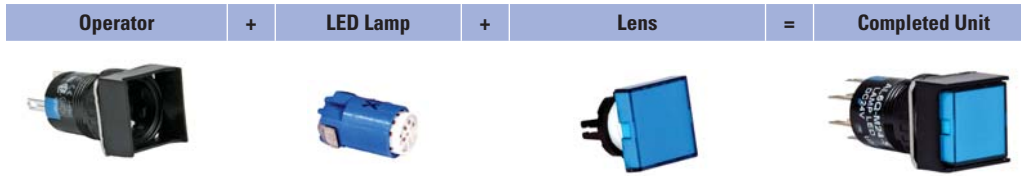

Operators

| Style | Contact | Operator | Part Number | | |
|---------------------------------|---------|------------|-------------|-----------|-------------|
| | | | Round | Square | Rectangular |
| AL6 Illuminated Pushbuttons | SPDT | Momentary | AL6M-M100 | AL6Q-M100 | AL6H-M100 |
| | | Maintained | AL6M-A100 | AL6Q-A100 | AL6H-A100 |
| | DPDT | Momentary | AL6M-M200 | AL6Q-M200 | AL6H-M200 |
| | | Maintained | AL6M-A200 | AL6Q-A200 | AL6H-A200 |

Oversize rectangular button uses square operator.

Lenses

| Unit | Part Number | | |
|-------------|------------------|-----------------|------------------|
| | Dustproof (IP40) | Oiltight (IP65) | |
| | Standard | Standard | Oversize |
| Round | AL6M-LK1-Ⓢ | AL6M-LK2-Ⓢ | AL6M-LK2-M Ⓢ |
| Square | AL6Q-LK1-Ⓢ | AL6Q-LK2-Ⓢ | AL6Q-LK2-Q Ⓢ |
| Rectangular | AL6H-LK1-Ⓢ | AL6H-LK2-Ⓢ | AL6Q-LK2-H Ⓢ |

- 1. In place of Ⓢ, specify Lens Color Code from table below.
- 2. Lenses which are rated IP65 include a waterproof rubber gasket.
- 3. For accessories, see page 466.

Ⓢ Lens/LED Color Code

| Color | Code |
|------------|------|
| Amber | A |
| Green | G |
| Red | R |
| Blue | S |
| Warm White | W |
| Cool White | JW |
| Yellow | Y |

LED Lamps

| Appearance | Rated Voltage | Part Number |
|------------|---------------|-------------|
| | 5V DC | LATD-5 Ⓢ |
| | 6V AC/DC | LATD-6 Ⓢ |
| | 12V AC/DC | LATD-1 Ⓢ |
| | 24V AC/DC | LATD-2 Ⓢ |

- 1. In place of Ⓢ, specify LED Color Code from table at left.

AL6 Pilot Lights (Assembled)

LED Pilot Lights

| Description | Part Number | |
|---|------------------|-----------------|
| | Dustproof (IP40) | Oiltight (IP65) |
| Round (18mm Lens)  | AL6M-P③-② | AL6M-P③P-② |
| Square (18mm Lens)  | AL6Q-P③-② | AL6Q-P③P-② |
| Rectangular (18mm x 24mm Lens)  | AL6H-P③-② | AL6H-P③P-② |

-  1. In place of ②, specify Lens Color Code from table below.
 2. In place of ③, specify Voltage Code from table below.
 3. LEDs also available in 5V DC, 6V AC/DC or 12 V AC/DC, change "4" using voltage codes (ie AL6M-P3-② uses 12V AC/DC LED).
 4. LED is included and contains built-in current limiting resistor and reverse polarity protection diode. (no external resistor required)
 5. To order sub-assembled, see page 463.
 6. For accessories, see page 466.
 7. For dimensions, see page 468.
 8. For one piece pilot lights and/or dome lens pilot lights, see AP series miniature pilot lights.

② Lens/LED Color Code

| Color | Code |
|------------|------|
| Amber | A |
| Green | G |
| Red | R |
| Blue | S |
| Warm White | W |
| Cool White | JW |
| Yellow | Y |

③ Voltage Code

| Voltage | Code |
|-----------|------|
| 5V DC | 1 |
| 6V AC/DC | 2 |
| 12V AC/DC | 3 |
| 24V AC/DC | 4 |

Switches & Pilot Lights

Display Lights

Relays & Sockets

Timers

Terminal Blocks

Circuit Breakers

AL6 Pilot Lights (Sub-Assembled)



Operators

| Style | Part Number | | |
|----------------------|-------------|----------|-------------|
| | Round | Square | Rectangular |
| AL6 Pilot Lights | AL6M-P00 | AL6Q-P00 | AL6H-P00 |

Lenses

| Degree of Protection | Part Number | |
|----------------------|----------------|----------------|
| | Dustproof IP40 | Oiltight IP65 |
| Round | AL6M-LK1-Ⓢ | AL6M-LK3-Ⓢ |
| Square | AL6Q-LK1-Ⓢ | AL6Q-LK3-Ⓢ |
| Rectangular | AL6H-LK1-Ⓢ | AL6H-LK3-Ⓢ |

- 1. In place of Ⓢ, specify Lens Color Code from table below.
- 2. Lenses which are rated IP65 include a waterproof rubber gasket.
- 3. For accessories, see page 466.

Ⓢ Lens/LED Color Code

| Color | Code |
|------------|------|
| Amber | A |
| Green | G |
| Red | R |
| Blue | S |
| Warm White | W |
| Cool White | JW |
| Yellow | Y |



LED Lamps

| Appearance | Rated Voltage | Part Number |
|------------|---------------|-------------|
| | 5V DC | LATD-5 Ⓢ |
| | 6V AC/DC | LATD-6 Ⓢ |
| | 12V AC/DC | LATD-1 Ⓢ |
| | 24V AC/DC | LATD-2 Ⓢ |

- 1. In place of Ⓢ, specify LED Color Code from table at left.



AS6 Selector and Keylock Switches

AS6 Selector Switches and Keylock Switches (2 & 3 Position)

| Style | Function | Knob | Key |
|---|--|---|---|
| Round Selector  | 2-Position 90° Maintained |  | AS6M-2Y2P |
| | 2-Position 90° Spring Return Right |  | AS6M-21Y2P |
| Round Keylock  | 3-Position 45° Maintained |  | AS6M-3Y2P |
| | 3-Position 45° Spring Return Right → Center |  | AS6M-31Y2P |
| | 3-Position 45° Spring Return Left → Center |  | AS6M-32Y2P |
| Square Selector  | 2-Position 90° Maintained |  | AS6Q-2Y2P |
| | 2-Position 90° Spring Return to Right |  | AS6Q-21Y2P |
| | Square Keylock  | 3-Position 45° Maintained |  |
| 3-Position 45° Spring Return Right → Center | |  | AS6Q-31Y2P |
| 3-Position 45° Spring Return Left → Center | |  | AS6Q-32Y2P |
| Rectangular Selector  | 2-Position 90° Maintained |  | AS6H-2Y2P |
| | 2-Position 90° Spring Return Right |  | AS6H-21Y2P |
| | Rectangular Keylock  | 3-Position 45° Maintained |  |
| 3-Position 45° Spring Return Right → Center | |  | AS6H-31Y2P |
| 3-Position 45° Spring Return Left → Center | |  | AS6H-32Y2P |
| Round Selector  | 2-Position 90° 2-Way Return → Center |  | AS6M-33Y2P |
| | 2-Position 90° 2-Way Return → Center |  | AS6M-33KT2P |
| Square Selector  | 2-Position 90° 2-Way Return → Center |  | AS6Q-33Y2P |
| | 2-Position 90° 2-Way Return → Center |  | AS6Q-33KT2P |
| Rectangular Selector  | 2-Position 90° 2-Way Return → Center |  | AS6H-33Y2P |
| | 2-Position 90° 2-Way Return → Center |  | AS6H-33KT2P |

Contact Operations

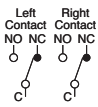
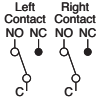
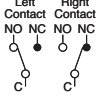
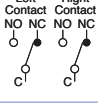
(for all selectors)

| Contents | Operator Position & Contact Operation |
|---------------|---|
| 2-pos. (DPDT) | Left  |
| | Right  |
| 3-pos. (DPDT) | Left  |
| | Center  |
| | Right  |

Key Retention Codes

| Code | Description |
|------|---|
| A | Key not retained in any position (removable in all positions) |
| B | Key retained in right position only |
| C | Key retained in left position only |
| D | Key retained in left and right (3 position only) |
| E | Key retained in center only (3 position only) |
| G | Key retained right and center (3 position only) |
| H | Key retained left and center (3 position only) |

 Key cannot be removed in a spring return position.

- All models are IP65 and DPDT.
- In place of ⊕, specify Key Retention Code. See table on right.
- Available as assembled units only.
- For accessories, see page 466.
- For dimensions, see page 468.

Switches & Pilot Lights

Display Lights

Relays & Sockets

Timers

Terminal Blocks

Circuit Breakers

Switch Engraving Order Form – A6 Series

Copy this order form and use it to specify Letter Height, Maximum Number of Lines and Text to be engraved.

To insure engraving accuracy, fax it to your IDEC representative or Distributor.

Your Company: _____
 Name: _____
 Address: _____
 PO: _____

Telephone: _____
 Fax: _____
 Email: _____
 Part Number to be Engraved: _____

Please check one of the boxes below to indicate your choice of engraving options:

Rectangular Switch

| | # of Lines | Letter Height | Max. Characters Per Line |
|--------------------------|------------|---------------|--------------------------|
| <input type="checkbox"/> | 1 | 5/32 | 6 |
| <input type="checkbox"/> | 2 | 5/32 | 6 |
| <input type="checkbox"/> | | 1/8 | 6 |
| <input type="checkbox"/> | 3 | 1/8 | 6 |
| <input type="checkbox"/> | 4 | N/A | |

Square Switch

| | # of Lines | Letter Height | Max. Characters Per Line |
|--------------------------|------------|---------------|--------------------------|
| <input type="checkbox"/> | 1 | 5/32 | 5 |
| <input type="checkbox"/> | 2 | 5/32 | 5 |
| <input type="checkbox"/> | | 1/8 | 6 |
| <input type="checkbox"/> | 3 | 1/8 | 6 |
| <input type="checkbox"/> | 4 | N/A | |

Round Switch

| | # of Lines | Letter Height | Max. Characters Per Line |
|--------------------------|------------|---------------|--------------------------|
| <input type="checkbox"/> | 1 | 5/32 | 3 |
| <input type="checkbox"/> | | 1/8 | 3 |
| <input type="checkbox"/> | 2 | 5/32 | Custom* |
| <input type="checkbox"/> | 3 | 1/8 | Custom* |
| <input type="checkbox"/> | 4 | 3/32 | Custom* |

*Engraving is possible, but character size will be smaller than standard sizes.



1. Engraving is done on the button itself for non-Illuminated pushbuttons and on marking plate for illuminated pushbuttons and pilot lights.
2. Please enter text exactly how you want it engraved, take care to emphasize capital or small letters.

Enter text to be engraved:

Line 1: _____
 Line 2: _____
 Line 3: _____
 Line 4: _____

Sample Letter Sizes

1/8 Letters: **OPEN**

5/32 Letters: **OPEN**

For IDEC Internal Use Only:
 Work Order #: _____

Accessories
Switches & Pilot Lights
Display Lights
Relays & Sockets
Timers
Terminal Blocks
Circuit Breakers

| Appearance | | Description | Used With | Part Number |
|-------------------------------|--|--|---|--------------|
| Locking Ring Wrench | | Made of metal. Used for tightening plastic locking ring during installation. Tightening torque should not exceed 3kgf-cm | Ø 5/8" (16mm) units | MT-001 |
| | | | Ø 31/64" (12mm) AP2M units | MT-002 |
| | | | Ø 13/32" (10mm) AP1M units | MT-003 |
| Lens Removal Tool | | Made of metal. Used for removing lens or button from the housing | All pushbuttons and pilot lights | MT-101 |
| Lamp Holder Tool | | Made of rubber. Used for removing and replacing LED lamps in illuminated units | All illuminated pushbuttons and pilot lights | OR-77 |
| Switch Guard | | Prevents inadvertent switch operation. IP40 dust-tight. 90 degrees opening maintained | Round/Square | AL-K6 |
| | | | Rectangular | AL-KH6 |
| | | | Prevents inadvertent switch operation. IP65 oiltight 180 degrees opening, spring return | Round/Square |
| | | | Rectangular | AL-KH6SP |
| Terminal Cover | | Made of translucent nylon. Fits over and shields the terminals | All 5/8" (16mm) units | AL-V6 |
| Dust Cover | | Fits over the lens or button to provide extra protection from dust (not applicable for oversize lenses or buttons). | All round units | AL-D6 |
| | | | All square units | AL-DQ6 |
| | | | All rectangular units | AL-DH6 |
| Adaptor Socket | | Plug-on terminal adaptor with solder terminals | | AL-C6 |
| | | Plug-on terminal adaptor with PCB terminals | All 5/8" (16mm) units | AL-C6V |
| Mounting Hole Plug | | Fills unused panel cutouts. Made of nitrile rubber. Push-in installation from front of panel. IP65 (oiltight). | Rubber | AL-B6 |
| | | Fills unused panel cutouts. Made of aluminum. Screw-on locking ring from inside of panel. IP65 (oiltight). | Aluminum | AL-BM6 |
| | | Round Mounting Hole Plug | Plastic (Applicable for flush mount switches only) | LA9Z-BS6 |
| | | Square Mounting Hole Plug | | LA9Z-BS7 |
| | | Rectangular Mounting Hole Plug | | LA9Z-BS8 |
| Replacement LED Lamps | | LED with built in current limiting resistor (with all illuminated assemblies). | 5V DC | LATD-5 ☉ |
| | | | 6V AC/DC | LATD-6 ☉ |
| | | | 12V AC/DC | LATD-1 ☉ |
| | | | 24V AC/DC | LATD-2 ☉ |
| Replacement Locking Ring | | Fastens operators to panel (included with all operators). | All switches & pilot lights | HA9Z-LN |
| Anti-Rotation Ring | | Prevents rotation of switches in panel (included with all operators). | All switches & pilot lights | AL6-LP |
| Replacement Engraving Inserts | | Engraving plates to allow legends underneath translucent lenses (included with all lenses). | Round standard | AL6M-W |
| | | | Square standard | AL6Q-W |
| | | | Rectangular standard | AL6H-W |
| | | | Round oversize | AL6M-MW |
| | | | Square/rectangular oversize | AL6Q-QW |
| Replacement Keys | | Pair of keys (#132). All key switches use same standard key. | All key selectors | AS6-SK |

1. In place of ☉ specify color code. A=Amber, G=Green, Y=Yellow, R=Red, S=Blue, W=Warm White, JW=Cool White.
 2. LEDs include built-in current limiting resistor and reverse polarity protection diode.

| Appearance | Description | Used With | Part Number |
|---|--|--|-------------|
| Flush Bezel | ø24mm round, metal (aluminum color), panel cut-out ø20.2mm | Pushbuttons, pilot lights, illuminated pushbutton, selector switches, key selector switches and illuminated selector switches. A6 Switch + Flush Bezel = Flush Switch | LA9Z-SM61 |
| | ø24mm round, plastic (black), square panel cut-out ø20.2mm | | LA9Z-S61B |
| | 24mm square, plastic (black), panel cut-out 20.2 x 20.2mm | | LA9Z-S71B |
| | 24 x 30mm rectangular, plastic (black), rectangular panel cut-out ø20.2 x 26.2mm | | LA9Z-S81B |
| Switch Guard w/ Flush Bezel (spring return) | Rectangular, plastic (black) | | LA9Z-KS8 |

Schematics — A Series: 5/8" (16mm)

Terminal Arrangement (Top View)

Illuminated Pushbuttons

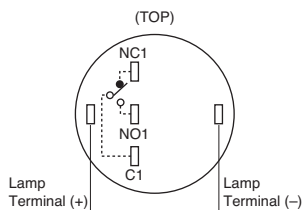

SPDT Contact (Single-pole/Double Throw)

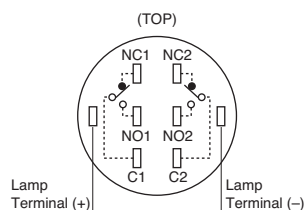

DPDT Contact (Double-pole/Double Throw)

Non-illuminated Pushbuttons and Selector Switches

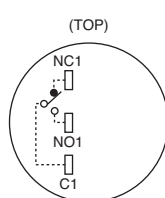

SPDT Contact (Single-pole/Double Throw)

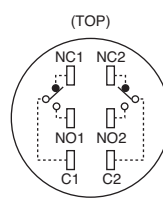

DPDT Contact (Double-pole/Double Throw)

Pilot Lights

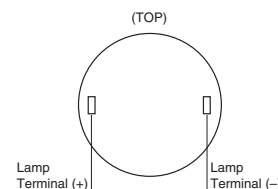

IDEC's Superbright LED Internal Circuits

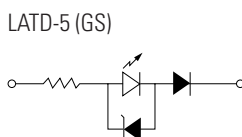
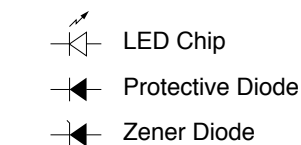
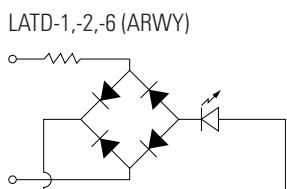
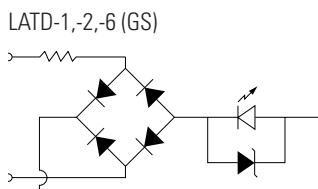

Switches & Pilot Lights

Display Lights

Relays & Sockets

Timers

Terminal Blocks

Circuit Breakers

Dimensions (mm)

Pushbuttons, Ø 5/8" (16mm)

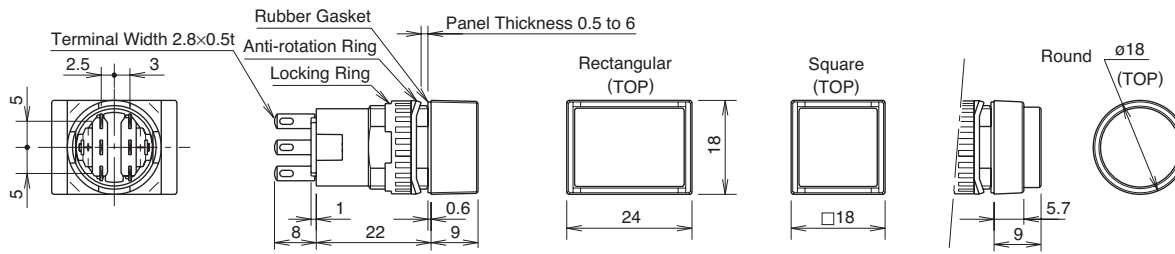

Oversize Lens

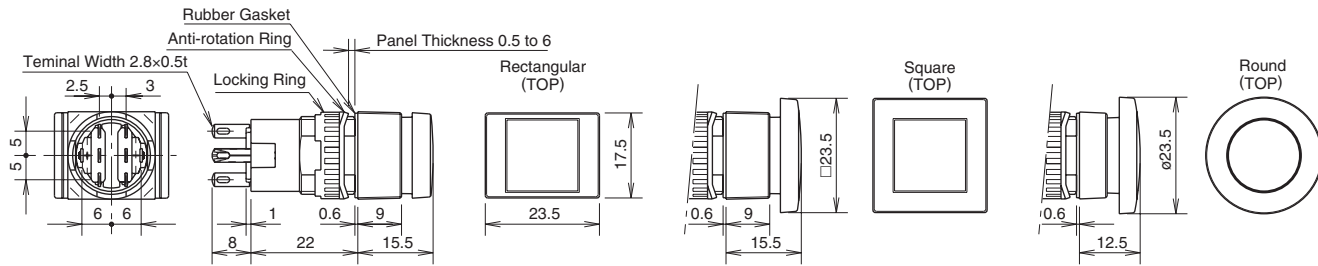

Selector Switches, Ø 5/8" (16mm)

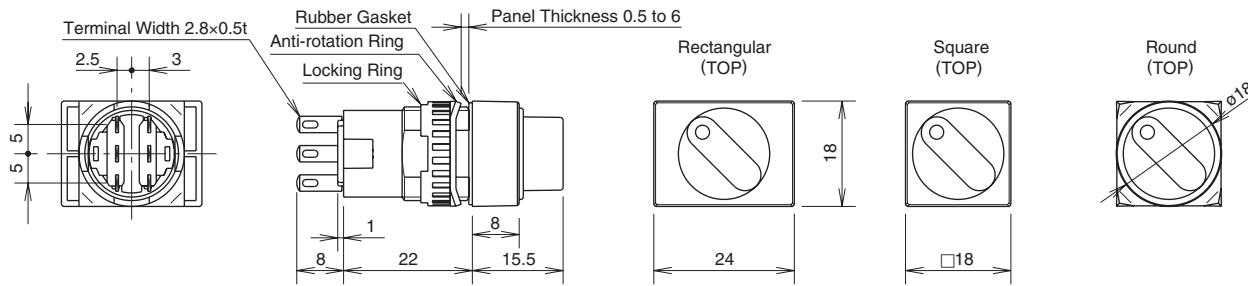

Key Selector Switches, Ø 5/8" (16mm)

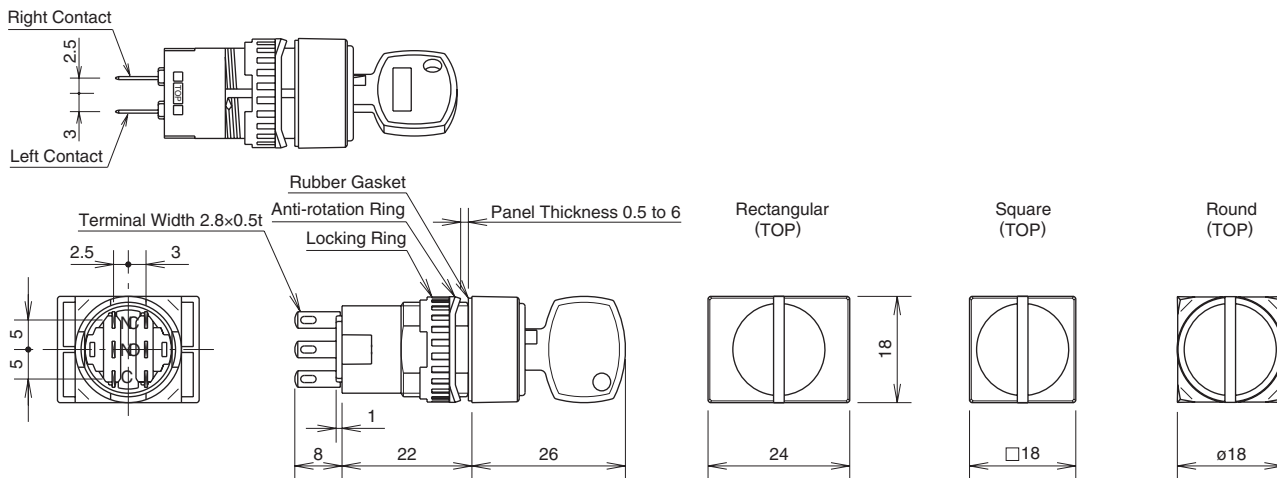

Switches & Pilot Lights

Display Lights

Relays & Sockets

Timers

Terminal Blocks

Circuit Breakers

Switch Guard, Ø 5/8" (16mm)

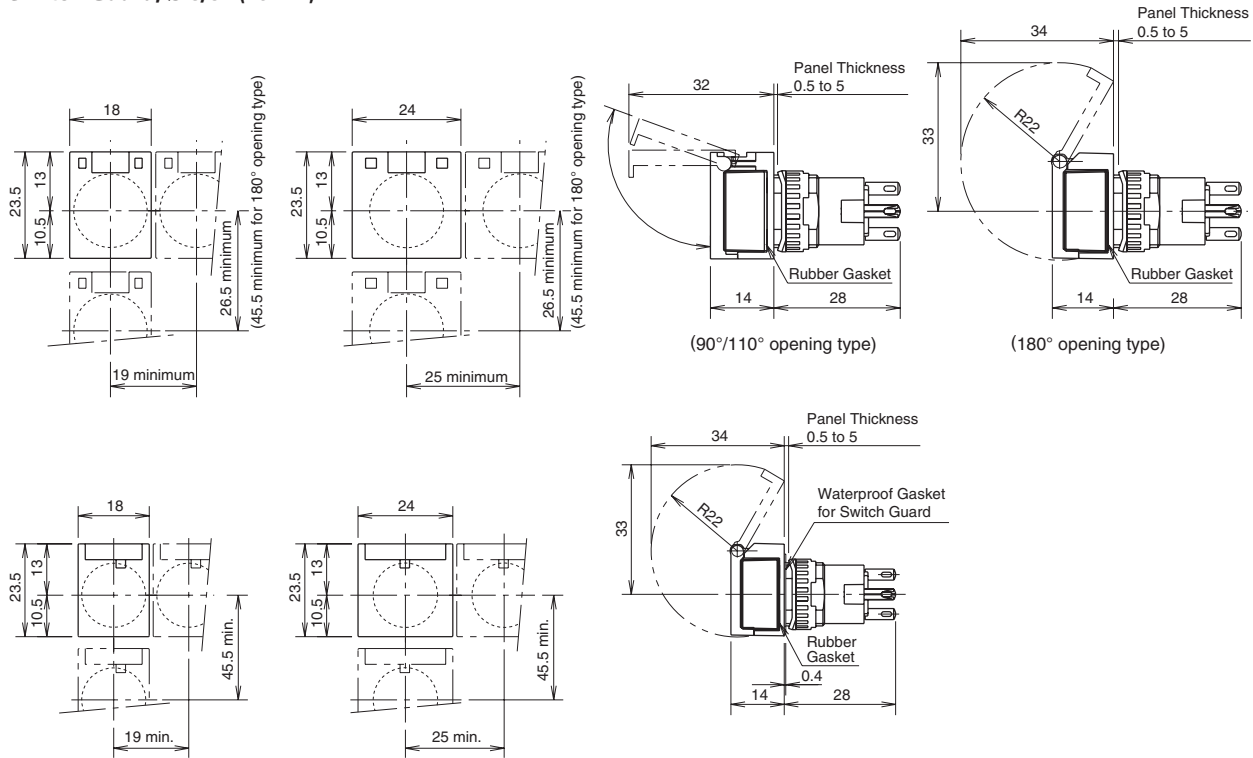

Flush Bezel

Flush Bezel with Switch

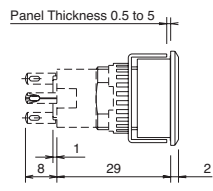
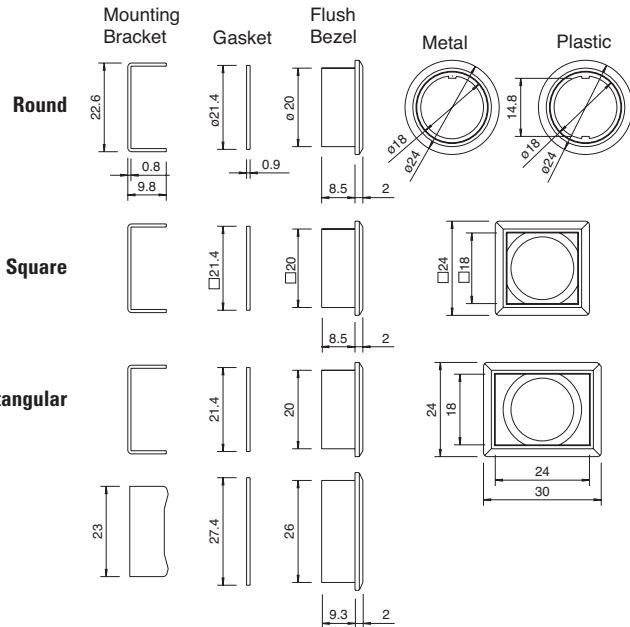

Selector Switches

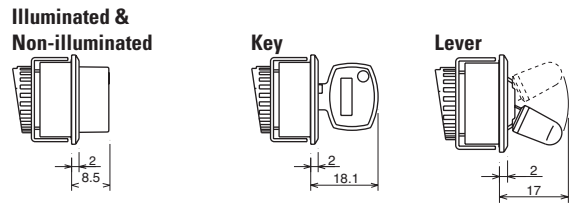

Flush Bezel Mounting Hole Layout

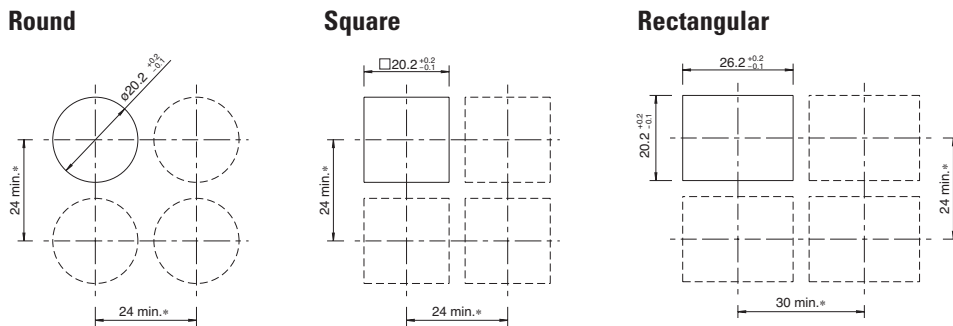

Switches & Pilot Lights

Display Lights

Relays & Sockets

Timers

Terminal Blocks

Circuit Breakers

Terminal Sockets

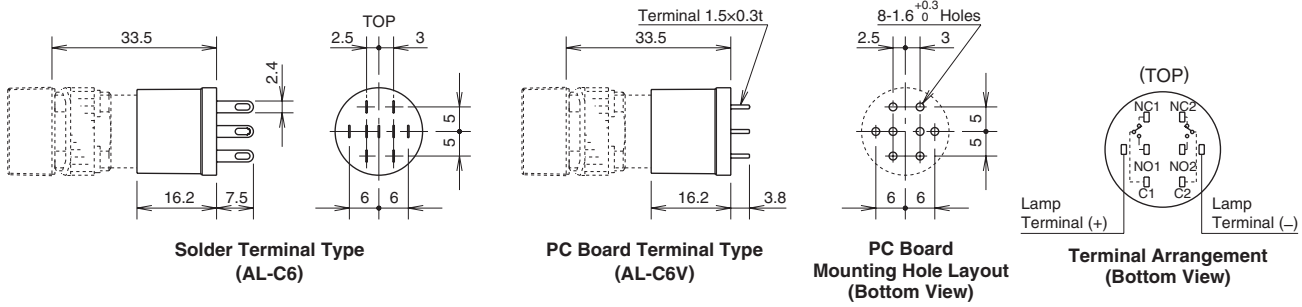

Dust Covers

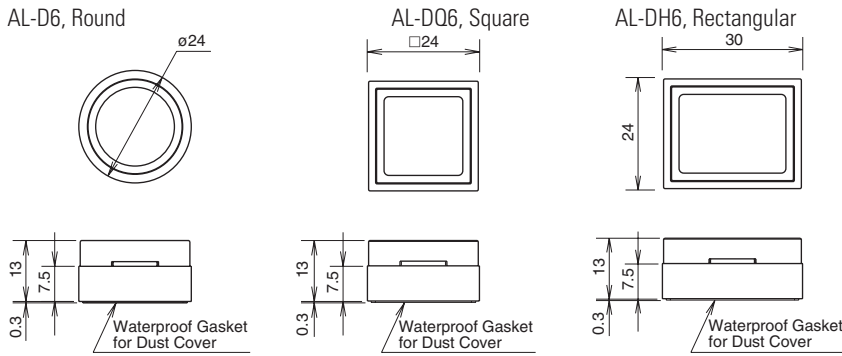

Panel Cut-Outs For Units w/Dust Cover

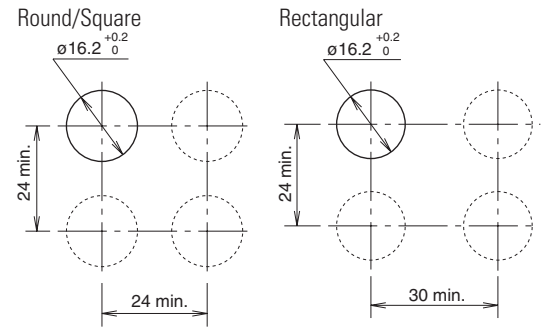

Marking Plates

Pushbuttons with Standard Size Lens

| Style | Round—AL6M-W | Square—AL6Q-W | Rectangular—AL6H-W |
|------------------|--------------------|---------------|--|
| Dimensions | | | |
| | $\phi 5/8"$ (16mm) | | |
| Outside (OD) | (13.8mm) | (13.8mm) | (OD ¹ x OD ²) 13.8 x 19.8mm |
| Marking Area (a) | (12mm) | (12mm) | (a ¹ x a ²) 12 x 18mm |

Pushbuttons with Oversize Lens

| Style | Round—AL6M-MW | Square/Rectangular—AL6Q-QW |
|------------------|------------------------|----------------------------|
| Dimensions | | |
| Outside (OD) | $\phi 0.491"$ (12.6mm) | 0.491" (12.6mm) |
| Marking Area (a) | $\phi 0.429"$ (11mm) | 0.429" (11mm) |

Engraving must be made on the engraving area within 0.02" (0.5mm) deep.

Replacing & and Marking Plate

Removal

Remove the lens holder assembly (lens, marking plate and holder) from the operator by holding the color lens recesses with the lens removal tool (Part No.MT-101) and pulling out. Remove marking plate by pushing the color lens from the rear to disengage the latches. Marking plate must be engraved on the side as shown in the figure on the right.
 $\phi 5/8"$ (16mm)

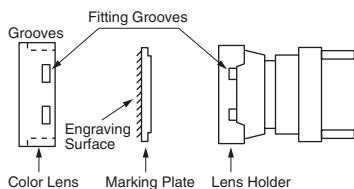

Installation

For illuminated pushbuttons:

1. Insert marking plate inside lens in correct direction
2. Press color lens on to lens holder to engage latches.
3. Insert lens holder into housing in correct direction.

Do not loosen spring on illuminated pushbutton units (except on pilot light units). The marking plate must be engraved on the front side as shown above.

X-ON Electronics

Largest Supplier of Electrical and Electronic Components

Click to view similar products for [Piezo Buzzers & Audio Indicators](#) category:

Click to view products by [Idec](#) manufacturer:

Other Similar products are found below :

[PFD-21A29W](#) [PLD-21N30W](#) [REM-6027F-1.5](#) [RH1020C-010-NFP-G-NL](#) [PFD-27N36W](#) [KBS-20DA-7AS](#) [KBS-27DA-5C-105](#)
[RFS5015382PNL](#) [MSR516NP](#) [DMT-1606S-NL](#) [OMT112](#) [SCE016SD3CM4B](#) [DMT-09-1-4B-NL](#) [HBO0302C-58/1248](#) [AT-3045-TF-LW110-](#)
[R](#) [SMA-17-S](#) [BMS3650L-LF](#) [SMT-0540-T-7-R](#) [SMT-0540-T-2-R](#) [AT-0927-TT-2-R](#) [AT-2310-T-LW100-R](#) [SMI-1324-TW-5V-4-R-T/R](#)
[SMI-1324-TW-5V-2-R-T/R](#) [SC0715BL](#) [AI-1027-TWT-5V-R](#) [SC235AF](#) [SMT-0827-TW-5V-R](#) [AT-2830-TWT-R](#) [AT-1220-TT-5-R](#) [AT-](#)
[1220-TT-10-R](#) [AT-1127-ST-2-R](#) [AT-1220-TWT-5V-R](#) [AT-1750-TFL-LW95-R](#) [SMT-1427-S-R](#) [SMT-1127-S-R](#) [AI-3245-TF-LW95-R](#) [AI-](#)
[2438-TT-R](#) [AB2040B](#) [SMT-1324-TW-5V-R](#) [AT-2429-TWT-R](#) [AI-1223-TWT-12V-3-R](#) [AI-1440-TWT-24V-2-R](#) [AB4113B](#) [AI-2304-TF-](#)
[LW120-12V-R](#) [AI-4329-P-SP28-R](#) [XL-5020-TF-LW150-S-R](#) [SMA-30-P17.5](#) [AI-5025-TWT-R](#) [X-5735-LW350-S-2-R](#) [AW-10PR](#)