

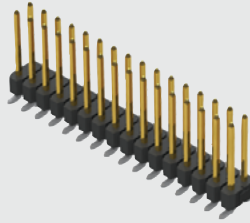

(2.54 mm) .100"

TSM-116-02-S-DV-LC



TSM-121-01-T-SV

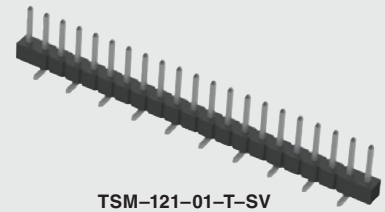

# SMT .025" SQ POST HEADER

**Board Mates:**

SSW, SSQ, SSM, BSW, ESW, ESQ, BCS, SLW, CES, HLE

**Cable Mates:**

IDSS, IDSD

**SPECIFICATIONS**

For complete specifications and recommended PCB layouts see [www.samtec.com?TSM](http://www.samtec.com?TSM)

**Insulator Material:**

Black Liquid Crystal Polymer

**Terminal Material:**

Phosphor Bronze

**Plating:**

Au or Sn over 50 μm (1.27 μm) Ni

**Operating Temp Range:**

-55 °C to +105 °C with Tin;

-55 °C to +125 °C with Gold

**Voltage Rating:**

475 VAC -SV/-DV mated with BCS or SSM

RoHS Compliant: Yes

MATES	CURRENT RATING (PER PIN)
TSM/SSW	4.7 A
TSM/SSM	5.4 A
TSM/HLE	4.1 A
<b>2 PINS POWERED</b>	

**PROCESSING**

**Lead-Free Solderable: Yes**

**-DH/-SH Lead Coplanarity:** (0.15 mm) .006" max (02-36)\*

**-DV/-SV Lead Coplanarity:** (0.10 mm) .004" max (02-05)

(0.13 mm) .005" max (06-10)\*

(0.15 mm) .006" max (11-36)\*

\*(.004" stencil solution may be available; contact [IPG@samtec.com](mailto:IPG@samtec.com))

**RECOGNITIONS**

For complete scope of recognitions see [www.samtec.com/quality](http://www.samtec.com/quality)



**ALSO AVAILABLE (MOQ Required)**

- Edge Mount and Locking Clips for -SV
- Solder Locks for -DH and Shrouds for -DV
- Other platings

**Note:** Some lengths, styles and options are non-standard, non-returnable.

<b>TSM</b>	<b>1</b>	<b>NO. PINS PER ROW</b>	<b>LEAD STYLE</b>	<b>PLATING OPTION</b>	<b>ROW OPTION</b>
		<b>02 thru 36</b>		<b>-F</b> = Gold flash on post, Matte Tin on tail	
				<b>-L</b> = 10 μm (0.25 μm) Gold on post, Matte Tin on tail	
				<b>-S</b> = 30 μm (0.76 μm) Gold on post, Matte Tin on tail	
				<b>-T</b> = Matte Tin	

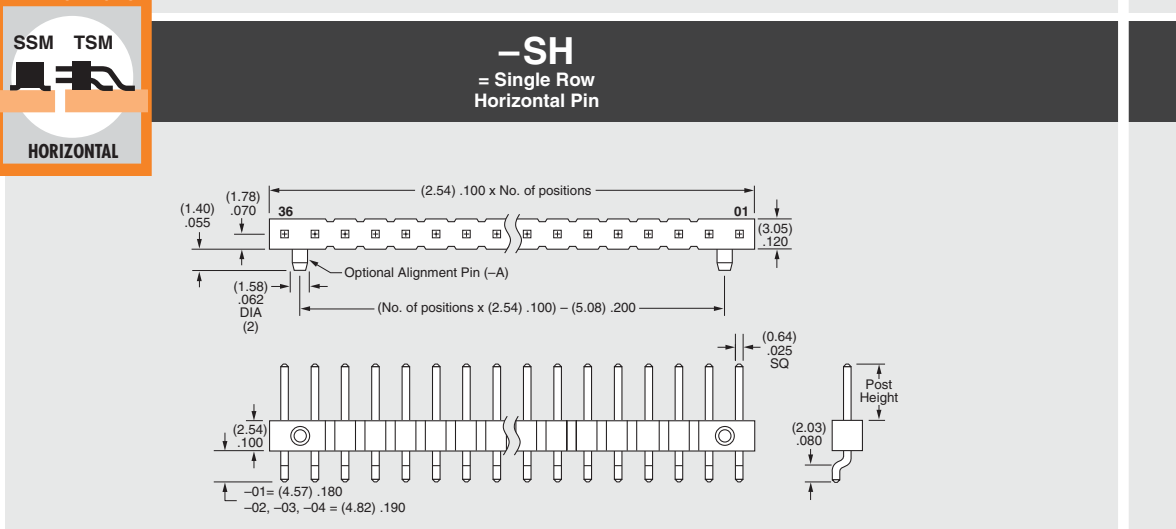
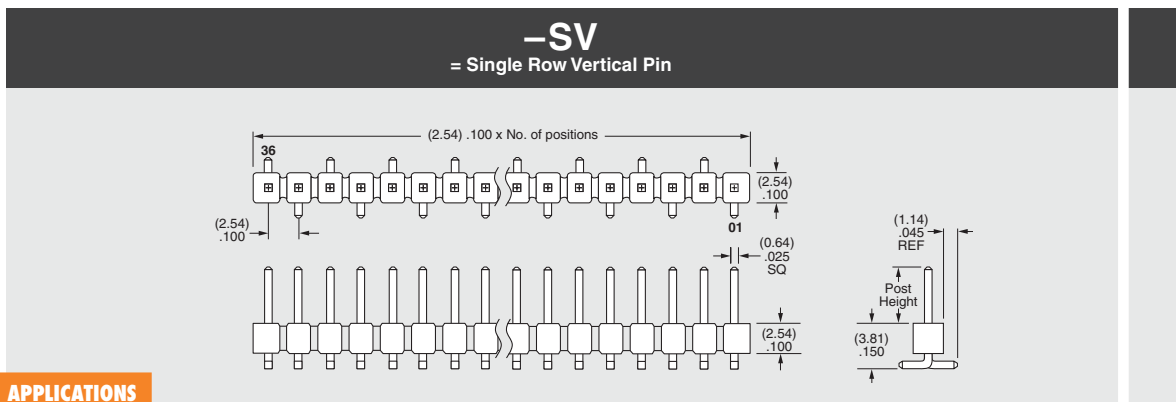
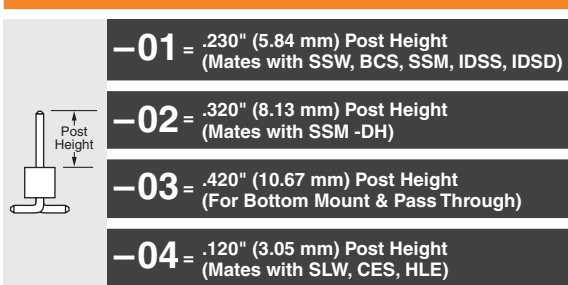

Due to technical progress, all designs, specifications and components are subject to change without notice.

[WWW.SAMTEC.COM](http://WWW.SAMTEC.COM)

All parts within this catalog are built to Samtec's specifications. Customer specific requirements must be approved by Samtec and identified in a Samtec customer-specific drawing to apply.

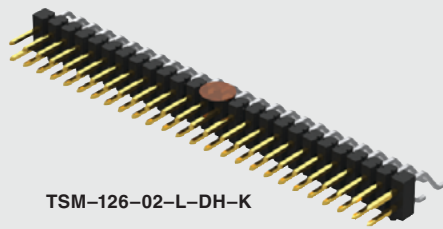

TSM-126-02-L-DH-K

TSM-115-01-T-SH-A

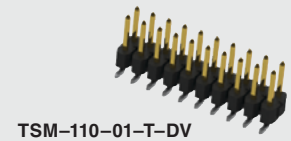
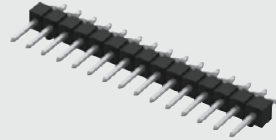

TSM-110-01-T-DV

**TSM SERIES**

**OTHER OPTIONS**

**-A**

= Alignment Pin metal or plastic at Samtec discretion (Not available with -TM or -MT) (02 positions min.) (Not available with -LC)

**-LC**

= Locking Clip (Not available with -TM) (3 positions min.) (Not available with -A) (Manual placement required)

**-K**

= (6.50 mm) .256" DIA Polyimide Film Pick & Place Pad (-SH: 4 positions minimum without -TR; 2 & 3 positions available with -TR) (-DH: 4 positions minimum without -TR)

**-“XXX”**

= Polarized Position

**-P**

= Plastic Pick & Place Pad (-DV: 4 positions minimum without -TR; 2 & 3 positions available with -TR) (-SH: 4 positions minimum without -TR; 2 & 3 positions available with -TR) (-DH: 5 positions minimum without -TR) (-SV: 4 positions minimum without -TR; 2 & 3 positions available with -TR)

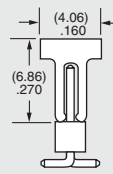

**-SV**

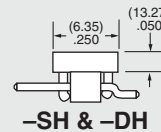

**-SH & -DH**

**-TR**

= Tape & Reel Packaging -SV = 02-22 positions -DV = 02-28 positions -SH = 02-30 positions -DH = 02-29 positions

Not available with -MT or -TM

**-DV**

= Double Row Vertical Pin

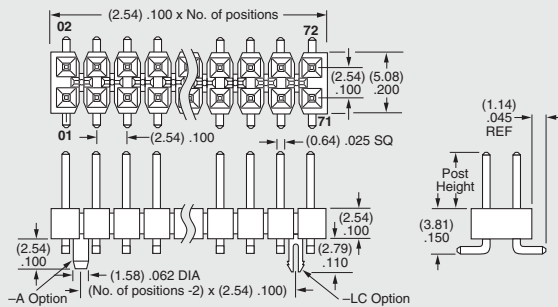

**-TM**

= Triple Row Vertical Mixed Technology (Style -01 only)

02 thru 30 positions only

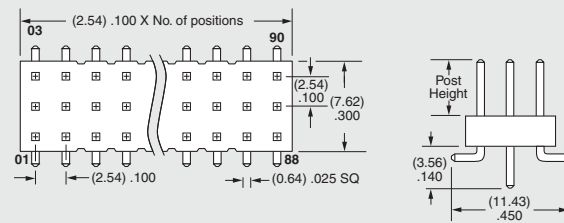

**-DH**

= Double Row Horizontal Pin (Style -01, -02 or -03 only)

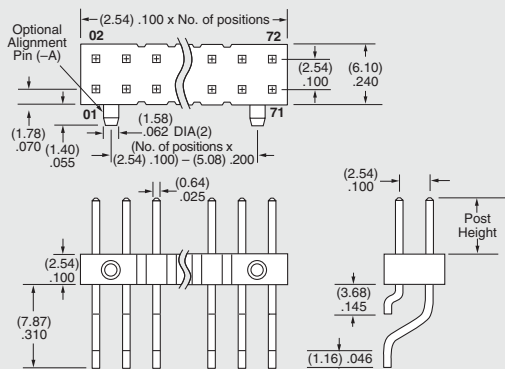

**-MT**

= Mixed Technology Pin (Style -01, -02 or -03 only)

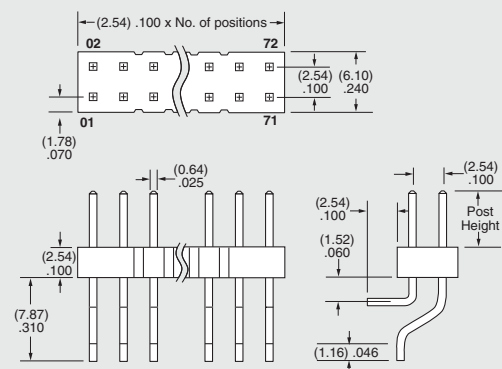

Due to technical progress, all designs, specifications and components are subject to change without notice.

[WWW.SAMTEC.COM](http://WWW.SAMTEC.COM)

All parts within this catalog are built to Samtec's specifications. Customer specific requirements must be approved by Samtec and identified in a Samtec customer-specific drawing to apply.

## X-ON Electronics

Largest Supplier of Electrical and Electronic Components

*Click to view similar products for [Headers & Wire Housings](#) category:*

*Click to view products by [Samtec](#) manufacturer:*

Other Similar products are found below :

[95000-104TRLF](#) [10135584-644402LF](#) [DF62W-EP2022PCA](#) [95000-106TRLF](#) [DF62W-2022SCA](#) [DF62W-EP2022PC](#) [2203348](#) [DF62W-2022SC](#) [1084018](#) [1029039](#) [1084017](#) [802-10-012-10-002000](#) [1112640](#) [1112639](#) [000-34000](#) [0009482033](#) [0009507031](#) [57102-S06-03LF](#) [57202-S52-04LF](#) [PCN6-15S-2.5E](#) [0039019024](#) [58102-G61-06LF](#) [582553-1](#) [0009485154](#) [0009508121](#) [0022285053](#) [0050291907](#) [018731A](#) [LY20-4P-DT1-P1E-BR](#) [02.125.8002.8](#) [60101931](#) [60598-1 \(Cut Strip\)](#) [M1625-3R/100](#) [61062-3](#) [61082-181009](#) [636-1427](#) [638009-1](#) [641938-9](#) [641991-4](#) [644168-1](#) [647662-1](#) [65039-019ELF](#) [65817-002LF](#) [65817-015LF](#) [65863-015LF](#) [66207-023LF](#) [67016-026LF](#) [67046-001LF](#) [67095-007LF](#) [67230-005LF](#)