

Series AM1D-NZ

1 Watt | DC-DC Converter



FEATURES:

- RoHS compliant
- 7 pin SIP package
- High efficiency up to 82%
- Low profile plastic package
- Operating temperature -40°C to + 85°C or -40°C to + 105°C on 6000V models
- 1 sec short circuit protection or continuous on 6000V models
- Pin compatible with multiple manufacturers

Models Single output



Model	Input Voltage (V)	Output Voltage (V)	Output Current max (Ma)	Input Current Max No Load (mA)	Isolation (VDC)	Efficiency (%)
AM1D-0505S-NZ	4.5-5.5	5	200	250 20	1000	72
AM1D-0512S-NZ	4.5-5.5	12	83	250 20	1000	77
*AM1D-0515S-NZ	4.5-5.5	15	70	248 20	1000	79
*AM1D-1205S-NZ	10.8-13.2	5	200	92 15	1000	73
AM1D-0505SH30-NZ	4.5-5.5	5	200	250 20	3000	70
AM1D-0509SH30-NZ	4.5-5.5	9	110	250 20	3000	75
*AM1D-0515SH30-NZ	4.5-5.5	15	70	248 20	3000	80
AM1D-1205SH30-NZ	10.8-13.2	5	200	92 15	3000	72
AM1D-2415SH30-NZ	21.6-26.4	15	70	52 7	3000	82
AM1D-0505SH60-NZ	4.5-5.5	5	200	256 30	6000	75
AM1D-0509SH60-NZ	4.5-5.5	9	110	253 30	6000	75
AM1D-0515SH60-NZ	4.5-5.5	15	70	253 30	6000	78
AM1D-1205SH60-NZ	10.8-13.2	5	200	104 20	6000	78
AM1D-1209SH60-NZ	10.8-13.2	9	110	104 20	6000	76
AM1D-1212SH60-NZ	10.8-13.2	12	83	104 20	6000	79
AM1D-1215SH60-NZ	10.8-13.2	15	70	104 20	6000	81

Models Dual output

Model	Input Voltage (V)	Output Voltage (V)	Output Current (mA)	Input Current Max No Load (mA)	Isolation (VDC)	Efficiency (%)
AM1D-0505D-NZ	4.5-5.5	±5	±100	250 20	1000	72
AM1D-0509D-NZ	4.5-5.5	±9	±55	250 20	1000	75
AM1D-0512D-NZ	4.5-5.5	±12	±42	250 20	1000	78
AM1D-0515D-NZ	4.5-5.5	±15	±35	248 20	1000	79
AM1D-1212D-NZ	10.8-13.2	±12	±42	92 15	1000	79
AM1D-2412D-NZ	21.6-26.4	±12	±42	51 7	1000	80
AM1D-0505DH30-NZ	4.5-5.5	±5	±100	250 20	3000	72
AM1D-0512DH30-NZ	4.5-5.5	±12	±42	250 20	3000	78
AM1D-1212DH30-NZ	10.8-13.2	±12	±42	92 15	3000	79
*AM1D-1215DH30-NZ	10.8-13.2	±15	±35	90 15	3000	80
AM1D-2405DH30-NZ	21.6-26.4	±5	±100	56 7	3000	74
AM1D-2415DH30-NZ	21.6-26.4	±15	±35	52 7	3000	81
AM1D-0505DH60-NZ	4.5-5.5	±5	±100	256 30	6000	75
AM1D-0509DH60-NZ	4.5-5.5	±9	±55	253 30	6000	75
AM1D-0512DH60-NZ	4.5-5.5	±12	±42	253 30	6000	78
AM1D-0515DH60-NZ	4.5-5.5	±15	±35	253 30	6000	78

Models

Dual output (continued)

Model	Input Voltage (V)	Output Voltage (V)	Output Current (mA)	Input Current Max No Load (mA)	Isolation (VDC)	Efficiency (%)
AM1D-1205DH60-NZ	10.8-13.2	±5	±100	104 20	6000	78
AM1D-1209DH60-NZ	10.8-13.2	±9	±55	102 20	6000	79
AM1D-1212DH60-NZ	10.8-13.2	±12	±42	103 20	6000	81
AM1D-1215DH60-NZ	10.8-13.2	±15	±35	102 20	6000	81

*Not recommended for new design

Input Specifications

Parameters	Nominal	Typical	Maximum	Units
Voltage range	5	4.5-5.5		VDC
	12	10.8-13.2		
	24	21.6-26.4		
Filter	Capacitor			

Isolation Specifications

Parameters	Conditions	Typical	Rated	Units
Tested I/O voltage	60 sec		1000, 3000 & 6000	VDC
Resistance		> 1000		MOhm
Capacitance		60		pF

Output Specifications

Parameters	Conditions	Typical	Maximum	Units
Voltage accuracy		±5		%
Voltage balance	Dual Output	±1		%
Short Circuit protection		Momentary (1 sec.) Continuous on 6000V models		
Line voltage regulation (Single)	For 1.0% of Vin	±1.2		%
Line voltage regulation (Dual)	For 1.0% of Vin	±1.2		%
Load voltage regulation (Single)	load 10~100%	10		%
Load voltage regulation (Dual)	load 10~100%	10		%
Temperature coefficient		±0.03		%/°C
Ripple & Noise	At 20MHz Bandwidth	75		mV p-p

General Specifications

Parameters	Conditions	Typical	Maximum	Units
Switching frequency	100% load (6000V models only)	150 40		KHz
Max Case temperature			+125	°C
Operating temperature		-40 to +85 Up to +105 on 6000V models only, see derating table		°C
Storage temperature		-55 to +125		°C
Derating		Not-Required		
Cooling		Free air convection		
Humidity			90	%
Case material		Non-conductive black plasticUL94V-0		
Weight		2		g
Dimensions (L x W x H)	1000 & 3000VDC	0.76 x 0.24 x 0.37 inch		19.5 x 6.00 x 9.35 mm
	6000VDC	0.76 x 0.39 x 0.49 inch		19.50 x 9.80 x 12.5 mm
MTBF		>1 100 000 hrs (MIL-HDBK -217F, Ground Benign, t=+25°C)		

NOTE: All specifications in this datasheet are measured at an ambient temperature of 25°C, humidity<75%, nominal input voltage and at rated output load unless otherwise specified

Safety Specifications

Parameters	
Standards	UL60950-1: 2001
Agency approvals	cULus (without 6000VDC Isolated dual output models);
	CE (for 3000VDC Isolation models and single 1000VDC Isolation models)
	NOTE: all other models not referenced above are designed to meet standard IEC 60950-1:2001

Pin Out Specifications

Pin	1000 VDC		3000, 6000 VDC	
	Single	Dual	Single	Dual
1	+ V Input	+ V Input	+ V Input	+ V Input
2	- V Input	- V Input	- V Input	- V Input
4	- V Output	- V Output	No pin	No pin
5	No pin	Common	- V Output	- V Output
6	+ V Output	+ V Output	No pin	Common
7	No pin	No pin	+ V Output	+ V Output

Recommended Circuit

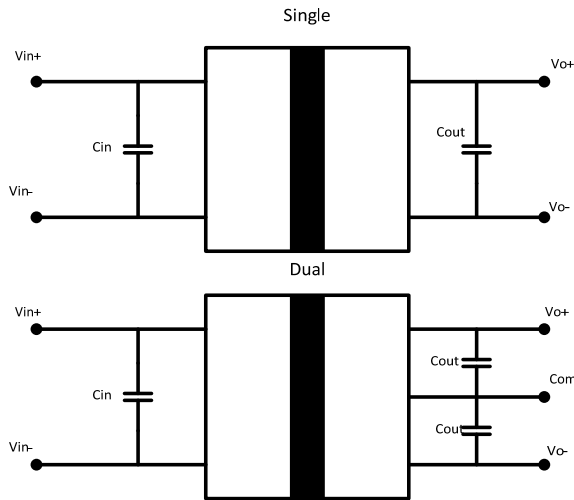

External capacitor – Single output

Vin (VDC)	External capacitor (μF)	Vout (VDC)	External capacitor (μF)
5	4.7	5	10
12	2.2	9	4.7
24	1	12	2.2
-	-	15	1

External capacitor – Dual output

Vin (VDC)	External capacitor (μF)	Vout (VDC)	External capacitor (μF)
5	4.7	5	10
12	2.2	9	4.7
24	1	12	2.2
-	-	15	1

Dimensions
1000 and 3000VDC

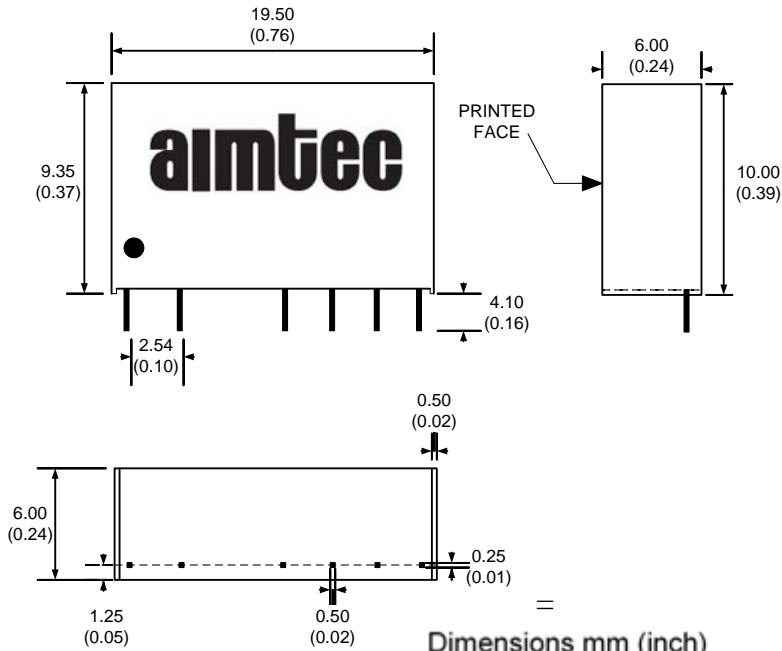

Dimensions
6000VDC

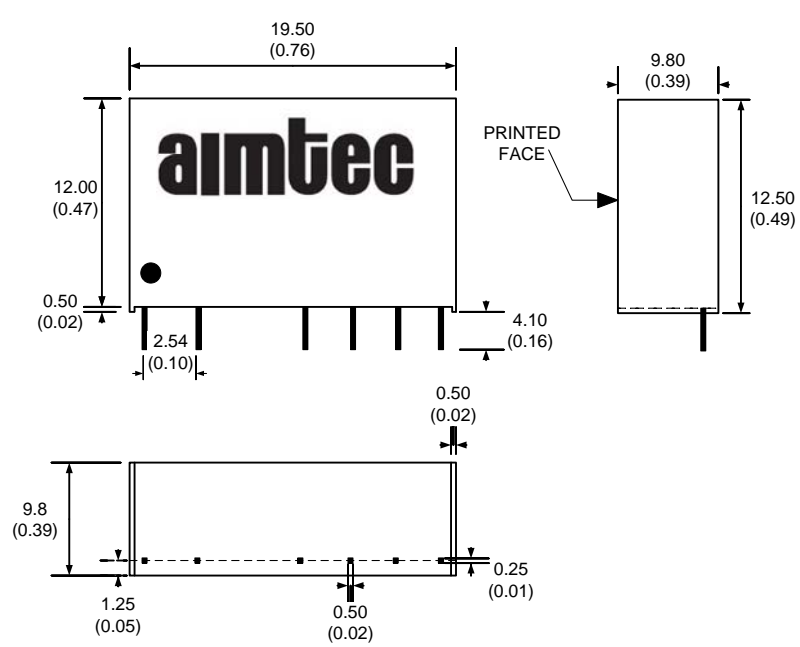

Dimensions mm (inch)
Case Tolerance ± 0.5 (± 0.02)
Pin Diameter $0.60 \Phi \pm 0.05$ (± 0.002)
Pin Pitch Tolerance ± 0.50 (± 0.02)

Input Reflected Ripple

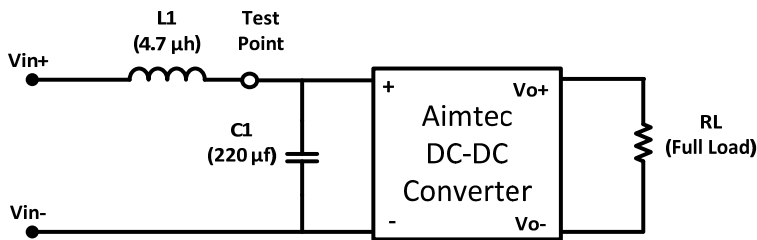

* Tested at full load, and nominal input

EMI Filter

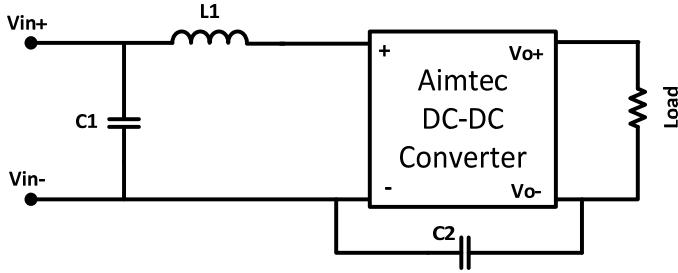

Vin	C1	L1	C2
5, 9, 12 Vdc	4.7 μ F / 50V	6.8 μ H	
15 Vdc	4.7 μ F / 50V	6.8 μ H	470 pF / 2kV

Regulation Graph

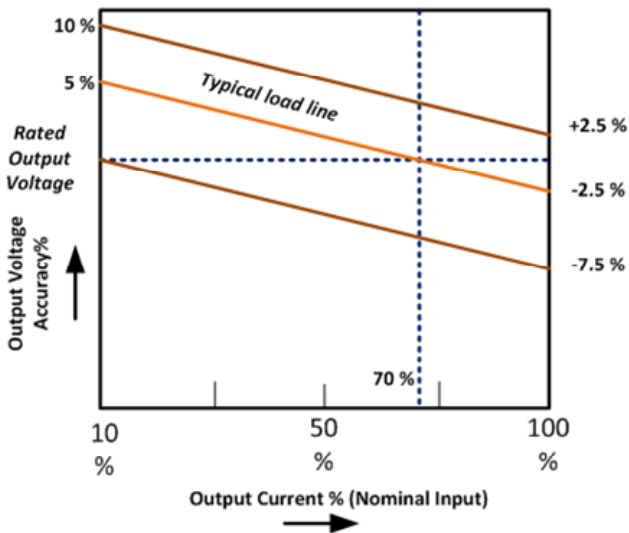

Derating Chart (6000V Isolation Models Only)

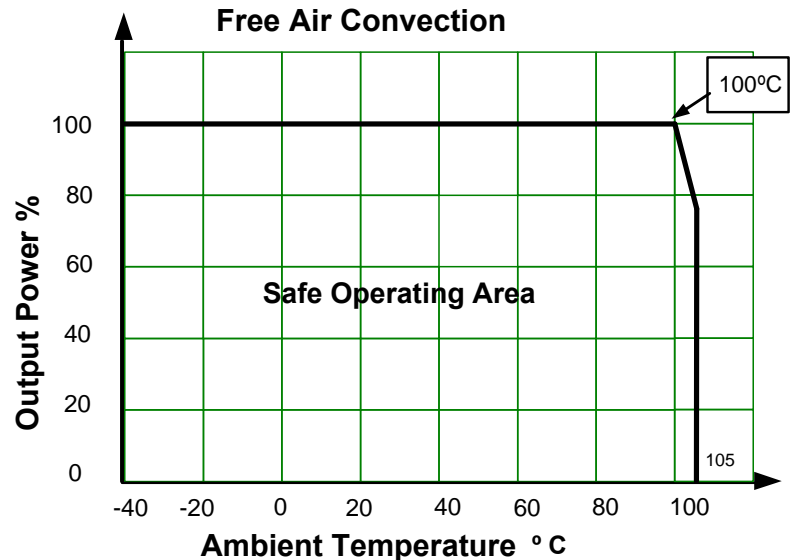

NOTE: 1. Datasheets are updated as needed and as such, specifications are subject to change without notice. Once printed or downloaded, datasheets are no longer controlled by Aimtec; refer to www.aimtec.com for the most current product specifications. 2. Product labels shown, including safety agency certifications on labels, may vary based on the date manufactured. 3. Mechanical drawings and specifications are for reference only. 4. All specifications are measured at an ambient temperature of 25°C, humidity < 75%, nominal input voltage and at rated output load unless otherwise specified. 5. Aimtec may not have conducted destructive testing or chemical analysis on all internal components and chemicals at the time of publishing this document. CAS numbers and other limited information are considered proprietary and may not be available for release. 6. This product is not designed for use in critical life support systems, equipment used in hazardous environments, nuclear control systems or other such applications which necessitate specific safety and regulatory standards other than the ones listed in this datasheet. 7. Warranty is in accordance with Aimtec's standard Terms of Sale available at www.aimtec.com.

X-ON Electronics

Largest Supplier of Electrical and Electronic Components

Click to view similar products for [Isolated DC/DC Converters](#) category:

Click to view products by [Aimtec](#) manufacturer:

Other Similar products are found below :

[ESM6D044440C05AAQ](#) [FMD15.24G](#) [PSL486-7LR](#) [PSR152.5-7IR](#) [Q48T30020-NBB0](#) [AVO240-48S12B-6L](#) [AVO250-48S28B-6L](#) [NAN-0505](#) [HW-L16D](#) [JAHW100Y1](#) [217-1617-001](#) [22827](#) [SPB05C-12](#) [SQ24S15033-PS0S](#) [18952](#) [19-130041](#) [CE-1003](#) [CE-1004](#) [GQ2541-7R](#) [PSE1000DCDC-12V](#) [RDS180245](#) [MAU228](#) [419-2065-201](#) [449-2075-101](#) [TME 0303S](#) [TME 0505S](#) [TME 1205S](#) [TME 1212S](#) [TME 2405S](#) [TME 2412S](#) [V300C24C150BG](#) [419-2062-200](#) [419-2063-401](#) [419-2067-101](#) [419-2067-501](#) [419-2068-001](#) [DCG40-5G](#) [DFC15U48D15](#) [449-2067-000](#) [XGS-0512](#) [XGS-1205](#) [XGS-1212](#) [XGS-2412](#) [XGS-2415](#) [XKS-1215](#) [033456](#) [NCT1000N040R050B](#) [SPB05B-15](#) [SPB05C-15](#) [TME 0509S](#)