

Surface  
**SMT**  
Mount

# .050" MICRO HEADER FTSH SERIES

## SPECIFICATIONS

For complete specifications and recommended PCB layouts see [www.samtec.com?FTSH](http://www.samtec.com?FTSH)

**Insulator Material:** Black Liquid Crystal Polymer  
**Terminal Material:** Phosphor Bronze  
**Plating:** Sn or Au over 50µ" (1,27µm) Ni  
**Current Rating:** 1.75A @ 80°C ambient  
**Operating Temp Range:** -55°C to +125°C

**Processing:**  
**Max Processing Temp:** 230°C for 60 seconds, or 260°C for 20 seconds 3x  
**Lead-Free Solderable:** Yes  
**SMT Lead Coplanarity:** (0,10mm) .004" max (02-25) (0,15mm) .006" max (26-50)

Mates with:  
FFSD, CLP, FLE, SFMC, SFMH

## APPLICATIONS



## ALSO AVAILABLE

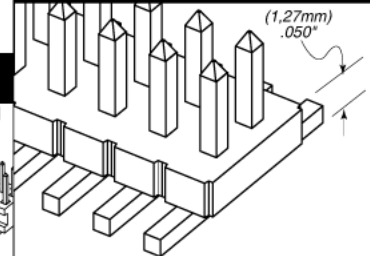

Ultra-low profile option available. End Shrouds available. Call for FTS Series specifications.

## OPTIONS

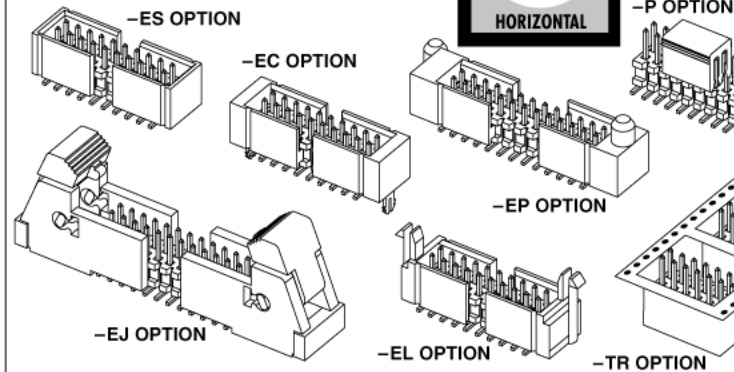

## APPLICATION SPECIFIC OPTION

Molded pick-and-place pads, latches, single row option and straddle mount leads available. Call Samtec.

FTSH

1

NO. PINS PER ROW

LEAD STYLE

02 thru 50

- 01 = (3,05) .120" Post (Mates with FFSD, FLE)
- 02 = (1,91) .075" Post (Mates with FLE)
- 03 = (1,65) .065" Post (Mates with CLP -D)
- 04 = (3,81) .150" Post (Mates with SFMC, SFMH)

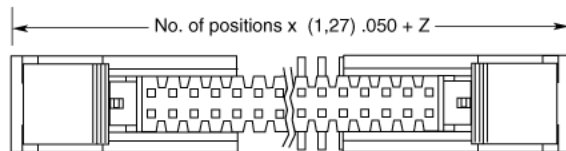
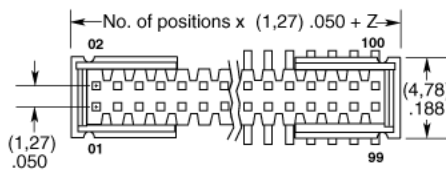

LEAD STYLE	A
-01	(3,05) .120
-02	(1,91) .075
-03	(1,65) .065
-04	(3,81) .150

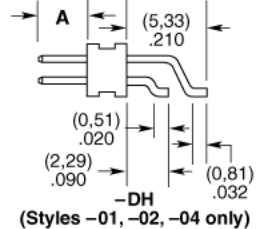

OPTION	Z
-ES	(2,57) .101
-EJ	(15,77) .621
-EC	(3,33) .131
-EP	(5,87) .231
-EL	(6,53) .257

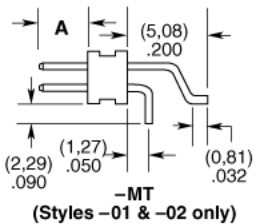
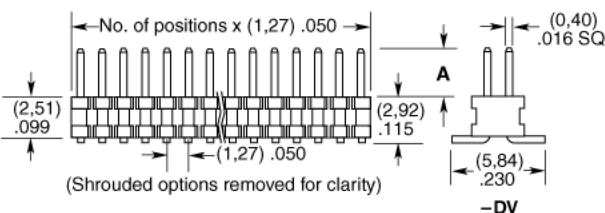

**TAPE & REEL AVAILABILITY**  
 No tooling charges. 125 piece minimum order. Order any quantity above minimum. In-house design, manufacture. Quick turn-around. Call Samtec for specifications and ordering information.

**Note:** Some sizes, styles and options are non-standard, non-returnable.

**Note:** See SFM/TFM for positive alignment feature.

Due to technical progress, all designs, specifications and components are subject to change without notice.

[WWW.SAMTEC.COM](http://WWW.SAMTEC.COM)

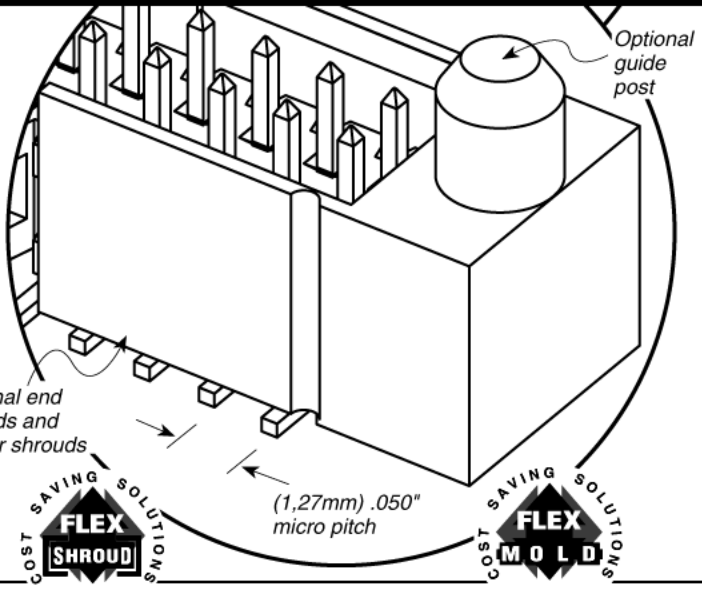
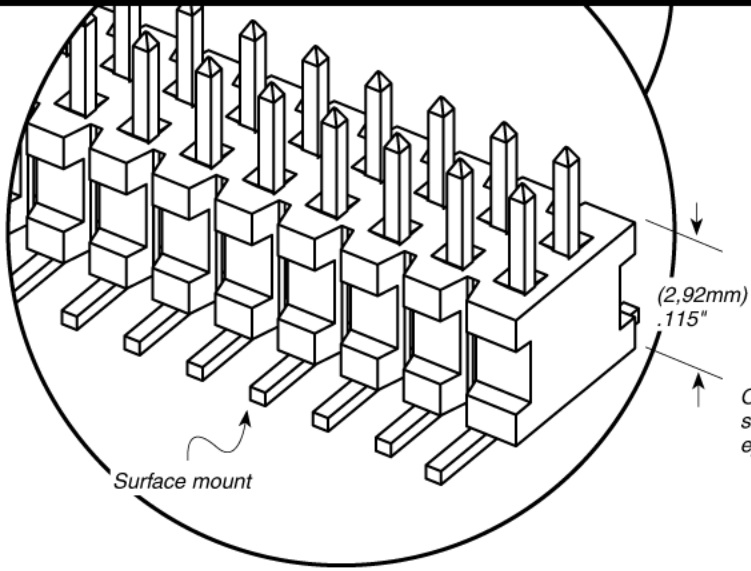
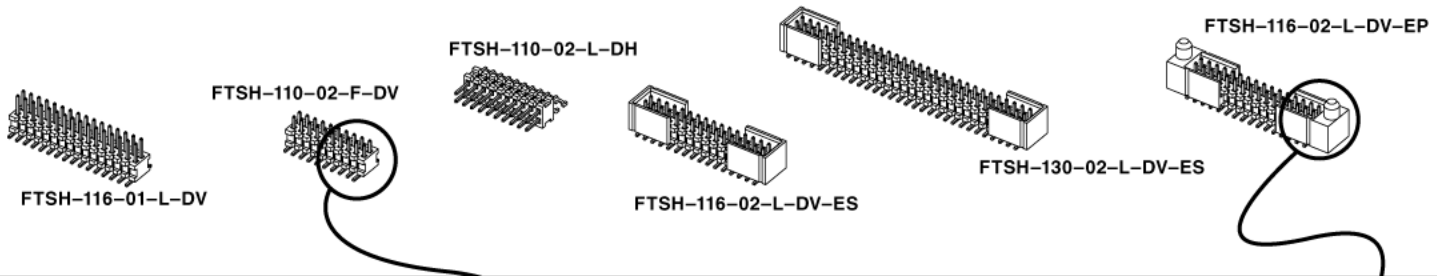

**PLATING OPTION**

**-L**  
= 10µ" (0,25µm) Gold on post, Matte Tin on tail

**-F**  
= Gold flash on post, Matte Tin on tail

**TAIL OPTION**

**-DV**  
= Double Vertical

**-DH**  
= Double Horizontal (Styles -01, -02 & -04 only)

**-MT**  
= Mixed Technology (Styles -01, -02 & -04 only)

**FLEX SHROUD OPTIONS**

(Style -02 & -03 only, -DH not available)  
9 pins/row minimum

**-ES**  
= End Shroud

**-EC**  
= End Shroud with Locking Clip

**-EP**  
= End Shroud with Guide Post

**-EL**  
= End Shroud with Board Lock (Boards are positively locked and cannot be unmated)

**OTHER OPTIONS**

**-K**  
= Mating Shroud (For mating with FFSD Styles -01 only, 05, 08, 10, 13, 17, 20 & 25 pins/row only, 13, 17, 20 & 25 only with shrouds)

**-A**  
= Alignment Pin (-DV 3 positions min.) (-DH 5 positions min.) (Metal or plastic at Samtec discretion)

**-C**  
= (4,00mm) .157" DIA Polyimide film Pick & Place Pad (-DH only)

**-P**  
= Pick & Place Pad (-DV 4 positions min.) (-DH & -MT not available)

**-TR**  
= Tape & Reel Packaging (Tail option -DV & -DH only)  
Flex Shroud options not available except -ES & -EJ

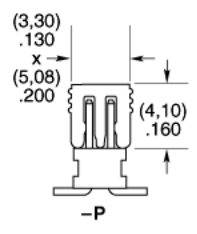
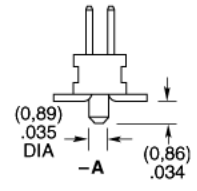
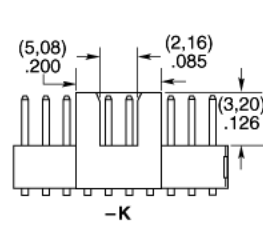
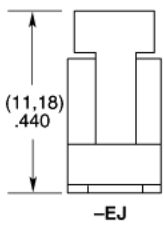
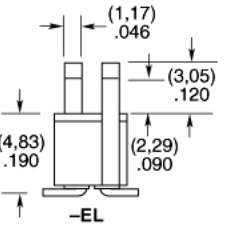
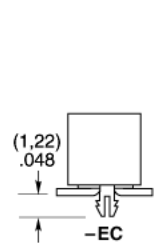
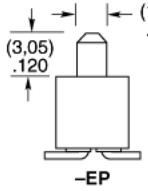
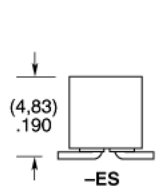

Due to technical progress, all designs, specifications and components are subject to change without notice.

[WWW.SAMTEC.COM](http://WWW.SAMTEC.COM)

SAMTEC USA • Tel: 1-800-SAMTEC-9 or 812-944-6733 • Fax: 812-948-5047  
 SAMTEC GERMANY • Tel: +49 (0) 89 / 89460-0 • Fax: +49 (0) 89 / 89460-299  
 SAMTEC SCANDINAVIA • Tel: +46-84477280 • Fax: +46-87420413  
 SAMTEC ASIA PACIFIC • Tel: 65 6745-5955 • Fax: 65 6841-1502  
 SAMTEC HONG KONG • Tel: 852-26904858 • Fax: 852-26904842  
 SAMTEC SILICON VALLEY • Tel: 408-395-5900 • Fax: 408-395-1520  
 SAMTEC FRANCE • Tel: 01 60 95 06 60 • Fax: 01 60 95 06 61  
 SAMTEC ISRAEL • Tel: 972-3-7526600 • Fax: 972-3-7526690  
 SAMTEC CHINA • Tel: 86-21-61103766 • Fax: 86-21-53854047  
 SAMTEC SOUTH AFRICA • Tel: 27 11 4528112 • Fax: 27 86 6714432  
 SAMTEC UK • Tel: 01236 739292 • Fax: 01236 727113  
 SAMTEC ITALY • Tel: 39 039 6890337 • Fax: 39 039 6890315  
 SAMTEC INDIA • Tel: 91 80 306 21 612 • Fax: 91 80 4152 8187  
 SAMTEC JAPAN • Tel: 81-424-42-8318 • Fax: 81-424-42-8319  
 SAMTEC TAIWAN • Tel: 886 02 2698-3367 • Fax: 886 02 8698-2159  
 SAMTEC ANZ • Tel: 613 9512 7747 • Fax: 613 9512 7745

## X-ON Electronics

Largest Supplier of Electrical and Electronic Components

*Click to view similar products for [Headers & Wire Housings](#) category:*

*Click to view products by [Samtec](#) manufacturer:*

Other Similar products are found below :

[95000-104TRLF](#) [10135584-644402LF](#) [DF62W-EP2022PCA](#) [95000-106TRLF](#) [DF62W-2022SCA](#) [DF62W-EP2022PC](#) [2203348](#) [DF62W-2022SC](#) [1084018](#) [1029039](#) [1084017](#) [802-10-012-10-002000](#) [1112640](#) [1112639](#) [000-34000](#) [0009482033](#) [0009507031](#) [57102-S06-03LF](#) [57202-S52-04LF](#) [PCN6-15S-2.5E](#) [0039019024](#) [58102-G61-06LF](#) [582553-1](#) [0009485154](#) [0009508121](#) [0022285053](#) [0050291907](#) [018731A](#) [LY20-4P-DT1-P1E-BR](#) [02.125.8002.8](#) [60101931](#) [60598-1 \(Cut Strip\)](#) [M1625-3R/100](#) [61062-3](#) [61082-181009](#) [636-1427](#) [638009-1](#) [641938-9](#) [641991-4](#) [644168-1](#) [647662-1](#) [65039-019ELF](#) [65817-002LF](#) [65817-015LF](#) [65863-015LF](#) [66207-023LF](#) [67016-026LF](#) [67046-001LF](#) [67095-007LF](#) [67230-005LF](#)