

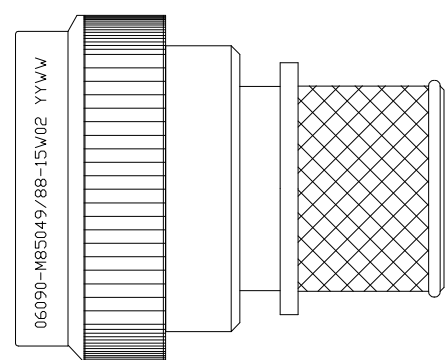

THIS DRAWING IS UNPUBLISHED. RELEASED FOR PUBLICATION  
 © COPYRIGHT - - ALL RIGHTS RESERVED.

REVISIONS					
P	LTR	DESCRIPTION	DATE	DWN	APVD
	E	REV PER ECO 17-004704	6-5-17	CT	EH



SELF-LOCKING  
 SHIELD BAND TERMINATION  
 SHRINK BOOT ACCOMMODATION ADAPTER

1. THIS PRODUCT IS DESIGNED TO TERMINATE A BRAIDED CABLE SHIELD AND A HEAT SHRINKABLE LIPPED BOOT TO A CONNECTOR, AND DESIGNED TO MEET PERFORMANCE REQUIREMENT OF AS85049/88.
2. ALL COMPONENTS SHALL BE PACKAGED AND SUPPLIED IN A PLASTIC BAG AND LABELED WITH M85049/88 DESIGNATION e.g. M85049/88-15W02.
3. PART SUPPLIED WITH STANDARD DETENTED SELF-LOCKING WHICH PROVIDES A POSITIVE AUDIBLE DETENTED COUPLING.
4. THIS ADAPTER MATES TO MIL-DTL-38999 SERIES III AND MIL-DTL-38999 SERIES IV CONNECTORS.
5. FOR MATERIAL AND FINISH INFORMATION REFER TO R85049.  
 FOR ALTERNATIVE MATERIALS AND PLATING FINISHES CONTACT TE CONNECTIVITY.

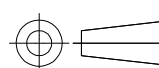
THIS DRAWING IS A CONTROLLED DOCUMENT.		DWN C.C.THOMAS 05JUN2017	 TE Connectivity		
DIMENSIONS: INCHES		CHK E.HALEY 6-5-17			
		APVD E.HALEY 6-5-17	NAME BACKSHELL, STRAIGHT, SELF-LOCKING, SHIELD BAND TERMINATION, SHRINK BOOT ADAPTER		
TOLERANCES UNLESS OTHERWISE SPECIFIED:		PRODUCT SPEC	APPLICATION SPEC		
0 PLC ± - 1 PLC ± - 2 PLC ± - 3 PLC ± - 4 PLC ± - ANGLES ± -		WEIGHT 0	SIZE A3	CAGE CODE 06090	DRAWING NO C-R85049/88
MATERIAL -		FINISH -		RESTRICTED TO -	
CUSTOMER DRAWING			SCALE NTS	SHEET 1 OF 3	REV E

THIS DRAWING IS UNPUBLISHED.

RELEASED FOR PUBLICATION

REVISIONS

© COPYRIGHT - TE Connectivity

ALL RIGHTS RESERVED.

P	LTR	DESCRIPTION	DATE	DWN	APVD
-	-	SEE SHEET 1	-	-	-

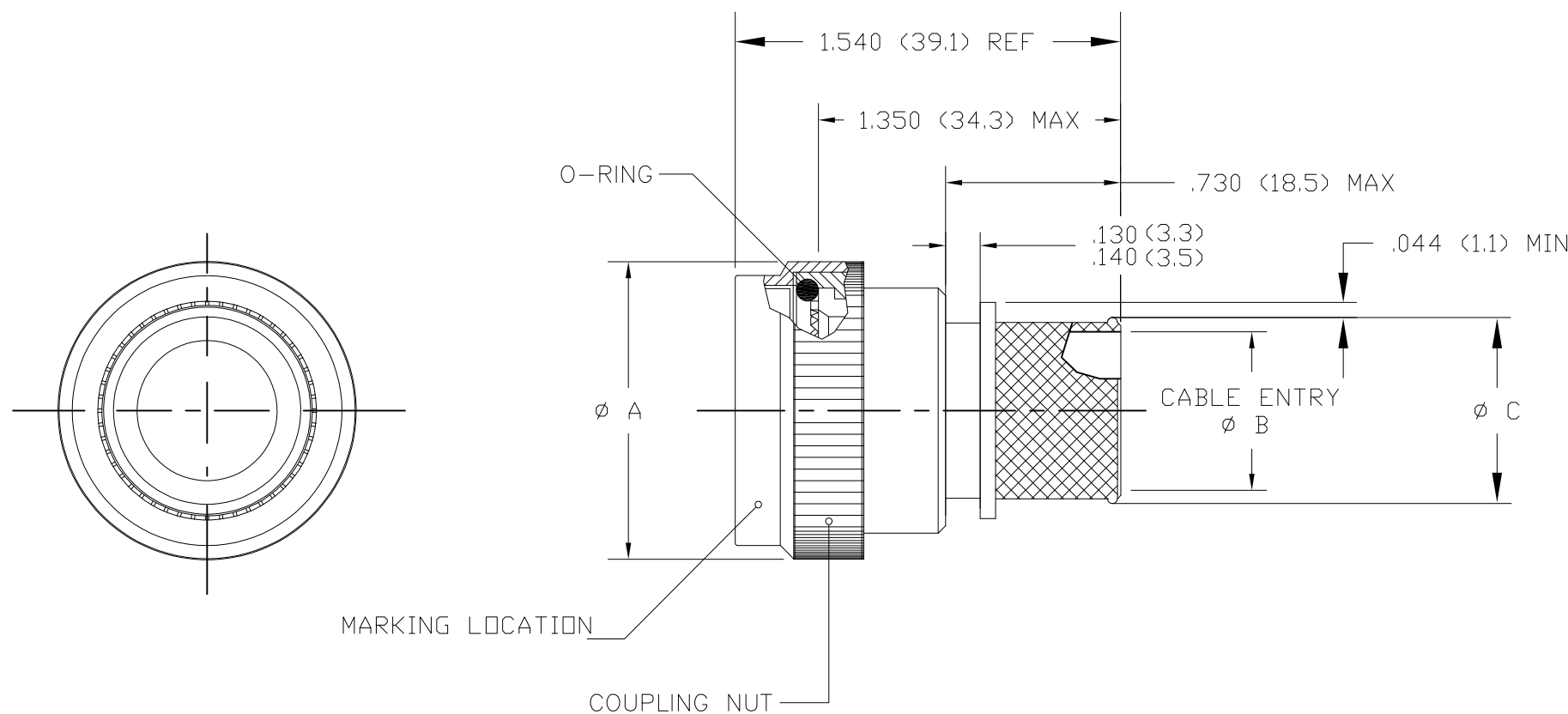

PART NUMBERING

R85049/88 - 15 W 02

- SPECIFICATION SHEET
- CONFIGURATION:
  - (DASH) DETENTED SELF-LOCKING
- ORDER NO.
- FINISH
- ENTRY SIZE

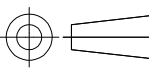
THIS DRAWING IS A CONTROLLED DOCUMENT.		DWN C.C.THOMAS 05JUN2017	 TE Connectivity			
DIMENSIONS: INCHES		CHK E.HALEY 6-5-17				
		APVD E.HALEY 6-5-17	NAME BACKSHELL, STRAIGHT, SELF-LOCKING, SHIELD BAND TERMINATION SHRINK BOOT ADAPTER			
TOLERANCES UNLESS OTHERWISE SPECIFIED:		PRODUCT SPEC	-			
0 PLC ± - 1 PLC ± - 2 PLC ± - 3 PLC ± - 4 PLC ± - ANGLES ± -		APPLICATION SPEC	-			
MATERIAL		WEIGHT	SIZE	CAGE CODE	DRAWING NO	RESTRICTED TO
-		-	A3	00779	C-R85049/88	-
FINISH		CUSTOMER DRAWING		SCALE	SHEET	REV
-				NTS	2 OF 3	E

THIS DRAWING IS UNPUBLISHED. RELEASED FOR PUBLICATION  
 © COPYRIGHT - TE Connectivity ALL RIGHTS RESERVED.

REVISIONS					
P	LTR	DESCRIPTION	DATE	DWN	APVD
-	-	SEE SHEET 1	-	-	-

TABLE I - SHELL SIZE AND DIMENSIONS						
ORDER NUMBER	SHELL SIZE	A MAX DIA	B DIA ±.010 ENTRY SIZE		C DIA REF	
			Ø2	Ø3	Ø2	Ø3
9	A	.858 (21.8)	N/A	.250 (6.4)	N/A	.395 (10.0)
11	B	.984 (25.0)	N/A	.312 (7.9)	N/A	.457 (11.6)
13	C	1.157 (29.4)	.312 (7.9)	.438 (11.1)	.457 (11.6)	.583 (14.8)
15	D	1.279 (32.5)	.438 (11.1)	.562 (14.3)	.583 (14.8)	.707 (18.0)
17	E	1.406 (35.7)	.500 (12.7)	.625 (15.9)	.645 (16.4)	.770 (19.6)
19	F	1.516 (38.5)	.625 (15.9)	.750 (19.1)	.770 (19.6)	.895 (22.7)
21	G	1.642 (41.7)	.625 (15.9)	.812 (20.6)	.770 (19.6)	.957 (24.3)
23	H	1.768 (44.9)	.688 (17.5)	.938 (23.8)	.829 (21.1)	1.083 (27.5)
25	J	1.889 (48.0)	.750 (19.1)	1.000 (25.4)	.895 (22.7)	1.145 (29.1)

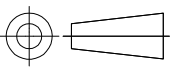
THIS DRAWING IS A CONTROLLED DOCUMENT.		DWN C.C.THOMAS 05JUN2017	 TE Connectivity				
DIMENSIONS: INCHES		CHK E.HALEY 6-5-17					
		APVD E.HALEY 6-5-17	NAME BACKSHELL, STRAIGHT, SELF-LOCKING, SHIELD BAND TERMINATION SHRINK BOOT ADAPTER				
		PRODUCT SPEC -	APPLICATION SPEC -				
MATERIAL -		FINISH -	WEIGHT -	SIZE A3	CAGE CODE 00779	DRAWING NO C-R85049/88	RESTRICTED TO -
CUSTOMER DRAWING			SCALE NTS	SHEET 3 OF 3	REV E		

## X-ON Electronics

Largest Supplier of Electrical and Electronic Components

*Click to view similar products for [Circular MIL Spec Strain Reliefs & Adapters](#) category:*

*Click to view products by [TE Connectivity](#) manufacturer:*

Other Similar products are found below :

[896227-000](#) [899170S004](#) [6000-063-0022](#) [613751-000](#) [CS6624-000](#) [620AB038Z136](#) [620AS001Z108](#) [620AS038Z112](#) [620AS038Z120](#)  
[620AS038Z132](#) [620FB038NF08](#) [620HA038NF13](#) [620HA038NF25](#) [620HA042XM13](#) [620HB049NF17](#) [620HS011NF21](#) [620HS038NF11](#)  
[620HS038Z121](#) [620HS042XM19](#) [620HS042XM25](#) [620HS042XW13](#) [620HS048B17](#) [620MS064NF09](#) [620MS064NF12](#) [620MS065M12](#)  
[620MS065Z107](#) [620MS065ZNU06](#) [630J041M06H](#) [630J041M20H](#) [637S010NF0212H](#) [640830-000](#) [659943-000](#) [66241-10A](#) [CW0597-000](#)  
[CW0598-000](#) [CW0948-000](#) [CY0122-000](#) [M85049/41-6A W/B](#) [M85049/42-12DS](#) [M85049/47N8](#) [M85049/47W18](#) [M85049/51-1-14S](#)  
[M85049/51-1-8W](#) [M85049/51S16S](#) [M85049/60-1N16](#) [M85049/60-2G12W](#) [M85049/69-11N](#) [CZ3661-000](#) [D02922-000](#) [70.360.1628.0](#)