

Interactive Catalog Supplements Catalog PDFs

If you need detailed product information, or help choosing the right product for your application, see our **Interactive Catalog**. Use the **Interactive Catalog** to access the most complete and up-to-date information available.

The **Interactive Catalog** provides an extensive collection of product specifications, application data, and technical literature that can be searched based on criteria you select.

This PDF catalog information was published in November 2000.



Sensing and Control
**Interactive
Catalog...**

**Click this icon to try
the Interactive Catalog.**

Sensing and Control

Honeywell Inc.

11 West Spring Street

Freeport, IL 61032

AML77 barriers and AML78 panel seals	44
AML76 switch guards and AML78 panel plugs, dummy housing	45
AML79 connector block	45
Lamps and LEDs — AML90 series	
AML91 incandescent wedge base T-1¾ lamps and AML92 T-1¾ LEDs	46
Mounting dimensions	47

annunciators which complement AML's universal appeal.

Various controls can be matched with their functions to accommodate the most natural and efficient habit pattern reflex. Keylock operated switches can be used to assure "authorized personnel only" access.

Display flexibility. AML offers a choice of five legend sizes, four button heights, full or split section display, and illumination by incandescent lamps, LED's or neons. Colors are bright and uniform, providing a strong definition and good visibility. (Non-illuminated devices have the same attractive colors.)

Color display options include:

- Transmitted color — color can be distinguished whether lamp is On or Off.
- Dead front — display appears black, until illumination causes legend and color to appear.
- Projected color — white display is diffused with color when illuminated.

effect technology to meet a wide range of position sensing and manual control needs.

Electronic control switches with gold or silver contacts, and 1, 2, or 4 poles, will handle up to 3 amps. Including an encoded version which generates different binary coded outputs merely by changing cam-keyed buttons.

Power duty switches meet line disconnect application needs with 10-amp push-buttons and 15-amp paddle and rocker switches.

max., withdrawal force is 14 lbs. These receptacles are supplied by: AMP Inc., Berg, Augat, Hollingsworth, MALCO, Zierick, and others. Refer to Thomas Register or the Yellow Pages for the location of your local supplier.

- UL recognized, CSA certification.
- Selected listings are certified by VDE and CE. (For compliance status, contact the 800 number.)



- Full-face illumination for high visibility lighted colors.
- Advanced illumination technology combines high-intensity LED in standard T-1-3/4 wedge base lamp package.
- Easy plug-in installation in AML lighted switches and indicators.
- Low operating temperature permits high density, continuous operation with minimal heat build-up.

AML92 Series LEDs have a quad chip assembled in a T-1-3/4 wedge base lamp package. They provide full-face illumination when used with lighted pushbutton, rocker and paddle switches, or indicators equipped with incandescent lamp sockets. For ordering information, refer to **page 46**.

(Released)
14.0 mA
(Operated-
no load)

① Over temperature range of 0° to +55°C (+32° to +131°F) and supply voltage of 4.5 to 5.5 VDC.

② Over temperature range of 0° to +55°C (+32° to +131°F) and supply voltage of 16 VDC.
③ At 24°C. (+75°F)

④ As with all solid state components, performance can be expected to deteriorate as rating limits are approached; however, they will not be damaged unless the limits are exceeded.

● AML20 Series

Contacts	Voltage	Current	Load Type
Silver or Gold-plated Silver	250 VAC 125 VAC 24 VDC	2 Amps 3 Amps 2 Amps	75% Power Factor 75% Power Factor Resistive
Gold	125 VAC/DC	100 mA	Resistive

● AML30 Series

Voltage	Current		Load Type
	Pushbuttons	Rockers or Paddles	
125 VAC	10 amps	15 amps	60% power factor
250 VAC	10 amps	15 amps	60% power factor

Full Guard Bezel:
AML11H Square Non-Lighted
AML11J Square 1 Lamp Ckt.
AML11K Rect. Non-Lighted
AML11L Rect. 1 Lamp Ckt.
AML11M Rect. 2 Lamp Ckts.



C
 14 V Lamp*

E
 28 V Lamp*

(Printed
 Circuit, or
 Push-On)



* Lamps will be installed per each lamp circuit specified in the Housing Type.

Example: **AML11BBA2EA**
 Square pushbutton switch housing, non-lighted; black bezel; .110 x .020 termination;
 momentary action; current sinking output for use with 4.5 volt supply.

CURRENT SINKING OUTPUT
AML10 SERIES

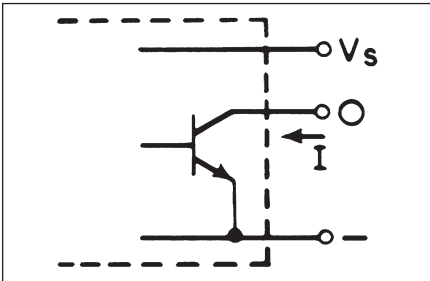

A permanent magnet plunger moves adjacent to the Hall effect integrated circuit to give a digital, current sinking normally high output.

T	10 V
W	15 V
X	24 V

AML21G Rect. 2 Lamp Ckts.

Full Guard Bezel:
AML21H Square Non-Lighted
AML21J Square 1 Lamp Ckt.
AML21K Rect. Non-Lighted
AML21L Rect. 1 Lamp Ckt.
AML21M Rect. 2 Lamp Ckts.

6 V Lamp*

C
 14 V Lamp*

E
 28 V Lamp*

3
 .025 × .025
 (Printed Ckt. or
 Push-On)

	Alt. Action AB 1-Pole AD 2-Pole CD 4-Pole
Gold Contacts	Mom. Action BA 1-Pole BC 2-Pole DC 4-Pole
	Alt. Action BB 1-Pole BD 2-Pole DD 4-Pole
Gold-Plated Silver Contacts	Mom. Action EA 1-Pole EC 2-Pole
	Alt. Action EB 1-Pole ED 2-Pole

* Lamps will be installed per each lamp circuit specified in the Housing Type.

Example: **AML21BBA2AA**
 Square pushbutton switch housing non-lighted; black bezel; .110 × .020 termination; momentary action; 1-pole, double-throw; silver contacts.

R	V*
S	5V
T	10V
W	15V
X	24V

Protection
for LED

Alt. Action
BB 1-Pole
BD 2-Pole
DD 4-Pole

Gold-Plated Silver Contacts

Mom. Action
EA 1-Pole
EC 2-Pole

Alt. Action
EB 1-Pole
ED 2-Pole

* See LED information for devices without current limiting resistor, page 46.

Example: **AML22CBB2AA**

Square pushbutton switch housing with one LED, black bezel; red LED (without resistor); .110 × .020 termination; momentary action, 1-pole, double-throw; silver contacts.

CONTACT ARRANGEMENT

1, 2 or 4 poles: Form C



* Lamps will be installed per each lamp circuit specified in the Housing Type.

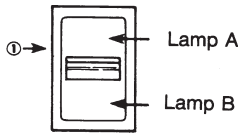

① The "MICRO SWITCH" identification is shown on this side of the switch housings.

Example: **AML23EBA2AA01**
 Rectangular non-lighted paddle switch housing; black paddle and bezel; .110 × .020 terminals; with one circuit ON and one circuit OFF in each extreme operator position (maintained).

CIRCUITRY

Silver Contacts	Gold Contacts	2-Position		3-Position			
AA	BA						
AC (Non-illuminated switches only)	BC						
CA	DA						
CC (Non-illuminated switches only)	DC						

OPERATING ACTION

2-Position:		
Maint.	01 None	Maint.
Mom.	02 None	Maint.
Maint.	03 None	Mom.
3-Position:		
Maint.	04 Maint.	Maint.
Mom.	05 Maint.	Mom.
Maint.	06 Maint.	Mom.
Mom.	07 Maint.	Maint.

* See LED application information for devices without current-limiting resistor, page 46.

Example: **AML25FBB2AA01RX**

Rectangular paddle switch; illuminated with one red LED, this device has a black paddle and bezel, and .110 × .020 terminals; with one circuit ON and one circuit OFF in each extreme operator position (maintained).

NOTE: For further information on replacement LED's, call the 800 number.

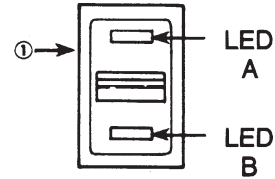
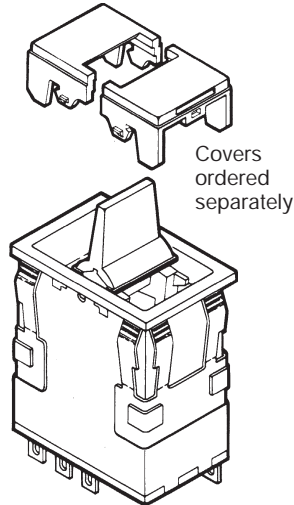

① The "MICRO SWITCH" identification is shown on this side of the switch housings.

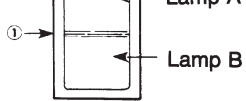

① The "MICRO SWITCH" identification is shown on this side of the switch housings.

Example: **AML24EBA2AA01**

Rectangular non-lighted rocker switch housing; black bezel; .110 × .020 terminals; with one circuit ON and one circuit OFF in each extreme operator position (maintained).

CIRCUITRY

Silver Contacts	Gold Contacts	2-Position		3-Position			
AA	BA						
AC (Non-illuminated switches only)	BC						
CA	DA						
CC (Non-illuminated switches only)	DC						

OPERATING ACTION

2-Position:		
Maint.	01 None	Maint.
Mom.	02 None	Maint.
Maint.	03 None	Mom.
3-Position:		
Maint.	04 Maint.	Maint.
Mom.	05 Maint.	Mom.
Maint.	06 Maint.	Mom.
Mom.	07 Maint.	Maint.

F
24 V

.110 × .020
w/Diode
for LED
protection

BA
CA
DA
circuitry

* See LED application information for devices without current-limiting resistor, page 46.

Example: **AML26FBB2AA01RX**

Rectangular rocker switch; illuminated with one LED, this device has a black bezel, .110 × .020 terminals; with one circuit ON and one circuit OFF in each extreme operator position (maintained).

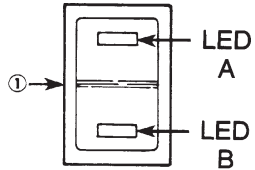

① The "MICRO SWITCH" identification is shown on this side of the switch housings.

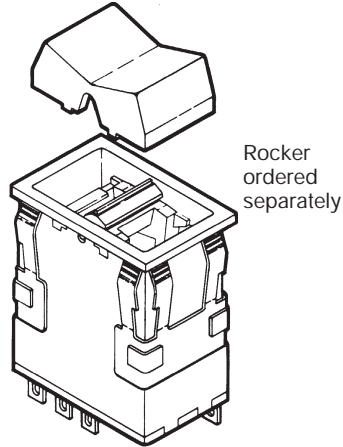

One key per listing.

Key Combination	Key Code	Catalog Listing
BA	110	30PA101-AML
BB	109	30PA102-AML
BD	107	30PA104-AML
BE	106	30PA105-AML
BS	117	30PA117-AML
BT	118	30PA118-AML
BV	119	30PA119-AML
BW	120	30PA120-AML

⚠ Specify different key combinations to acquire different keys, i.e.; AML27ABK2AA21BB and AML27ABK2AA21BE have different keys. AML27ABK2AA21BB and AML27ABK3BC25BB have identical interchangeable keys.
 Example: **AML27ABK2AC28BB**
 Square housing; black bezel and button; .110 × .020 terminals; 2-pole double-throw; silver contacts; 3-position maintained and key code "BB".

Mom.	Maint.	Maint.
Maint.	Maint.	Maint.
Maint.	Maint.	Maint.
Maint.	Maint.	Mom.
Maint.	Maint.	Mom.

28 and **29** operating actions should be used with Key Combinations BA and BB.

* Key out in both positions.
 ** Key out in all three positions.
 *** Key out in center and CW positions.

† Key out in center and CCW positions.
 †† Key out in CCW only.

CIRCUITRY

2-Position Switches:

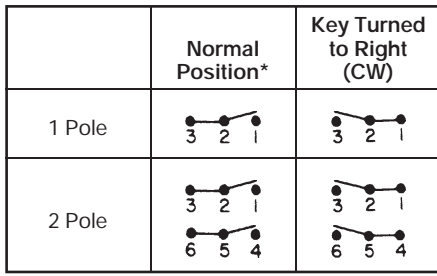

Note: These keys fit the 5-bit keylocks in the Order Guide.

3-Position Switches (Available in 2-pole only.)

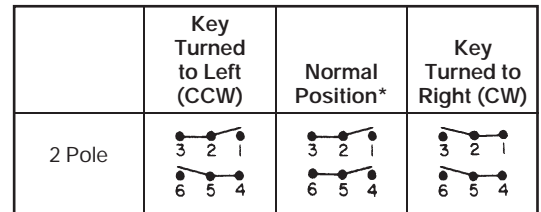

* Circuit remains the same with key in or out.

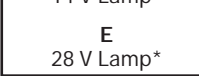

* Lamps will be installed per each lamp circuit specified in the Housing Type.

Example: **AML31EBA4AC**

Rectangular pushbutton switch housing, non-lighted; black bezel; .187 × .020 terminals; momentary action; 2-pole, single-throw, normally open, Form X.

AML32 ORDER GUIDE

AML32 has neon lamp wired to 125 or 250 VAC resistor.

AML32 F	B	C	7	AC
Housing Type	Bezel Color	Neon Lamp Voltage/Color	Terminal Type Lamp Circuit	Circuitry Codes
Standard Bezel: AML32F Rect. 1 Neon Lamp Full Guard Bezel: AML32L Rect. 1 Neon Lamp	B Black	Red B 125 VAC C 250 VAC Clear K 125 VAC L 250 VAC Green M 125 VAC P 250 VAC	4 .187 × .020 (Solder or Quick-Connect) with isolated lamp circuit 7 .187 × .020 with integral lamp circuit	2-Pole, Single-Throw Normally-Open, Form X: AD Alt. Action AC Mom. Action

Example: **AML32FBC7AC**

Rectangular pushbutton switch housing; black bezel; 250 volt, red neon lamp; .187 × .020 terminals with integral lamp circuit; momentary action; 2-pole, single-throw, normally open, Form X.

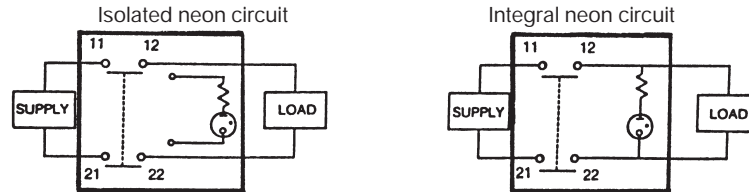

AML35
Rectangular
1 Lamp Ckt.

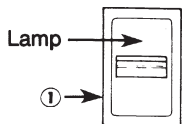

6 V Lamp*
C
14 V Lamp*
E
28 V Lamp*

Single-Throw,
Normally-Open)
AC
2-Pole
(Two Form A)

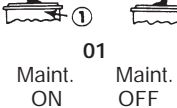

*Lamps will be installed per each lamp circuit specified in the Housing Type.

AML35 ORDER GUIDE

AML35 has neon lamp wired to 125 or 250 VAC resistor.

AML35 F

Housing
Type

AML35 F
Rectangular
1 Neon Lamp

B

Operator/Bezel
Color

B
Black/Black

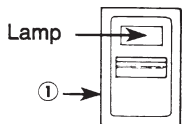

B

Neon Lamp
Voltage

Red
B
125 VAC

C
250 VAC

Green
M
125 VAC

P
250 VAC

4

Terminal Type/
Lamp Circuit †

4
.187 × .020
(Solder or
Quick-Connect)
With Isolated
Lamp Circuit

7
.187 × .020
With Integral Lamp
Circuit (Available
with 2-Pole
devices only

AA

Circuitry
Codes

Silver Contacts:
AA
(One Form A
Single-Throw)
Available only
with isolated
lamp circuit,
term. type 4.

AC
2-Pole
(Two Form A)

01

Operating
Action

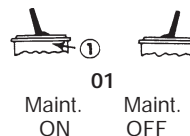

① The "MICRO SWITCH" identification is shown on this side of the switch housing.

Example: **AML35FBB4AA01**

Rectangular paddle switch housing;
black paddle and bezel; 125 VAC neon
lamp; .187 × .020 terminals with isolated

lamp circuit; 1-Pole Form A Single-Throw;
with circuit ON in one extreme position
and OFF in the other (maintained).

28 V Lamp*

*Lamps will be installed per each lamp circuit specified in the Housing Type.

AML36 ORDER GUIDE

AML36 has neon lamp wired to 125 or 250 VAC resistor.

AML36 F	B	B	4	AA	01
Housing Type	Bezel Color	Neon Lamp Voltage	Terminal Type/ Lamp Circuit	Circuitry Codes	Operating Action
AML36 F Rectangular 1 Neon Lamp	B Black	Red B 125 VAC C 250 VAC Green M 125 VAC P 250 VAC	4 .187 × .020 (Solder or Quick-Connect) With Isolated Lamp Circuit 7 .187 × .020 (Solder or Quick-Connect) With Integral Lamp Circuit	Silver Contacts: AA (One Form A Single-Throw) Not available with terminal type 7 AC 2-Pole (Two Form A)	 01 Maint. ON Maint. OFF

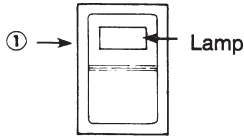

① The “MICRO SWITCH” identification is shown on this side of the switch housing.

Example: **AML36FBB4AA01**

Rectangular rocker switch housing; black bezel; 125 VAC neon lamp; .187 × .020 terminals with isolated lamp circuit; 1-Pole Form A single-throw; with circuit ON in one extreme position and OFF in the other.

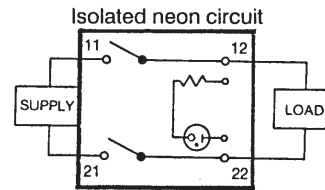
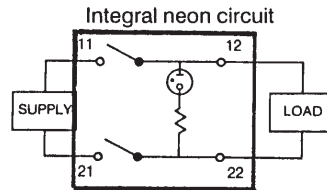



AML42C
(Use AML52-C/-A
pushbuttons only.
Page 31.)



AML42S

Housing Type
AML42 C Square 1 LED
AML42 S Compact 1 LED

Bezel Color
B Black

Yellow		Green	
H	V*	R	V*
J	5 V	S	5 V
K	10 V	T	10 V
L	15 V	W	15 V
M	24 V	X	24 V

LED Color/ Voltage	
Red	
B	V*
C	5 V
D	10 V
E	15 V
F	24 V

Terminal Type/ Diode Protection	
2 .110 × .020 (Solder or Q.C.)	8 .110 × .020 w/diode to protect LED
3 .025 × .025 (Printed Circuit or Push-On)	9 .025 × .025 w/diode to protect LED

Example: **AML42SBC2**
Compact indicator with black bezel; 5 volt
red LED; .110 × .020 termination.

* See LED application data, page 46, for these
devices without current-limiting resistor.



CAP

NEVER

Film legends offer a choice of negative or positive formats. (Note: human factors engineers generally favor negative annunciator messages, reserving the positive format for use if special attention is necessary, such as "PAPER JAM.")

When unlighted, the legend is hidden (dead front).

AML45/59 solid state LED annunciators are a state-of-the-art advancement over traditional back-lighted legend displays which utilize incandescent lamps. The LED light source imparts the benefits of solid state long-life and reliability, with low power requirements. Operating life is measured by years, instead of hours.

The AML45 housing has two high efficiency LED's which illuminate color filters and film legends located in the snap-on AML59 cap assembly. There is a choice of full face one-color and split one-color or two-color displays. Color options are red, green, and yellow.

NEGATIVE

When illuminated, colored legend appears against a black background.

NEGATIVE

POSITIVE

When illuminated, black legend appears against a colored background.

POSITIVE

This annunciator is totally compatible with other devices in the MICRO SWITCH AML Advanced Manual Line both in front of, and behind the panel. Two of them fit in the same space as a rectangular AML indicators or switch. All terminals exit at AML's standard 1.7-inch depth for convenient, single-level wiring.

Type	Housing Bezel	Voltage*	Type	Side 1	Side 2
AML45 R 2 LED's (For use with Full Screen)	W White	A 2.4 V	2 .110 × .020 (Solder or Quick-Connect)	R Red	R Red
AML45 S 2 LED's (For use with Split Screen)	K Black	B 5 V	3 .025 × .025 (Printed Circuit)	Y Yellow	Y Yellow
		C 10 V	8 .110 × .020 with diode protection for LED's	G Green	G Green
		D 15 V			
		F 24 V			

* Current draw is 20 mA. "B", "C", "D" and "F" have built-in current limiting resistors.

Example: **AML45SWA2RY**
Split screen type housing with white bezel, 2.4 V LED's, .110 × .020 termination, red LED in Side 1 and yellow LED in Side 2.

Suggested printed circuit board layout for up to ten AML45 units assembled in an AML61 assembly:

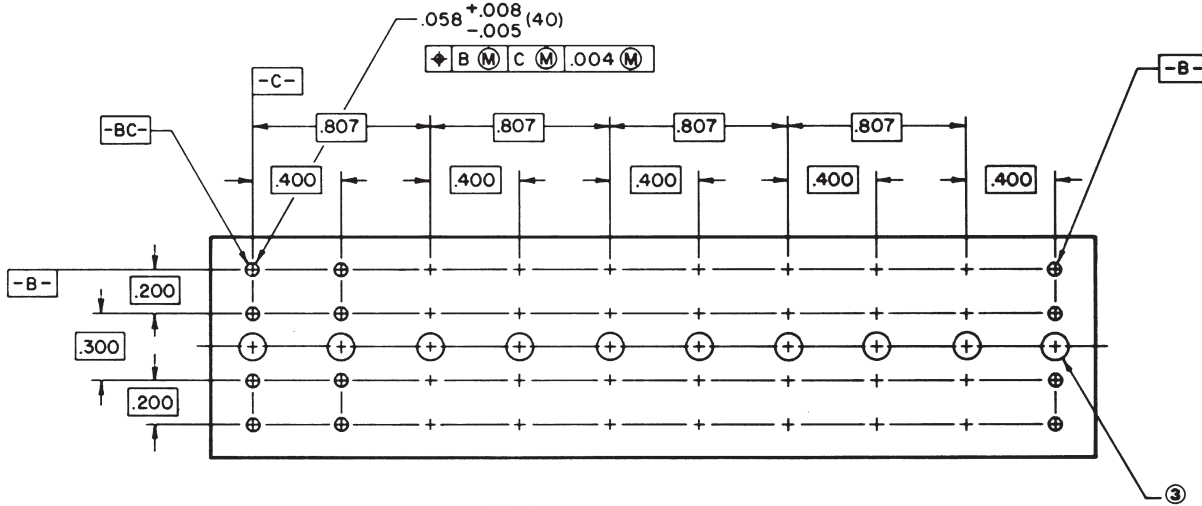

© .125" minimum diameter hole recommended to permit access to annunciator, allowing it to be driven out panel front should replacement become necessary.

and positive standard film legends in the type style (14-point Helvetica condensed bold) shown below. Use separate legend sheet for each AML59 catalog listing and attach it (them) to your purchase order.

ABCDEFGHIJKLMNQRST

UVWXYZ &?!():',.-/#% 1/2

\$0123456789 ↓

Approx. .165" —┘

Cap Style	Cap Color	Legend Type	Filter Color		
			Full Screen	Split Screen	
AML59-R Full Screen	K Black	10 No Legend	R Red	R Red	R Red
AML59-S Split Screen		20 Negative Film Legend	Y Yellow	Y Yellow	Y Yellow
		21 Positive Film Legend	G Green	G Green	G Green

Examples:

AML59-RK10R

Full screen style, black cap, no legend, and red filter.

AML59-SK20RY

Split screen style, black cap, negative film legend, red and yellow color filters.

AML59 Legend Sheet

Account NO _____

Use this form to describe film legends to be used with AML59 Series Cover Assemblies

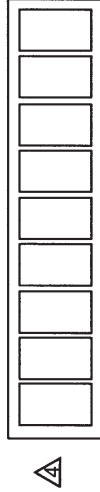
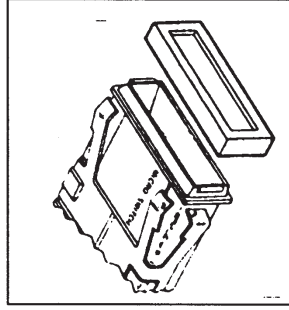

Style "R" (Full Screen)

Special Direction _____

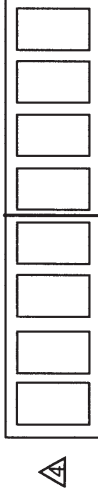
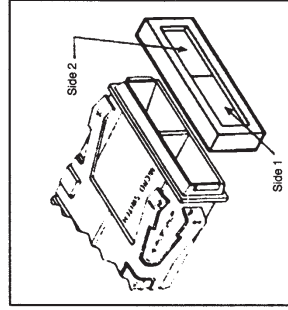

Style "S" (Split Screen)

Special Direction _____

NOTES:

- Legends must be designed to properly assemble to housings, which are to be installed with the MICRO SWITCH logo "up".
- All legends will be centered unless special directions are given.
- Standard legends are 14 pt. helvetica, condensed - Bold. A thru Z and numerals 0 thru 9 are standard.
- Legend Type: - Type "20" **NEGATIVE** - Type "21" **POSITIVE**

AML51 LENS ORDER GUIDE (All possible color combinations may not be available.)
 For incandescent display AML41J, K, and L lens style indicators only.

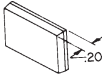
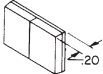
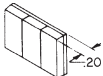
<u>AML51-J</u>	<u>10</u>	<u>R</u>		
Lens style	Display/Legend Type	Full Color or 1st Color Split	2nd Color Split	3rd Color Split
 AML51-J	Transmitted Color 10 No legend 20 With legend Transmitted Color (Clear cap and color insert) 11 No legend 21 With legend Dead Front (Smoky gray cap and color insert) 30 No legend 40 With legend ****Projected Color (White cap and color insert) 50 No legend 60 With legend	R Red Y Yellow G Green B Blue W**** White A** Amber	R Red Y Yellow G Green B Blue W**** White A** Amber	R Red Y Yellow G Green B Blue W**** White A** Amber
 AML51-K				
 AML51-L				

** Not available with projected color.
 **** Insert is clear for projected color when "W" is used.

AML51 lens buttons provide added display area by snapping onto and covering the bezel of AML41J, K, and L indicators. They do not fit other indicators or switches.

Example: **AML51-J10R**
 Rectangular lens type button; full color; transmitted color, no legend; red.

HOW TO ORDER BUTTON LEGENDS

When specifying legended buttons, submit a legend order sheet to cover each listing. To insure proper legend orientation, AML housings (when viewed from the panel front) should have the "MICRO SWITCH" identification facing UP on square devices and UP or to the LEFT on rectangular.

Button legend order sheets are shown on the following pages. Reproduce them on your office copier.







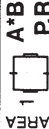

Legend Sheet	Form No.
AML51 Pushbuttons	FO-63394
AML51 Lens buttons	FO-63395
AML52 Pushbuttons	FO-63504
AML53 Paddle switch covers	FO-63567
AML55 Paddle switch covers	FO-63565
AML54 Rockers	FO-63566
AML56 Rockers	FO-63564

AML Pushbutton Legend Sheet/Product Specification

Page _____ of _____

Account NO 126 - 284

LEGEND ORDER GUIDE

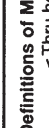
Button: Type Orientation	Figure NO	Max Lines/Area			Max Characters/Line						
		5/64	7/64	9/64	13/64	5/16	5/64	7/64	9/64	13/64	5/16
1  AREA	1	4 ^{*3}	3 ^{*2}	2 ^{*1}	1 ^{*1}	7 ^{*5}	5 ^{*4}	5 ^{*3}	3 ^{*2}	1 ^{*1}	Butt File
1  AREA	2	4 ³	3 ²	2 ¹	1 ¹	7 ⁵	5 ⁴	5 ³	3 ²	1 ¹	
1  AREA	3	1 ¹	1 ¹	0 ⁰	0 ⁰	7 ⁵	5 ⁴	5 ³	0 ⁰	0 ⁰	
1  AREA	4	4 ^{*3}	3 ^{*2}	2 ^{*1}	1 ^{*1}	11 ^{*10}	9 ^{*8}	8 ^{*7}	5 ^{*5}	3 ^{*3}	
1  AREA	5	6 ^{*6}	4 ^{*4}	3 ^{*3}	2 ^{*2}	7 ^{*5}	5 ^{*4}	5 ^{*3}	3 ^{*2}	1 ^{*1}	
1  AREA	6	4 ³	3 ²	2 ¹	1 ¹	11 ⁹	9 ⁸	8 ⁷	5 ⁵	3 ³	
1  AREA	7	6 ⁶	4 ⁴	3 ³	2 ²	7 ⁵	5 ⁴	5 ³	3 ²	1 ¹	
1  AREA	8	1 ¹	1 ¹	0 ⁰	0 ⁰	11 ¹⁰	9 ⁸	8 ⁷	0 ⁰	0 ⁰	
1  AREA	9	5 ⁰	4 ⁰	3 ⁰	2 ⁰	8 ⁰	6 ⁰	6 ⁰	3 ⁰	1 ⁰	

Definitions of Markings

Thru holes to snap into indicator housings
 internal reliefs to snap over switch plunger tabs

Standard Legend Placement -

Use special legends sec. for other placements
 1. Transmitted Color → Legend on outer shell (Button)
 2. Dead Front - Legend on Insert
 3. Projected Color - Legend on outer shell (Button)
 4. Transmitted color with clear cap legend on insert

LEGEND ORDER CHART

Customer Part No	Fig No	Type Size			Ink Color		But- ton Qty	1st Line	2nd Line	3rd
		5/64	7/64	9/64	13/64	5/16				
							1			
							2			
							1			
							2			
							1			
							2			
							1			
							2			
							1			
							2			

FO-83394-K

AML Lens Legend Sheet/Product Specification

Page ___ of ___

Account No _____

LEGEND ORDER GUIDE

Button: Type Orientation	Figure No	Max Lines			Max Characters									
		5/64	7/64	9/64	13/64	5/16	7/64	9/64	13/64	5/16				
AREA 1 J	1	4	3	3	2	2	1	1	14	11	10	7	6	3
AREA 1 2 K	2	4	3	3	2	2	1	1	6	6	5	6	3	1
AREA 1 2 3 L	3	4	3	3	2	2	1	1	4	3	3	2	1	1
AREA 1 J	4	4	3	3	3	3	2	2	9	7	6	7	4	2
AREA 1 2 K	5	3	3	2	2	1	1	1	8	7	6	7	4	2
AREA 1 2 3 L	6	2	2	1	1	1	0	0	8	7	6	7	4	0

Standard Legend Placement

1. Transmitted Color — Legend on outer shell (Button)
2. Dead Front - Legend on Insert
3. Projected Color - Legend on outer shell (Button)

LEGEND ORDER CHART

Customer Part No	Fig No	Type Size		Ink Color		But- ton Qty	Legend D
		5/64	7/64	9/64	13/64		
						1	Sequence: Left-to-Right 2nd Line
						2	
						3	
						1	
						2	
						3	
						1	
						2	
						3	
						1	
						2	
						3	

Sheet Prepared By: _____ (Signature)

FO-63395-E



30 No legend
40 With legend on insert
*****Projected Color**
 (White cap and color insert)
50 No legend
60 With legend on cap

R Black
L* Gray
A** Amber

R Black
L* Gray
A** Amber

* Not for lighted display.
 ** Not available with projected color.
 *** Insert is clear for projected color when "W" is used.

AML55 PADDLE SWITCH COVER ORDER GUIDE (All possible color combinations may not be available.)

For AML35 neon display.



10

Display/Legend Type

Transmitted Color
10
 No Legend

20
 With Legend

R

Lens Color

T
 Clear

R
 Red

Y

Cover Color

R
 Red
Y
 Yellow
G
 Green
B
 Blue
W
 White
K
 Black
L
 Gray

AML55-N covers have a colored lenticular lens window which extends over the neon lamp.

Example: **AML55-N10RY**
 Full neon paddle switch cover; with transmitted color, no legend; red lens and yellow cover.

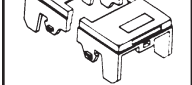

Two-Piece Cover
(For two LED's)



AML55-E, -T, and -H covers have an open window which allows LED's to be flush with the cover surface.

* Notes:

¹ Only one color code letter is necessary for AML55-E 1/2 covers.

² To order a 1/2-cover without the LED "window," specify an AML53-E listing from the previous page.





Example: **AML55-T10YR**

Two-piece cover; with LED window in one side, transmitted color, no legend; yellow (LED side) and red (non-LED side).

AML Paddle Operator (Cover) Legend Sheet/Product S

Account NO 126 - 284

LEGEND ORDER GUIDE

Button: Type Orientation	Figure No	Max Lines/Area				Max Characters/Line													
		5/64	7/64	9/64	13/64	5/16	5/64	7/64	9/64	13/64	5/16								
AREA 1 	1	2	2	2	1	1	1	1	0	1	0	7	5	5	4	3	2	1	0
AREA 1 	2	2	2	2	1	1	1	1	0	1	0	7	5	5	4	3	2	1	0
AREA 1 	3	2	2	2	1	1	1	1	0	1	0	7	5	5	4	3	2	1	0
AREA 2 	2	1	1	1	1	1	1	1	0	1	0	7	5	4	4	2	0		

Standard Legend Placement – 1. Transmitted Color—Legend on outer shell (Button Use Special Legends Section for other placements.)
 2. Dead Front—Legend on insert
 3. Projected Color - Legend on outer shell (Button)
 4. Transmitted color with color with clear cap legend on insert.
 5. All legends will be centered within the legenable areas.

LEGEND ORDER CHART

Customer Part No	Fig No	Type Size				Ink Color				But- ton Qty	Area 1		
		5/64	7/64	9/64	13/64	5/16	Black	White	1st Line		Sequence: Left-to-Right or 2nd Line		

FO-63567-F _____ (Signature) _____ (Date)

AML Paddle (Cover) Legend Sheet For LED and Neon

Account NO 126-284

Legend Order Guide											
Cover Type Orientation	Figure No	Max Lines/Area			Max Characters/Line						
		5/64	7/64	9/64	13/64	5/16	5/64	7/64	9/64	13/64	5/16
	1	1	1	1	0	0	7	5	5	0	0
	2	1	1	1	0	0	7	5	5	0	0
Side 1: Side 2:	3	1	1	1	0	0	7	5	5	0	0
Side 2:	4	2	2	2	1	1	7	5	5	3	1
Side 1: Side 2:	5	1	2	1	0	0	7	5	5	0	0
		2	2	2	1	1	7	5	5	3	1

Standard Legend Placement – Use Special Legends Section for other placements.

1. All Legends will be centered within the legible areas

LEGEND ORDER CHART

Customer Part No	Fig No	Type Size		Ink Color		But ton Qty	Area 1			
		5/64	7/64	9/64	13/64		5/16	1st Line	Sequence: Left-to-Right 2nd Line	

FO-63565-C _____ (Signature) _____ (Date)

NOTE: AML54-F10 and AML54-F20 are one-piece, one-color full rockers. Thus only one color code letter is necessary when ordering. Include a two letter code for all other AML54-E (and AML54-T) catalog listings.

*Not for lighted display.

** Not available with projected color or dead front.

***Insert is clear for projected color when "W" is used.

† Not available for use with AML34 power switches.

Example: **AML54-F10R**

Full rocker; with transmitted color, no legend; red.

AML56 ROCKER OPERATOR ORDER GUIDE

For AML36 neon display.

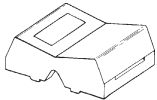
<u>AML56-N</u>	<u>10</u>	<u>R</u>	<u>Y</u>
Rocker Operator Type	Display/Legend Type	Lens Color	Rocker Color
AML56-N  Full Rocker with Colored Lens	Transmitted Color 10 No Legend 20 With Legend	T Clear R Red Y Yellow	R Red Y Yellow G Green B Blue W White K Black

AML56-N rockers have a colored lenticular lens window which extends over the neon lamp.

Example: **AML56-N10RY**

Full rocker; with transmitted color, no legend; yellow rocker and red lens.

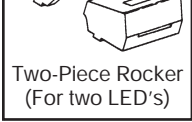

Two-Piece Rocker
(For two LED's)



Example: AML56-T10RB

Two-piece rocker; with LED window in one side, transmitted color, no legend; red (LED side) and blue (non-LED side).

*** Notes:**

¹ Only one color code letter is necessary for AML56-E 1/2-rockers. AML56-E, -T, and -H rockers have an open window which allows LEDs to be flush with the rocker surface.

² To order a 1/2-rocker without the LED "window," specify an AML54-E listing from the previous page.

AML Rocker Legend Sheet/Product Specification

Page ___ of ___

Account NO 126-284

Legend Order Guide

Button Type Orientation	Figure No	Max Lines/Area				Max Characters/Line									
		5/64	7/64	9/64	13/64		5/16								
							5/64	7/64	9/64	13/64	5/16				
AREA 1 1 E	1	2	2	2	1	1	1	0	7	5	5	3	1	Button Ettler	
		2	2	2	1	1	1	0	7	5	4	4	2		
AREA 1 1 E	2	2	2	2	2	1	1	1	0	7	5	4	5	4	1
		2	2	2	2	1	1	1	0	7	5	4	3	2	1
AREA 2 2 F	3	2	2	2	2	1	1	1	0	7	5	4	5	4	1
		2	2	2	2	1	1	1	0	7	5	4	3	2	1
AREA 2 2 T	4	2	2	2	2	1	1	1	0	7	5	4	5	4	1
		2	2	2	2	1	1	1	0	7	5	4	3	2	1

Standard Legend Placement - 1. Transmitted Color—Legend on outer shell (Button

Use Special Legends Section *2. Dead Front—Legend on insert

*3. Projected Color - Legend on outer shell (Button)

*4. Transmitted color with clear cap legend on insert.

*NOT AVAILABLE WITH

AML 34 SERIES

5. All legends will be centered within the legendarable areas.

LEGEND ORDER CHART

Customer Part No	Fig No	Type Size			Ink Color		But- ton Qty	Area 1 Sequence: Left-to-Right c	
		5/64	7/64	9/64	13/64	5/16		Black	White

FO-63566 F

(Signature)

(Date)

AML Rocker Legend Sheet/Product Specification

Account NO 126-284

Page _____ of _____

Legend Order Guide																
Button Type Orientation	Figure No	Max Lines/Area			Max Characters/Line											
		5/64	7/64	9/64	13/64	5/16	5/64	7/64	9/64	13/64	5/16					
	1	1	1	1	0	0	0	0	0	0	7	5	5	3	0	
	2	1	1	1	0	0	0	0	0	0	7	5	5	3	0	
	3	1	1	1	0	0	0	0	0	0	7	5	5	3	0	
	4	2	2	2	1	1	1	1	1	1	7	5	5	5	3	1
	5	1	2	1	1	0	1	0	1	0	7	5	5	5	3	0

Standard Legend Placement – 1. All legends will be centered within the legendable areas.
Use Special Legends Section for other placements.

LEGEND ORDER CHART

Customer Part No	Fig No	Type Size		Ink Color		But-ton Qty	Area 1												
		5/64	7/64	9/64	13/64		5/16	1st Line	Sequence: Left-to-Right o 2nd Line										

FO-88664-E

(Signature)

(Date)

Rect. cans:

AML61 E
(Plain finish)

AML61 K
(Black finish)

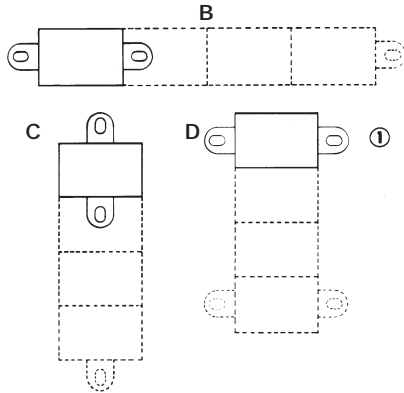

10
11*
12*

*A, C, D & E
orientation only.

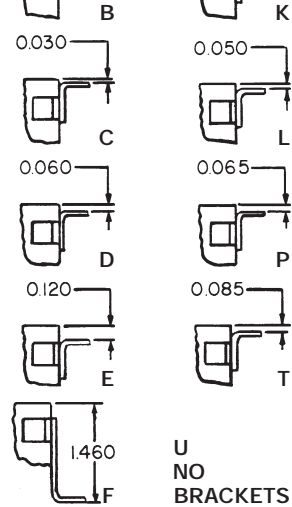

① To order one rectangular can with mounting brackets on short sides, specify AML61EB1____ or AML61KB1____.

Example: AML61EC5A

Five rectangular cans, plain finish (un-painted), long sides abutting; type **A** mounting brackets on long sides, located flush with switch or indicator bezel. (Type **T** bracket brings top of annunciator bezel flush with top of .160 in./4,1 mm panel.)

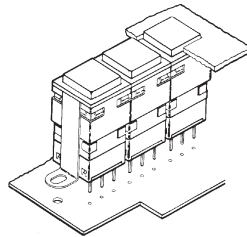

This strip has Type F brackets for P.C. board mounting.

NON-STANDARD ASSEMBLIES

Use the order form on the following page to specify non-standard AML61 strip or matrix assemblies. You may reproduce it on your office copier, or order pads from the 800 number. Request FO-63558.

AML75 PANEL SEAL

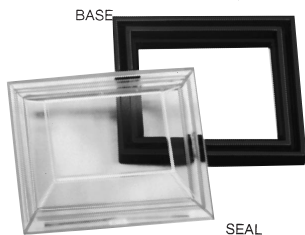
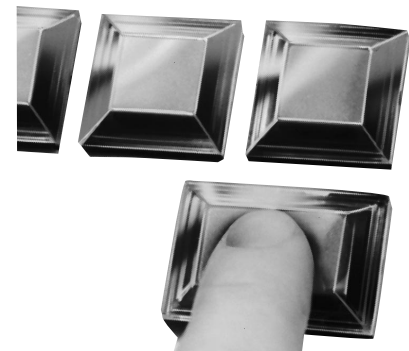

FEATURES

- AML75 panel seals fit pushbutton switches and indicators.
- Provides protection from contamination from accidental beverage spills, dust, and dirt.
- Easy to install, without tools
- No effect on display color, light intensity, or legend quality.
- Replace seal or change lamps without removing switch from panel.
- For .19-inch standard height square or rectangular pushbuttons.
- Mounting dimensions page 53.

The design complements AML's functional appearance, creating a pleasing framed effect around the button. It consists of a matte black plastic base which press-fits between the panel and switch bezel, and a transparent flexible seal which snaps into the base. PK 8521, shipped with each order, provides installation instructions.

Button colors and legends can be viewed without distortion whether lighted or unlighted. Seals can be conveniently replaced or removed for relamping, without removing the switch from panel.

Operating temperature range is 32° to 131°F (0° to 55°C).

AML75 PANEL SEAL ORDER GUIDE

Description	For Use With:		
	Square .19" high pushbuttons	Rectangular .19" high pushbuttons	Rockers
Base & Seal	AML75ABC	AML75BBC	AML75RBC

Notes:

Multiple units should not be mounted in a single slot, since this would create an unsealed space between each unit. AML75 seals are not for use with barriers,

full guard bezels, AML61 mounting hardware, AML45 annunciators, or AML41J, K, or L lens type indicators.



AML76 switch guard protects square and rectangular .19-inch standard height pushbuttons from inadvertent actuation. It is for use with standard bezel type switches only.

AML switch guards may be mounted in horizontal or vertical matrices. A wire lock-down feature, using .020-inch diameter locking wire, may be used as an additional protection.

This connector block can be used with square 1 and 2 pole AML21 and AML22 switches with .110 × .020 terminals to enable plug-in wiring.

See page 53 for mounting dimensions.

AML78 PANEL PLUGS

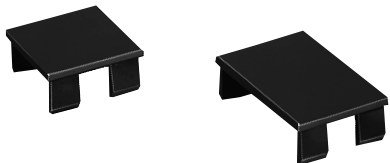

Panel plugs are only for use in individual holes or with AML61 mounting hardware in multi-station strips. (Use dummy housings in strip cutouts without AML61 mounting hardware.)

AML78 DUMMY HOUSINGS

Dummy housings can be used to provide for expansion needs in strip cutouts without AML61 mounting hardware. They have mounting clips, but there is no provision for switching or illumination.

Plastic panel plugs (shown above) enable the user to provide for future needs by punching extra panel holes. Finished in matte black, they are the same height as the standard AML bezel when snapped in place from the panel front.

PANEL PLUG ORDER GUIDE

Plug Type	Catalog Listing
Square	AML78CB
Rectangular	AML78FB

DUMMY HOUSING ORDER GUIDE

Dummy Housing Type*	Catalog Listing
Rectangular (Pushbutton style)	AML78F100
Rectangular (Lens indicator style)	AML78J100

* Order AML51 Buttons/lenses for use with dummy housings.

Installed in These Products	V _f	I _f	V _{PD}	w/o Diode Protection	w/Diode Protection
AML12, 15, 16, 22, 25, 26, 42	2.4 V	20 mA	.7 V	5 V	34 V
AML45	2.4 V	20 mA	.7 V	4 V	33 V

100,000 hours (half life).

AML92 SERIES LEDs



For use with these AML switches and indicators equipped with lamp sockets:

Pushbutton switches: AML11 (Square Only)*, AML21 (rectangular and square), and AML31.

Paddle switches: AML31/23/33

Rocker switches: AML14/24/34

Indicators: AML41

* Rectangular solid state with one or two lamp circuits cannot be used with LED catalog listings ending in "L".

AML92 ORDER GUIDE

LED Color	Quad Chip	Six Chip
Red	AML92ERY	AML92ERL
Green	AML92EGY	AML92EGL
Yellow	AML92EYY	AML92EYL
White	—	AML92EWL**

** For use with white or yellow buttons.

OPERATING CHARACTERISTICS

Type	V _f Fwd. Voltage (typ.)				I _f Fwd. Current	V _R Rev. Voltage
	Yellow	Green	Red	White		
Quad Chip	8.6	8.6	7.8	—	15 mA	16 V
Six Chip	4 V	4 V	4 V	4 V	50 mA	5.6 V

TEMPERATURE RANGE

(Quad Chip or Six Chip)

Operating: -20 to 60°C (-4 to 140°F)

Storage: -30 to 100°C (-22 to 212°F)

of the LED current must be provided. It is recommended that a minimum of 5 VDC open circuit voltage with an appropriate series resistance be used to drive LED devices. This minimizes the effect of temperature (current variation) on forward voltage of the LED.

Resistor values can be determined by supply voltage or current for LED:

$$R_s = \frac{E - V_f}{I_f}$$

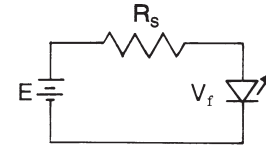

WHERE: R_s = Series Resistance

E = Supply Voltage

V_f = Forward Voltage of LED

I_f = Circuit Current

If a diode is added in series for reverse polarity protection then:

$$R_s = \frac{E - V_f - V_{PD}}{I_f}$$

WHERE: V_{PD} Forward Voltage of Protection Diode

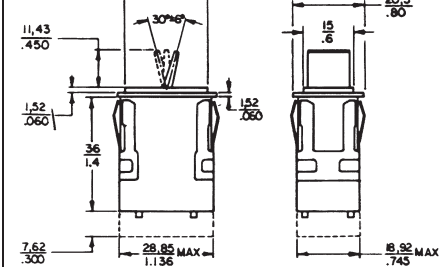
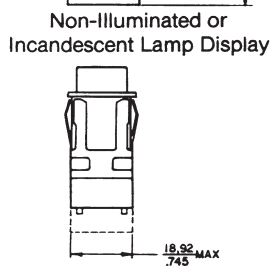
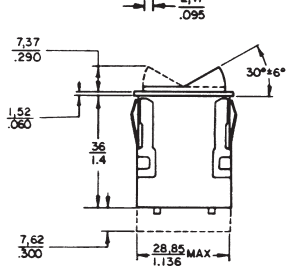

For terminal locations, see page 49/50.

For terminal locations, see page 49/50.

AML41 INDICATOR

LENS STYLE

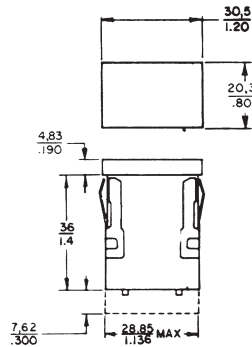

For terminal locations, see page 50.

NOTE

1 Dimensions are **mm** or **mm/IN**

IN

AML42 INDICATOR

MINIATURE

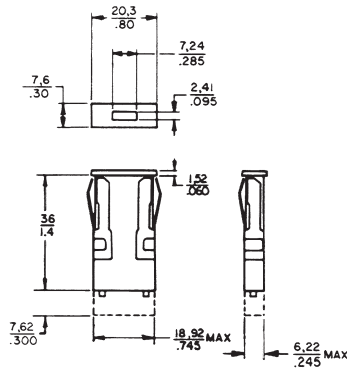

TERMINAL TYPES

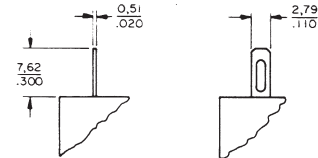

Solder or Quick Connect

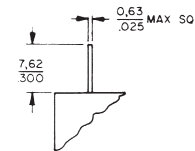

Printed Circuit

Solder Hole will accept two #22 AWG Stranded Conductor (per NEMA publication DC-2 1976)

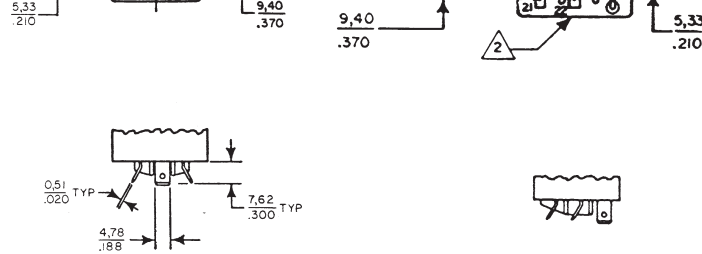
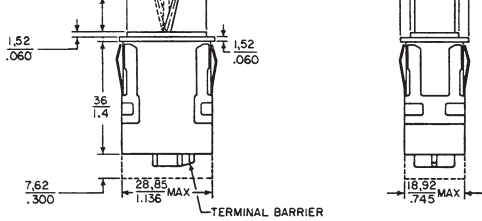

PANEL CUTOUT FOR SINGLE-STATION FRONT-OF-PANEL MOUNTING

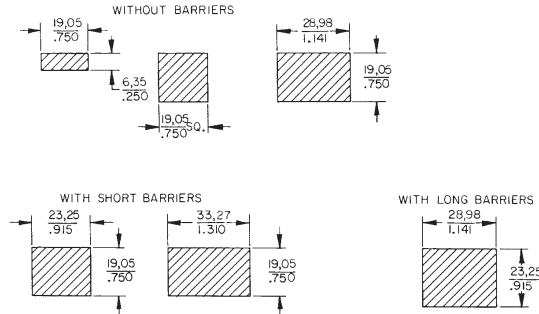

Recommended panel thickness: .060-.187/1,52-4,75

NOTES

1 Dimensions are mm or mm/IN

Manufacturers logo on this side of housing
Solder Hole Will Accept One #14 AWG Stranded Conductor
(Per NEMA Publication DC-2 1976)

PANEL PUNCH FOR AML SERIES

A panel punch is manufactured by Greenlee-Textron Tool Co., Rockford, IL (815-926-3011).

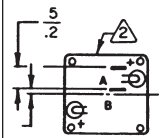

1 Incandescent Lamp Circuit

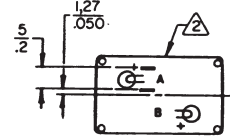

1 Incandescent Lamp Circuit

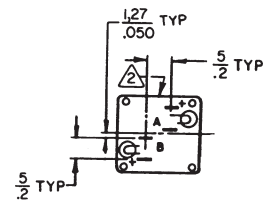

2 Incandescent Lamp Circuits

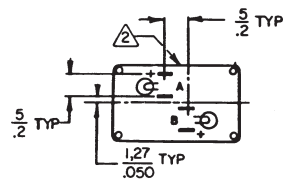

2 Incandescent Lamp Circuits

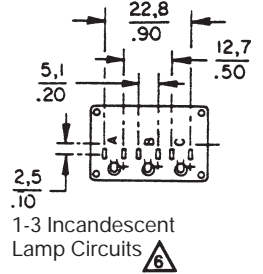

1-3 Incandescent Lamp Circuits **6**

Printed Circuit

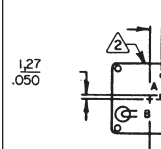

1 Incandescent Lamp Circuit

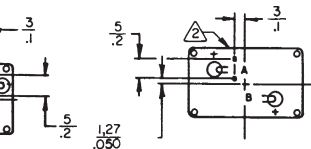

1 Incandescent Lamp Circuit

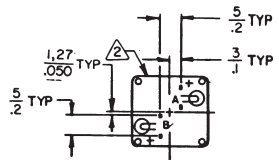

2 Incandescent Lamp Circuits

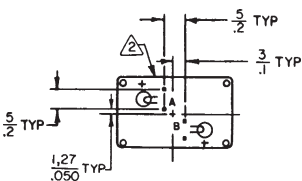

2 Incandescent Lamp Circuits

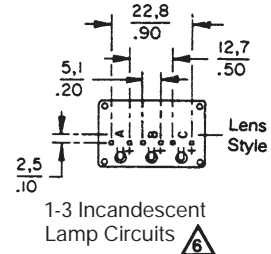

1-3 Incandescent Lamp Circuits **6** Lens Style

TERMINAL LOCATIONS FOR AML42 INDICATORS

Solder and Quick-Connect

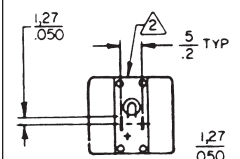

1 LED Circuit

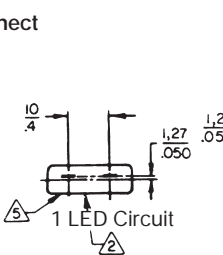

1 LED Circuit

Printed Circuit

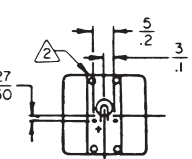

1 LED Circuit

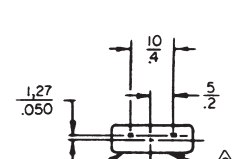

1 LED Circuit

NOTE

- 1 Dimensions are MM or MM/IN
- 2** Manufacturer's logo on this side of housing
- 4 - Lamp terminals are not provided for non-illuminated devices
- 5** positive terminal ident. (+) marked this side of housing
- 6** 1 - lamp termination identified by "B".
2 - lamp termination identified by "A" and "C".

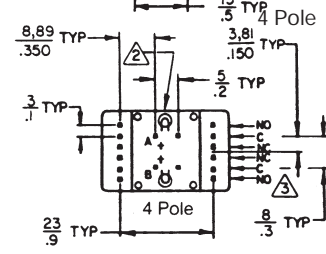
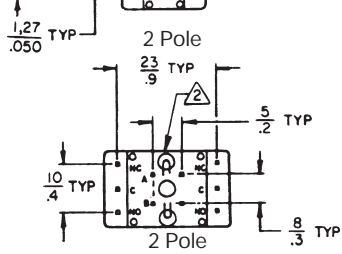
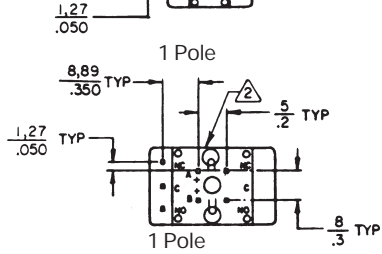

ILLUMINATED ROCKERS AND PADDLES
Solder or Quick-Connect

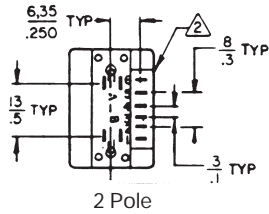
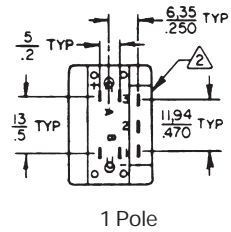

Printed Circuit

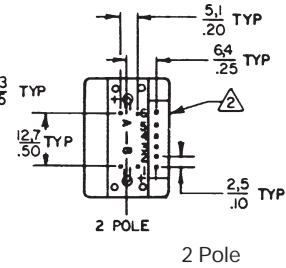
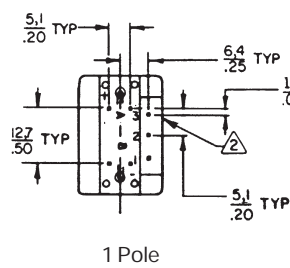

NON-ILLUMINATED ROCKERS AND PADDLES
Solder or Quick-Connect

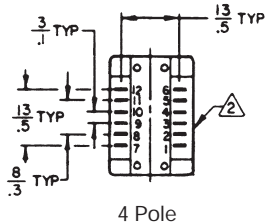
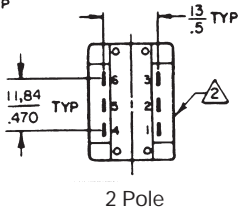
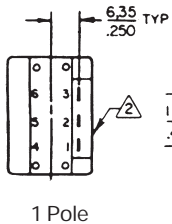

Printed Circuit

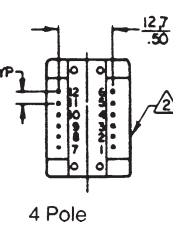
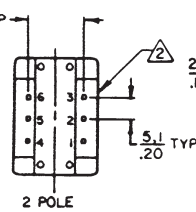
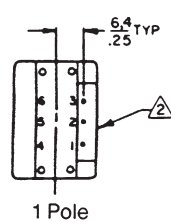

(DO NOT CHAMFER EDGE)

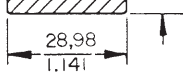

(DO NOT CHAMFER EDGE)

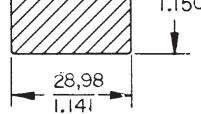

(DO NOT CHAMFER EDGE)



Manufacturer's logo on this side of housing

For panel punch manufacturer, see page 48.

"D" or "E"	in.	on C _L	mm	on C _L
	.807		20,50	
	1.614		41,00	
	2.421		61,49	
	3.228		81,99	
	4.035		102,49	
	4.842		122,99	
	5.649		143,48	
	6.456		163,98	
	7.263		184,48	
	8.070		204,98	
	8.877		225,48	

Tolerance = ±.015

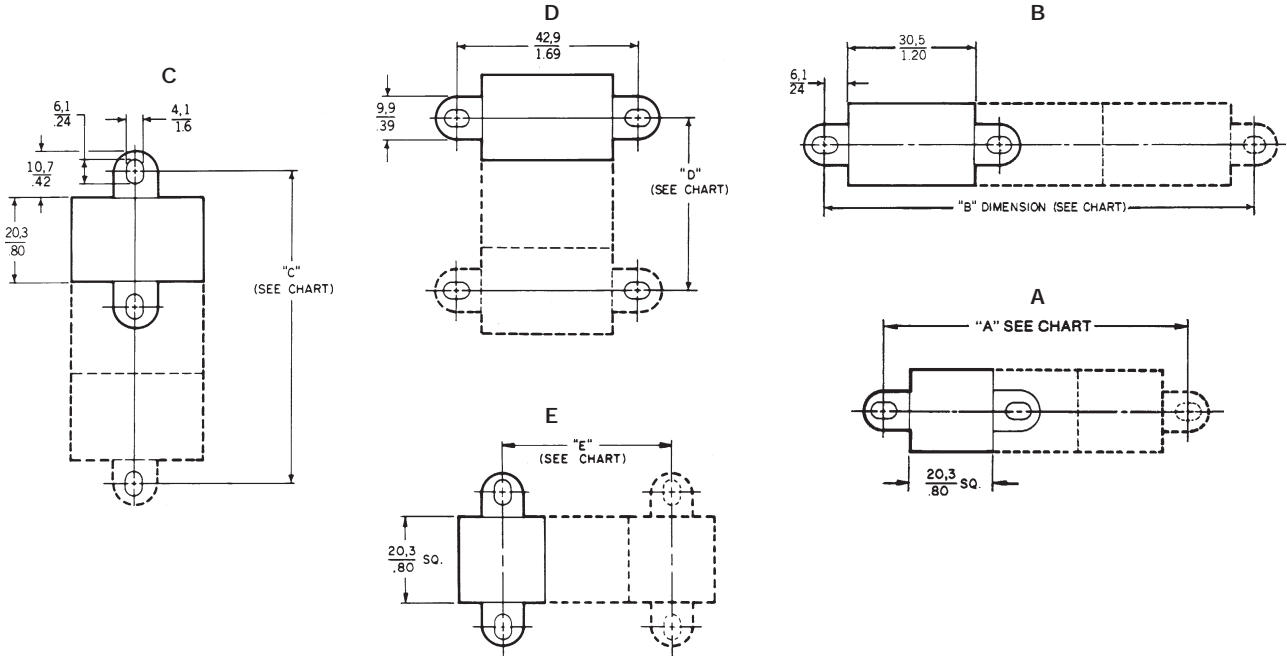

RECOMMENDED
PANEL
THICKNESS:
.060-.187 inch

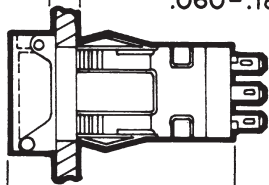

$\frac{8,9}{.350}$ $\frac{35,2}{1.38}$

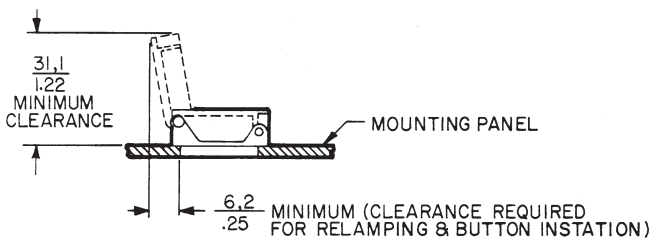
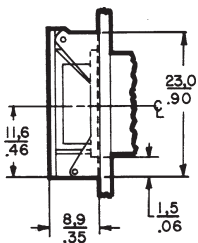

PANEL CUTOUTS

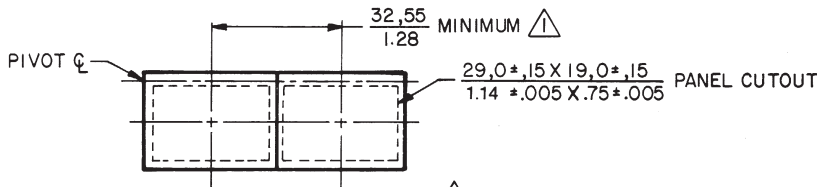
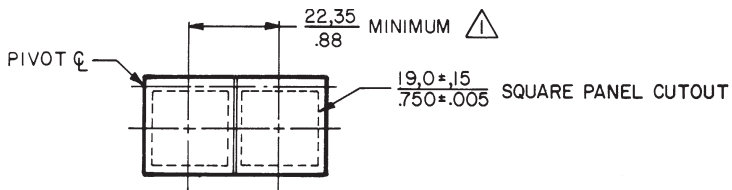

⚠ MINIMUM DIMENSION ALLOWED FOR MOUNTING GUARDS SIDE BY SIDE

X-ON Electronics

Largest Supplier of Electrical and Electronic Components

Click to view similar products for [Pushbutton Switches](#) category:

Click to view products by [Honeywell](#) manufacturer:

Other Similar products are found below :

[LW1L-M1C10V-A](#) [LW2L-A1C20M-GD](#) [LW2L-M1C20M-A](#) [60324L](#) [M7E-HRN2](#) [67021K512](#) [67081K512X](#) [701PB580](#) [719-5504-000](#)
[MDPSSGLFS](#) [810KSV30B](#) [MML23KA3AC05K-001](#) [MML23KW3AA01W](#) [8418K2](#) [8646AB6X718UL](#) [8646ABUL](#) [FSDWH](#) [9001KXRK](#)
[9001T8BK](#) [9533CD4+U574+U4922](#) [1203MRA](#) [A22EM01S](#) [A595](#) [1202A6](#) [12037A2ULCSA](#) [1203A2UL](#) [ABD122N-B](#) [1211390004](#)
[ABN111-Y](#) [1211500044](#) [1211580012](#) [1212MRA](#) [1232A6NF](#) [RA3CSH6A](#) [1241.1183.7047](#) [1241.2511](#) [1241.3428](#) [1223A2ULCSA](#)
[1223MRA](#) [1232AX2119](#) [1241.1183.8000](#) [1241.1183.8029](#) [1241.2506](#) [1241.2606](#) [12MA6](#) [1301940184](#) [RELBARF6X10\(PLASTIC\)](#)
[13435AG](#) [13440AD2G25X822+U4546](#) [13445A4GX768](#)