



# MIC49300

## 3A Low Voltage LDO Regulator with Dual Input Voltages

### General Description

The MIC49300 is a high-bandwidth, low-dropout, 3.0A voltage regulator ideal for powering core voltages of low-power microprocessors. The MIC49300 implements a dual supply configuration allowing for very low output impedance and very fast transient response.

The MIC49300 requires a bias input supply and a main input supply, allowing for ultra-low input voltages on the main supply rail. The input supply operates from 1.4V to 6.5V and the bias supply requires between 3V and 6.5V for proper operation. The MIC49300 offers fixed output voltages from 0.9V to 1.8V and adjustable output voltages down to 0.9V.

The MIC49300 requires a minimum of output capacitance for stability, working optimally with small ceramic capacitors.

The MIC49300 is available in a 5-pin S-Pak. It operates over a junction temperature range of  $-40^{\circ}\text{C}$  to  $+125^{\circ}\text{C}$ .

Datasheets and support documentation are available on Micrel's web site at: [www.micrel.com](http://www.micrel.com).

### Features

- Input voltage range:
  - $V_{IN}$ : 1.4V to 6.5V
  - $V_{BIAS}$ : 3.0V to 6.5V
- Stable with  $1\mu\text{F}$  ceramic capacitor
- $\pm 1\%$  initial tolerance
- Maximum dropout voltage ( $V_{IN}-V_{OUT}$ ) of 500mV over temperature
- Adjustable output voltage down to 0.9V
- Ultra-fast transient response (up to 10MHz bandwidth)
- Excellent line and load regulation specifications
- Logic controlled shutdown option
- Thermal shutdown and current limit protection
- Power S-Pak package
- Junction temperature range of  $-40^{\circ}\text{C}$  to  $+125^{\circ}\text{C}$

### Applications

- Graphics processors
- PC add-in cards
- Microprocessor core voltage supply
- Low voltage digital ICs
- High efficiency linear power supplies
- SMPS post regulators

### Typical Application

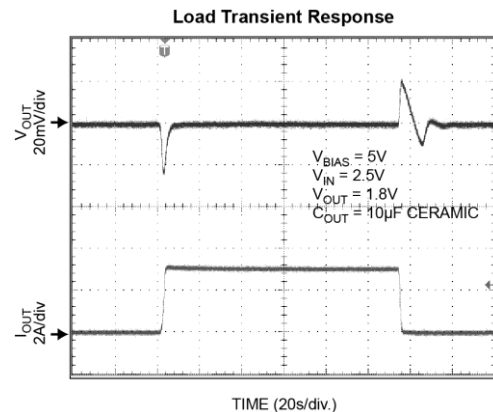
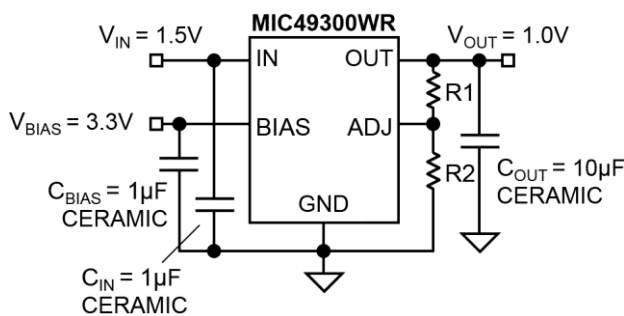

## Ordering Information

Part Number <sup>(1, 2)</sup>	Output Current	Voltage	Temperature Range	Package
MIC49300-0.9WR	3A	0.9V	-40° to +125°C	S-PAK-5
MIC49300-1.2WR	3A	1.2V	-40° to +125°C	S-PAK-5
MIC49300-1.5WR	3A	1.5V	-40° to +125°C	S-PAK-5
MIC49300-1.8WR	3A	1.8V	-40° to +125°C	S-PAK-5
MIC49300WR	3A	Adj.	-40° to +125°C	S-PAK-5

**Note:**

- Other voltages are available. Contact Micrel for details.
- RoHS-compliant with 'high-melting solder' exemption.

## Pin Configuration

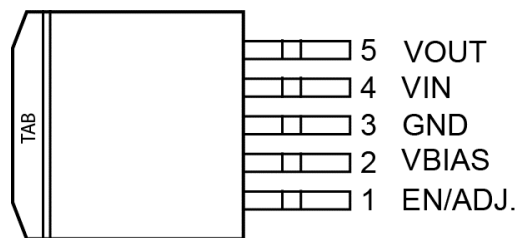

5-Pin S-Pak (R)

## Pin Description

Pin Number	Pin Name	Pin Function
1	EN	Enable (input): CMOS-compatible input. Logic high = enable, logic low = shutdown.
	ADJ	Adjustable regulator feedback input. Connect to resistor voltage divider.
2	VBIAS	Input bias voltage for powering all circuitry on the regulator with the exception of the output power device.
3	GND	Ground (TAB is connected to ground on S-Pak).
4	VIN	Input voltage that supplies current to the output power device.
5	VOUT	Regulator output.

**Absolute Maximum Ratings<sup>(3)</sup>**

Supply Voltage ( $V_{IN}$ )	+8V
Bias Supply Voltage ( $V_{BIAS}$ )	+8V
Enable Input Voltage ( $V_{EN}$ )	+8V
Power Dissipation	Internally Limited
ESD Rating <sup>(5)</sup>	2kV

**Operating Ratings<sup>(4)</sup>**

Supply Voltage ( $V_{IN}$ )	+1.4V to +6.5V
Bias Supply Voltage ( $V_{BIAS}$ )	+3V to +6.5V
Enable Input Voltage ( $V_{EN}$ )	0V to $V_{BIAS}$
Junction Temperature Range	$-40^{\circ}\text{C} \leq T_J \leq +125^{\circ}\text{C}$
Package Thermal Resistance	
S-PAK ( $\theta_{JC}$ )	2°C/W

**Electrical Characteristics<sup>(6)</sup>**

$T_A = 25^{\circ}\text{C}$  with  $V_{BIAS} = V_{OUT} + 2.1\text{V}$ ;  $V_{IN} = V_{OUT} + 1\text{V}$ ; **bold** values indicate  $-40^{\circ}\text{C} \leq T_J \leq +125^{\circ}\text{C}$ , unless noted.

Parameter	Condition	Min.	Typ.	Max.	Units
Output Voltage Accuracy	At 25°C, fixed voltage options Over temperature range	-1		1	%
		<b>-2</b>		<b>2</b>	%
Line Regulation	$V_{IN} = 2.0\text{V to } 6.5\text{V}$	<b>-0.1</b>	0.01	<b>0.1</b>	%/V
Load Regulation	$I_L = 0\text{mA to } 3\text{A}$		0.2	<b>0.5</b>	%
Dropout Voltage ( $V_{IN} - V_{OUT}$ )	$I_L = 1.5\text{A}$		125	<b>200</b>	mV
	$I_L = 3\text{A}$		280	<b>400</b>	mV
Dropout Voltage ( $V_{BIAS} - V_{OUT}$ ), Note 7	$I_L = 3\text{A}$		1.5	<b>2.1</b>	V
Ground Pin Current, Note 8	$I_L = 0\text{mA}$		25		mA
	$I_L = 3\text{A}$		25	<b>50</b>	mA
Ground Pin Current in Shutdown	$V_{EN} \leq 0.6\text{V}$ , ( $I_{BIAS} + I_{CC}$ ), Note 8		0.07	<b>5</b>	$\mu\text{A}$
Current through $V_{BIAS}$	$I_L = 0\text{mA}$		20	<b>35</b>	mA
	$I_L = 3\text{A}$		50	<b>150</b>	mA
Current Limit	$V_{OUT} = 0\text{V}$		6.5	<b>9</b>	A
<b>Enable Input, Note 9</b>					
Enable Input Threshold (fixed voltage only)	Regulator enable	<b>1.6</b>			V
	Regulator shutdown			<b>0.6</b>	V
Enable Pin Input Current			0.1	1.0	$\mu\text{A}$
<b>Reference</b>					
Reference Voltage	Adjustable option only	0.891	0.9	0.909	V
		<b>0.882</b>		<b>0.918</b>	V

**Notes:**

- Exceeding the absolute maximum ratings may damage the device.
- The device is not guaranteed to function outside its operating ratings.
- Devices are ESD sensitive. Handling precautions are recommended. Human body model, 1.5k $\Omega$  in series with 100pF.
- Specification for packaged product only.
- For  $V_{OUT} \leq 1\text{V}$ ,  $V_{BIAS}$  dropout specification does not apply due to a minimum 3V  $V_{BIAS}$  input.
- $I_{GND} = I_{BIAS} + (I_{IN} - I_{OUT})$ . At high loads, input current on  $V_{IN}$  will be less than the output current, due to drive current being supplied by  $V_{BIAS}$ .
- Fixed output voltage versions only.

### Functional Diagram

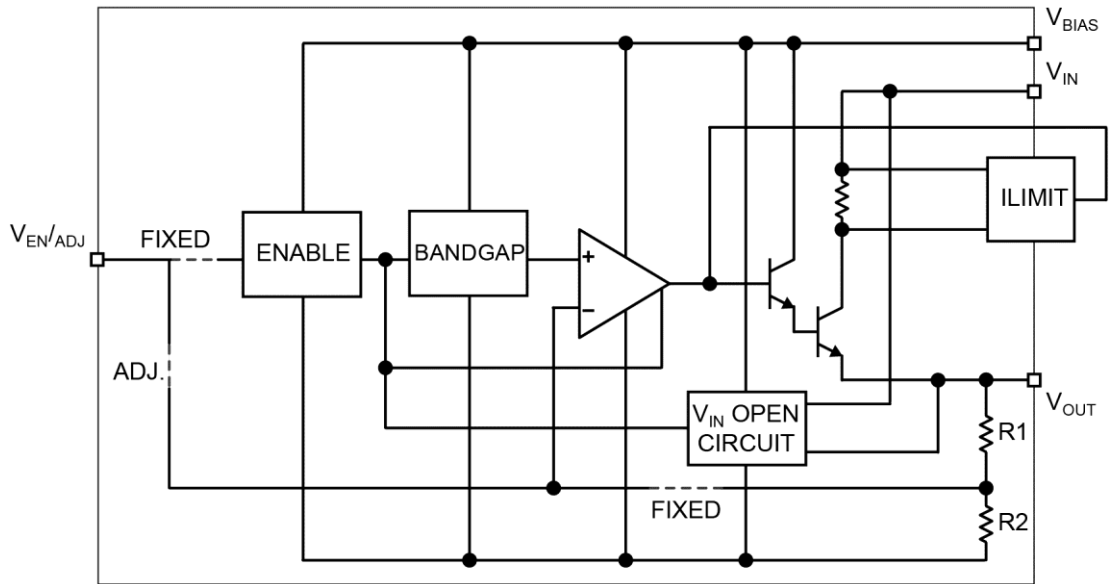

# Typical Characteristics

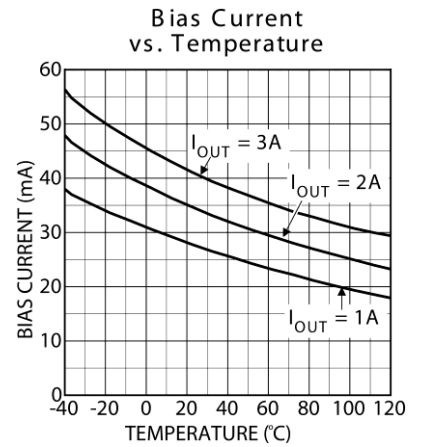
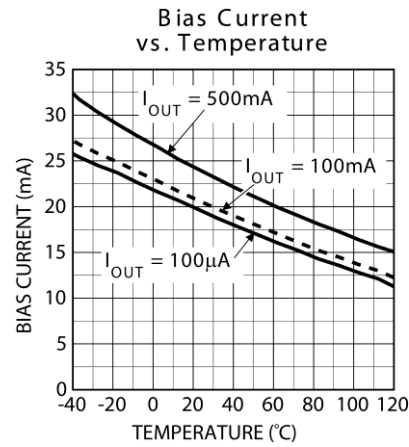
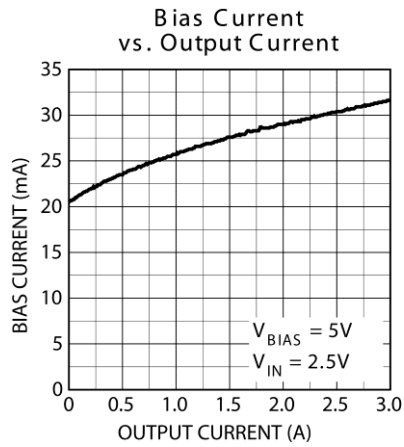
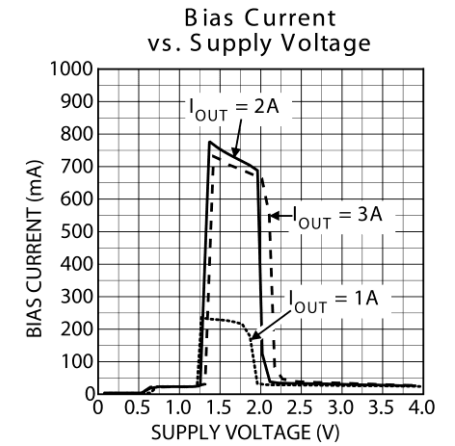
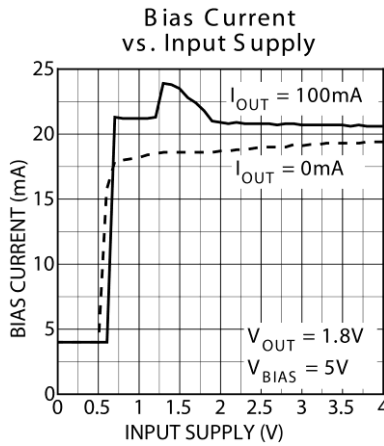
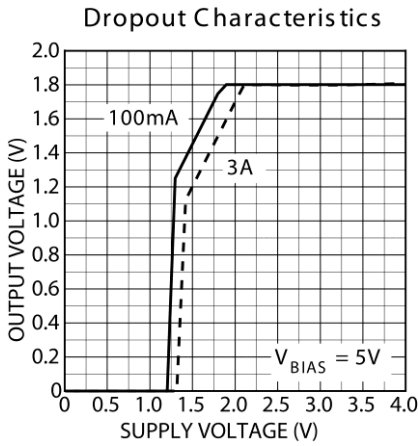
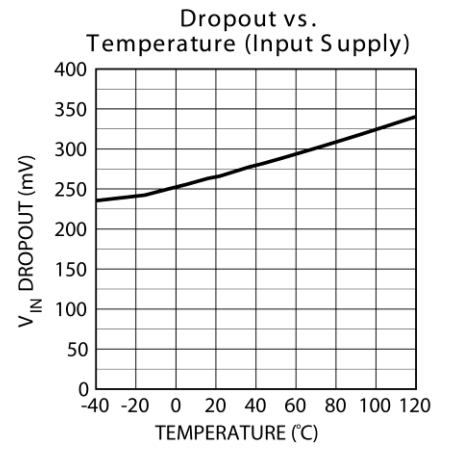
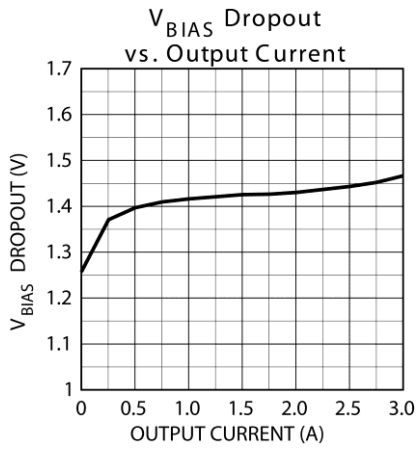
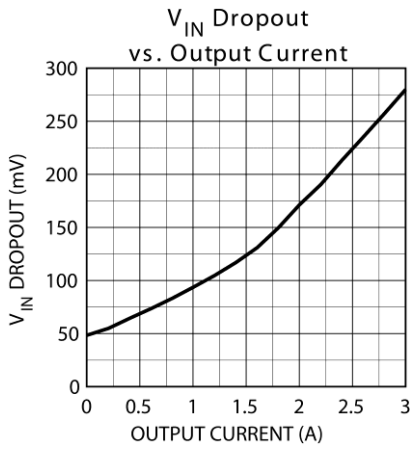

### Typical Characteristics (Continued)

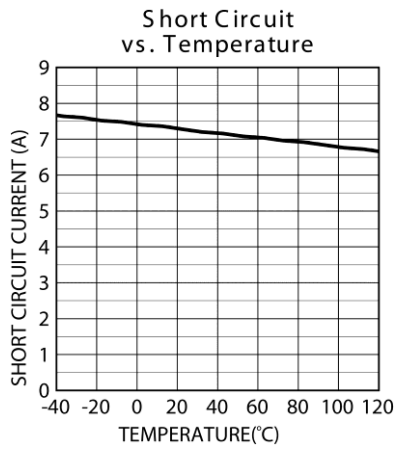
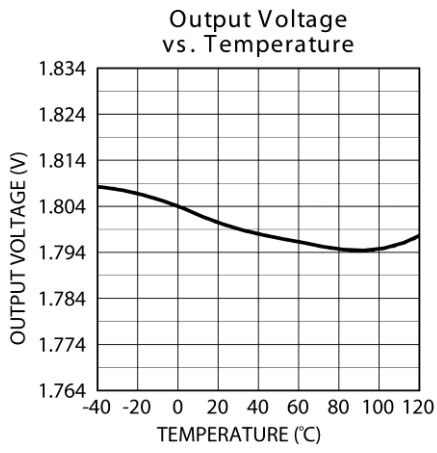

## Applications Information

The MIC49300 is an ultra-high performance, low dropout linear regulator designed for high current applications requiring fast transient response. The MIC49300 utilizes two input supplies, significantly reducing dropout voltage, perfect for low-voltage, DC-to-DC conversion. The MIC49300 requires a minimum of external components and obtains a bandwidth of up to 10MHz. As a  $\mu$ Cap regulator, the output is tolerant of virtually any type of capacitor including ceramic and tantalum.

The MIC49300 regulator is fully protected from damage due to fault conditions, offering linear current limiting and thermal shutdown.

### Bias Supply Voltage

$V_{BIAS}$ , requiring relatively light current, provides power to the control portion of the MIC49300.  $V_{BIAS}$  requires approximately 33mA for a 1.5A load current. Dropout conditions require higher currents. Most of the biasing current is used to supply the base current to the pass transistor. This allows the pass element to be driven into saturation, reducing the dropout to 300mV at a 1.5A load current. Bypassing on the bias pin is recommended to improve performance of the regulator during line and load transients. Small ceramic capacitors from  $V_{BIAS}$  to ground help reduce high frequency noise from being injected into the control circuitry from the bias rail and are good design practice. Good bypass techniques typically include one larger capacitor such as a 1 $\mu$ F ceramic and smaller valued capacitors such as 0.01 $\mu$ F or 0.001 $\mu$ F in parallel with that larger capacitor to decouple the bias supply. The  $V_{BIAS}$  input voltage must be 1.6V above the output voltage with a minimum  $V_{BIAS}$  input voltage of 3V.

### Input Supply Voltage

$V_{IN}$  provides the high current to the collector of the pass transistor. The minimum input voltage is 1.4V, allowing conversion from low voltage supplies.

### Output Capacitor

The MIC49300 requires a minimum of output capacitance to maintain stability. However, proper capacitor selection is important to ensure desired transient response. The MIC49300 is specifically designed to be stable with virtually any capacitance value and ESR. A 1 $\mu$ F ceramic chip capacitor should satisfy most applications. Output capacitance can be increased without bound. See Typical Characteristics for examples of load transient response.

X7R dielectric ceramic capacitors are recommended because of their temperature performance. X7R-type capacitors change capacitance by 15% over their operating temperature range and are the most stable type of ceramic capacitors. Z5U and Y5V dielectric

capacitors change value by as much as 50% and 60%, respectively, over their operating temperature ranges. To use a ceramic chip capacitor with Y5V dielectric, the value must be much higher than an X7R ceramic or a tantalum capacitor to ensure the same capacitance value over the operating temperature range. Tantalum capacitors have a very stable dielectric (10% over their operating temperature range) and can also be used with this device.

### Input Capacitor

An input capacitor of 1 $\mu$ F or greater is recommended when the device is more than 4 inches away from the bulk supply capacitance, or when the supply is a battery. Small, surface-mount, ceramic chip capacitors can be used for the bypassing. The capacitor should be placed within 1" of the device for optimal performance. Larger values will help to improve ripple rejection by bypassing the input to the regulator, further improving the integrity of the output voltage.

### Thermal Design

Linear regulators are simple to use. The most complicated design parameters to consider are thermal characteristics. Thermal design requires the following application-specific parameters:

- Maximum ambient temperature ( $T_A$ )
- Output Current ( $I_{OUT}$ )
- Output Voltage ( $V_{OUT}$ )
- Input Voltage ( $V_{IN}$ )
- Ground Current ( $I_{GND}$ )

First, calculate the power dissipation of the regulator from these numbers and the device parameters from this datasheet.

$$P_D = V_{IN} \times I_{IN} + V_{BIAS} \times I_{BIAS} - V_{OUT} \times I_{OUT}$$

The input current will be less than the output current at high output currents as the load increases. The bias current is a sum of base drive and ground current. Ground current is constant over load current. Then the heat sink thermal resistance is determined with this formula:

$$\theta_{SA} = \left( \frac{T_{J(MAX)} \pm T_A}{P_D - (\theta_{JC} + \theta_{CS})} \right) \quad \text{Equation 1}$$

The heat sink may be significantly reduced in application where the maximum input voltage is known and large compared with the dropout voltage. Use a series input resistor to drop excessive voltage and distribute the heat between this resistor and the regulator. The low dropout

properties of the MIC49300 allow significant reductions in regulator power dissipation and the associated heat sink without compromising performance. When this technique is employed, a capacitor of at least 1 $\mu$ F is needed directly between the input and regulator ground. Refer to Application Note 9 for further details and examples on thermal design and heat sink specification.

#### Minimum Load Current

The MIC49300, unlike most other high current regulators, does not require a minimum load to maintain output voltage regulation.

#### Power Sequencing

There is no power sequencing requirement for  $V_{IN}$  and  $V_{BIAS}$  giving more flexibility to the user.

#### Adjustable Regulator Design

The MIC49300 adjustable version allows programming the output voltage anywhere between 0.9V and 5V. Two resistors are used. The resistor value between  $V_{OUT}$  and

the adjust pin should not exceed 1k $\Omega$ . Larger values can cause instability. The resistor values are calculated by:

$$R1 = R2 \times \left( \frac{V_{OUT}}{0.9} - 1 \right) \quad \text{Equation 2}$$

Where  $V_{OUT}$  is the desired output voltage.

#### Enable

The fixed output voltage versions of the MIC49300 feature an active high enable input (EN) that allows on-off control of the regulator. Current drain reduces to “zero” when the device is shut down, with only microamperes of leakage current. The EN input has TTL/CMOS compatible thresholds for simple logic interfacing. EN may be directly tied to  $V_{IN}$  and pulled up to the maximum supply voltage.



Package Information<sup>(10)</sup>

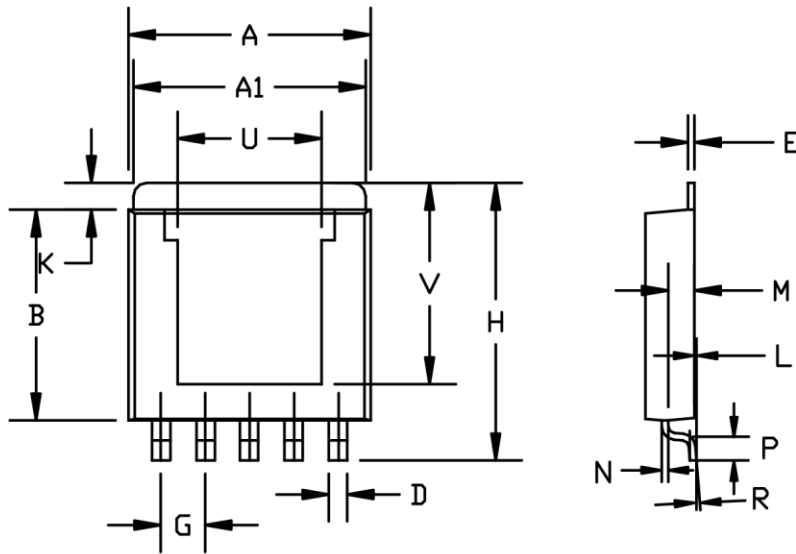

	INCHES		MILLIMETERS	
A	0.365	0.375	9.27	9.52
A1	0.350	0.360	8.89	9.14
B	0.310	0.320	7.87	8.13
C	0.070	0.080	1.78	2.03
D	0.025	0.031	0.63	0.79
E	0.010	BSC	0.25	BSC
G	0.067	BSC	1.70	BSC
H	0.410	0.420	10.41	10.67
K	0.030	0.050	0.76	1.27
L	0.001	0.005	0.03	0.13
M	0.035	0.045	0.89	1.14
N	0.010	BSC	0.25	BSC
P	0.031	0.041	0.79	1.04
R	0°	6°	0°	6°
U	0.220	BSC	5.58	BSC
V	0.296	BSC	7.52	BSC

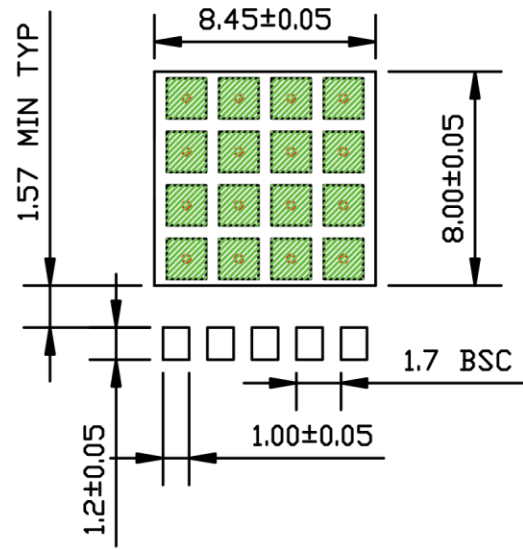
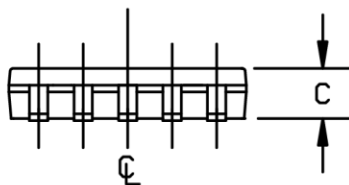

- NOTE:
1. DIMENSION DOES NOT INCLUDE MOLD FLASH OR PROTRUSIONS.
  2. DIMENSION INCLUDES PLATING THICKNESS. SOLDER MASK OPENING
  3. RED CIRCLES IN LAND PATTERN REPRESENT THERMAL VIA, 0.30MM IN DIAMETER & SHOULD BE CONNECTED TO GND FOR MAXIMUM PERFORMANCE
  4. GREEN RECTANGLES IN LAND PATTERN REPRESENT SOLDER STENCIL OPENING (OPTIONAL), 1.50X1.50MM.

**RECOMMENDED  
LAND PATTERN**

5-Pin S-Pak (R)

Note:

10. Package information is correct as of the publication date. For updates and most current information, go to [www.micrel.com](http://www.micrel.com).

---

**MICREL, INC. 2180 FORTUNE DRIVE SAN JOSE, CA 95131 USA**TEL +1 (408) 944-0800 FAX +1 (408) 474-1000 WEB <http://www.micrel.com>

Micrel makes no representations or warranties with respect to the accuracy or completeness of the information furnished in this data sheet. This information is not intended as a warranty and Micrel does not assume responsibility for its use. Micrel reserves the right to change circuitry, specifications and descriptions at any time without notice. No license, whether express, implied, arising by estoppel or otherwise, to any intellectual property rights is granted by this document. Except as provided in Micrel's terms and conditions of sale for such products, Micrel assumes no liability whatsoever, and Micrel disclaims any express or implied warranty relating to the sale and/or use of Micrel products including liability or warranties relating to fitness for a particular purpose, merchantability, or infringement of any patent, copyright or other intellectual property right.

Micrel Products are not designed or authorized for use as components in life support appliances, devices or systems where malfunction of a product can reasonably be expected to result in personal injury. Life support devices or systems are devices or systems that (a) are intended for surgical implant into the body or (b) support or sustain life, and whose failure to perform can be reasonably expected to result in a significant injury to the user. A Purchaser's use or sale of Micrel Products for use in life support appliances, devices or systems is a Purchaser's own risk and Purchaser agrees to fully indemnify Micrel for any damages resulting from such use or sale.

© 2014 Micrel, Incorporated.

## X-ON Electronics

Largest Supplier of Electrical and Electronic Components

*Click to view similar products for [LDO Voltage Regulators](#) category:*

*Click to view products by [Microchip](#) manufacturer:*

Other Similar products are found below :

[M38D29FFHP#U1](#) [702103A](#) [717726C](#) [742457H](#) [MP20051DN-LF-Z](#) [R5F111PGGFB#30](#) [AP7363-SP-13](#) [NCP103AMX285TCG](#)  
[NCV8664CST33T3G](#) [NCV8752AMX28TCG](#) [L9454](#) [AP7362-HA-7](#) [LX13043CLD](#) [TCR3DF185,LM\(CT](#) [TCR3DF24,LM\(CT](#)  
[TCR3DF285,LM\(CT](#) [TCR3DF31,LM\(CT](#) [TCR3DF45,LM\(CT](#) [TLF4949EJ](#) [L9708](#) [L970813TR](#) [030014BB](#) [059985X](#) [NCP121AMX173TCG](#)  
[NCP4687DH15T1G](#) [NCV8703MX30TCG](#) [701326R](#) [702087BB](#) [755078E](#) [TCR2EN28,LF\(S](#) [LM1117DT-1.8/NO](#) [LT1086CM#TRPBF](#)  
[AZ1085S2-1.5TRE1](#) [MAX15101EWL+T](#) [NCV8170AXV250T2G](#) [SCD337BTG](#) [TCR3DF27,LM\(CT](#) [TCR3DF19,LM\(CT](#)  
[TCR3DF125,LM\(CT](#) [TCR2EN18,LF\(S](#) [MAX15103EWL+T](#) [TS2937CZ-5.0 C0](#) [MAX8878EUK30-T](#) [MAX663CPA](#) [NCV4269CPD50R2G](#)  
[NCV8716MT30TBG](#) [AZ1117IH-1.2TRG1](#) [MP2013GQ-P](#) [AP2112R5A-3.3TRG1](#) [AP7315-25W5-7](#)