

TMMH-125-04-L-DV-EP

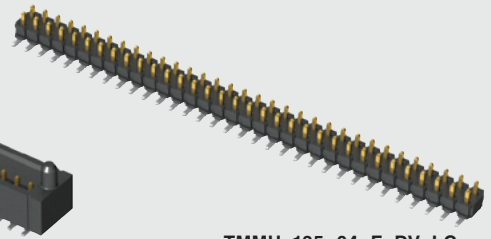

TMMH-135-04-F-DV-LC

(2.00 mm) .0787"

FLEXIBLE SMT HEADER

SPECIFICATIONS

For complete specifications and recommended PCB layouts see www.samtec.com/TMMH

Insulator Material:
Black Liquid Crystal Polymer
Terminal Material:
Phosphor Bronze
Plating:
Sn or Au over
50 μ" (1.27 μm) Ni
Current Rating (TMMH/ESQT):
4.5 A per pin
(2 pins powered)
Current Rating (TMMH/SQT):
5.1 A per pin
(2 pins powered)
Operating Temp Range:
-55 °C to +105 °C with Tin;
-55 °C to +125 °C with Gold
Voltage Rating:
281 VAC mated with SQW;
250 VAC mated with SQT
RoHS Compliant:
Yes

PROCESSING

Lead-Free Solderable:
Yes
SMT Lead Coplanarity:
(0.10 mm) .004" max

RECOGNITIONS

For complete scope of recognitions see www.samtec.com/quality



Board Mates:
CLT, SQT, SQW, ESQT,
TLE, SMM, MMS

Cable Mates:
TCSD

OPTIONS

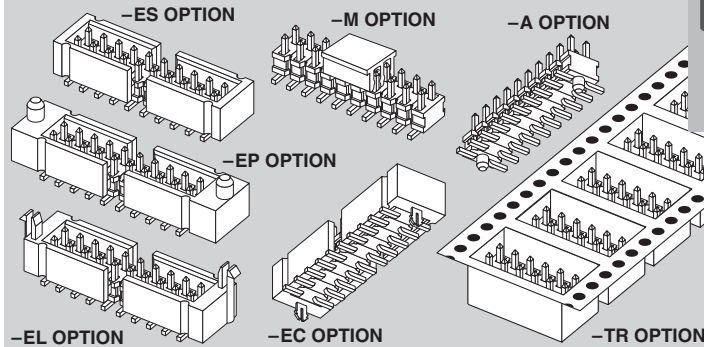

FLEX SHROUD

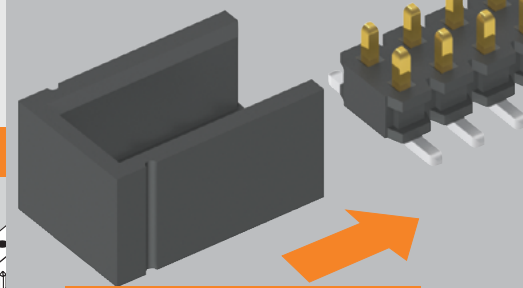

OTHER SOLUTIONS

Through-hole

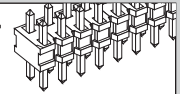

2 mm Shunt

Specify 2SN-BK-G for 2 mm shunt with Gold plating.

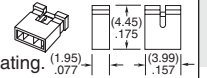

TMMH

1

NO. PINS PER ROW

LEAD STYLE

PLATING OPTION

03 thru 50

Specify LEAD STYLE from chart

-F = Gold flash on post, Matte Tin on tail

-L = 10 μ" (0.25 μm) Gold on post, Matte Tin on tail

-T = Matte Tin

| OPTION | Z |
|------------|----------------|
| -ES | (2.92) .115 |
| -EC | (4.70) .185 |
| -EP & -EPC | (6.10) .240 |
| -EL & -EBC | (4.45) .175 |

| LEAD STYLE | A | MATES WITH |
|------------|----------------|-------------------------------------|
| -01 | (3.20) .126 | SQT, SQW, ESQT, TLE, SMM, MMS, TCSD |
| -04 | (1.91) .075 | CLT |
| -05 | (1.65) .065 | |

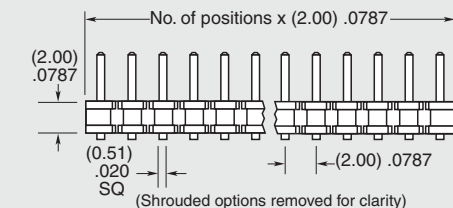
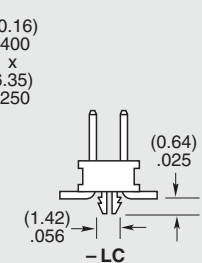
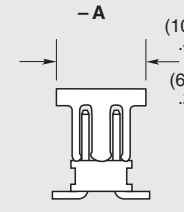
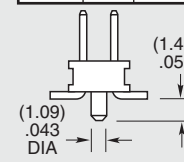
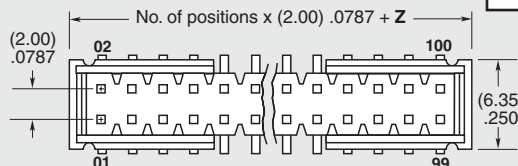

ALSO AVAILABLE (MOQ Required)

- Other platings

Note:
Some lengths, styles and options are non-standard, non-returnable.

Due to technical progress, all designs, specifications and components are subject to change without notice.

WWW.SAMTEC.COM

All parts within this catalog are built to Samtec's specifications. Customer specific requirements must be approved by Samtec and identified in a Samtec customer-specific drawing to apply.

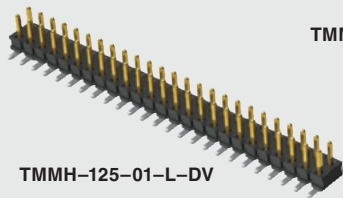

TMMH-110-01-F-DV-A

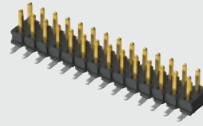
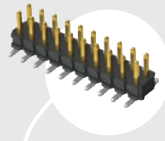

TMMH-114-04-L-DV

TMMH-118-04-F-DV-EL

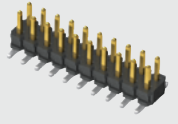

TMMH-110-01-F-DV

TMMH SERIES

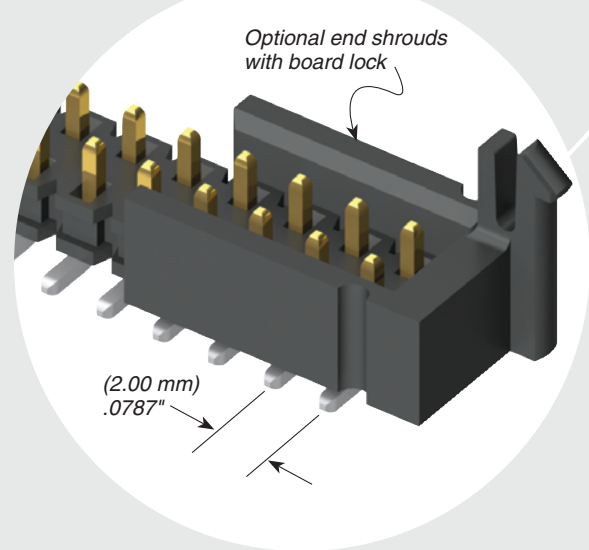
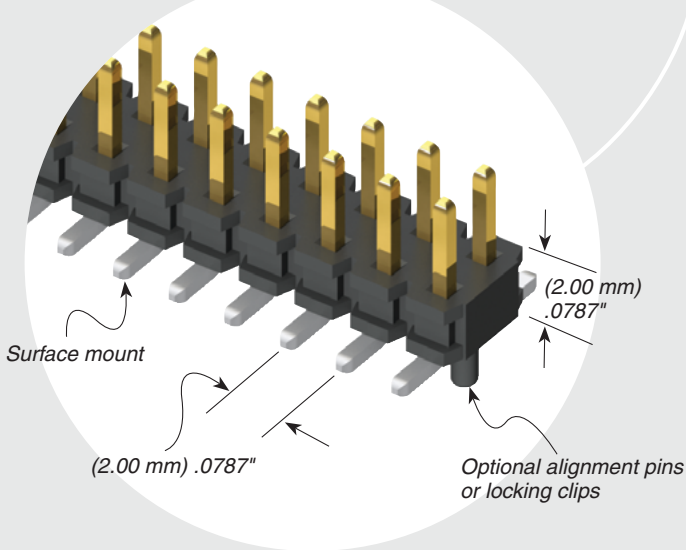

DV

FLEX SHROUD OPTIONS

OTHER OPTIONS

All Flex Shroud options require 9 pins/row minimum (For board-to-board interfaces. Will not mate with TCSD)

-ES

= End Shroud
(For best cost also see TSH Series)

-EC

= End Shroud with Locking Clip
(For best cost also see TSH Series)
(Manual placement required)

-EP

= End Shroud with Guide Post

-EL

= End Shroud with Board Lock
(Boards are positively locked and cannot be unmated)

-EBC

= End Shroud with Board Lock and Locking Clip
(Boards are positively locked and cannot be unmated)

-EPC

= End Shroud with Guide Post and Locking Clip
(Manual placement required)

–“XXX”
= Polarized Position. Specify position of omitted pin

-A

= Alignment Pin
(3 positions minimum)
(Not available with -LC)

-LC

= Locking Clip
(5 positions minimum)
(Not available with -A)
(Manual placement required)

-M

= Pick & Place Pad
(5 positions minimum)

-TR

= Tape & Reel Packaging
(36 positions maximum)
(Flex Shroud options not available except -ES, -EP & -EL)

| LEAD STYLE | X | Y |
|------------|----------------|----------------|
| -01 | (5.84) .230 | (4.45) .175 |
| -04 & -05 | (4.50) .177 | (3.02) .119 |

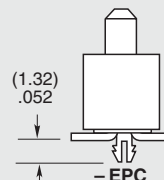
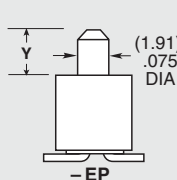
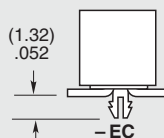
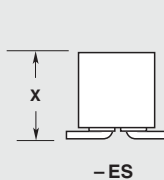
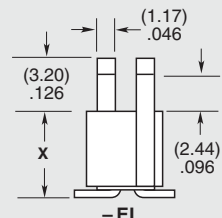
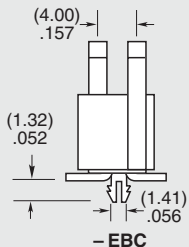

Due to technical progress, all designs, specifications and components are subject to change without notice.

WWW.SAMTEC.COM

All parts within this catalog are built to Samtec's specifications. Customer specific requirements must be approved by Samtec and identified in a Samtec customer-specific drawing to apply.

X-ON Electronics

Largest Supplier of Electrical and Electronic Components

Click to view similar products for [Headers & Wire Housings](#) category:

Click to view products by [Samtec](#) manufacturer:

Other Similar products are found below :

[95000-104TRLF](#) [10135584-644402LF](#) [DF62W-EP2022PCA](#) [95000-106TRLF](#) [DF62W-2022SCA](#) [DF62W-EP2022PC](#) [2203348](#) [DF62W-2022SC](#) [1084018](#) [1029039](#) [1084017](#) [802-10-012-10-002000](#) [1112640](#) [1112639](#) [000-34000](#) [0009482033](#) [0009507031](#) [57102-S06-03LF](#) [57202-S52-04LF](#) [PCN6-15S-2.5E](#) [0039019024](#) [58102-G61-06LF](#) [582553-1](#) [0009485154](#) [0009508121](#) [0022285053](#) [0050291907](#) [018731A](#) [LY20-4P-DT1-P1E-BR](#) [02.125.8002.8](#) [60101931](#) [60598-1 \(Cut Strip\)](#) [M1625-3R/100](#) [61062-3](#) [61082-181009](#) [636-1427](#) [638009-1](#) [641938-9](#) [641991-4](#) [644168-1](#) [647662-1](#) [65039-019ELF](#) [65781-047](#) [65817-002LF](#) [65817-015LF](#) [65863-015LF](#) [66207-023LF](#) [67016-026LF](#) [67046-001LF](#) [67095-007LF](#)