

3M™ Textool™ Laser Diode Sockets



- Compact miniature socket size for maximum board density
- Accomodates most any TO package format with pin circle options of .079" (2.0 mm) or .100" (2.54 mm), including popular laser diode devices
- 3 and 4 lead options available
- Funneled entry holes to assist lead insertion

Date Modified: September 17, 2012

TS-0406-B
Sheet 1 of 3

Insulation

Material: Glass Filled Polysulfone

Flammability: UL 94V-0

Color: Green

Outer Contact:

Material: Copper Alloy

Inner Contact:

Material: Beryllium Copper

Plating: Outer Sleeve: SnPb Solder

Inner Contact: 30 μ" (0.76 μm) Gold over 50 μ" (1.3 μm) Nickel

Current Rating: 1 Amp

Insulation Resistance: $> 1 \times 10^{12} \Omega$ at 500 Vdc

Withstanding Voltage: 1000 Vrms at Sea Level

Temperature Rating: -55°C to +125°C



3M™ Textool™ Laser Diode Sockets

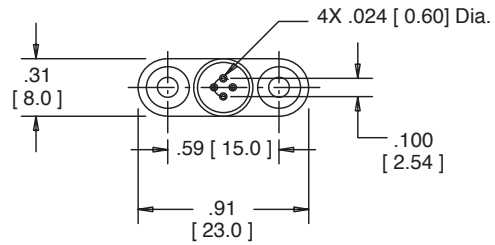
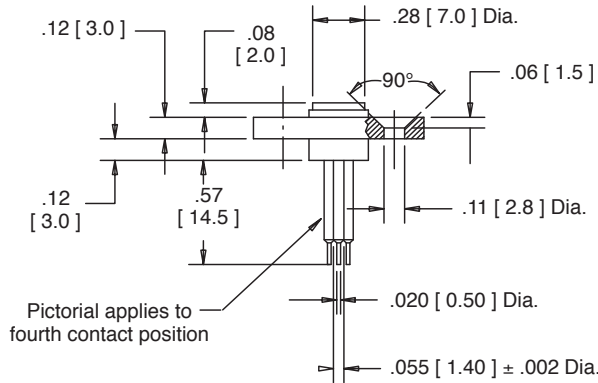

204-6585-00-0602J

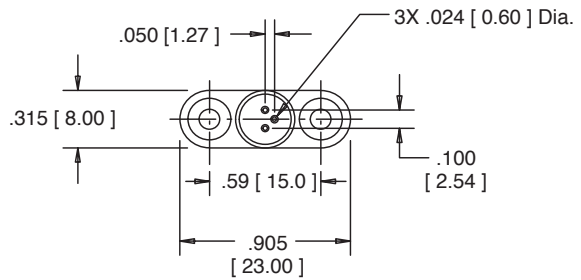

203-6585-00-0602J

	Tolerance $\frac{\text{inch}}{\text{mm}}$	
Dimension	.00 (.0)	.000 (.00)
Tolerance	±.010 (±.25)	±.005 (±.13)

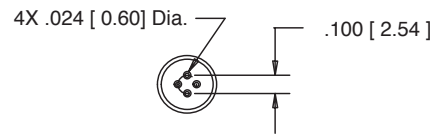
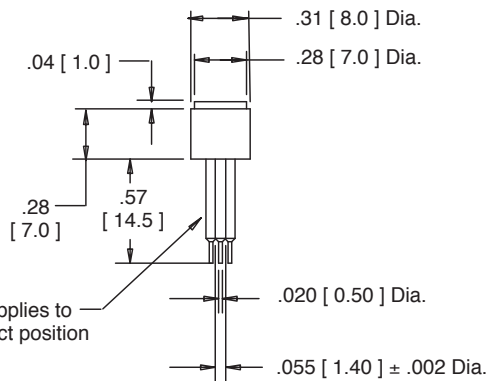

204-6585-50-0602J

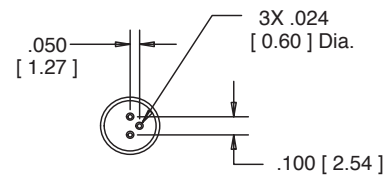

203-6585-50-0602J

Ordering Information

Socket Part Number	Contact Quantity	Pin Circle	Mounting Flange
203-6585-00-0602J	3	.100 [2.54]	Yes
203-6585-50-0602J			No
203-6970-00-0602J		.079 [2.0]	Yes
203-6970-50-0602J			No
204-6585-00-0602J	4	.100 [2.54]	Yes
204-6585-50-0602J			No
204-6970-00-0602J		.079 [2.0]	Yes
204-6970-50-0602J			No

TS-0406-B
Sheet 2 of 3

3M™ Textool™ Laser Diode Sockets

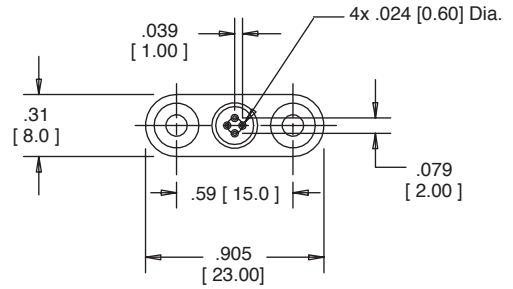
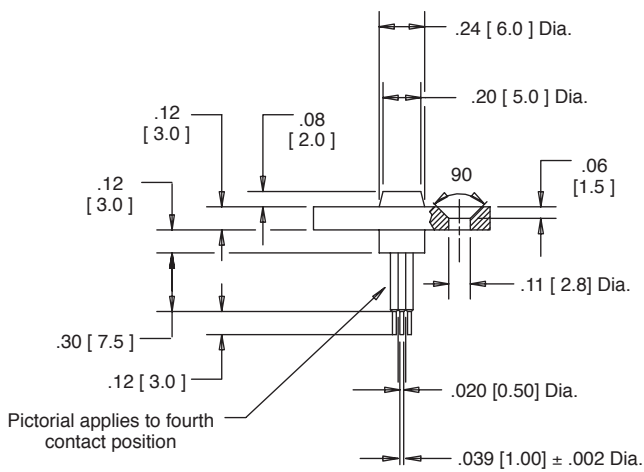

204-6970-00-0602J

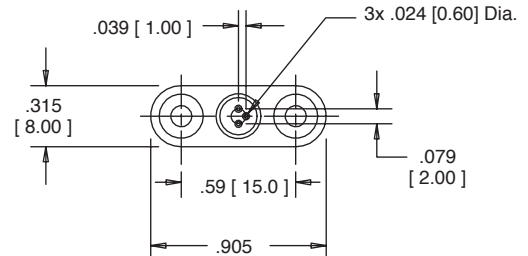

Dimension	Tolerance $\frac{\text{inch}}{\text{mm}}$	
	.00 (.0)	.000 (.00)
Tolerance	±.010 (±.25)	±.005 (±.13)

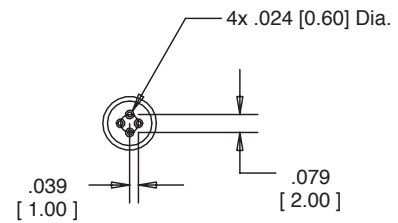
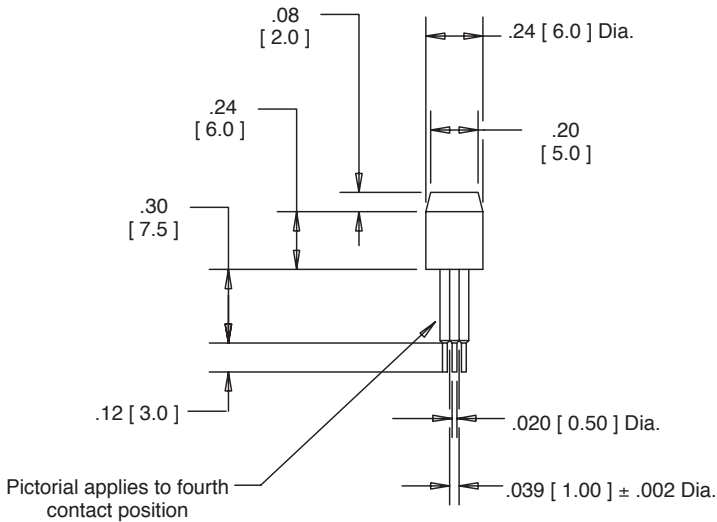

204-6970-50-0602J

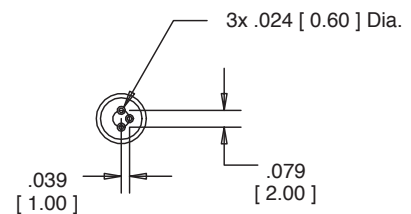

203-6970-50-0602J

Important Notice

All statements, technical information, and recommendations related to 3M's products are based on information believed to be reliable, but the accuracy or completeness is not guaranteed. Before using this product, you must evaluate it and determine if it is suitable for your intended application. You assume all risks and liability associated with such use. Any statements related to the product which are not contained in 3M's current publications, or any contrary statements contained on your purchase order shall have no force or effect unless expressly agreed upon, in writing, by an authorized officer of 3M.

Warranty; Limited Remedy; Limited Liability.

This product will be free from defects in material and manufacture for a period of one (1) year from the time of purchase. **3M MAKES NO OTHER WARRANTIES INCLUDING, BUT NOT LIMITED TO, ANY IMPLIED WARRANTY OF MERCHANTABILITY OR FITNESS FOR A PARTICULAR PURPOSE.** If this product is defective within the warranty period stated above, your exclusive remedy shall be, at 3M's option, to replace or repair the 3M product or refund the purchase price of the 3M product. **Except where prohibited by law, 3M will not be liable for any indirect, special, incidental or consequential loss or damage arising from this 3M product, regardless of the legal theory asserted.**

**3M Electronics Solutions Division**

6801 River Place Blvd.
Austin, TX 78726-9000
U.S.A.
1-800-225-5373
www.3Mconnectors.com

Please recycle. Printed in USA.
© 3M 2012. All rights reserved.
RIA-2217B-E

3M and Textool are trademarks of 3M Company.