

Terminals, Kits and Tools

Glossary of Terminals and Tools Terms	48		
Ring Tongues	53		
Multi-Stud Ring Tongues	78		
Standard Forks	79		
Block Forks	85		
Flanged Block Forks	93		
Locking Forks	98		
Butt Connectors	107	Parallel Connectors	133
Female Disconnects	113	Pin Terminals	134
Male Disconnects	121	3M Highland™ Bagged Terminals	135
Flags	125	Kits	142
Multi-Stack Disconnects	125	Tools	143
Adapters	126	Terminal Stud Size Chart	146
High Temperature	128	American Wire Gauge	146
Closed End Connectors	131		



For more than 30 years, 3M has been a leading supplier of Scotchlok terminals, disconnects, connectors and tools for high performance use in the assembly and maintenance of electrical systems. Thousands of satisfied customers know our products for:

- Effective and reliable performance, UL Listed and CSA Certified where appropriate.
- Variety of types, sizes and materials meeting a broad application range, including the demands of temperature and weather.

- Design features assuring easy installation of 3M products—positive and easy wire insertion, elimination of strand hang-ups and wire twisting, and easy insulation entry.

These are a few of the characteristics that make the installer's job easier.

FREQUENTLY ASKED QUESTIONS

What does the insulation grip do?

The insulation grip provides a “second” crimp on the wire insulation providing additional wire strain relief. It’s excellent for high vibration applications.

Which 3M tools can I use with 3M terminals?

The handy reference guide on pages 143-144 gives you a variety of choices of tools to use with 3M terminals.

What’s the difference between insulated and fully insulated disconnects?

Insulated disconnects have barrel insulation only and fully insulated disconnects are insulated from the barrel to the receptacle/tab.

What temperatures do 3M terminals withstand?

Non-insulated 3M terminals withstand temperatures up to 347°F (175°C). Insulated 3M terminals withstand temperatures up to 221°F (105°C).

Glossary of Terminals and Tools Terms

ADAPTERS

To interconnect two connectors already attached to wires.

BLOCK FORK

Same strength as the fork, but designed to use in terminal block because sides lie flat against barrier portion of terminal block.

BULLET STYLE

Similar advantages as disconnects. Gives reliable in-line connection because parts are made to have holding friction when joined. Usually for automotive use.

BUTT

Uses chamfered barrel ends to provide fast, easy wire insertion from both ends and a built-in wire stop for correct positioning. Must be crimped at both ends.

CLOSED-END

Used in situations requiring pigtail of two or more wires.

FLANGED FORK

Gives the benefit of both the block and locking forks. Stays secure should screw loosen.

FORK

Allows rapid connection of wire. Usually used on free-standing studs, because of wider tongues.

LOCKING FORK

The spring-like tongue locks in place around the stud even when mount screw is not tightened. Extra force is required to remove from stud.

PARALLEL

Similar to butt with overlapped wires and single crimp in center of connector. Used where space is limited.

PINS

For installation in compression blocks. Used in Europe for terminating stranded wire.

QUICK CONNECT (DISCONNECT)

Attached to mating part by tongue of female part slipping over male tab. Use of dents and rolled edges on female part provides excellent holding force while allowing easy and quick disconnect.

RING

The standard style of tongue. The safest and most reliable. It cannot be removed unless mounting screw is removed.

TAB

Uses mounting hole for rivet or screw.

TAP

No wire stripping is necessary, just lay wire in connector and crimp. Connection is made.

Standard Terminal Construction

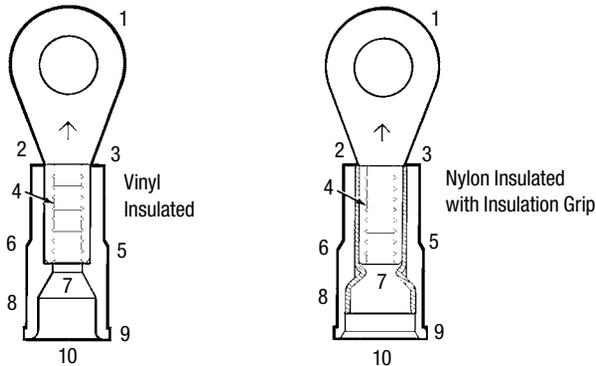

3M™ Terminals provide a variety of design features assuring consistently effective, reliable performance and easy installation.

Please refer to the illustrations at the numbered locations for the attributes described below.

1. One-piece, burr-free construction provides maximum electrical conductivity. Electrical bright-tin plating gives maximum corrosion resistance. Annealing relieves stress points and assures maximum installed strength.
2. Barrel-to-pad transition design minimizes flexing and bending.
3. Open-end design permits visual inspection of wire location before and after crimping.
4. Maximum hold on wire comes from multiple “V” grooves in #26–4 AWG parts resulting in excellent holding power.
5. Injection molded insulations on terminals are the highest quality in the industry.
 - 221°F (105°C) rated, tough, resistant electrical grade materials
 - Molding ensures consistent wall thickness for maximum reliability after crimping
 - Molding allows funnel barrel construction for easier installation
 - Molding offers the crimp ridge and non-slip ridge
6. Crimp ridge designed for positive location of tool on terminal barrel, resulting in few miscrimps.
7. Funnel barrel construction provides:
 - Positive, easy wire insertion
 - No hang-ups of wire strands
 - Wire twisting not necessary

8. Nylon-insulated terminals with grip feature a brass sleeve. Sleeve provides optimum grip on insulation, strain relief and vibration protection. Brass sleeve is recessed which provides excellent flash-over protection.

9. Non-slip ridge so tool slides to correct position for a proper crimp and better workmanship.

10. Beveled leading edge for easy wire insulation entry.

Barrel Styles

Non-Insulated Butted Seam

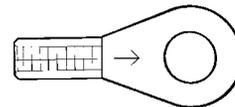

The most economical terminal—used where special performance or installation characteristics are not needed. Beveled mouth facilitates wire insertion. Maximum temperature for bare terminals: 347°F (175°C).

Non-Insulated Brazed Seam

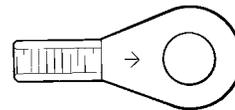

Beveled mouth facilitates wire insertion. Can be crimped anywhere on barrel surface. Silver brazed seam will not open under crimping pressure or operating stresses. Unlike butted seam parts, stranded wire cannot escape barrel confines during or after crimping. Maximum temperature for bare terminals: 347°F (175°C).

Vinyl Insulated Brazed and Butted Seams

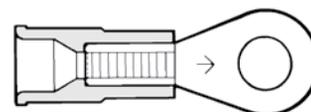

Used where insulated barrel is necessary and desirable. Terminal consists of brazed or butted part with flared, rigid molded polyvinyl chloride sleeve securely attached and funneled for easy wire entry. Wire insulation positions itself against funnel portion of vinyl sleeve thus eliminating strand hang-up. Crimping barrel and flared portion of sleeve provide excellent electrical contact plus mechanical stress relief at junction of insulation and barrel. Insulation has a non-slip ridge for ease of positioning crimping tool.

Industry standard color coding indicates wire range. Insulators are rated at a continuous operating temperature range from -40°F to 221°F (-40°C to 105°C).

UL Listed and CSA Certified for 600V building wire and 1000V signs and lighting fixtures (luminaries).

Nylon Insulated Butted Seam with Insulation Grip

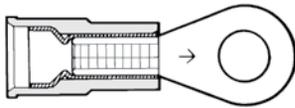

Used where insulated barrel and positive insulation grip are necessary or desirable. Terminal consists of butted seam part with flared, seamless brass sleeve securely attached and covered with flared, molded nylon sleeve. Wire insulation positions itself against funnel portion of brass sleeve. Crimping barrel and flared portion of sleeve provide excellent electrical contact plus mechanical stress relief at junction of insulation and barrel. Positioning crimp tool is nearly mistake proof due to a “step” in nylon insulation. Industry standard color coding indicates wire range. Insulators are rated at a continuous operating temperature range from -40°F to 221°F (-40°C to 105°C).

UL Listed and CSA Certified for 600V building wire and 1000V signs and lighting fixtures (luminaries).

Installation Procedure

Funnel Barrel Feature provides an excellent electrical and mechanical connection.

- Funnel design guides wire into position.

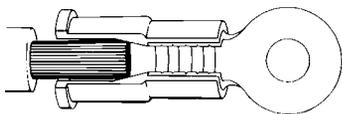

- No wire strand hang-up as the wire is inserted, giving a fast, positive installation.

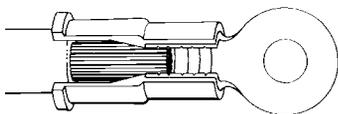

- Wire is in place, ready for crimping.

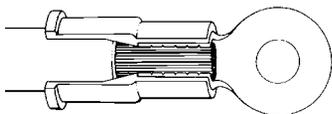

For maximum crimping performance, barrel of connector must be properly indexed in the crimp tool station.

Correct crimping is important to assure a strong connection.

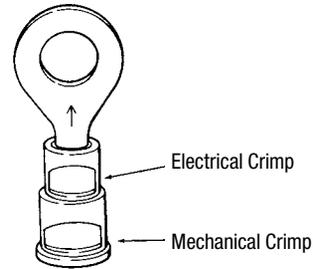

Insulated Terminals and Connectors:



Non-Insulated Terminals and Connectors:

Indent should be opposite the barrel seam.

Heat Shrink Terminals, Connectors and Disconnects

3M™ Heat Shrink pre-insulated terminals, connectors and disconnects protect against the most challenging of environments, making the best moisture protection available. They offer several advantages over conventional unsealed products.

Corrosion Resistance

The adhesive-lined heat shrink material, when properly crimped and shrunk, provides a seal resistant to water, salt, steam and other related contaminants.

Improved Mechanical Performance

The adhesive-lined heat shrink tubing adheres, when shrunk, to both the connector and the wire insulation providing improved pullout strength and strain relief.

Durable Heat Shrink Tubing

Tough heat shrink tubing effectively resists abrasion, scoring, cut-through, and the effects of long-term aging.

Versatile and Easy to Use

3M heat shrink terminals, splices and disconnects are available in wire sizes 22–10 AWG and can be installed easily with a recommended tool and heat source. The connectors are color-coded for wire range identification and the transparent tubing allows for visual inspection.

Application Procedure for Heat Shrink Products:

1. Strip wires to appropriate length as indicated on package label.



2. Insert wire into terminal and crimp with correct station of a recommended tool.

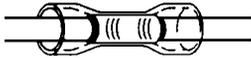

3. Apply heat with a recommended heat source.

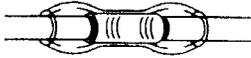

High Temperature Terminals and Connectors

3M high temperature terminals and connectors are constructed of steel with a nickel plating. Their temperature rating for continuous use at 900°F (482°C) makes them perfect for use in ovens, motors, light fixtures and other applications where other connectors would corrode or melt.

There is no applicable UL or CSA standard for high temperature steel parts.

Standard Crimp Terminal and Connector Specifications

Materials

Crimp terminals and connectors are to be burr-free, annealed and bright-tin plated ETP copper. Barrels shall be 0.25" long with brazed seams where specified. Insulation grip sleeves are to be tin-plated brass and attached securely to the barrel. Terminal insulators are to be molded polyvinyl chloride or nylon, UL Listed and CSA Certified for 600V in building wire and 1000V in signs and lighting fixtures (luminaries). Connector insulators are to be extruded polyvinyl chloride or nylon with a temperature rating of 221°F (105°C).

Construction

All insulated terminals are to have funnel entry construction to prevent strand hang-up and a crimp ridge for proper tool location. Nylon insulated terminals and connectors are to have butted seam barrels with insulation grip sleeves. All terminal barrels are to have multiple "V" grooves for maximum conductor retention.

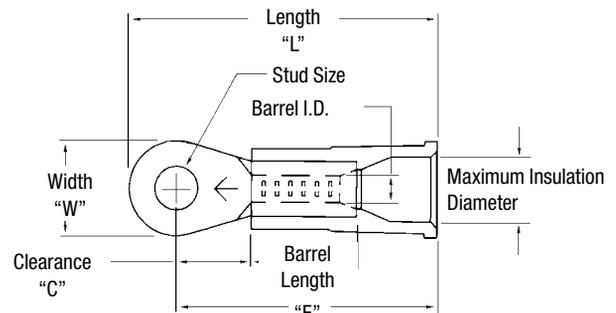

Note: All dimensions are measured in inches.

3M™ Terminal Numbering System

3M Identity	Code/Barrel Style	Wire Size Code (AWG)	–	Stud, Tab, or Bullet Size	Tongue Code	Product Availability**
M	No Code = Bare Brazed A = No Barrel (adapter) I = Double Wall w/interlock N = Nylon Brazed NG = Nylon w/ Grip NHU = Nylon/Butted w/ Heat Shrink Over Top NU = Nylon/Butted U = Bare/Butted V = Vinyl/Brazed VA = Vinyl Adapter VU = Vinyl/Butted	24 = 26–24 (yellow) 20 = 26–20 (yellow) 18 = 22–18 (red) 14 = 16–14 (blue) 10 = 12–10 (yellow) 8 = 8 (red) 6 = 6 (blue) 4 = 4 (yellow)	–	(STUD) 0 = 0 2 = 2 4 = 4 6 = 6 8 = 8 10 = 10 12 = 1/2" 14 = 1/4" 38 = 3/8" 516 = 5/16" 610 = 6, 8 10 (TAB) 110 = 0.110" x 0.020" 110/32 = 0.110" x 0.032" 187 = 0.187" x 0.020" 250 = 0.250" x 0.032" 375 = 0.375" x 0.050" (BULLET) 156 = 0.156" Dia. 180 = 0.180" Dia. 47 = 0.47 pin length 55 = 0.55 pin length	F = Fork FB = Fork, Block FBHT = Fork, Block, High Temp. FFB = Fork, Flanged, Block FHT = Fork, High Temp. FL = Fork, Locking R = Ring RHD = Ring, Heavy Duty RHT = Ring, High Temp. /S = Short or Small /L = Large or Long R/Flag = Ring, Flag BC = Butt Connector CEC = Closed End Connector P = Pin Connector PC = Parallel Connector BCM = Butt Connector Moisture Res. CEC/ST = Closed End Connector, Steel Insert Disconnect DF = Female DFHT = Female, High Temp. DFI = Female, Fully Insulated DM = Male DMF = Male, Female DMHT = Male, High Temp. DMI = Male, Fully Insulated DF/Flag = Female Flag Adapter D = Disconnects F = Female FFI = Double Female, Fully Insulated M = Male MMI = Double Male, Fully Insulated MMF = Double Male, Female MFM = Male, Female, Male, Stacking RR = Ring Rectangular Tongue Fuse = Fuse Adapter Clip	All box (X) package terminals in this catalog are available (in the packaging quantity indicated) from local distributor stocks. All bulk (K) packaged terminals are available in full cartons only, and may require a three to five week order lead time from the factory.

* A dash (–) separates the wire size code from the stud, tab or bullet size code.

** Denotes product packaging. Packaging of 3M Scotchlok™ terminals should be specified by using the appropriate terminal part number. Suffix letters are indicated within each product number. (See “Product Number” heading in ordering information charts.)

Note: Contact your local distributor or 3M sales office for price and delivery information.

Map of Numbering System

Example:

Catalog Number: MNG18-4 FB/SK

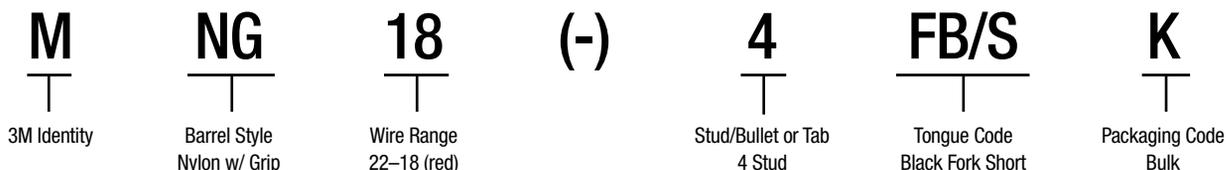

Insulator Color Coding

Yellow (26-24 AWG) Red (22-18 AWG) Blue (16-14 AWG) Yellow (12-10 AWG) Red (8 AWG) Blue (6 AWG) Yellow (4 AWG)

*Product number ending in X = box; product number ending with K = bulk.

Ring Tongues

3M™ Ring Tongues — Non-Insulated Brazed Seam 22-18 AWG



Product Number*	UPC (054007-)	Wire Range (AWG)	Stud Size	W	C	L	E	Thickness	Barrel Length	Barrel I.D.	Terminals per: Carton	Case
M18-4R/SX	49590	22-18	4	0.25	0.22	0.60	0.47	0.030	0.25	0.070	100	500
M18-4R/SK	01014	22-18	4	0.25	0.22	0.60	0.47	0.030	0.25	0.070	—	1000
M18-6R/SX	21635	22-18	6	0.25	0.22	0.60	0.47	0.030	0.25	0.070	100	500
M18-6R/SK	01016	22-18	6	0.25	0.22	0.60	0.47	0.030	0.25	0.070	—	1000
M18-8R/LX	21643	22-18	8	0.31	0.33	0.74	0.58	0.030	0.25	0.070	100	500
M18-8R/LK	01021	22-18	8	0.31	0.33	0.74	0.58	0.030	0.25	0.070	—	1000
M18-10R/LX	21650	22-18	10	0.31	0.33	0.74	0.58	0.030	0.25	0.070	100	500
M18-10R/LK	01023	22-18	10	0.31	0.33	0.74	0.58	0.030	0.25	0.070	—	1000
M18-14R/SX	49591	22-18	1/4	0.47	0.40	0.89	0.65	0.030	0.25	0.070	100	500
M18-38RX	49593	22-18	3/8	0.56	0.40	0.93	0.65	0.030	0.25	0.070	100	500

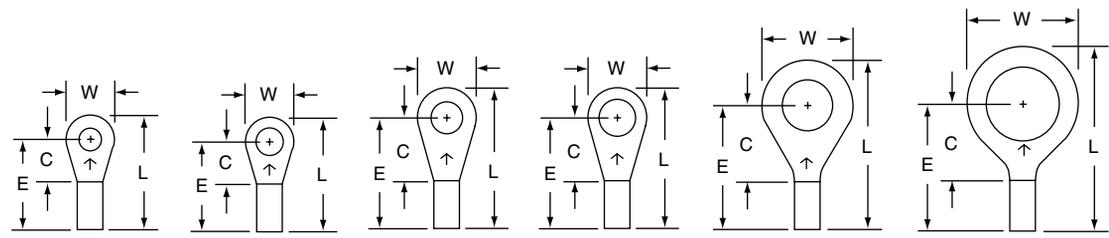

	M18-4R/S	M18-6R/S	M18-8R/L	M18-10R/L	M18-14R/S	M18-38R
Stud Size	4	6	8	10	1/4	3/8
Wire Range	22-18	22-18	22-18	22-18	22-18	22-18

*Product number ending in X = box; product number ending with K = bulk.

3M™ Ring Tongues — Non-Insulated Brazed Seam 16-14 AWG



Product Number	UPC (054007-)	Wire Range (AWG)	Stud Size	W	C	L	E	Thickness	Barrel Length	Barrel I.D.	Terminals per Carton	Case
M14-2R/SK	01379	16-14	2	0.25	0.22	0.60	0.47	0.030	0.25	0.090	—	1000
M14-4R/SX	49612	16-14	4	0.25	0.22	0.60	0.47	0.030	0.25	0.090	100	500
M14-6R/SX	22294	16-14	6	0.25	0.22	0.60	0.47	0.030	0.25	0.090	100	500
M14-6R/SK	01382	16-14	6	0.25	0.22	0.60	0.47	0.030	0.25	0.090	—	1000
M14-6R/LK	01384	16-14	6	0.31	0.33	0.74	0.58	0.030	0.25	0.090	—	1000
M14-8R/LX	22302	16-14	8	0.31	0.33	0.74	0.58	0.030	0.25	0.090	100	500
M14-8R/LK	13880	16-14	8	0.31	0.33	0.74	0.58	0.030	0.25	0.090	—	1000
M14-10RK	13929	16-14	10	0.33	0.29	0.70	0.54	0.030	0.25	0.090	—	1000
M14-10R/LX	22310	16-14	10	0.31	0.33	0.74	0.58	0.030	0.25	0.090	100	500
M14-10R/LK	01389	16-14	10	0.31	0.33	0.74	0.58	0.030	0.25	0.090	—	1000
M14-14R/SX	22328	16-14	1/4	0.47	0.40	0.89	0.65	0.030	0.25	0.090	100	500
M14-14R/SK	01390	16-14	1/4	0.47	0.40	0.89	0.65	0.030	0.25	0.090	—	1000
M14-516R/SK	01392	16-14	5/16	0.47	0.40	0.89	0.65	0.030	0.25	0.090	—	1000
M14-38RX	49614	16-14	3/8	0.56	0.40	0.93	0.65	0.030	0.25	0.090	100	500

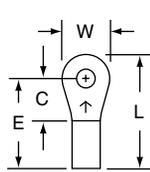

M14-2R/S

Stud Size

2

Wire Range

16-14

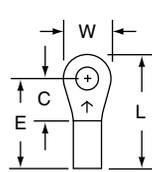

M14-4R/S

4

16-14

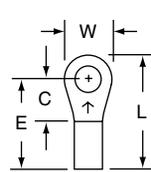

M14-6R/S

6

16-14

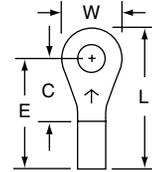

M14-6R/L

6

16-14

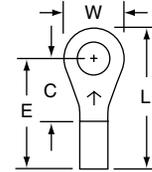

M14-8R/L

8

16-14

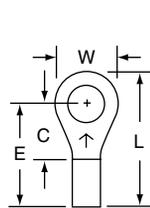

M14-10R

Stud Size

10

Wire Range

16-14

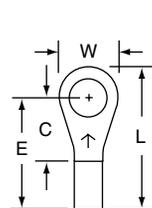

M14-10R/L

10

16-14

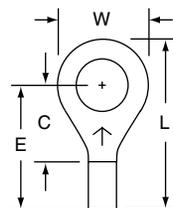

M14-14R/S

1/4

16-14

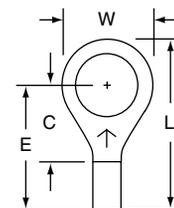

M14-516R/S

5/16

16-14

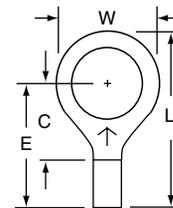

M14-38R

3/8

16-14

*Product number ending in X = box; product number ending with K = bulk.

3M™ Ring Tongues — Non-Insulated Brazed Seam 12-10 AWG



Product Number*	UPC (054007-)	Wire Range (AWG)	Stud Size	W	C	L	E	Thickness	Barrel Length	Barrel I.D.	Terminals per Carton	Case
M10-4R/SK	01890	12-10	4	0.28	0.29	0.68	0.54	0.040	0.25	0.135	—	500
M10-6RX	23250	12-10	6	0.38	0.29	0.73	0.54	0.040	0.25	0.135	50	500
M10-6RK	01892	12-10	6	0.38	0.29	0.73	0.54	0.040	0.25	0.135	—	500
M10-8RX	23268	12-10	8	0.38	0.29	0.73	0.54	0.040	0.25	0.135	50	500
M10-8RK	01894	12-10	8	0.38	0.29	0.73	0.54	0.040	0.25	0.135	—	500
M10-10RX	23276	12-10	10	0.38	0.29	0.73	0.54	0.040	0.25	0.135	50	500
M10-10RK	14002	12-10	10	0.38	0.29	0.73	0.54	0.040	0.25	0.135	—	500
M10-14R/SX	23284	12-10	1/4	0.54	0.44	0.96	0.69	0.040	0.25	0.135	50	500
M10-14R/SK	01896	12-10	1/4	0.54	0.44	0.96	0.69	0.040	0.25	0.135	—	500
M10-516R/SX	49637	12-10	5/16	0.54	0.44	0.96	0.69	0.040	0.25	0.135	50	500
M10-38R/SX	49638	12-10	3/8	0.54	0.44	0.96	0.69	0.040	0.25	0.135	50	500
M10-38R/SK	01900	12-10	3/8	0.54	0.44	0.96	0.69	0.040	0.25	0.135	—	500
M10-12RK	01903	12-10	1/2	0.75	0.57	1.19	0.82	0.040	0.25	0.135	—	500

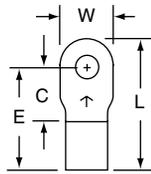

M10-4R/S

Stud Size

4

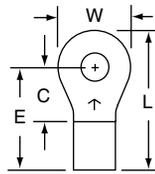

M10-6R

6

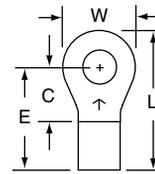

M10-8R

8

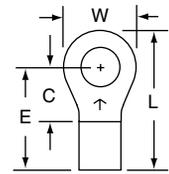

M10-10R

10

Wire Range

12-10

12-10

12-10

12-10

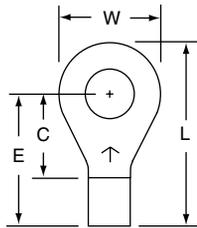

M10-14R/S

Stud Size

1/4

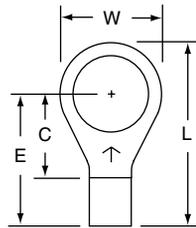

M10-516R/S

5/16

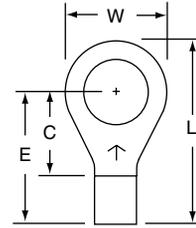

M10-38R/S

3/8

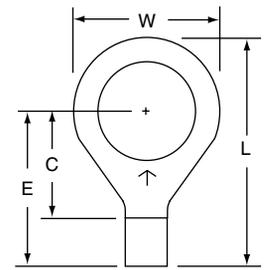

M10-12R

1/2

Wire Range

12-10

12-10

12-10

12-10

*Product number ending in X = box; product number ending with K = bulk.

3M™ Ring Tongues — Non-Insulated Brazed Seam 8 AWG



Product Number*	UPC (054007-)	Wire Range (AWG)	Stud Size	W	C	L	E	Thickness	Barrel Length	Barrel I.D.	Terminals per Carton	Case
M8-10R/SX	24118	8	10	0.47	0.40	0.95	0.72	0.050	0.31	0.175	25	250
M8-10R/SK	02118	8	10	0.47	0.40	0.95	0.72	0.050	0.31	0.175	—	200
M8-14R/SX	24126	8	1/4	0.47	0.40	0.95	0.72	0.050	0.31	0.175	25	250
M8-516RX	24134	8	5/16	0.59	0.45	1.06	0.77	0.050	0.31	0.175	25	250
M8-516RK	02122	8	5/16	0.59	0.45	1.06	0.77	0.050	0.31	0.175	—	200
M8-38RX	24142	8	3/8	0.59	0.45	1.06	0.77	0.050	0.31	0.175	25	250
M8-38RK	02123	8	3/8	0.59	0.45	1.06	0.77	0.050	0.31	0.175	—	200
M8-12R/SK	02126	8	1/2	0.81	0.69	1.41	1.00	0.050	0.31	0.175	—	200

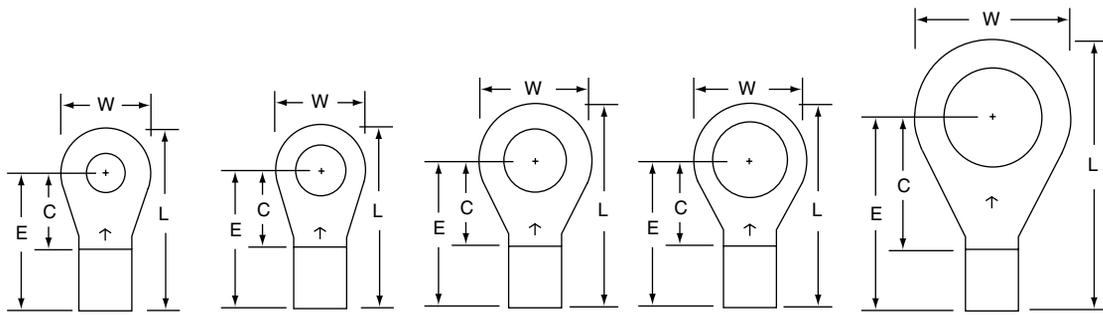

M8-10R/S

M8-14R/S

M8-516R

M8-38R

M8-12R/S

Stud Size

10

1/4

5/16

3/8

1/2

Wire Range

8

8

8

8

8

*Product number ending in X = box; product number ending with K = bulk.

3M™ Ring Tongues — Non-Insulated Brazed Seam 6 AWG



Product Number*	UPC (054007-)	Wire Range (AWG)	Stud Size	W	C	L	E	Thickness	Barrel Length	Barrel I.D.	Terminals per Carton	Terminals per Case
M6-10R/SX	24175	6	10	0.47	0.52	1.14	0.91	0.050	0.39	0.250	20	200
M6-10R/SK	02147	6	10	0.47	0.52	1.14	0.91	0.050	0.39	0.250	—	200
M6-14R/SX	24183	6	1/4	0.47	0.52	1.14	0.91	0.050	0.39	0.250	20	200
M6-14R/SK	02149	6	1/4	0.47	0.52	1.14	0.91	0.050	0.39	0.250	—	200
M6-516RX	24191	6	5/16	0.63	0.52	1.22	0.91	0.050	0.39	0.250	20	200
M6-516RK	02151	6	5/16	0.63	0.52	1.22	0.91	0.050	0.39	0.250	—	200
M6-38RX	24209	6	3/8	0.63	0.52	1.22	0.91	0.050	0.39	0.250	20	200
M6-38RK	02152	6	3/8	0.63	0.52	1.22	0.91	0.050	0.39	0.250	—	200
M6-12R/SK	02155	6	1/2	0.81	0.63	1.42	1.02	0.050	0.39	0.250	—	200

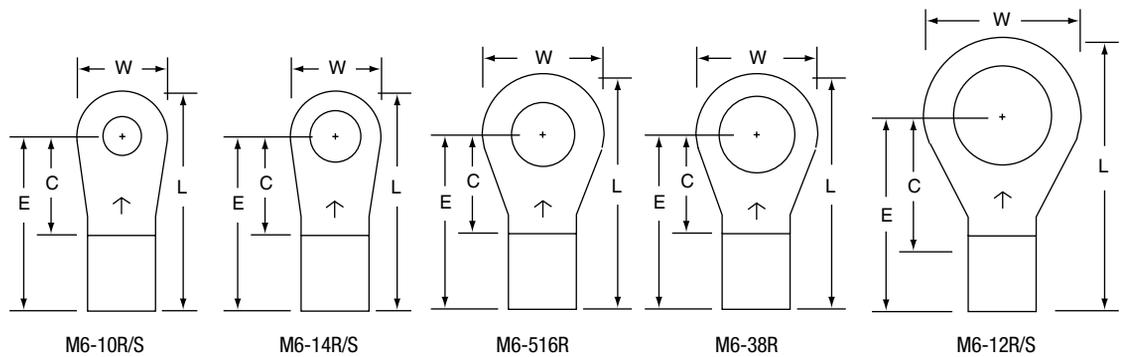

	M6-10R/S	M6-14R/S	M6-516R	M6-38R	M6-12R/S
Stud Size	10	1/4	5/16	3/8	1/2
Wire Range	6	6	6	6	6

*Product number ending in X = box; product number ending with K = bulk.

3M™ Ring Tongues — Non-Insulated Brazed Seam 4 AWG



Product Number*	UPC (054007-)	Wire Range (AWG)	Stud Size	W	C	L	E	Thickness	Barrel Length	Barrel I.D.	Terminals per Carton	Case
M4-10RX	49648	4	10	0.68	0.53	1.34	1.00	0.075	0.47	0.280	20	200
M4-10RK	02176	4	10	0.68	0.53	1.34	1.00	0.075	0.47	0.280	—	200
M4-14RX	24241	4	1/4	0.68	0.53	1.34	1.00	0.075	0.47	0.280	20	200
M4-14RK	02177	4	1/4	0.68	0.53	1.34	1.00	0.075	0.47	0.280	—	200
M4-516RX	24258	4	5/16	0.68	0.53	1.34	1.00	0.075	0.47	0.280	20	200
M4-516RK	02178	4	5/16	0.68	0.53	1.34	1.00	0.075	0.47	0.280	—	200
M4-38RX	24266	4	3/8	0.68	0.53	1.34	1.00	0.075	0.47	0.280	20	200
M4-38RK	02179	4	3/8	0.68	0.53	1.34	1.00	0.075	0.47	0.280	—	200
M4-12R/SK	02182	4	1/2	0.68	0.53	1.34	1.00	0.075	0.47	0.280	—	200

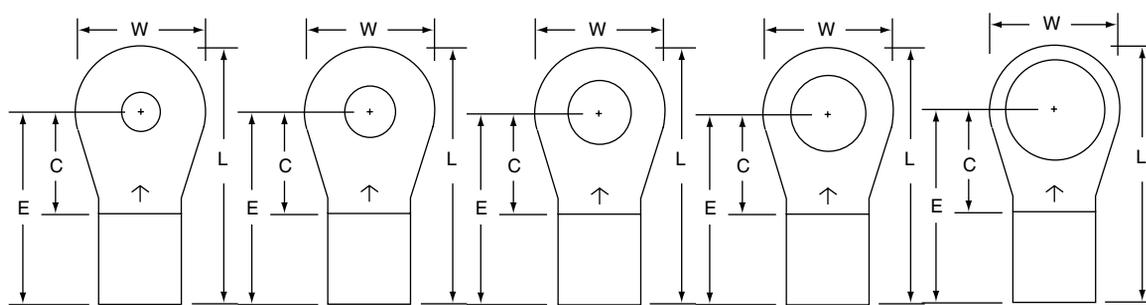

M4-10R

M4-14R

M4-516R

M4-38R

M4-12R/S

Stud Size
Wire Range

10

4

1/4

4

5/16

4

3/8

4

1/2

4

*Product number ending in X = box; product number ending with K = bulk.

3M™ Large Gauge Ring Tongues — Non-Insulated Copper Seamless 2 AWG



Product Number*	UPC (054007-)	Color Code	Wire Range (AWG)	Stud Size	W	C	L	Thickness	Barrel I.D.	Inner Unit Pack	Case Qty.
MC2-14RX	09187	Brown	2 AWG	1/4"	0.65"	0.41"	1.69"	0.10"	0.34"	10/box	100
				(6 mm ²)	(16,5 mm)	(10,4 mm)	(42,9 mm)	(2,5 mm)	(8,6 mm)		
MC2-516RX	09188	Brown	2 AWG	5/16"	0.65"	0.41"	1.69"	0.10"	0.34"	10/box	100
				(8 mm ²)	(16,5 mm)	(10,4 mm)	(42,9 mm)	(2,5 mm)	(8,6 mm)		
MC2-38RX	09189	Brown	2 AWG	3/8"	0.65"	0.41"	1.69"	0.10"	0.34"	10/box	100
				(10 mm ²)	(16,5 mm)	(10,4 mm)	(42,9 mm)	(2,5 mm)	(8,6 mm)		

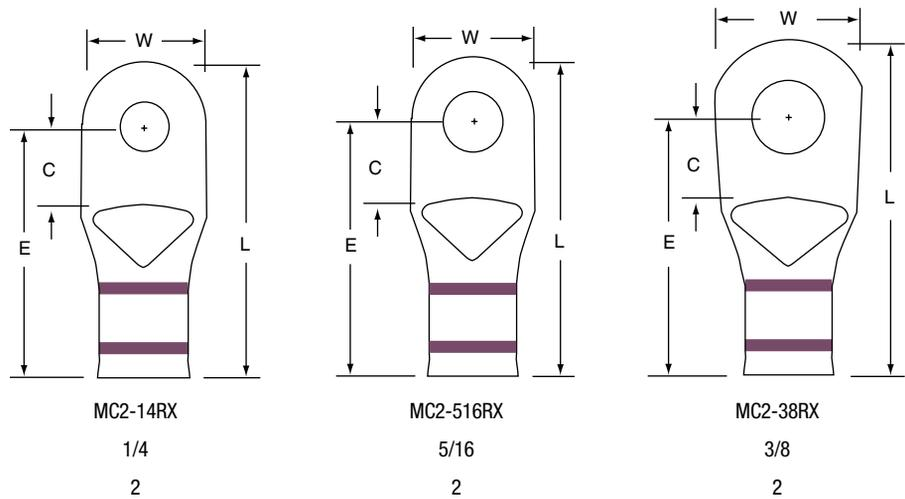

*Product number ending in X = box; product number ending with K = bulk.

3M™ Large Gauge Ring Tongues — Non-Insulated Copper Seamless 1 AWG



Product Number*	UPC (054007-)	Color Code	Wire Range (AWG)	Stud Size	W	C	L	Thickness	Barrel I.D.	Inner Unit Pack	Case Qty.
MC1-14RX	09190	Green	1 AWG	1/4"	0.65"	0.43"	1.71"	0.10"	0.36"	10/box	100
				(6 mm ²)	(16,5 mm)	(10,9 mm)	(43,4 mm)	(2,5 mm)	(9,1 mm)		
MC1-516RX	09191	Green	1 AWG	5/16"	0.65"	0.43"	1.71"	0.10"	0.36"	10/box	100
				(8 mm ²)	(16,5 mm)	(10,9 mm)	(43,4 mm)	(2,5 mm)	(9,1 mm)		
MC1-38RX	09192	Green	1 AWG	3/8"	0.68"	0.43"	1.71"	0.10"	0.36"	10/box	100
				(10 mm ²)	(17,3 mm)	(10,9 mm)	(43,4 mm)	(2,5 mm)	(9,1 mm)		

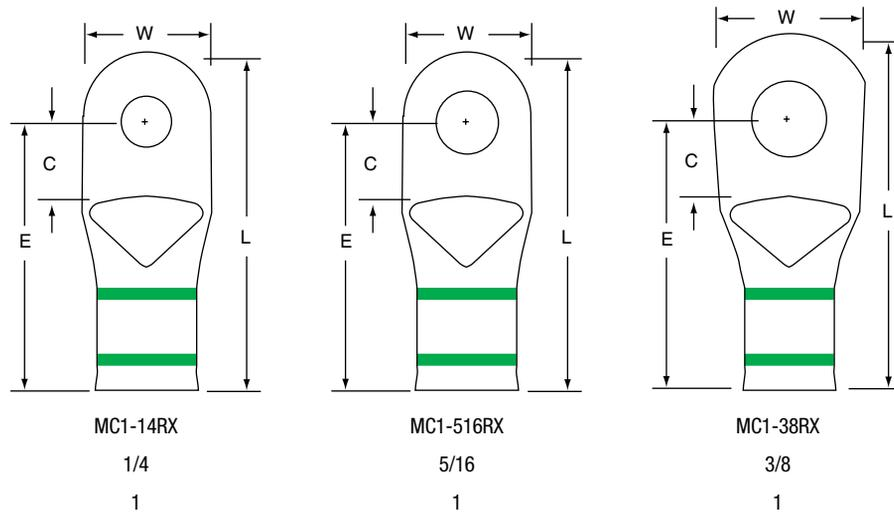

*Product number ending in X = box; product number ending with K = bulk.



3M™ Large Gauge Ring Tongues — Non-Insulated Copper Seamless 1/0 AWG Ⓢ Ⓞ

Product Number*	UPC (054007-)	Color Code	Wire Range (AWG)	Stud Size	W	C	L	Thickness	Barrel I.D.	Inner Unit Pack	Case Qty.
MC1/0-14RX	09193	Pink	1/0 AWG	1/4"	0.75"	0.38"	1.84"	0.10"	0.41"	10/box	100
				(6 mm)	(19,0 mm)	(9,7 mm)	(46,7 mm)	(2,5 mm)	(10,4 mm)		
MC1/0-38RX	09194	Pink	1/0 AWG	3/8"	0.75"	0.42"	1.84"	0.10"	0.41"	10/box	100
				(8 mm)	(19,0 mm)	(10,7 mm)	(46,7 mm)	(2,5 mm)	(10,4 mm)		
MC1/0-12RX	09195	Pink	1/0 AWG	1/2"	0.75"	0.42"	1.84"	0.10"	0.41"	10/box	100
				(12 mm)	(19,0 mm)	(10,7 mm)	(46,7 mm)	(2,5 mm)	(10,4 mm)		

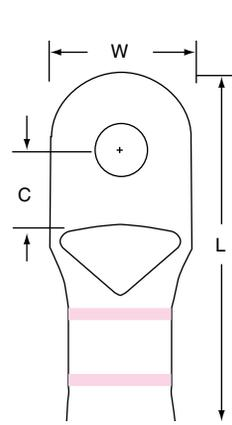

MC1/0-14RX

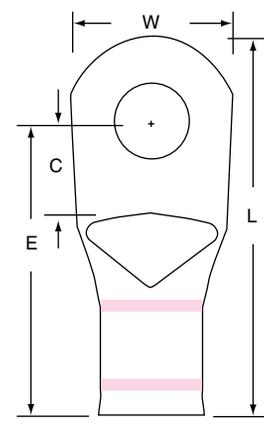

MC1/0-38RX

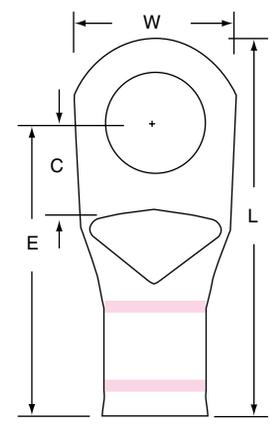

MC1/0-12RX

Stud Size
Wire Range

1/4
1/0

3/8
1/0

1/2
1/0

*Product number ending in X = box; product number ending with K = bulk.

3M™ Large Gauge Ring Tongues — Non-Insulated Copper Seamless 2/0 AWG Ⓢ Ⓞ

Product Number	UPC (054007-)	Color Code	Wire Range (AWG)	Stud Size	W	C	L	Thickness	Barrel I.D.	Inner Unit Pack	Case Qty.
MC2/0-38RX	09197	Black	2/0 AWG	3/8"	0.83"	0.48"	2.05"	0.10"	0.46"	10/box	100
				(10 mm)	(21,1 mm)	(12,2 mm)	(52,1 mm)	(2,5 mm)	(11,7 mm)		
MC2/0-12RX	09198	Black	2/0 AWG	1/2"	0.83"	0.48"	2.05"	0.10"	0.46"	10/box	100
				(12 mm)	(21,1 mm)	(12,2 mm)	(52,1 mm)	(2,5 mm)	(11,7 mm)		

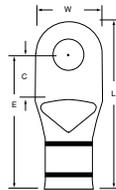

MC2/0-38RX

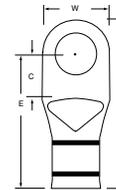

MC2/0-12RX

Stud Size
Wire Range

3/8
2/0

1/2
2/0

3M™ Large Gauge Ring Tongues — Non-Insulated Copper Seamless 3/0 AWG Ⓢ Ⓞ

Product Number	UPC (054007-)	Color Code	Wire Range (AWG)	Stud Size	W	C	L	Thickness	Barrel I.D.	Inner Unit Pack	Case Qty.
MC3/0-38RX	09199	Orange	3/0 AWG	3/8"	0.91"	0.50"	2.24"	0.12"	0.51"	6/box	60
				(10 mm)	(23,1 mm)	(12,7 mm)	(56,9 mm)	(3,1 mm)	(13,0 mm)		
MC3/0-12RX	09200	Orange	3/0 AWG	1/2"	0.91"	0.50"	2.24"	0.12"	0.51"	6/box	60
				(12 mm)	(23,1 mm)	(12,7 mm)	(56,9 mm)	(3,1 mm)	(13,0 mm)		

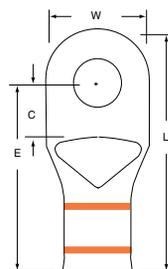

MC3/0-38RX

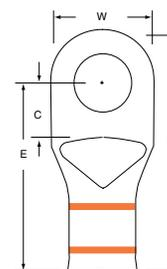

MC3/0-12RX

Stud Size
Wire Range

3/8
3/0

1/2
3/0

Product number ending in X = box; product number ending with K = bulk.

3M™ Large Gauge Ring Tongues — Non-Insulated Copper Seamless 4/0 AWG-250 kcmil



Product Number*	UPC (054007-)	Color Code	Wire Range (AWG)	Stud Size	W	C	L	Thickness	Barrel I.D.	Inner Unit Pack	Case Qty.
MC4/0-38RX	09201	Purple	4/0 AWG	3/8"	1.00"	0.52"	2.29"	0.125"	0.56"	6/box	60
				(10 mm)	(25,4 mm)	(13,2 mm)	(58,2 mm)	(3,2 mm)	(14,2 mm)		
MC4/0-12RX	09202	Purple	4/0 AWG	1/2"	1.00"	0.52"	2.29"	0.125"	0.56"	6/box	60
				(12 mm)	(25,4 mm)	(13,2 mm)	(58,2 mm)	(3,2 mm)	(14,2 mm)		
MC250-38RX	09203	Yellow	250 kcmil	3/8"	1.13"	0.60"	2.43"	0.14"	0.63"	6/box	60
				(10 mm)	(28,7 mm)	(15,2 mm)	(61,7 mm)	(3,6 mm)	(16,0 mm)		
MC250-12RX	09204	Yellow	250 kcmil	1/2"	1.13"	0.60"	2.43"	0.14"	0.63"	6/box	60
				(12 mm)	(28,7 mm)	(15,2 mm)	(61,7 mm)	(3,6 mm)	(16,0 mm)		

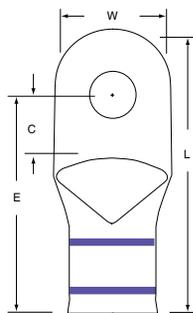

MC4/0-38RX

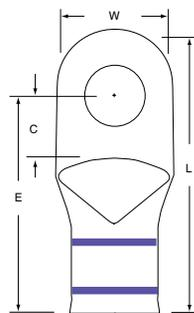

MC4/0-12RX

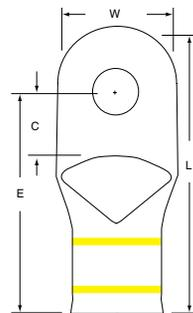

MC250-38RX

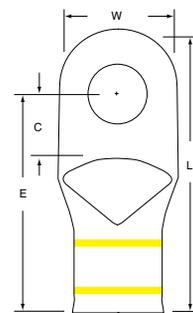

MC250-12RX

Stud Size	3/8	1/2	3/8	1/2
Wire Range	4/0	4/0	250 (kcmil)	250 (kcmil)

3M™ Ring Tongues — Non-Insulated Butted Seam 26-24 AWG

Product Number*	UPC (054007-)	Wire Range (AWG)	Stud Size	W	C	L	E	Thickness	Barrel Length	Barrel I.D.	Terminals per Case
MU24-2RK	00958	26-24	2	0.14	0.12	0.31	0.24	0.020	0.13	0.030	1000
MU24-4RK	00959	26-24	4	0.20	0.21	0.45	0.35	0.020	0.14	0.030	1000
MU24-8RK	00961	26-24	8	0.25	0.28	0.53	0.40	0.020	0.13	0.030	1000

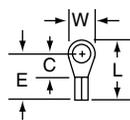

MU24-2R

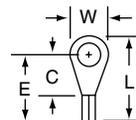

MU24-4R

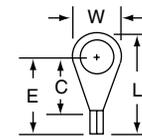

MU24-8R

Stud Size	2	4	8
Wire Range	26-24	26-24	26-24

*Product number ending in X = box; product number ending with K = bulk.

3M™ Ring Tongues — Non-Insulated Butted Seam 22-18 AWG



Product Number*	UPC (054007-)	Wire Range (AWG)	Stud Size	W	C	L	E	Thickness	Barrel Length	Barrel I.D.	Terminals per Case
MU18-4R/SK	00998	22-18	4	0.25	0.22	0.60	0.47	0.030	0.25	0.070	1000
MU18-6R/SK	01000	22-18	6	0.25	0.22	0.60	0.47	0.030	0.25	0.070	1000
MU18-8R/LK	01005	22-18	8	0.31	0.33	0.74	0.58	0.030	0.25	0.070	1000
MU18-10R/LK	01007	22-18	10	0.31	0.33	0.74	0.58	0.030	0.25	0.070	1000
MU18-14R/SK	01008	22-18	1/4	0.47	0.40	0.89	0.65	0.030	0.25	0.070	1000
MU18-38RK	01012	22-18	3/8	0.56	0.40	0.93	0.65	0.030	0.25	0.070	1000

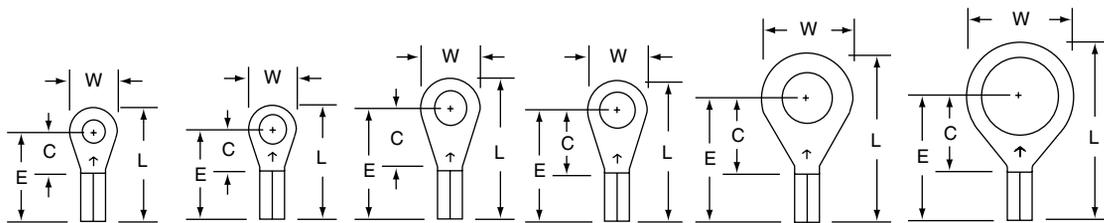

	MU18-4R/S	MU18-6R/S	MU18-8R/L	MU18-10R/L	MU18-14R/S	MU18-38R
Stud Size	4	6	8	10	1/4	3/8
Wire Range	22-18	22-18	22-18	22-18	22-18	22-18

3M™ Ring Tongues — Non-Insulated Butted Seam 16-14 AWG



Product Number*	UPC (054007-)	Wire Range (AWG)	Stud Size	W	C	L	E	Thickness	Barrel Length	Barrel I.D.	Terminals per Case
MU14-4R/SK	01364	16-14	4	0.25	0.22	0.60	0.47	0.030	0.25	0.090	1000
MU14-6R/SK	01366	16-14	6	0.25	0.22	0.60	0.47	0.030	0.25	0.090	1000
MU14-8R/LK	01371	16-14	8	0.31	0.33	0.74	0.58	0.030	0.25	0.090	1000
MU14-10RK	01372	16-14	10	0.33	0.29	0.70	0.54	0.030	0.25	0.090	1000
MU14-10R/LK	01373	16-14	10	0.31	0.33	0.74	0.58	0.030	0.25	0.090	1000
MU14-14R/SK	01374	16-14	1/4	0.47	0.40	0.89	0.65	0.030	0.25	0.090	1000

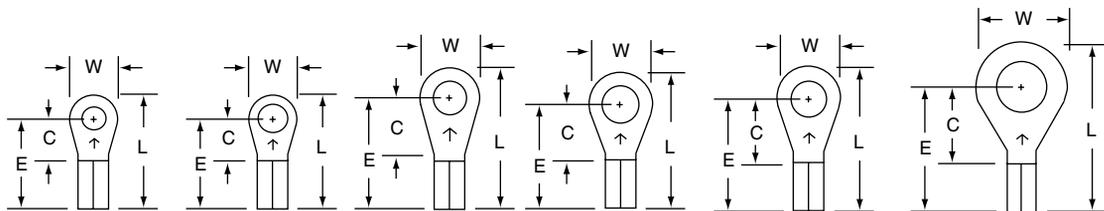

	MU14-4R/S	MU14-6R/S	MU14-8R/L	MU14-10R	MU14-10R/L	MU14-14R/S
Stud Size	4	6	8	10	10	1/4
Wire Range	16-14	16-14	16-14	16-14	16-14	16-14

*Product number ending in X = box; product number ending with K = bulk.

3M™ Ring Tongues — Non-Insulated Butted Seam 12-10 AWG



Product Number	UPC (054007-)	Wire Range (AWG)	Stud Size	W	C	L	E	Thickness	Barrel Length	Barrel I.D.	Terminals per Case
MU10-4R/SK	01876	12-10	4	0.28	0.29	0.68	0.54	0.040	0.25	0.135	500
MU10-6RK	01878	12-10	6	0.38	0.29	0.73	0.54	0.040	0.25	0.135	500
MU10-8RK	01880	12-10	8	0.38	0.29	0.73	0.54	0.040	0.25	0.135	500
MU10-10RK	01881	12-10	10	0.38	0.29	0.73	0.54	0.040	0.25	0.135	500
MU10-14R/SK	01882	12-10	1/4	0.53	0.44	0.96	0.69	0.040	0.25	0.135	500

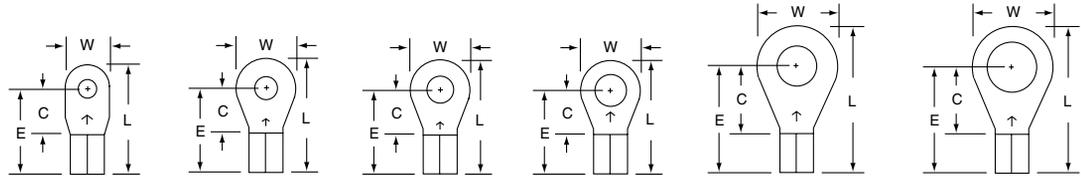

	MU10-4R/S	MU10-6R	MU10-8R	MU10-10R	MU10-14R/S	MU10-516R/S
Stud Size	4	6	8	10	1/4	5/16
Wire Range	12-10	12-10	12-10	12-10	12-10	12-10

3M™ Ring Tongues — Vinyl Insulated Brazed Seam 22-18 AWG



Product Number	UPC (054007-)	Wire Range (AWG)	Stud Size	W	C	L	E	Thickness	Barrel Length	Barrel I.D.	Maximum Insulation Diameter	Terminals per Carton	Case
MV18-4R/SX	21700	22-18	4	0.25	0.22	0.80	0.67	0.030	0.25	0.070	0.145	100	500
MV18-4R/SK	01046	22-18	4	0.25	0.22	0.80	0.67	0.030	0.25	0.070	0.145	—	1000
MV18-6R/SX	21718	22-18	6	0.25	0.22	0.80	0.67	0.030	0.25	0.070	0.145	100	500
MV18-6R/SK	01048	22-18	6	0.25	0.22	0.80	0.67	0.030	0.25	0.070	0.145	—	1000
MV18-8R/LX	21726	22-18	8	0.31	0.33	0.93	0.78	0.030	0.25	0.070	0.145	100	500
MV18-8R/LK	01053	22-18	8	0.31	0.33	0.93	0.78	0.030	0.25	0.070	0.145	—	1000
MV18-10R/LX	21734	22-18	10	0.31	0.33	0.93	0.78	0.030	0.25	0.070	0.145	100	500
MV18-10R/LK	01055	22-18	10	0.31	0.33	0.93	0.78	0.030	0.25	0.070	0.145	—	1000
MV18-14R/SX	21742	22-18	1/4	0.47	0.40	1.08	0.85	0.030	0.25	0.070	0.145	100	500
MV18-14R/SK	01056	22-18	1/4	0.47	0.40	1.08	0.85	0.030	0.25	0.070	0.145	—	1000
MV18-516R/SX	49594	22-18	5/16	0.47	0.40	1.08	0.85	0.030	0.25	0.070	0.145	100	500
MV18-38RX	21767	22-18	3/8	0.56	0.40	1.13	0.85	0.030	0.25	0.070	0.145	100	500
MV18-38RK	01060	22-18	3/8	0.56	0.40	1.13	0.85	0.030	0.25	0.070	0.145	—	1000

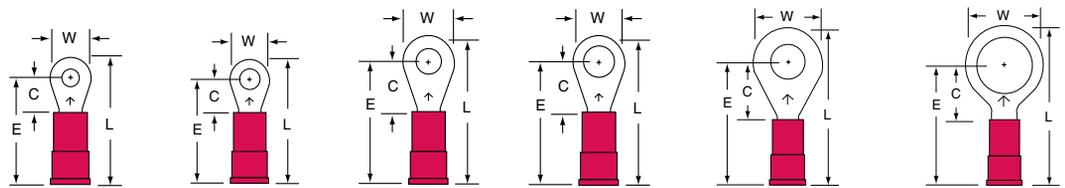

	MV18-4R/S	MV18-6R/S	MV18-8R/L	MV18-10R/L	MV18-14R/S	MV18-38R
Stud Size	4	6	8	10	1/4	3/8
Wire Range	22-18	22-18	22-18	22-18	22-18	22-18

*Product number ending in X = box; product number ending with K = bulk.

3M™ Ring Tongues — Vinyl Insulated Brazed Seam 16-14 AWG



Product Number ¹	UPC (054007-)	Wire Range (AWG)	Stud Size	W	C	L	E	Thickness	Barrel Length	Barrel I.D.	Maximum Insulation Diameter	Terminals per Carton	Case
MV14-4R/SX	22369	16-14	4	0.25	0.22	0.80	0.67	0.030	0.25	0.090	0.170	100	500
MV14-4R/SK	01412	16-14	4	0.25	0.22	0.80	0.67	0.030	0.25	0.090	0.170	—	1000
MV14-6R/SX	22377	16-14	6	0.25	0.22	0.80	0.67	0.030	0.25	0.090	0.170	100	500
MV14-6R/SK	01414	16-14	6	0.25	0.22	0.80	0.67	0.030	0.25	0.090	0.170	—	1000
MV14-8R/SK	01417	16-14	8	0.25	0.22	0.80	0.67	0.030	0.25	0.090	0.170	—	1000
MV14-8R/LX	22385	16-14	8	0.31	0.33	0.93	0.78	0.030	0.25	0.090	0.170	100	500
MV14-8R/LK	01419	16-14	8	0.31	0.33	0.93	0.78	0.030	0.25	0.090	0.170	—	1000
MV14-10RK	01420	16-14	10	0.33	0.29	0.90	0.74	0.030	0.25	0.090	0.170	—	1000
MV14-10R/LX	22393	16-14	10	0.31	0.33	0.93	0.78	0.030	0.25	0.090	0.170	100	500
MV14-10R/LK	01421	16-14	10	0.31	0.33	0.93	0.78	0.030	0.25	0.090	0.170	—	1000
MV14-14R/SX	22401	16-14	1/4	0.47	0.40	1.08	0.85	0.030	0.25	0.090	0.170	100	500
MV14-14R/SK	01422	16-14	1/4	0.47	0.40	1.08	0.85	0.030	0.25	0.090	0.170	—	1000
MV14-516R/SX	49615	16-14	5/16	0.47	0.40	1.08	0.85	0.030	0.25	0.090	0.170	100	500
MV14-516R/SK	01424	16-14	5/16	0.47	0.40	1.08	0.85	0.030	0.25	0.090	0.170	—	1000
MV14-38RX	22427	16-14	3/8	0.56	0.40	1.13	0.85	0.030	0.25	0.090	0.170	100	500
MV14-38RK	00546	16-14	3/8	0.56	0.40	1.13	0.85	0.030	0.25	0.090	0.170	—	1000

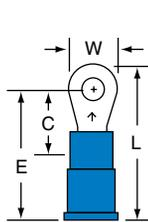

MV14-4R/S

Stud Size

4

Wire Range

16-14

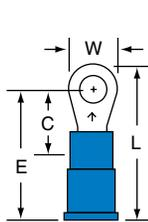

MV14-6R/S

6

16-14

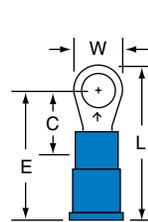

MV14-8R/S

8

16-14

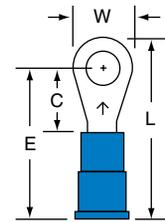

MV14-8R/L

8

16-14

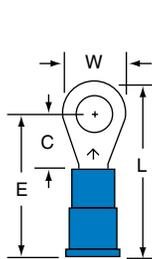

MV14-10R

Stud Size

10

Wire Range

16-14

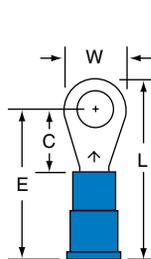

MV14-10R/L

10

16-14

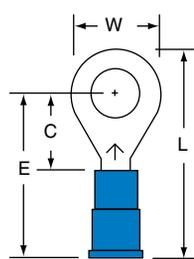

MV14-14R/S

1/4

16-14

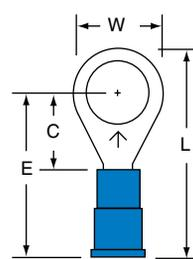

MV14-516R/S

5/16

16-14

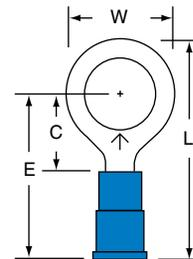

MV14-38R

3/8

16-14

¹Product number ending in X = box; product number ending with K = bulk.

3M™ Ring Tongues — Vinyl Insulated Brazen Seam 12-10 AWG



Product Number*	UPC (054007-)	Wire Range (AWG)	Stud Size	W	C	L	E	Thickness	Barrel Length	Barrel I.D.	Maximum Insulation Diameter	Terminals per Carton	Case
MV10-4R/SK	01918	12-10	4	0.28	0.29	0.98	0.84	0.040	0.25	0.135	0.250	—	500
MV10-6RX	23334	12-10	6	0.38	0.29	1.03	0.84	0.040	0.25	0.135	0.250	50	500
MV10-6RK	01920	12-10	6	0.38	0.29	1.03	0.84	0.040	0.25	0.135	0.250	—	500
MV10-8RX	23342	12-10	8	0.38	0.29	1.03	0.84	0.040	0.25	0.135	0.250	50	500
MV10-8RK	01922	12-10	8	0.38	0.29	1.03	0.84	0.040	0.25	0.135	0.250	—	500
MV10-10RX	23359	12-10	10	0.38	0.29	1.03	0.84	0.040	0.25	0.135	0.250	50	500
MV10-10RK	01923	12-10	10	0.38	0.29	1.03	0.84	0.040	0.25	0.135	0.250	—	500
MV10-14R/SX	23367	12-10	1/4	0.53	0.44	1.26	0.99	0.040	0.25	0.135	0.250	50	500
MV10-14R/SK	01924	12-10	1/4	0.53	0.44	1.26	0.99	0.040	0.25	0.135	0.250	—	500
MV10-516R/SX	23375	12-10	5/16	0.53	0.44	1.26	0.99	0.040	0.25	0.135	0.250	50	500
MV10-516R/SK	01926	12-10	5/16	0.53	0.44	1.26	0.99	0.040	0.25	0.135	0.250	—	500
MV10-38R/SX	49639	12-10	3/8	0.54	0.44	1.26	0.99	0.040	0.25	0.135	0.250	50	500
MV10-38R/SK	01928	12-10	3/8	0.54	0.44	1.26	0.99	0.040	0.25	0.135	0.250	—	500
MV10-12RX	23409	12-10	1/2	0.75	0.57	1.50	1.12	0.040	0.25	0.135	0.250	50	500
MV10-12RK	01931	12-10	1/2	0.75	0.57	1.50	1.12	0.040	0.25	0.135	0.250	—	500

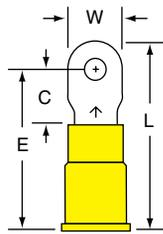

MV10-4R/S

Stud Size

4

Wire Range

12-10

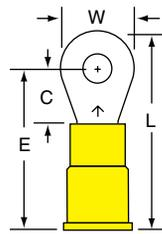

MV10-6R

6

12-10

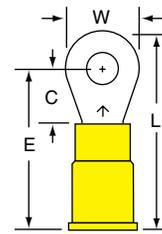

MV10-8R

8

12-10

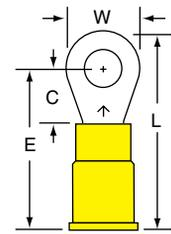

MV10-10R

10

12-10

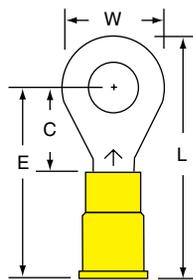

MV10-14R/S

Stud Size

1/4

Wire Range

12-10

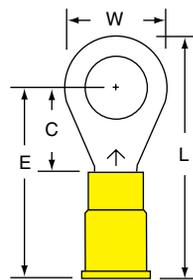

MV10-516R/S

5/16

12-10

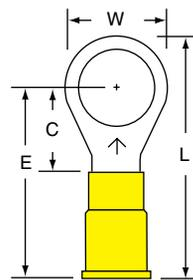

MV10-38R/S

3/8

12-10

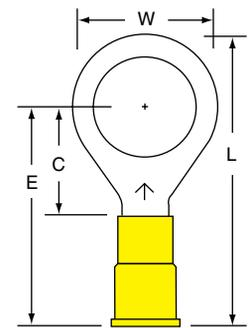

MV10-12R

1/2

12-10

*Product number ending in X = box; product number ending with K = bulk.

3M™ Ring Tongues — Vinyl Insulated Butted Seam 22-18 AWG



Product Number*	UPC (054007-)	Wire Range (AWG)	Stud Size	W	C	L	E	Thickness	Barrel Length	Barrel I.D.	Maximum Insulation Diameter	Terminals per Case
MVU18-4R/SK	01078	22-18	4	0.25	0.22	0.80	0.67	0.030	0.25	0.070	0.145	1000
MVU18-6R/SK	01080	22-18	6	0.25	0.22	0.80	0.67	0.030	0.25	0.070	0.145	1000
MVU18-8R/LK	01085	22-18	8	0.31	0.33	0.93	0.78	0.030	0.25	0.070	0.145	1000
MVU18-10R/LK	01087	22-18	10	0.31	0.33	0.93	0.78	0.030	0.25	0.070	0.145	1000
MVU18-14R/SK	01088	22-18	1/4	0.47	0.40	1.08	0.85	0.030	0.25	0.070	0.145	1000
MVU18-516R/SK	01090	22-18	5/16	0.47	0.40	1.08	0.85	0.030	0.25	0.070	0.145	1000
MVU18-38RK	01092	22-18	3/8	0.56	0.40	1.13	0.85	0.030	0.25	0.070	0.145	1000

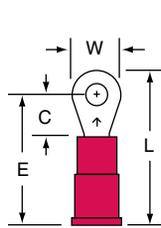

MVU18-4R/S

Stud Size
4

Wire Range
22-18

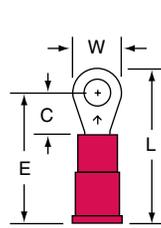

MVU18-6R/S

Stud Size
6

Wire Range
22-18

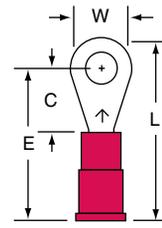

MVU18-8R/L

Stud Size
8

Wire Range
22-18

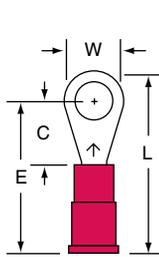

MVU18-10R/L

Stud Size
10

Wire Range
22-18

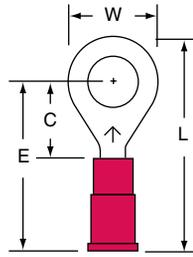

MVU18-14R/S

Stud Size
1/4

Wire Range
22-18

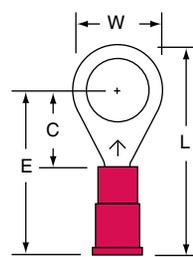

MVU18-516R/S

Stud Size
5/16

Wire Range
22-18

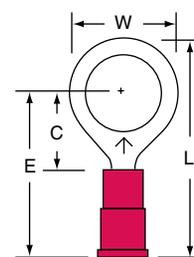

MVU18-38R

Stud Size
3/8

Wire Range
22-18

*Product number ending in X = box; product number ending with K = bulk.

3M™ Ring Tongues — Vinyl Insulated Butted Seam 16-14 AWG



Product Number*	UPC (054007-)	Wire Range (AWG)	Stud Size	W	C	L	E	Thickness	Barrel Length	Barrel I.D.	Maximum Insulation Diameter	Terminals per Case
MVU14-4R/SK	01444	16-14	4	0.25	0.22	0.80	0.67	0.030	0.25	0.090	0.170	1000
MVU14-6R/SK	01446	16-14	6	0.25	0.22	0.80	0.67	0.030	0.25	0.090	0.170	1000
MVU14-8R/SK	01449	16-14	8	0.25	0.22	0.80	0.67	0.030	0.25	0.090	0.170	1000
MVU14-8RK	01450	16-14	8	0.33	0.29	0.90	0.74	0.030	0.25	0.090	0.170	1000
MVU14-8R/LK	01451	16-14	8	0.31	0.33	0.93	0.78	0.030	0.25	0.090	0.170	1000
MVU14-10RK	01452	16-14	10	0.33	0.29	0.90	0.74	0.030	0.25	0.090	0.170	1000
MVU14-10R/LK	01453	16-14	10	0.31	0.33	0.93	0.78	0.030	0.25	0.090	0.170	1000
MVU14-14R/SK	01454	16-14	1/4	0.47	0.40	1.08	0.85	0.030	0.25	0.090	0.170	1000
MVU14-516R/SK	01456	16-14	5/16	0.47	0.40	1.08	0.85	0.030	0.25	0.090	0.170	1000
MVU14-38RK	01458	16-14	3/8	0.56	0.40	1.13	0.85	0.030	0.25	0.090	0.170	1000

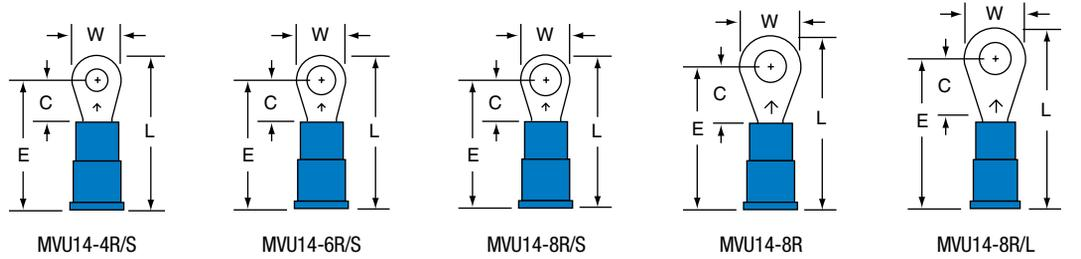

Stud Size	4	6	8	8	8
Wire Range	16-14	16-14	16-14	16-14	16-14

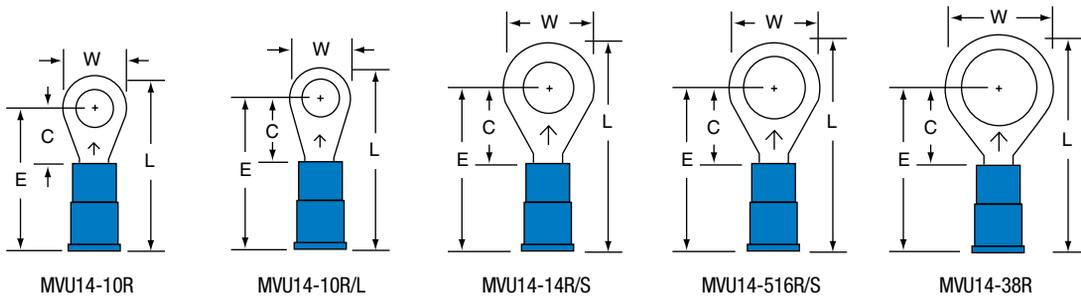

Stud Size	10	10	1/4	5/16	3/8
Wire Range	16-14	16-14	16-14	16-14	16-14

*Product number ending in X = box; product number ending with K = bulk.

3M™ Ring Tongues — Vinyl Insulated Butted Seam 12-10 AWG



Product Number*	UPC (054007-)	Wire Range (AWG)	Stud Size	W	C	L	E	Thickness	Barrel Length	Barrel I.D.	Maximum Insulation Diameter	Terminals per Case
MVU10-4R/SK	01946	12-10	4	0.28	0.29	0.98	0.84	0.040	0.25	0.135	0.250	500
MVU10-6RK	01948	12-10	6	0.38	0.29	1.03	0.84	0.040	0.25	0.135	0.250	500
MVU10-8RK	01950	12-10	8	0.38	0.29	1.03	0.84	0.040	0.25	0.135	0.250	500
MVU10-10RK	01951	12-10	10	0.38	0.29	1.03	0.84	0.040	0.25	0.135	0.250	500
MVU10-14R/SK	01952	12-10	1/4	0.53	0.44	1.26	0.99	0.040	0.25	0.135	0.250	500
MVU10-516R/SK	01954	12-10	5/16	0.53	0.44	1.26	0.99	0.040	0.25	0.135	0.250	500
MVU10-38R/SK	01956	12-10	3/8	0.54	0.44	1.26	0.99	0.040	0.25	0.135	0.250	500

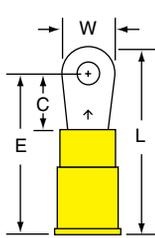

MVU10-4R/S

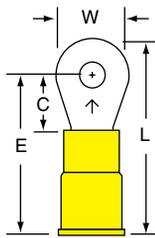

MVU10-6R

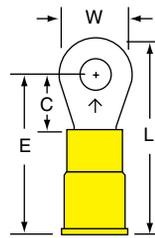

MVU10-8R

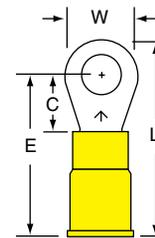

MVU10-10R

Stud Size

4

6

8

10

Wire Range

12-10

12-10

12-10

12-10

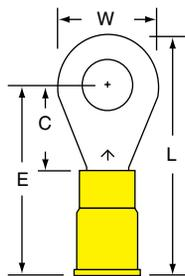

MVU10-14R/S

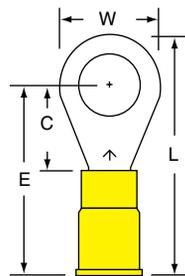

MVU10-516R/S

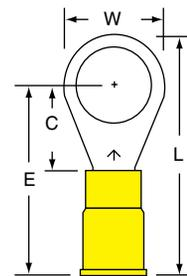

MVU10-38R/S

Stud Size

1/4

5/16

3/8

Wire Range

12-10

12-10

12-10

*Product number ending in X = box; product number ending with K = bulk.

3M™ Ring Tongues — Nylon Insulated Brazed Seam 8 AWG



Product Number*	UPC (054007-)	Wire Range (AWG)	Stud Size	W	C	L	E	Thickness	Barrel Length	Barrel I.D.	Maximum Insulation Diameter	Terminals per: Carton	Case
MN8-10R/SK	08267	8	10	0.47	0.40	1.26	1.03	0.050	0.31	0.175	0.340	—	200
MN8-14R/SX	15652	8	1/4	0.47	0.40	1.26	1.03	0.050	0.31	0.175	0.340	25	250
MN8-14R/SK	08268	8	1/4	0.47	0.40	1.26	1.03	0.050	0.31	0.175	0.340	—	200
MN8-516RK	08269	8	5/16	0.59	0.45	1.38	1.08	0.050	0.31	0.175	0.340	—	200
MN8-38RK	08270	8	3/8	0.59	0.45	1.38	1.08	0.050	0.31	0.175	0.340	—	200
MN8-12R/SK	08271	8	1/2	0.81	0.69	1.72	1.32	0.050	0.31	0.175	0.340	—	200

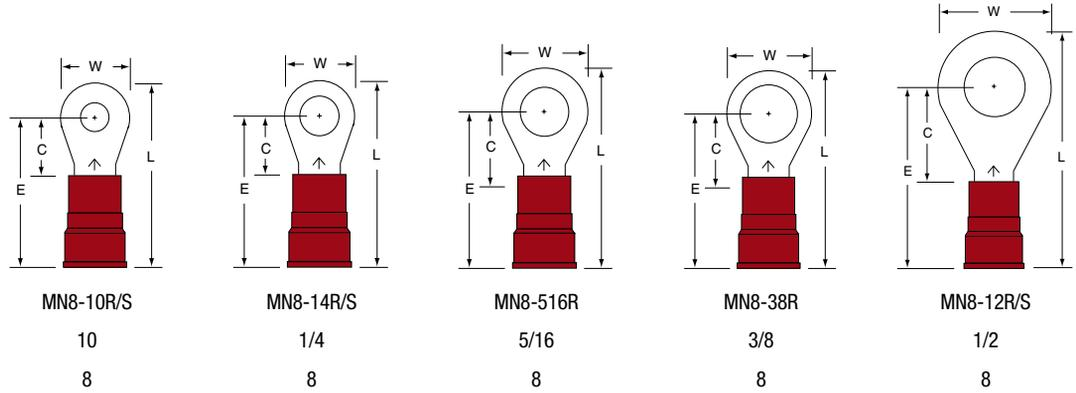

3M™ Ring Tongues — Nylon Insulated Brazed Seam 6 AWG



Product Number*	UPC (054007-)	Wire Range (AWG)	Stud Size	W	C	L	E	Thickness	Barrel Length	Barrel I.D.	Maximum Insulation Diameter	Terminals per: Carton	Case
MN6-10R/SK	08272	6	10	0.47	0.52	1.50	1.27	0.050	0.39	0.250	0.440	—	200
MN6-14R/SX	15660	6	1/4	0.47	0.52	1.50	1.27	0.050	0.39	0.250	0.440	20	200
MN6-14R/SK	08273	6	1/4	0.47	0.52	1.50	1.27	0.050	0.39	0.250	0.440	—	200
MN6-516RK	08274	6	5/16	0.63	0.52	1.58	1.27	0.050	0.39	0.250	0.440	—	200
MN6-38RK	08275	6	3/8	0.63	0.52	1.58	1.27	0.050	0.39	0.250	0.440	—	200
MN6-12R/SK	08276	6	1/2	0.81	0.63	1.78	1.38	0.050	0.39	0.250	0.440	—	200

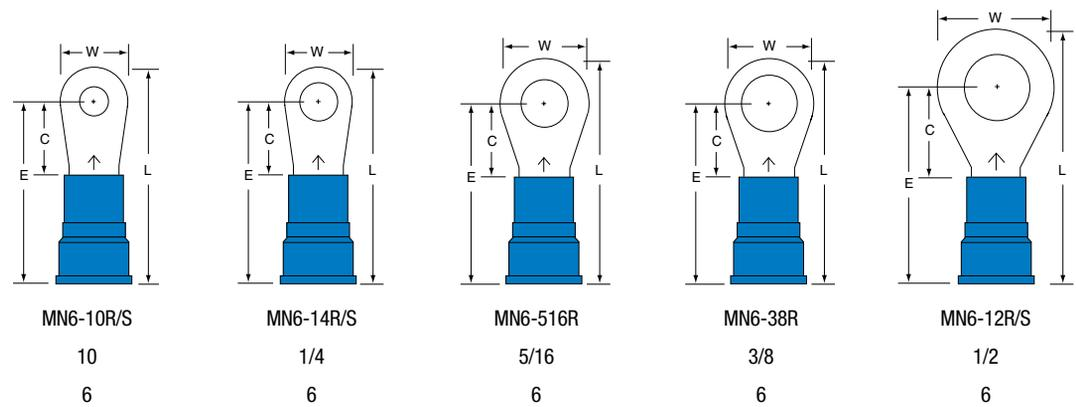

*Product number ending in X = box; product number ending with K = bulk.

3M™ Ring Tongues — Nylon Insulated Brazed Seam 4 AWG



Product Number ^a	UPC (054007-)	Wire Range (AWG)	Stud Size	W	C	L	E	Thickness	Barrel Length	Barrel I.D.	Maximum Insulation Diameter	Terminals per: Carton	Case
MN4-10RK	08277	4	10	0.68	0.53	1.74	1.41	0.075	0.47	0.280	0.515	—	200
MN4-14RK	08278	4	1/4	0.68	0.53	1.74	1.41	0.075	0.47	0.280	0.515	—	200
MN4-516RK	08279	4	5/16	0.68	0.53	1.74	1.41	0.075	0.47	0.280	0.515	—	200
MN4-38RK	08280	4	3/8	0.68	0.53	1.74	1.41	0.075	0.47	0.280	0.515	—	200
MN4-12R/SK	08281	4	1/2	0.68	0.53	1.74	1.41	0.075	0.47	0.280	0.515	—	200

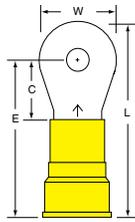

MN4-10R

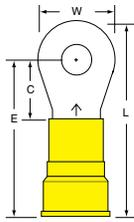

MN4-14R

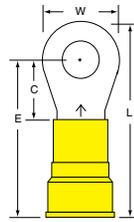

MN4-516R

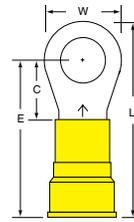

MN4-38R

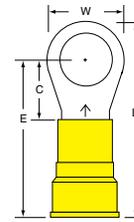

MN4-12R/S

Stud Size

10

1/4

5/16

3/8

1/2

Wire Range

4

4

4

4

4

3M™ Ring Tongues — Nylon Insulated 26-24 AWG



Product Number ^a	UPC (054007-)	Wire Range (AWG)	Stud Size	W	C	L	E	Thickness	Barrel Length	Barrel I.D.	Maximum Insulation Diameter	Terminals per: Carton	Case
MN24-2RK	95136	26-24	2	0.14	0.12	0.47	0.40	0.020	0.13	0.030	0.093	—	1000
MN24-4RX	11318	26-24	4	0.20	0.21	0.60	0.49	0.020	0.14	0.030	0.093	100	500
MN24-4RK	00971	26-24	4	0.20	0.21	0.60	0.49	0.020	0.14	0.030	0.093	—	1000
MN24-6RX	49587	26-24	6	0.20	0.21	0.60	0.49	0.020	0.14	0.030	0.093	100	500
MN24-6RK	00972	26-24	6	0.20	0.21	0.60	0.49	0.020	0.14	0.030	0.093	—	1000
MN24-8RX	49588	26-24	8	0.25	0.28	0.69	0.56	0.020	0.13	0.030	0.093	100	500
MN24-8RK	00973	26-24	8	0.25	0.28	0.69	0.56	0.020	0.13	0.030	0.093	—	1000
MN24-10RX	11321	26-24	10	0.25	0.28	0.69	0.56	0.020	0.13	0.030	0.093	100	500
MN24-10RK	00974	26-24	10	0.25	0.28	0.69	0.56	0.020	0.13	0.030	0.093	—	1000

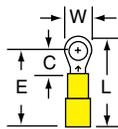

MN24-2R

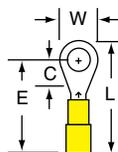

MN24-4R

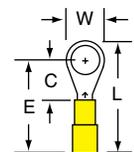

MN24-6R

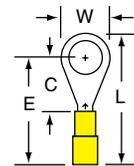

MN24-8R

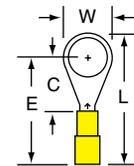

MN24-10R

Stud Size

2

4

6

8

10

Wire Range

26-24

26-24

26-24

26-24

26-24

^aProduct number ending in X = box; product number ending with K = bulk.

3M™ Ring Tongues — Nylon Insulated with Insulation Grip 22-18 AWG



Product Number*	UPC (054007-)	Wire Range (AWG)	Stud Size	W	C	L	E	Thickness	Barrel Length	Barrel I.D.	Maximum Insulation Diameter	Terminals per Carton	Case
MNG18-4R/SX	49595	22-18	4	0.25	0.22	0.79	0.66	0.030	0.25	0.070	0.145	100	500
MNG18-4R/SK	01062	22-18	4	0.25	0.22	0.79	0.66	0.030	0.25	0.070	0.145	—	1000
MNG18-6R/SX	21791	22-18	6	0.25	0.22	0.79	0.66	0.030	0.25	0.070	0.145	100	500
MNG18-6R/SK	16163	22-18	6	0.25	0.22	0.79	0.66	0.030	0.25	0.070	0.145	—	1000
MNG18-8R/LX	21809	22-18	8	0.31	0.33	0.92	0.77	0.030	0.25	0.070	0.145	100	500
MNG18-8R/LK	01069	22-18	8	0.31	0.33	0.92	0.77	0.030	0.25	0.070	0.145	—	1000
MNG18-10R/LX	21817	22-18	10	0.31	0.33	0.92	0.77	0.030	0.25	0.070	0.145	100	500
MNG18-10R/LK	01071	22-18	10	0.31	0.33	0.92	0.77	0.030	0.25	0.070	0.145	—	1000
MNG18-14R/SX	49596	22-18	1/4	0.47	0.40	1.07	0.84	0.030	0.25	0.070	0.145	100	500
MNG18-14R/SK	01072	22-18	1/4	0.47	0.40	1.07	0.84	0.030	0.25	0.070	0.145	—	1000
MNG18-516R/SX	49597	22-18	5/16	0.47	0.40	1.07	0.84	0.030	0.25	0.070	0.145	100	500
MNG18-516R/SK	01074	22-18	5/16	0.47	0.40	1.07	0.84	0.030	0.25	0.070	0.145	—	1000
MNG18-38RX	49598	22-18	3/8	0.56	0.40	1.12	0.84	0.030	0.25	0.070	0.145	100	500
MNG18-38RK	01076	22-18	3/8	0.56	0.40	1.12	0.84	0.030	0.25	0.070	0.145	—	1000

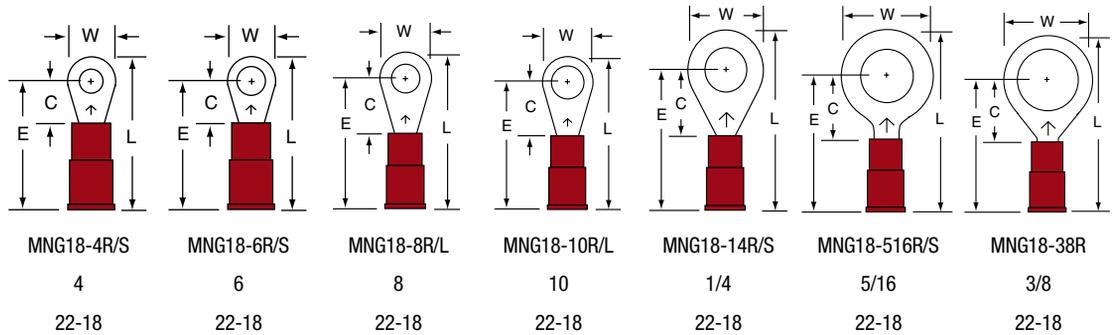

*Product number ending in X = box; product number ending with K = bulk.

3M™ Ring Tongues — Nylon Insulated with Insulation Grip 16-14 AWG



Product Number*	UPC (054007-)	Wire Range (AWG)	Stud Size	W	C	L	E	Thickness	Barrel Length	Barrel I.D.	Maximum Insulation Diameter	Terminals per: Carton	Case
MNG14-4R/SX	49616	16-14	4	0.25	0.22	0.81	0.68	0.030	0.25	0.090	0.170	100	500
MNG14-4R/SK	01428	16-14	4	0.25	0.22	0.81	0.68	0.030	0.25	0.090	0.170	—	1000
MNG14-6R/SX	22468	16-14	6	0.25	0.22	0.81	0.68	0.030	0.25	0.090	0.170	100	500
MNG14-6R/SK	01430	16-14	6	0.25	0.22	0.81	0.68	0.030	0.25	0.090	0.170	—	1000
MNG14-8R/SX	49617	16-14	8	0.25	0.22	0.81	0.68	0.030	0.25	0.090	0.170	100	500
MNG14-8R/SK	01433	16-14	8	0.25	0.22	0.81	0.68	0.030	0.25	0.090	0.170	—	1000
MNG14-8RX	49618	16-14	8	0.33	0.29	0.91	0.75	0.030	0.25	0.090	0.170	100	500
MNG14-8RK	01434	16-14	8	0.33	0.29	0.91	0.75	0.030	0.25	0.090	0.170	—	1000
MNG14-8R/LX	22476	16-14	8	0.31	0.33	0.94	0.79	0.030	0.25	0.090	0.170	100	500
MNG14-8R/LK	01435	16-14	8	0.31	0.33	0.94	0.79	0.030	0.25	0.090	0.170	—	1000
MNG14-10RX	49619	16-14	10	0.33	0.29	0.91	0.75	0.030	0.25	0.090	0.170	100	500
MNG14-10RK	14150	16-14	10	0.33	0.29	0.91	0.75	0.030	0.25	0.090	0.170	—	1000
MNG14-10R/LX	22484	16-14	10	0.31	0.33	0.94	0.79	0.030	0.25	0.090	0.170	100	500
MNG14-10R/LK	01437	16-14	10	0.31	0.33	0.94	0.79	0.030	0.25	0.090	0.170	—	1000
MNG14-14R/SX	22492	16-14	1/4	0.47	0.40	1.09	0.86	0.030	0.25	0.090	0.170	100	500
MNG14-14R/SK	01438	16-14	1/4	0.47	0.40	1.09	0.86	0.030	0.25	0.090	0.170	—	1000
MNG14-516R/SX	49620	16-14	5/16	0.47	0.40	1.09	0.86	0.030	0.25	0.090	0.170	100	500
MNG14-516R/SK	01440	16-14	5/16	0.47	0.40	1.09	0.86	0.030	0.25	0.090	0.170	—	1000
MNG14-38RX	49621	16-14	3/8	0.56	0.40	1.14	0.86	0.030	0.25	0.090	0.170	100	500
MNG14-38RK	01442	16-14	3/8	0.56	0.40	1.14	0.86	0.030	0.25	0.090	0.170	—	1000

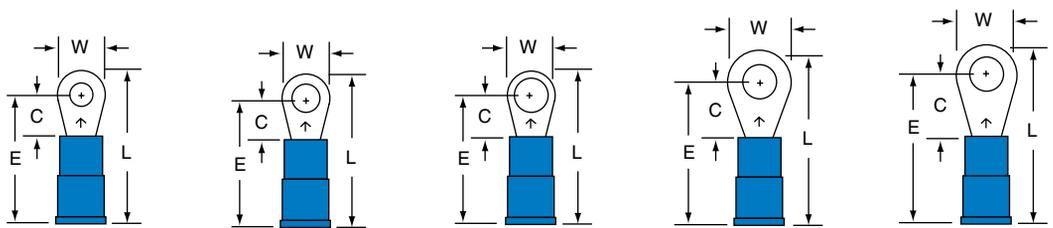

MNG14-4R/S Stud Size 4 Wire Range 16-14
 MNG14-6R/S Stud Size 6 Wire Range 16-14
 MNG14-8R/S Stud Size 8 Wire Range 16-14
 MNG14-8R Stud Size 8 Wire Range 16-14
 MNG14-8R/L Stud Size 8 Wire Range 16-14

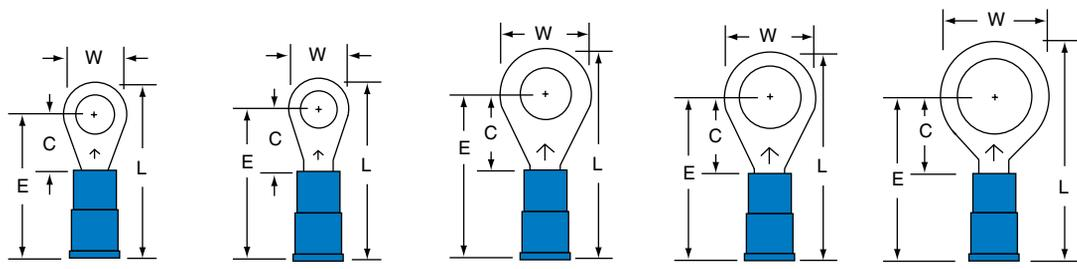

MNG14-10R Stud Size 10 Wire Range 16-14
 MNG14-10R/L Stud Size 10 Wire Range 16-14
 MNG14-14R/S Stud Size 1/4 Wire Range 16-14
 MNG14-516R/S Stud Size 5/16 Wire Range 16-14
 MNG14-38R Stud Size 3/8 Wire Range 16-14

*Product number ending in X = box; product number ending with K = bulk.

3M™ Ring Tongues — Nylon Insulated with Insulation Grip 12-10 AWG



TERMINALS, KITS AND TOOLS • Ring Tongues

Product Number*	UPC (054007-)	Wire Range (AWG)	Stud Size	W	C	L	E	Thickness	Barrel Length	Barrel I.D.	Maximum Insulation Diameter	Terminals per Carton	Case
MNG10-4R/SK	01932	12-10	4	0.28	0.29	0.98	0.84	0.040	0.25	0.135	0.250	—	500
MNG10-6RX	23425	12-10	6	0.38	0.29	1.03	0.84	0.040	0.25	0.135	0.250	50	500
MNG10-6RK	01934	12-10	6	0.38	0.29	1.03	0.84	0.040	0.25	0.135	0.250	—	500
MNG10-8RX	23433	12-10	8	0.38	0.29	1.03	0.84	0.040	0.25	0.135	0.250	50	500
MNG10-8RK	01936	12-10	8	0.38	0.29	1.03	0.84	0.040	0.25	0.135	0.250	—	500
MNG10-10RX	23441	12-10	10	0.38	0.29	1.03	0.84	0.040	0.25	0.135	0.250	50	500
MNG10-10RK	01937	12-10	10	0.38	0.29	1.03	0.84	0.040	0.25	0.135	0.250	—	500
MNG10-14R/SX	23458	12-10	1/4	0.53	0.44	1.26	0.99	0.040	0.25	0.135	0.250	50	500
MNG10-14R/SK	01938	12-10	1/4	0.53	0.44	1.26	0.99	0.040	0.25	0.135	0.250	—	500
MNG10-516R/SX	49640	12-10	5/16	0.53	0.44	1.26	0.99	0.040	0.25	0.135	0.250	50	500
MNG10-516R/SK	01940	12-10	5/16	0.53	0.44	1.26	0.99	0.040	0.25	0.135	0.250	—	500
MNG10-38R/SX	49641	12-10	3/8	0.54	0.44	1.26	0.99	0.040	0.25	0.135	0.250	50	500
MNG10-38R/SK	01942	12-10	3/8	0.54	0.44	1.26	0.99	0.040	0.25	0.135	0.250	—	500

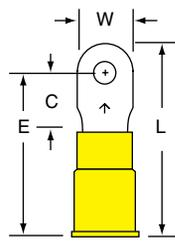

MNG10-4R/S

Stud Size 4
Wire Range 12-10

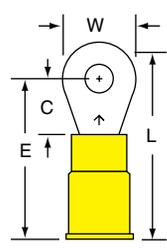

MNG10-6R

Stud Size 6
Wire Range 12-10

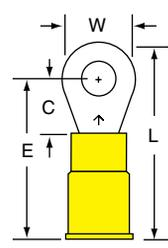

MNG10-8R

Stud Size 8
Wire Range 12-10

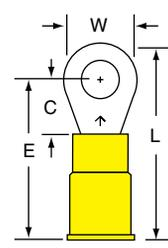

MNG10-10R

Stud Size 10
Wire Range 12-10

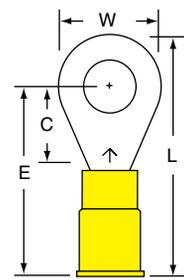

MNG10-14R/S

Stud Size 1/4
Wire Range 12-10

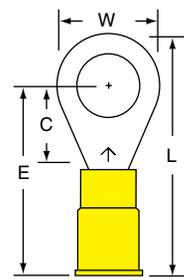

MNG10-516R/S

Stud Size 5/16
Wire Range 12-10

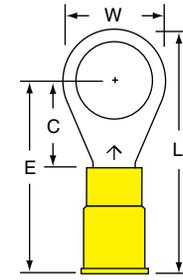

MNG10-38R/S

Stud Size 3/8
Wire Range 12-10

*Product number ending in X = box; product number ending with K = bulk.

3M™ Ring Tongues — Heat Shrink Brazed Seam 22-18 AWG



Product Number ¹	UPC (054007-)	Wire Range (AWG)	Stud Size	W	C	L	E	Thickness	Barrel Length	Barrel I.D.	Terminals per: Carton	Case
MH18-6R/LX	06344	22-18	6	0.31	0.15	1.00	0.84	0.030	0.25	0.070	25	100
MH18-6R/LK	06345	22-18	6	0.31	0.15	1.00	0.84	0.030	0.25	0.070	—	250
MH18-8R/LX	06348	22-18	8	0.31	0.18	1.00	0.84	0.030	0.25	0.070	25	100
MH18-8R/LK	06349	22-18	8	0.31	0.18	1.00	0.84	0.030	0.25	0.070	—	250
MH18-10R/LX	06350	22-18	10	0.31	0.20	1.00	0.84	0.030	0.25	0.070	25	100
MH18-10R/LK	06351	22-18	10	0.31	0.20	1.00	0.84	0.030	0.25	0.070	—	250

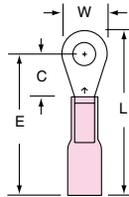

MH18-6R/L

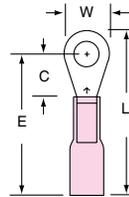

MH18-8R/L

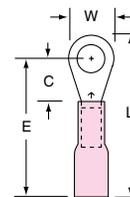

MH18-10R/L

Stud Size

6

8

10

Wire Range

22-18

22-18

22-18

3M™ Ring Tongues — Heat Shrink Brazed Seam 16-14 AWG



Product Number ¹	UPC (054007-)	Wire Range (AWG)	Stud Size	W	C	L	E	Thickness	Barrel Length	Barrel I.D.	Terminals per: Carton	Case
MH14-6R/LX	06320	16-14	6	0.31	0.15	1.00	0.84	0.030	0.25	0.090	25	100
MH14-6R/LK	06321	16-14	6	0.31	0.15	1.00	0.84	0.030	0.25	0.090	—	250
MH14-8R/LX	06324	16-14	8	0.31	0.18	1.00	0.84	0.030	0.25	0.090	25	100
MH14-8R/LK	06325	16-14	8	0.31	0.18	1.00	0.84	0.030	0.25	0.090	—	250
MH14-10R/LX	06326	16-14	10	0.31	0.20	1.00	0.84	0.030	0.25	0.090	25	100
MH14-10R/LK	06327	16-14	10	0.31	0.20	1.00	0.84	0.030	0.25	0.090	—	250
MH14-14R/SX	06330	16-14	1/4	0.47	0.26	1.1	0.86	0.030	0.25	0.090	25	100
MH14-14R/SK	06331	16-14	1/4	0.47	0.26	1.1	0.86	0.030	0.25	0.090	—	250
MH14-516R/SX	06336	16-14	5/16	0.47	0.33	1.1	0.86	0.030	0.25	0.090	25	100
MH14-38RX	06334	16-14	3/8	0.56	0.28	1.1	0.87	0.030	0.25	0.090	25	100
MH14-38RK	06335	16-14	3/8	0.56	0.28	1.1	0.87	0.030	0.25	0.090	—	250

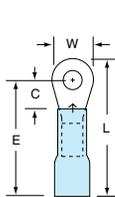

MH14-6R/L

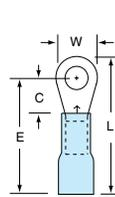

MH14-8R/L

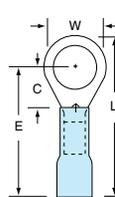

MH14-10R/L

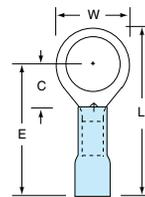

MH14-14R/S

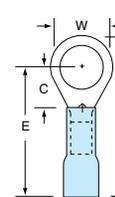

MH14-516R/S

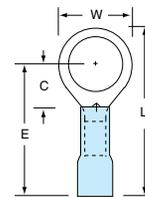

MH14-38R

Stud Size

6

8

10

1/4

5/16

3/8

Wire Range

16-14

16-14

16-14

16-14

16-14

16-14

¹Product number ending in X = box; product number ending with K = bulk.

3M™ Ring Tongues — Heat Shrink Brazed Seam 12-10



Product Number*	UPC (054007-)	Wire Range (AWG)	Stud Size	W	C	L	E	Thickness	Barrel Length	Barrel I.D.	Terminals per: Carton	Case
MH10-8RX	06302	12-10	8	0.38	0.19	1.1	0.91	0.040	0.25	0.135	25	100
MH10-10RX	06305	12-10	10	0.38	0.21	1.1	0.91	0.040	0.25	0.135	25	100
MH10-10RK	06306	12-10	10	0.38	0.21	1.1	0.91	0.040	0.25	0.135	—	250
MH10-14RX	06309	12-10	1/4	0.59	0.29	1.2	0.90	0.040	0.25	0.135	25	100
MH10-14RK	06359	12-10	1/4	0.59	0.29	1.2	0.90	0.040	0.25	0.135	—	250
MH10-38RX	06312	12-10	3/8	0.59	0.29	1.2	0.90	0.040	0.25	0.135	25	100
MH10-38RK	06313	12-10	3/8	0.59	0.29	1.2	0.90	0.040	0.25	0.135	—	250

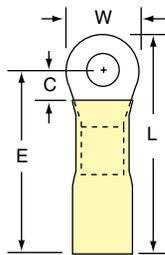

MH10-8R

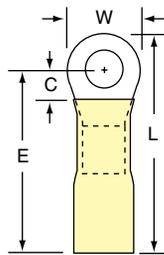

MH10-10R

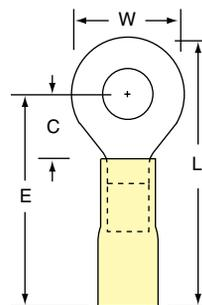

MH10-14R

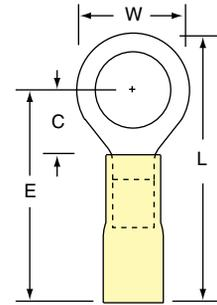

MH10-38R

Stud Size

8

10

1/4

3/8

Wire Range

12-10

12-10

12-10

12-10

*Product number ending in X = box; product number ending with K = bulk.

Multi-Stud Ring Tongues

3M™ Multi-Stud Ring Tongues — Vinyl Insulated Brazed Seam



Product Number*	UPC (054007-)	Wire Range (AWG)	Stud Size	W	C	L	E	Thickness	Barrel Length	Barrel I.D.	Maximum Insulation Diameter	Terminals per: Carton	Case
MV18-610RX	14093	22-18	6/8/10	0.34	0.31	1.01	0.76	0.030	0.25	0.070	0.145	100	500
MV18-610RK	01342	22-18	6/8/10	0.34	0.31	1.01	0.76	0.030	0.25	0.070	0.145	—	1000
MV14-610RX	14119	16-14	6/8/10	0.34	0.31	1.01	0.76	0.030	0.25	0.090	0.170	100	500
MV14-610RK	01851	16-14	6/8/10	0.34	0.31	1.01	0.76	0.030	0.25	0.090	0.170	—	1000
MV10-610RX	14127	12-10	6/8/10	0.39	0.35	1.19	0.80	0.040	0.25	0.135	0.250	50	500
MV10-610RK	02099	12-10	6/8/10	0.39	0.35	1.19	0.80	0.040	0.25	0.135	0.250	—	500

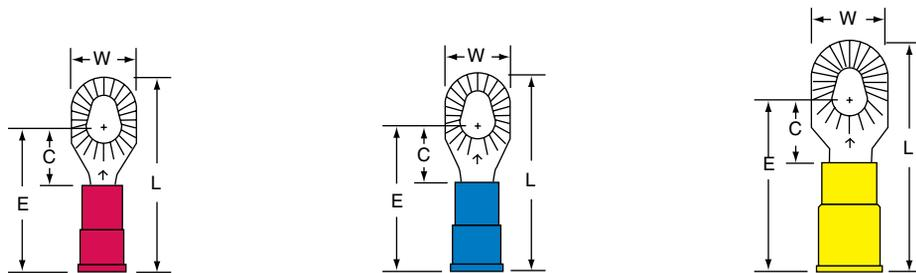

MV18-610R

MV14-610R

MV10-610R

Stud Size

6/8/10

6/8/10

6/8/10

Wire Range

22-18

16-14

12-10

3M™ Multi-Stud Ring Tongues — Nylon Insulated with Insulation Grip



Product Number*	UPC (054007-)	Wire Range (AWG)	Stud Size	W	C	L	E	Thickness	Barrel Length	Barrel I.D.	Maximum Insulation Diameter	Terminals per: Carton	Case
MNG18-610RX	49611	22-18	6/8/10	0.34	0.31	1.00	0.75	0.030	0.25	0.070	0.145	100	500
MNG18-610RK	01344	22-18	6/8/10	0.34	0.31	1.00	0.75	0.030	0.25	0.070	0.145	—	1000
MNG14-610RX	49636	16-14	6/8/10	0.34	0.31	1.02	0.77	0.030	0.25	0.090	0.170	100	500
MNG14-610RK	01853	16-14	6/8/10	0.34	0.31	1.02	0.77	0.030	0.25	0.090	0.170	—	1000
MNG10-610RX	49646	12-10	6/8/10	0.39	0.35	1.19	0.80	0.040	0.25	0.135	0.250	50	100
MNG10-610RK	02100	12-10	6/8/10	0.39	0.35	1.19	0.80	0.040	0.25	0.135	0.250	—	500

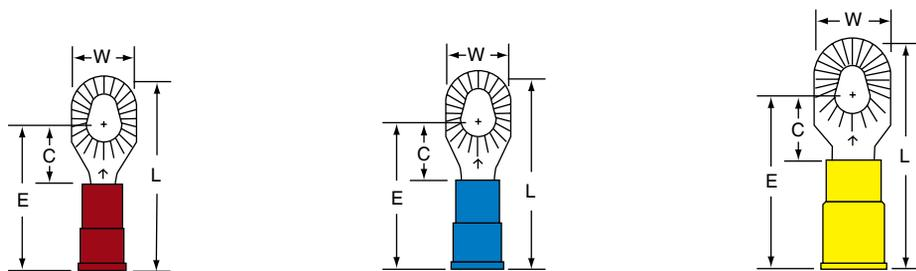

MNG18-610R

MNG14-610R

MNG10-610R

Stud Size

6/8/10

6/8/10

6/8/10

Wire Range

22-18

16-14

12-10

*Product number ending in X = box; product number ending with K = bulk.

Standard Forks

3M™ Standard Forks — Non-Insulated Brazed Seam



Product Number	UPC (054007-)	Wire Range (AWG)	Stud Size	W	C	L	E	Thickness	Barrel Length	Barrel I.D.	Terminals per: Carton	Case
M18-6FX	21858	22-18	6	0.34	0.29	0.70	0.54	0.030	0.25	0.070	100	500
M18-6FK	01150	22-18	6	0.34	0.29	0.70	0.54	0.030	0.25	0.070	—	1000
M18-8FX	21866	22-18	8	0.34	0.29	0.70	0.54	0.030	0.25	0.070	100	500
M18-8FK	01152	22-18	8	0.34	0.29	0.70	0.54	0.030	0.25	0.070	—	1000
M18-10FX	49599	22-18	10	0.34	0.29	0.70	0.54	0.030	0.25	0.070	100	500
M18-10FK	01154	22-18	10	0.34	0.29	0.70	0.54	0.030	0.25	0.070	—	1000
M14-6FX	49622	16-14	6	0.34	0.29	0.70	0.54	0.030	0.25	0.090	100	500
M14-6FK	01516	16-14	6	0.34	0.29	0.70	0.54	0.030	0.25	0.090	—	1000
M14-8FX	01518	16-14	8	0.34	0.29	0.70	0.54	0.030	0.25	0.090	—	1000
M14-10FX	22542	16-14	10	0.34	0.29	0.70	0.54	0.030	0.25	0.090	100	500
M14-10FK	01520	16-14	10	0.34	0.29	0.70	0.54	0.030	0.25	0.090	—	1000
M10-6FK	01972	12-10	6	0.38	0.29	0.73	0.54	0.040	0.25	0.135	—	500
M10-8FX	23581	12-10	8	0.38	0.29	0.73	0.54	0.040	0.25	0.135	50	500
M10-8FK	01973	12-10	8	0.38	0.29	0.73	0.54	0.040	0.25	0.135	—	500
M10-10FX	23599	12-10	10	0.38	0.29	0.73	0.54	0.040	0.25	0.135	50	500
M10-10FK	01974	12-10	10	0.38	0.29	0.73	0.54	0.040	0.25	0.135	—	500

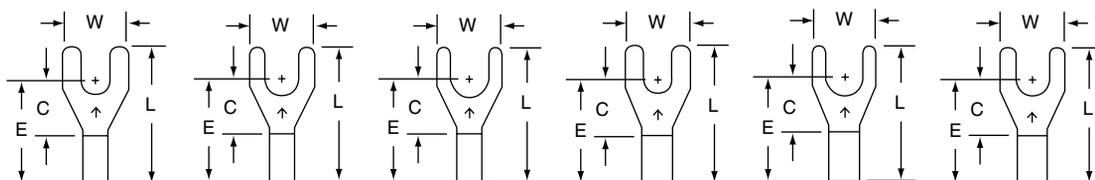

M18-6F M18-8F M18-10F M14-6F M14-8F M14-10F

Stud Size	6	8	10	6	8	10
Wire Range	22-18	22-18	22-18	16-14	16-14	16-14

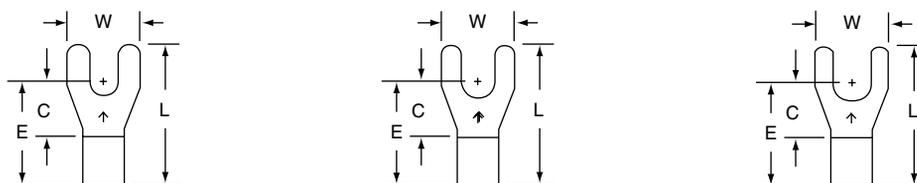

M10-6F M10-8F M10-10F

Stud Size	6	8	10
Wire Range	12-10	12-10	12-10

*Product number ending in X = box; product number ending with K = bulk.

3M™ Standard Forks — Non-Insulated Butted Seam



Product Number*	UPC (054007-)	Wire Range (AWG)	Stud Size	W	C	L	E	Thickness	Barrel Length	Barrel I.D.	Maximum Insulation Diameter	Terminals per Case
MU18-6FK	01144	22-18	6	0.34	0.29	0.70	0.54	0.030	0.25	0.070	1000	
MU18-8FK	01146	22-18	8	0.34	0.29	0.70	0.54	0.030	0.25	0.070	1000	
MU14-8FK	01512	16-14	8	0.34	0.29	0.70	0.54	0.030	0.25	0.090	1000	
MU14-10FK	01514	16-14	10	0.34	0.29	0.70	0.54	0.030	0.25	0.090	1000	
MU10-8FK	01970	12-10	8	0.38	0.29	0.73	0.54	0.040	0.25	0.135	500	
MU10-10FK	01971	12-10	10	0.38	0.29	0.73	0.54	0.040	0.25	0.135	500	

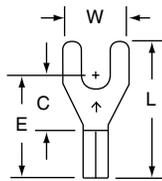

MU18-6F

Stud Size

6

Wire Range

22-18

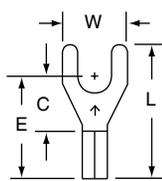

MU18-8F

8

22-18

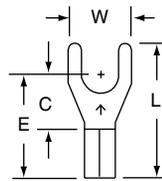

MU14-8F

8

16-14

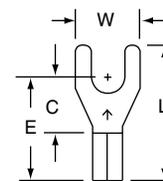

MU14-10F

10

16-14

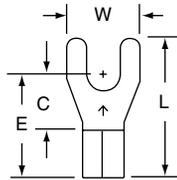

MU10-8F

Stud Size

8

Wire Range

12-10

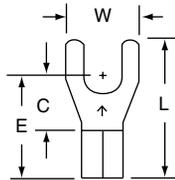

MU10-10F

10

12-10

*Product number ending in X = box; product number ending with K = bulk.

3M™ Standard Forks — Vinyl Insulated Brazed Seam



Product Number*	UPC (054007-)	Wire Range (AWG)	Stud Size	W	C	L	E	Thickness	Barrel Length	Barrel I.D.	Maximum Insulation Diameter	Terminals per: Carton	Case
MV18-6FX	21882	22-18	6	0.34	0.29	0.90	0.74	0.030	0.25	0.070	0.145	100	500
MV18-6FK	01162	22-18	6	0.34	0.29	0.90	0.74	0.030	0.25	0.070	0.145	—	1000
MV18-8FX	21890	22-18	8	0.34	0.29	0.90	0.74	0.030	0.25	0.070	0.145	100	500
MV18-8FK	01164	22-18	8	0.34	0.29	0.90	0.74	0.030	0.25	0.070	0.145	—	1000
MV18-10FX	21908	22-18	10	0.34	0.29	0.90	0.74	0.030	0.25	0.070	0.145	100	500
MV18-10FK	01166	22-18	10	0.34	0.29	0.90	0.74	0.030	0.25	0.070	0.145	—	1000
MV14-6FX	22559	16-14	6	0.34	0.29	0.90	0.74	0.030	0.25	0.090	0.170	100	500
MV14-6FK	01528	16-14	6	0.34	0.29	0.90	0.74	0.030	0.25	0.090	0.170	—	1000
MV14-8FX	22567	16-14	8	0.34	0.29	0.90	0.74	0.030	0.25	0.090	0.170	100	500
MV14-8FK	01530	16-14	8	0.34	0.29	0.90	0.74	0.030	0.25	0.090	0.170	—	1000
MV14-10FX	22575	16-14	10	0.34	0.29	0.90	0.74	0.030	0.25	0.090	0.170	100	500
MV14-10FK	01532	16-14	10	0.34	0.29	0.90	0.74	0.030	0.25	0.090	0.170	—	1000
MV10-6FX	23607	12-10	6	0.38	0.29	1.03	0.84	0.040	0.25	0.135	0.250	50	500
MV10-6FK	01978	12-10	6	0.38	0.29	1.03	0.84	0.040	0.25	0.135	0.250	—	500
MV10-8FX	23615	12-10	8	0.38	0.29	1.03	0.84	0.040	0.25	0.135	0.250	50	500
MV10-8FK	01979	12-10	8	0.38	0.29	1.03	0.84	0.040	0.25	0.135	0.250	—	500
MV10-10FX	23623	12-10	10	0.38	0.29	1.03	0.84	0.040	0.25	0.135	0.250	50	500
MV10-10FK	01980	12-10	10	0.38	0.29	1.03	0.84	0.040	0.25	0.135	0.250	—	500

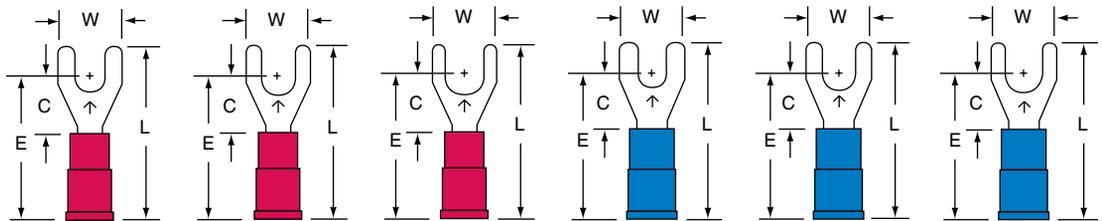

MV18-6F MV18-8F MV18-10F MV14-6F MV14-8F MV14-10F

Stud Size 6 8 10 6 8 10
 Wire Range 22-18 22-18 22-18 16-14 16-14 16-14

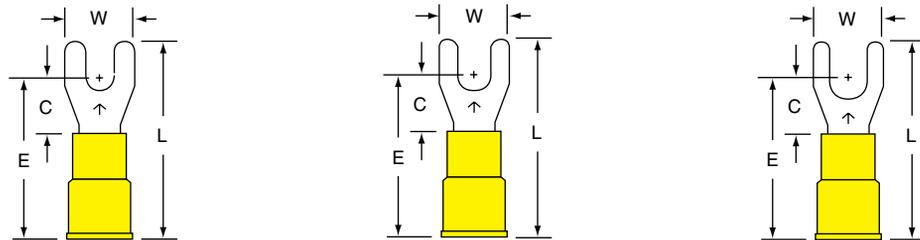

MV10-6F MV10-8F MV10-10F

Stud Size 6 8 10
 Wire Range 12-10 12-10 12-10

*Product number ending in X = box; product number ending with K = bulk.

3M™ Standard Forks — Vinyl Insulated Butted Seam



Product Number*	UPC (054007-)	Wire Range (AWG)	Stud Size	W	C	L	E	Thickness	Barrel Length	Barrel I.D.	Maximum Insulation Diameter	Terminals per: Carton Case
MVU18-6FK	01174	22-18	6	0.34	0.29	0.90	0.74	0.030	0.25	0.070	0.145	1000
MVU18-8FK	01176	22-18	8	0.34	0.29	0.90	0.74	0.030	0.25	0.070	0.145	1000
MVU18-10FK	01178	22-18	10	0.34	0.29	0.90	0.74	0.030	0.25	0.070	0.145	1000
MVU14-6FK	01540	16-14	6	0.34	0.29	0.90	0.74	0.030	0.25	0.090	0.170	1000
MVU14-8FK	01542	16-14	8	0.34	0.29	0.90	0.74	0.030	0.25	0.090	0.170	1000
MVU14-10FK	01544	16-14	10	0.34	0.29	0.90	0.74	0.030	0.25	0.090	0.170	1000
MVU10-6FK	01984	12-10	6	0.38	0.29	1.03	0.84	0.040	0.25	0.135	0.250	500
MVU10-8FK	01985	12-10	8	0.38	0.29	1.03	0.84	0.040	0.25	0.135	0.250	500
MVU10-10FK	01986	12-10	10	0.38	0.29	1.03	0.84	0.040	0.25	0.135	0.250	500

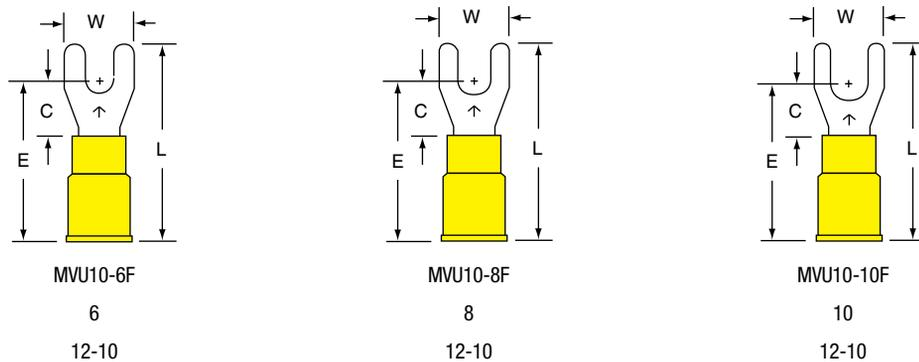
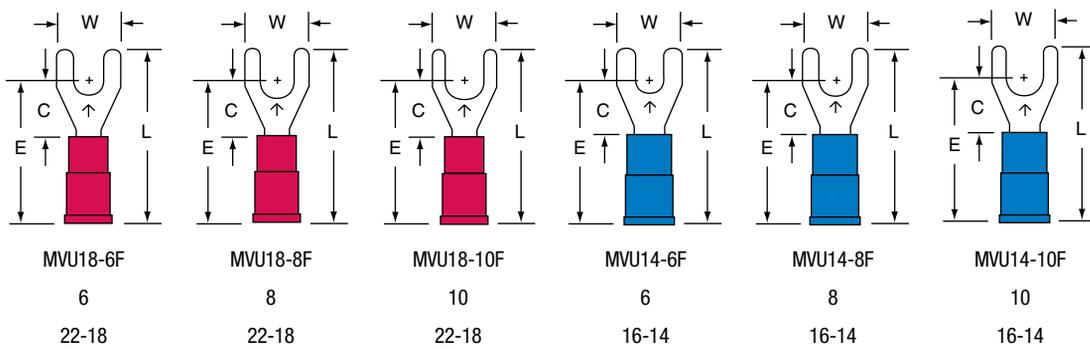

*Product number ending in X = box; product number ending with K = bulk.

3M™ Standard Forks — Nylon Insulated with Insulation Grip



Product Number*	UPC (054007-)	Wire Range (AWG)	Stud Size	W	C	L	E	Thickness	Barrel Length	Barrel I.D.	Maximum Insulation Diameter	Terminals per Carton	Case
MNG18-6FX	21916	22-18	6	0.34	0.29	0.89	0.73	0.030	0.25	0.070	0.145	100	500
MNG18-6FK	01168	22-18	6	0.34	0.29	0.89	0.73	0.030	0.25	0.070	0.145	—	1000
MNG18-8FX	21924	22-18	8	0.34	0.29	0.89	0.73	0.030	0.25	0.070	0.145	100	500
MNG18-8FK	01170	22-18	8	0.34	0.29	0.89	0.73	0.030	0.25	0.070	0.145	—	1000
MNG18-10FK	01172	22-18	10	0.34	0.29	0.89	0.73	0.030	0.25	0.070	0.145	—	1000
MNG14-6FX	22583	16-14	6	0.34	0.29	0.91	0.75	0.030	0.25	0.090	0.170	100	500
MNG14-6FK	01534	16-14	6	0.34	0.29	0.91	0.75	0.030	0.25	0.090	0.170	—	1000
MNG14-8FX	22591	16-14	8	0.34	0.29	0.91	0.75	0.030	0.25	0.090	0.170	100	500
MNG14-8FK	01536	16-14	8	0.34	0.29	0.91	0.75	0.030	0.25	0.090	0.170	—	1000
MNG14-10FX	22609	16-14	10	0.34	0.29	0.91	0.75	0.030	0.25	0.090	0.170	100	500
MNG14-10FK	01538	16-14	10	0.34	0.29	0.91	0.75	0.030	0.25	0.090	0.170	—	1000
MNG10-6FK	01981	12-10	6	0.38	0.29	1.03	0.84	0.040	0.25	0.135	0.250	—	500
MNG10-8FX	23649	12-10	8	0.38	0.29	1.03	0.84	0.040	0.25	0.135	0.250	50	500
MNG10-8FK	01982	12-10	8	0.38	0.29	1.03	0.84	0.040	0.25	0.135	0.250	—	500
MNG10-10FX	23656	12-10	10	0.38	0.29	1.03	0.84	0.040	0.25	0.135	0.250	50	500
MNG10-10FK	01983	12-10	10	0.38	0.29	1.03	0.84	0.040	0.25	0.135	0.250	—	500

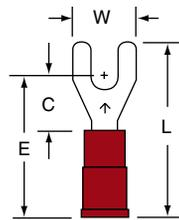

MNG18-6F

Stud Size

6

Wire Range

22-18

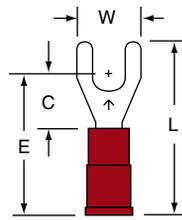

MNG18-8F

8

22-18

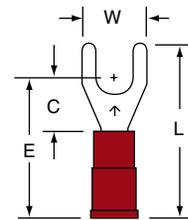

MNG18-10F

10

22-18

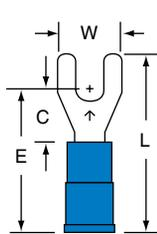

MNG14-6F

Stud Size

6

Wire Range

16-14

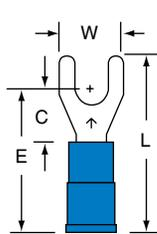

MNG14-8F

8

16-14

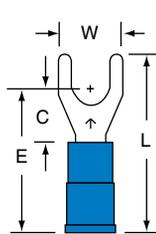

MNG14-10F

10

16-14

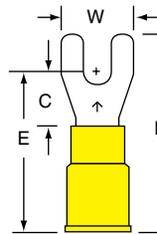

MNG10-6F

6

12-10

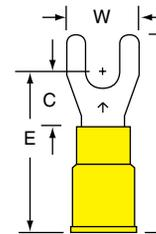

MNG10-8F

8

12-10

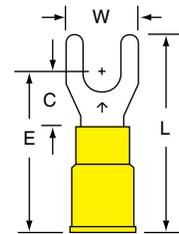

MNG10-10F

10

12-10

*Product number ending in X = box; product number ending with K = bulk.

3M™ Standard Forks — Nylon Insulated

Product Number*	UPC (054007-)	Wire Range (AWG)	Stud Size	W	C	L	E	Thickness	Barrel Length	Barrel I.D.	Maximum Insulation Diameter	Terminals per: Carton	Case
MN24-4FX*	95166	26-24	4	0.20	0.21	0.61	0.49	0.020	0.14	0.030	0.093	100	500
MN24-4FK*	95165	26-24	4	0.20	0.21	0.61	0.49	0.020	0.14	0.030	0.093	—	1000
MN24-6FX*	95172	26-24	6	0.25	0.28	0.69	0.56	0.020	0.13	0.030	0.093	100	500
MN24-6FK*	95171	26-24	6	0.25	0.28	0.69	0.56	0.020	0.13	0.030	0.093	—	1000

* Not UL Listed or CSA Certified

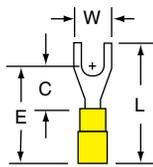

MN24-4F

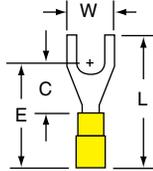

MN24-6F

Stud Size

4

6

Wire Range

26-24

26-24

*Product number ending in X = box; product number ending with K = bulk.

Block Forks

3M™ Block Forks — Non-Insulated Brazed Seam 22-18 AWG



Product Number ¹	UPC (054007-)	Wire Range (AWG)	Stud Size	W	C	L	E	Thickness	Barrel Length	Barrel I.D.	Terminals per Carton	Terminals per Case
M18-4FB/SK	02248	22-18	4	0.25	0.25	0.65	0.50	0.030	0.25	0.070	—	1000
M18-6FB/SX	49600	22-18	6	0.25	0.25	0.65	0.50	0.030	0.25	0.070	100	500
M18-6FB/SK	01202	22-18	6	0.25	0.25	0.65	0.50	0.030	0.25	0.070	—	1000
M18-6FBX	21940	22-18	6	0.30	0.25	0.65	0.50	0.030	0.25	0.070	100	500
M18-6FBK	01203	22-18	6	0.30	0.25	0.65	0.50	0.030	0.25	0.070	—	1000
M18-8FBX	21957	22-18	8	0.30	0.25	0.65	0.50	0.030	0.25	0.070	100	500
M18-8FBK	01204	22-18	8	0.30	0.25	0.65	0.50	0.030	0.25	0.070	—	1000
M18-10FBX	49601	22-18	10	0.30	0.25	0.65	0.50	0.030	0.25	0.070	100	500
M18-10FBK	01205	22-18	10	0.30	0.25	0.65	0.50	0.030	0.25	0.070	—	1000

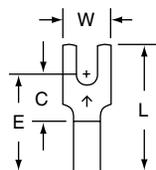

M18-4FB/S

Stud Size

4

Wire Range

22-18

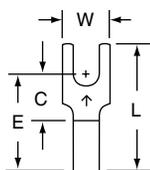

M18-6FB/S

6

22-18

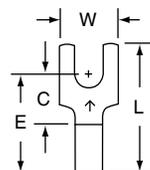

M18-6FB

6

22-18

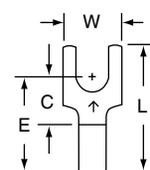

M18-8FB

8

22-18

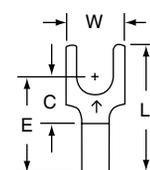

M18-10FB

10

22-18

3M™ Block Forks — Non-Insulated Brazed Seam 16-14 AWG



Product Number ¹	UPC (054007-)	Wire Range (AWG)	Stud Size	W	C	L	E	Thickness	Barrel Length	Barrel I.D.	Terminals per Carton	Terminals per Case
M14-6FB/SX	49623	16-14	6	0.25	0.25	0.65	0.50	0.030	0.25	0.090	100	500
M14-6FB/SK	01568	16-14	6	0.25	0.25	0.65	0.50	0.030	0.25	0.090	—	1000
M14-6FBX	22617	16-14	6	0.30	0.25	0.65	0.50	0.030	0.25	0.090	100	500
M14-6FBK	01569	16-14	6	0.30	0.25	0.65	0.50	0.030	0.25	0.090	—	1000
M14-8FBX	22625	16-14	8	0.30	0.25	0.65	0.50	0.030	0.25	0.090	100	500
M14-8FBK	01570	16-14	8	0.30	0.25	0.65	0.50	0.030	0.25	0.090	—	1000
M14-10FBX	22633	16-14	10	0.30	0.25	0.65	0.50	0.030	0.25	0.090	100	500
M14-10FBK	01571	16-14	10	0.30	0.25	0.65	0.50	0.030	0.25	0.090	—	1000

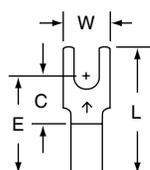

M14-6FB/S

Stud Size

6

Wire Range

16-14

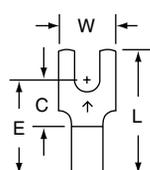

M14-6FB

6

16-14

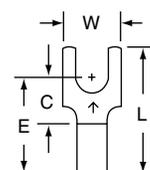

M14-8FB

8

16-14

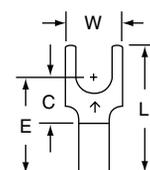

M14-10FB

10

16-14

¹Product number ending in X = box; product number ending with K = bulk.

3M™ Block Forks — Non-Insulated Brazed Seam 12-10 AWG



Product Number ¹	UPC (054007-)	Wire Range (AWG)	Stud Size	W	C	L	E	Thickness	Barrel Length	Barrel I.D.	Terminals per Carton	Case
M10-6FBK	02008	12-10	6	0.32	0.29	0.73	0.54	0.040	0.25	0.135	—	500
M10-8FBX	23672	12-10	8	0.32	0.29	0.73	0.54	0.040	0.25	0.135	50	500
M10-8FBK	02009	12-10	8	0.32	0.29	0.73	0.54	0.040	0.25	0.135	—	500
M10-10FBX	23680	12-10	10	0.32	0.29	0.73	0.54	0.040	0.25	0.135	50	500
M10-10FBK	02010	12-10	10	0.32	0.29	0.73	0.54	0.040	0.25	0.135	—	500

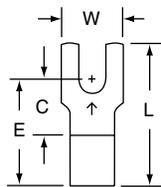

M10-6FB
6
12-10

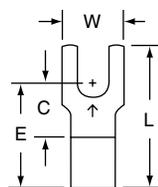

M10-8FB
8
12-10

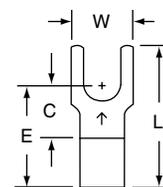

M10-10FB
10
12-10

Stud Size
Wire Range

3M™ Block Forks — Non-Insulated Butted Seam 22-18 AWG



Product Number ¹	UPC (054007-)	Wire Range (AWG)	Stud Size	W	C	L	E	Thickness	Barrel Length	Barrel I.D.	Terminals per Case
MU18-4FB/SK	02263	22-18	4	0.25	0.25	0.65	0.50	0.030	0.25	0.070	1000
MU18-6FB/SK	01198	22-18	6	0.25	0.25	0.65	0.50	0.030	0.25	0.070	1000
MU18-6FBK	01199	22-18	6	0.30	0.25	0.65	0.50	0.030	0.25	0.070	1000
MU18-8FBK	01200	22-18	8	0.30	0.25	0.65	0.50	0.030	0.25	0.070	1000
MU18-10FBK	01201	22-18	10	0.30	0.25	0.65	0.50	0.030	0.25	0.070	1000

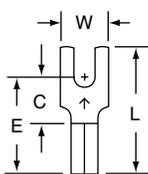

MU18-4FB/S
4
22-18

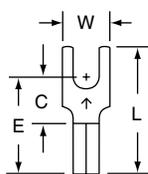

MU18-6FB/S
6
22-18

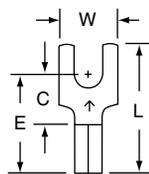

MU18-6FB
6
22-18

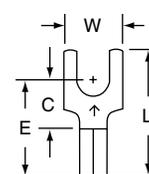

MU18-8FB
8
22-18

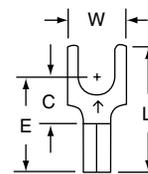

MU18-10FB
10
22-18

Stud Size
Wire Range

¹Product number ending in X = box; product number ending with K = bulk.

3M™ Block Forks — Non-Insulated Butted Seam 16-14 AWG



Product Number*	UPC (054007-)	Wire Range (AWG)	Stud Size	W	C	L	E	Thickness	Barrel Length	Barrel I.D.	Terminals per Case
MU14-4FB/SK	02264	16-14	4	0.25	0.25	0.65	0.50	0.030	0.25	0.090	1000
MU14-6FB/SK	01564	16-14	6	0.25	0.25	0.65	0.50	0.030	0.25	0.090	1000
MU14-6FBK	01565	16-14	6	0.30	0.25	0.65	0.50	0.030	0.25	0.090	1000
MU14-8FBK	01566	16-14	8	0.30	0.25	0.65	0.50	0.030	0.25	0.090	1000
MU14-10FBK	01567	16-14	10	0.30	0.25	0.65	0.50	0.030	0.25	0.090	1000

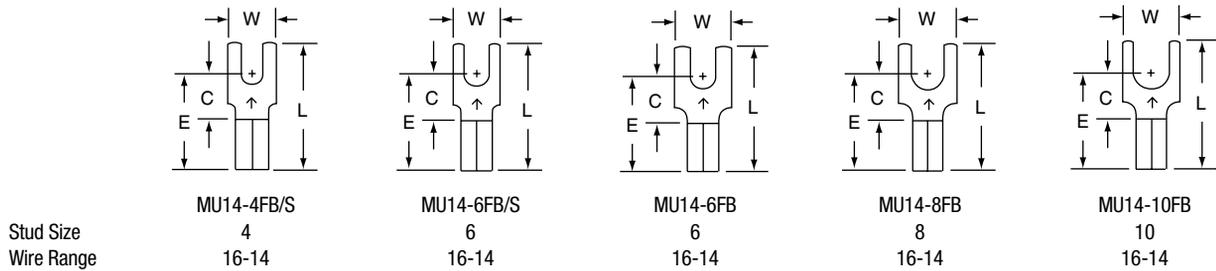

*Product number ending in X = box; product number ending with K = bulk.

3M™ Block Forks — Non-Insulated Butted Seam 12-10 AWG



Product Number ^a	UPC (054007-)	Wire Range (AWG)	Stud Size	W	C	L	E	Thickness	Barrel Length	Barrel I.D.	Terminals per Case
MU10-6FBK	02005	12-10	6	0.32	0.29	0.73	0.54	0.040	0.25	0.135	500
MU10-8FBK	02006	12-10	8	0.32	0.29	0.73	0.54	0.040	0.25	0.135	500
MU10-10FBK	02007	12-10	10	0.32	0.29	0.73	0.54	0.040	0.25	0.135	500

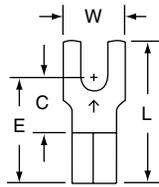

MU10-6FB

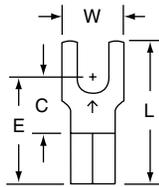

MU10-8FB

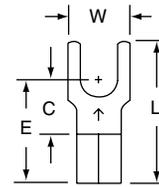

MU10-10FB

Stud Size

6

8

10

Wire Range

12-10

12-10

12-10

3M™ Block Forks — Vinyl Insulated Brazed Seam 22-18 AWG



Product Number ^a	UPC (054007-)	Wire Range (AWG)	Stud Size	W	C	L	E	Thickness	Barrel Length	Barrel I.D.	Maximum Insulation Diameter	Terminals per Carton	Case
MV18-4FB/SK	02279	22-18	4	0.25	0.25	0.85	0.70	0.030	0.25	0.070	0.145	—	1000
MV18-6FB/SX	49602	22-18	6	0.25	0.25	0.85	0.70	0.030	0.25	0.070	0.145	100	500
MV18-6FB/SK	01210	22-18	6	0.25	0.25	0.85	0.70	0.030	0.25	0.070	0.145	—	1000
MV18-6FBX	21973	22-18	6	0.30	0.25	0.85	0.70	0.030	0.25	0.070	0.145	100	500
MV18-6FBK	01211	22-18	6	0.30	0.25	0.85	0.70	0.030	0.25	0.070	0.145	—	1000
MV18-8FBX	21999	22-18	8	0.30	0.25	0.85	0.70	0.030	0.25	0.070	0.145	100	500
MV18-8FBK	01212	22-18	8	0.30	0.25	0.85	0.70	0.030	0.25	0.070	0.145	—	1000
MV18-10FBX	22005	22-18	10	0.30	0.25	0.85	0.70	0.030	0.25	0.070	0.145	100	500
MV18-10FBK	01213	22-18	10	0.30	0.25	0.85	0.70	0.030	0.25	0.070	0.145	—	1000

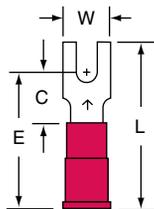

MV18-4FB/S

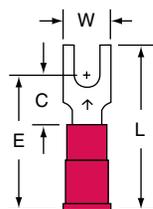

MV18-6FB/S

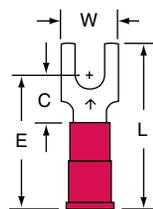

MV18-6FB

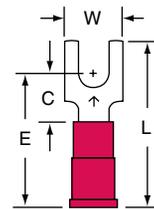

MV18-8FB

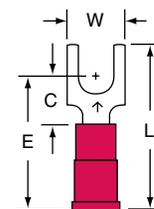

MV18-10FB

Stud Size

4

6

6

8

10

Wire Range

22-18

22-18

22-18

22-18

22-18

^aProduct number ending in X = box; product number ending with K = bulk.

3M™ Block Forks — Vinyl Insulated Brazed Seam 16-14 AWG



Product Number*	UPC (054007-)	Wire Range (AWG)	Stud Size	W	C	L	E	Thickness	Barrel Length	Barrel I.D.	Maximum Insulation Diameter	Terminals per Carton	Case
MV14-4FB/SK	02280	16-14	4	0.25	0.25	0.85	0.70	0.030	0.25	0.090	0.170	—	1000
MV14-6FB/SX	49624	16-14	6	0.25	0.25	0.85	0.70	0.030	0.25	0.090	0.170	100	500
MV14-6FB/SK	01576	16-14	6	0.25	0.25	0.85	0.70	0.030	0.25	0.090	0.170	—	1000
MV14-6FBX	22641	16-14	6	0.30	0.25	0.85	0.70	0.030	0.25	0.090	0.170	100	500
MV14-6FBK	01577	16-14	6	0.30	0.25	0.85	0.70	0.030	0.25	0.090	0.170	—	1000
MV14-8FBX	22658	16-14	8	0.30	0.25	0.85	0.70	0.030	0.25	0.090	0.170	100	500
MV14-8FBK	01578	16-14	8	0.30	0.25	0.85	0.70	0.030	0.25	0.090	0.170	—	1000
MV14-10FBX	22666	16-14	10	0.30	0.25	0.85	0.70	0.030	0.25	0.090	0.170	100	500
MV14-10FBK	01579	16-14	10	0.30	0.25	0.85	0.70	0.030	0.25	0.090	0.170	—	1000

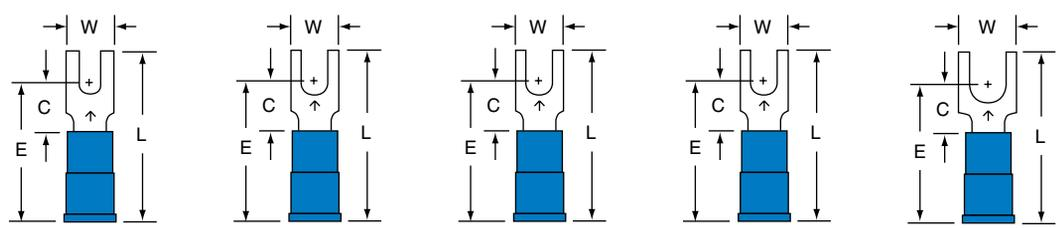

	MV14-4FB/S	MV14-6FB/S	MV14-6FB	MV14-8FB	MV14-10FB
Stud Size	4	6	6	8	10
Wire Range	16-14	16-14	16-14	16-14	16-14

3M™ Block Forks — Vinyl Insulated Brazed Seam 12-10 AWG



Product Number*	UPC (054007-)	Wire Range (AWG)	Stud Size	W	C	L	E	Thickness	Barrel Length	Barrel I.D.	Maximum Insulation Diameter	Terminals per Carton	Case
MV10-6FBX	23698	12-10	6	0.32	0.29	1.03	0.84	0.040	0.25	0.135	0.250	50	500
MV10-6FBK	02014	12-10	6	0.32	0.29	1.03	0.84	0.040	0.25	0.135	0.250	—	500
MV10-8FBX	23706	12-10	8	0.32	0.29	1.03	0.84	0.040	0.25	0.135	0.250	50	500
MV10-8FBK	02015	12-10	8	0.32	0.29	1.03	0.84	0.040	0.25	0.135	0.250	—	500
MV10-10FBX	23714	12-10	10	0.32	0.29	1.03	0.84	0.040	0.25	0.135	0.250	50	500
MV10-10FBK	02016	12-10	10	0.32	0.29	1.03	0.84	0.040	0.25	0.135	0.250	—	500

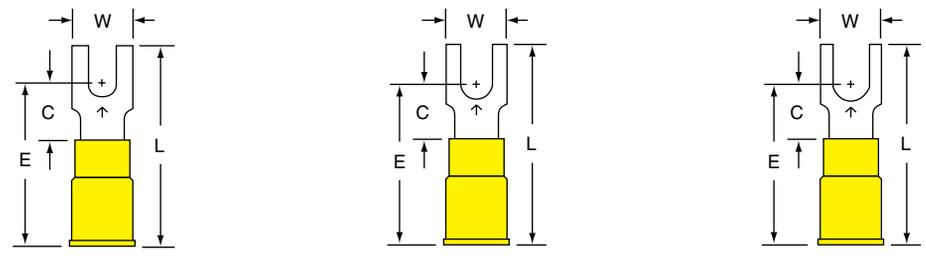

	MV10-6FB	MV10-8FB	MV10-10FB
Stud Size	6	8	10
Wire Range	12-10	12-10	12-10

*Product number ending in X = box; product number ending with K = bulk.

3M™ Block Forks — Vinyl Insulated Butted Seam 22-18 AWG



Product Number ¹	UPC (054007-)	Wire Range (AWG)	Stud Size	W	C	L	E	Thickness	Barrel Length	Barrel I.D.	Maximum Insulation Diameter	Terminals per Case
MVU18-4FB/SK	02253	22-18	4	0.25	0.25	0.85	0.70	0.030	0.25	0.070	0.145	1000
MVU18-6FB/SK	01218	22-18	6	0.25	0.25	0.85	0.70	0.030	0.25	0.070	0.145	1000
MVU18-6FBK	01219	22-18	6	0.30	0.25	0.85	0.70	0.030	0.25	0.070	0.145	1000
MVU18-8FBK	01220	22-18	8	0.30	0.25	0.85	0.70	0.030	0.25	0.070	0.145	1000
MVU18-10FBK	01221	22-18	10	0.30	0.25	0.85	0.70	0.030	0.25	0.070	0.145	1000

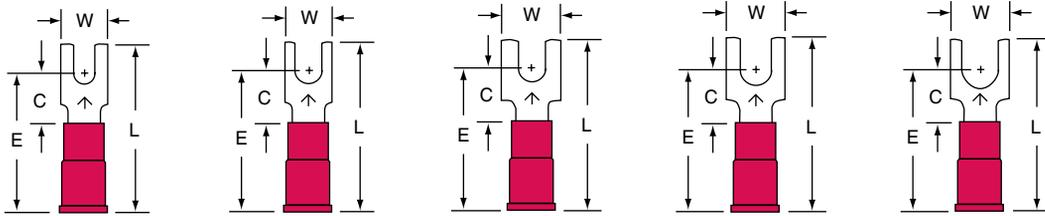

MVU18-4FB/S

MVU18-6FB/S

MVU18-6FB

MVU18-8FB

MVU18-10FB

Stud Size

4

6

6

8

10

Wire Range

22-18

22-18

22-18

22-18

22-18

3M™ Block Forks — Vinyl Insulated Butted Seam 16-14 AWG



Product Number ¹	UPC (054007-)	Wire Range (AWG)	Stud Size	W	C	L	E	Thickness	Barrel Length	Barrel I.D.	Maximum Insulation Diameter	Terminals per Case
MVU14-4FB/SK	02258	16-14	4	0.25	0.25	0.85	0.70	0.030	0.25	0.090	0.170	1000
MVU14-6FB/SK	01584	16-14	6	0.25	0.25	0.85	0.70	0.030	0.25	0.090	0.170	1000
MVU14-6FBK	01585	16-14	6	0.30	0.25	0.85	0.70	0.030	0.25	0.090	0.170	1000
MVU14-8FBK	01586	16-14	8	0.30	0.25	0.85	0.70	0.030	0.25	0.090	0.170	1000
MVU14-10FBK	01587	16-14	10	0.30	0.25	0.85	0.70	0.030	0.25	0.090	0.170	1000

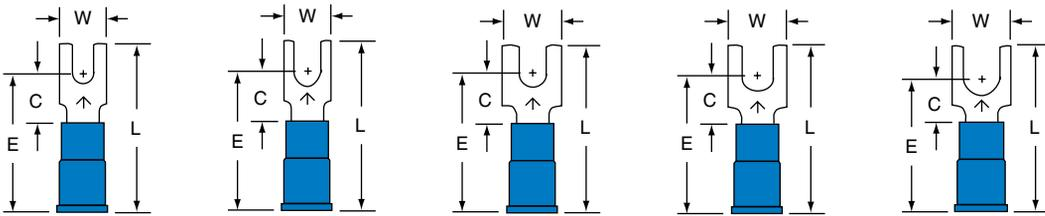

MVU14-4FB/S

MVU14-6FB/S

MVU14-6FB

MVU14-8FB

MVU14-10FB

Stud Size

4

6

6

8

10

Wire Range

16-14

16-14

16-14

16-14

16-14

¹Product number ending in X = box; product number ending with K = bulk.

3M™ Block Forks — Vinyl Insulated Butted Seam 12-10 AWG



Product Number*	UPC (054007-)	Wire Range (AWG)	Stud Size	W	C	L	E	Thickness	Barrel Length	Barrel I.D.	Maximum Insulation Diameter	Terminals per Case
MVU10-6FBK	02020	12-10	6	0.32	0.29	1.03	0.84	0.040	0.25	0.135	0.250	500
MVU10-8FBK	02021	12-10	8	0.32	0.29	1.03	0.84	0.040	0.25	0.135	0.250	500
MVU10-10FBK	02022	12-10	10	0.32	0.29	1.03	0.84	0.040	0.25	0.135	0.250	500

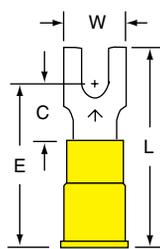

MVU10-6FB

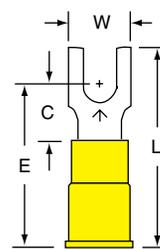

MVU10-8FB

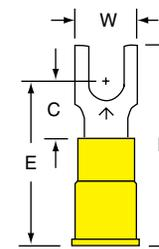

MVU10-10FB

Stud Size	6	8	10
Wire Range	12-10	12-10	12-10

3M™ Block Forks — Nylon Insulated with Insulation Grip 22-18 AWG



Product Number*	UPC (054007-)	Wire Range (AWG)	Stud Size	W	C	L	E	Thickness	Barrel Length	Barrel I.D.	Maximum Insulation Diameter	Terminals per Carton	Case
MNG18-4FB/SK	02261	22-18	4	0.25	0.25	0.84	0.69	0.030	0.25	0.070	0.145	—	1000
MNG18-6FB/SX	49603	22-18	6	0.25	0.25	0.84	0.69	0.030	0.25	0.070	0.145	100	500
MNG18-6FB/SK	01214	22-18	6	0.25	0.25	0.84	0.69	0.030	0.25	0.070	0.145	—	1000
MNG18-6FBX	22013	22-18	6	0.30	0.25	0.84	0.69	0.030	0.25	0.070	0.145	100	500
MNG18-6FBK	01215	22-18	6	0.30	0.25	0.84	0.69	0.030	0.25	0.070	0.145	—	1000
MNG18-8FBX	22021	22-18	8	0.30	0.25	0.84	0.69	0.030	0.25	0.070	0.145	100	500
MNG18-8FBK	01216	22-18	8	0.30	0.25	0.84	0.69	0.030	0.25	0.070	0.145	—	1000
MNG18-10FBX	22039	22-18	10	0.30	0.25	0.84	0.69	0.030	0.25	0.070	0.145	100	500
MNG18-10FBK	01217	22-18	10	0.30	0.25	0.84	0.69	0.030	0.25	0.070	0.145	—	1000

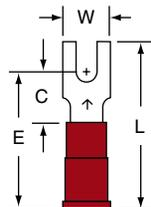

MNG18-4FB/S

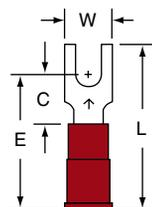

MNG18-6FB/S

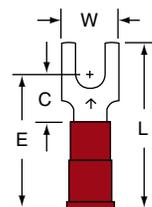

MNG18-6FB

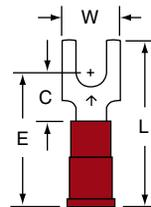

MNG18-8FB

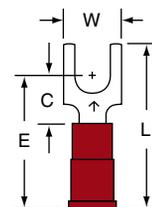

MNG18-10FB

Stud Size	4	6	6	8	10
Wire Range	22-18	22-18	22-18	22-18	22-18

*Product number ending in X = box; product number ending with K = bulk.

3M™ Block Forks — Nylon Insulated with Insulation Grip 16-14 AWG



Product Number ¹	UPC (054007-)	Wire Range (AWG)	Stud Size	W	C	L	E	Thickness	Barrel Length	Barrel I.D.	Maximum Insulation Diameter	Terminals per: Carton	Case
MNG14-4FB/SK	02262	16-14	4	0.25	0.25	0.86	0.71	0.030	0.25	0.090	0.170	—	1000
MNG14-6FB/SX	49625	16-14	6	0.25	0.25	0.86	0.71	0.030	0.25	0.090	0.170	100	500
MNG14-6FB/SK	01580	16-14	6	0.25	0.25	0.86	0.71	0.030	0.25	0.090	0.170	—	1000
MNG14-6FBX	22674	16-14	6	0.30	0.25	0.86	0.71	0.030	0.25	0.090	0.170	100	500
MNG14-6FBK	01581	16-14	6	0.30	0.25	0.86	0.71	0.030	0.25	0.090	0.170	—	1000
MNG14-8FBX	22682	16-14	8	0.30	0.25	0.86	0.71	0.030	0.25	0.090	0.170	100	500
MNG14-8FBK	01582	16-14	8	0.30	0.25	0.86	0.71	0.030	0.25	0.090	0.170	—	1000
MNG14-10FBX	22690	16-14	10	0.30	0.25	0.86	0.71	0.030	0.25	0.090	0.170	100	500
MNG14-10FBK	01583	16-14	10	0.30	0.25	0.86	0.71	0.030	0.25	0.090	0.170	—	1000

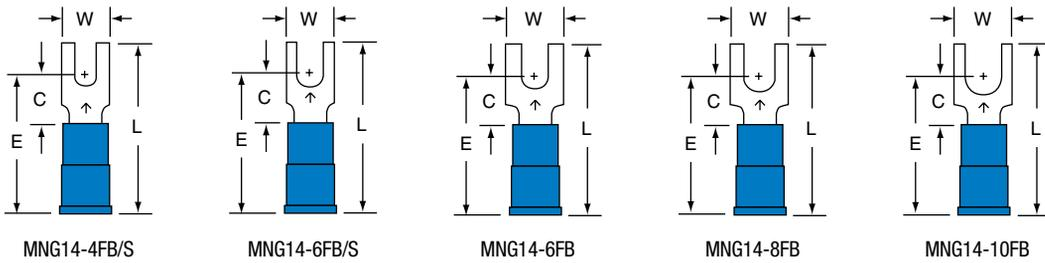

Stud Size	4	6	6	8	10
Wire Range	16-14	16-14	16-14	16-14	16-14

3M™ Block Forks — Nylon Insulated with Insulation Grip 12-10 AWG



Product Number ¹	UPC (054007-)	Wire Range (AWG)	Stud Size	W	C	L	E	Thickness	Barrel Length	Barrel I.D.	Maximum Insulation Diameter	Terminals per: Carton	Case
MNG10-6FBX	23722	12-10	6	0.32	0.29	1.03	0.84	0.040	0.25	0.135	0.250	50	500
MNG10-6FBK	02017	12-10	6	0.32	0.29	1.03	0.84	0.040	0.25	0.135	0.250	—	500
MNG10-8FBX	23730	12-10	8	0.32	0.29	1.03	0.84	0.040	0.25	0.135	0.250	50	500
MNG10-8FBK	02018	12-10	8	0.32	0.29	1.03	0.84	0.040	0.25	0.135	0.250	—	500
MNG10-10FBX	23748	12-10	10	0.32	0.29	1.03	0.84	0.040	0.25	0.135	0.250	50	500
MNG10-10FBK	02019	12-10	10	0.32	0.29	1.03	0.84	0.040	0.25	0.135	0.250	—	500

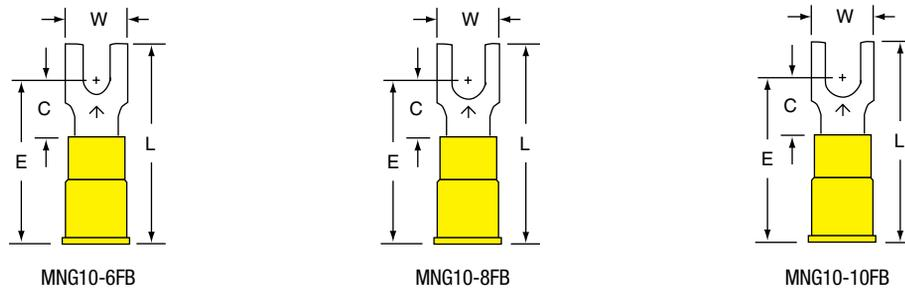

Stud Size	6	8	10
Wire Range	12-10	12-10	12-10

¹Product number ending in X = box; product number ending with K = bulk.

Flanged Block Forks

3M™ Flanged Block Forks — Non-Insulated Brazed Seam



Product Number*	UPC (054007-)	Wire Range (AWG)	Stud Size	W	C	L	E	Thickness	Barrel Length	Barrel I.D.	Terminals per Case
M14-6FFBK	01617	16-14	6	0.30	0.25	0.65	0.50	0.030	0.25	0.090	1000
M14-8FFBK	01618	16-14	8	0.30	0.25	0.65	0.50	0.030	0.25	0.090	1000
M14-10FFBK	01619	16-14	10	0.30	0.25	0.65	0.50	0.030	0.25	0.090	1000
M10-8FFBK	02027	12-10	8	0.32	0.29	0.73	0.54	0.040	0.25	0.135	500
M10-10FFBK	02028	12-10	10	0.32	0.29	0.73	0.54	0.040	0.25	0.135	500

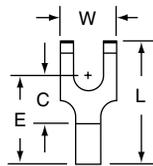

M18-6FFB

Stud Size

6

Wire Range

22-18

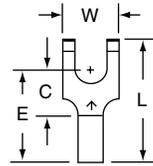

M18-8FFB

8

22-18

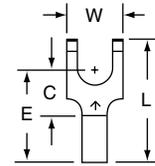

M18-10FFB

10

22-18

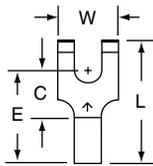

M14-6FFB

Stud Size

6

Wire Range

16-14

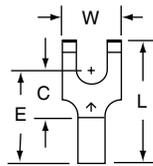

M14-8FFB

8

16-14

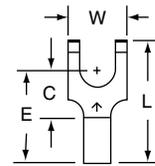

M14-10FFB

10

16-14

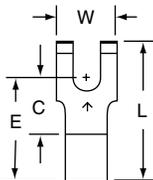

M10-6FFB

Stud Size

6

Wire Range

12-10

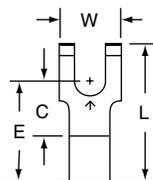

M10-8FFB

8

12-10

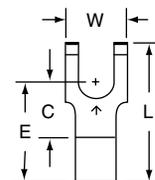

M10-10FFB

10

12-10

*Product number ending in X = box; product number ending with K = bulk.

3M™ Flanged Block Forks — Non-Insulated Butted Seam



Product Number ¹	UPC (054007-)	Wire Range (AWG)	Stud Size	W	C	L	E	Thickness	Barrel Length	Barrel I.D.	Terminals per Case
MU18-6FFBK	01247	22-18	6	0.30	0.25	0.65	0.50	0.030	0.25	0.070	1000
MU14-6FFBK	01613	16-14	6	0.30	0.25	0.65	0.50	0.030	0.25	0.090	1000
MU14-8FFBK	01614	16-14	8	0.30	0.25	0.65	0.50	0.030	0.25	0.090	1000
MU14-10FFBK	01615	16-14	10	0.30	0.25	0.65	0.50	0.030	0.25	0.090	1000
MU10-6FFBK	02023	12-10	6	0.32	0.29	0.73	0.54	0.040	0.25	0.135	500
MU10-8FFBK	02024	12-10	8	0.32	0.29	0.73	0.54	0.040	0.25	0.135	500
MU10-10FFBK	02025	12-10	10	0.32	0.29	0.73	0.54	0.040	0.25	0.135	500

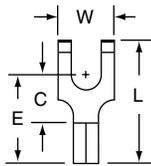

MU18-6FFB

Stud Size

6

Wire Range

22-18

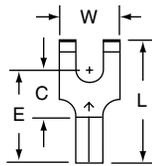

MU14-6FFB

6

16-14

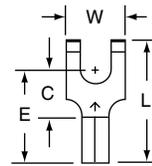

MU14-8FFB

8

16-14

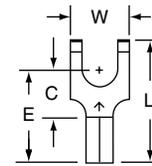

MU14-10FFB

10

16-14

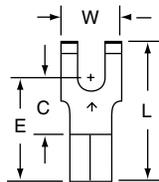

MU10-6FFB

Stud Size

6

Wire Range

12-10

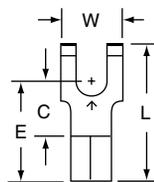

MU10-8FFB

8

12-10

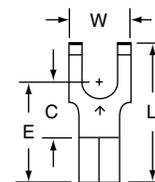

MU10-10FFB

10

12-10

¹Product number ending in X = box; product number ending with K = bulk.

3M™ Flanged Block Forks — Vinyl Insulated Brazed Seam



Product Number*	UPC (054007-)	Wire Range (AWG)	Stud Size	W	C	L	E	Thickness	Barrel Length	Barrel I.D.	Maximum Insulation Diameter	Terminals per Case
MV18-8FFBK	01260	22-18	8	0.30	0.25	0.85	0.70	0.030	0.25	0.070	0.145	1000
MV18-10FFBK	01261	22-18	10	0.30	0.25	0.85	0.70	0.030	0.25	0.070	0.145	1000
MV14-6FFBK	01625	16-14	6	0.30	0.25	0.85	0.70	0.030	0.25	0.090	0.170	1000
MV14-8FFBK	01626	16-14	8	0.30	0.25	0.85	0.70	0.030	0.25	0.090	0.170	1000
MV14-10FFBK	01627	16-14	10	0.30	0.25	0.85	0.70	0.030	0.25	0.090	0.170	1000
MV10-8FFBK	02033	12-10	8	0.32	0.29	1.03	0.84	0.040	0.25	0.135	0.250	500
MV10-10FFBK	02034	12-10	10	0.32	0.29	1.03	0.84	0.040	0.25	0.135	0.250	500

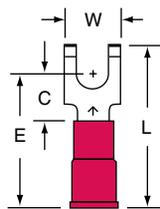

MV18-8FFBK

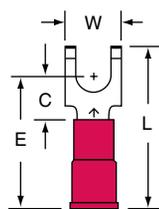

MV18-10FFBK

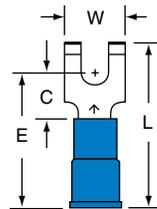

MV14-6FFBK

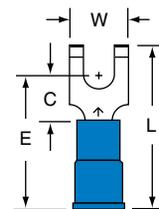

MV14-8FFBK

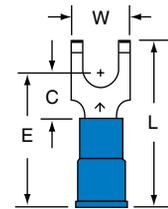

MV14-10FFBK

Stud Size
Wire Range

8
22-18

10
22-18

6
16-14

8
16-14

10
16-14

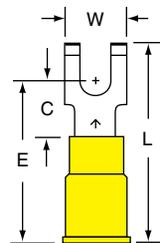

MV10-8FFBK

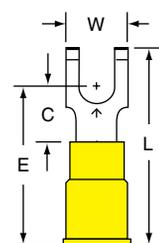

MV10-10FFBK

Stud Size
Wire Range

8
12-10

10
12-10

*Product number ending in X = box; product number ending with K = bulk.

3M™ Flanged Block Forks — Vinyl Insulated Butted Seam



Product Number*	UPC (054007-)	Wire Range (AWG)	Stud Size	W	C	L	E	Thickness	Barrel Length	Barrel I.D.	Maximum Insulation Diameter	Terminals per Case
MVU18-6FFBK	01267	22-18	6	0.30	0.25	0.85	0.70	0.030	0.25	0.070	0.145	1000
MVU18-8FFBK	01268	22-18	8	0.30	0.25	0.85	0.70	0.030	0.25	0.070	0.145	1000
MVU18-10FFBK	01269	22-18	10	0.30	0.25	0.85	0.70	0.030	0.25	0.070	0.145	1000
MVU14-6FFBK	01633	16-14	6	0.30	0.25	0.85	0.70	0.030	0.25	0.090	0.170	1000
MVU14-8FFBK	01634	16-14	8	0.30	0.25	0.85	0.70	0.030	0.25	0.090	0.170	1000
MVU14-10FFBK	01635	16-14	10	0.30	0.25	0.85	0.70	0.030	0.25	0.090	0.170	1000
MVU10-6FFBK	02038	12-10	6	0.32	0.29	1.03	0.84	0.040	0.25	0.135	0.250	500
MVU10-8FFBK	02039	12-10	8	0.32	0.29	1.03	0.84	0.040	0.25	0.135	0.250	500
MVU10-10FFBK	02040	12-10	10	0.32	0.29	1.03	0.84	0.040	0.25	0.135	0.250	500

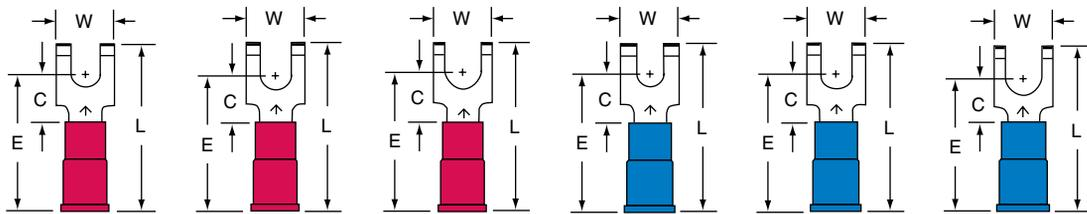

	MVU18-6FFBK	MVU18-8FFBK	MVU18-10FFBK	MVU14-6FFBK	MVU14-8FFBK	MVU14-10FFBK
Stud Size	6	8	10	6	8	10
Wire Range	22-18	22-18	22-18	16-14	16-14	16-14

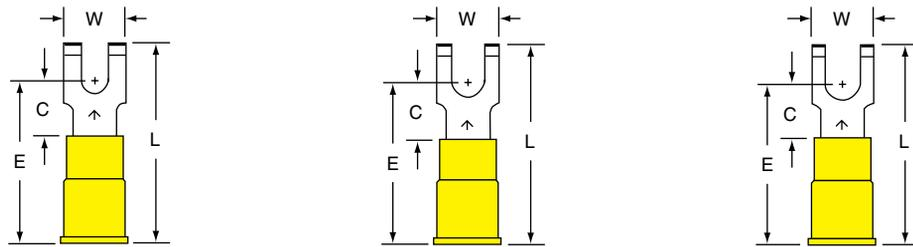

	MVU10-6FFBK	MVU10-8FFBK	MVU10-10FFBK
Stud Size	6	8	10
Wire Range	12-10	12-10	12-10

*Product number ending in X = box; product number ending with K = bulk.

3M™ Flanged Block Forks — Nylon Insulated with Insulation Grip



TERMINALS, KITS AND TOOLS • Flanged Block Forks

Product Number*	UPC (054007-)	Wire Range (AWG)	Stud Size	W	C	L	E	Thickness	Barrel Length	Barrel I.D.	Maximum Insulation Diameter	Terminals per Carton	Case
MNG18-6FFB/SX	49604	22-18	6	0.25	0.25	0.84	0.69	0.030	0.25	0.070	0.145	100	500
MNG18-6FFBK	01263	22-18	6	0.30	0.25	0.84	0.69	0.030	0.25	0.070	0.145	—	1000
MNG18-8FFBX	49605	22-18	8	0.30	0.25	0.84	0.69	0.030	0.25	0.070	0.145	100	500
MNG18-8FFBK	01264	22-18	8	0.30	0.25	0.84	0.69	0.030	0.25	0.070	0.145	—	1000
MNG18-10FFBX	49606	22-18	10	0.30	0.25	0.84	0.69	0.030	0.25	0.070	0.145	100	500
MNG18-10FFBK	01265	22-18	10	0.30	0.25	0.84	0.69	0.030	0.25	0.070	0.145	—	1000
MNG14-6FFB/SX	49626	16-14	6	0.25	0.25	0.86	0.71	0.030	0.25	0.090	0.170	100	500
MNG14-6FFBK	01629	16-14	6	0.30	0.25	0.86	0.71	0.030	0.25	0.090	0.170	—	1000
MNG14-8FFBX	49627	16-14	8	0.30	0.25	0.86	0.71	0.030	0.25	0.090	0.170	100	500
MNG14-8FFBK	01630	16-14	8	0.30	0.25	0.86	0.71	0.030	0.25	0.090	0.170	—	1000
MNG14-10FFBX	49628	16-14	10	0.30	0.25	0.86	0.71	0.030	0.25	0.090	0.170	100	500
MNG14-10FFBK	01631	16-14	10	0.30	0.25	0.86	0.71	0.030	0.25	0.090	0.170	—	1000
MNG10-6FFBX	49642	12-10	6	0.32	0.29	1.03	0.84	0.040	0.25	0.135	0.250	50	500
MNG10-6FFBK	02035	12-10	6	0.32	0.29	1.03	0.84	0.040	0.25	0.135	0.250	—	500
MNG10-8FFBX	49643	12-10	8	0.32	0.29	1.03	0.84	0.040	0.25	0.135	0.250	50	500
MNG10-8FFBK	02036	12-10	8	0.32	0.29	1.03	0.84	0.040	0.25	0.135	0.250	—	500
MNG10-10FFBX	49644	12-10	10	0.32	0.29	1.03	0.84	0.040	0.25	0.135	0.250	50	500
MNG10-10FFBK	02037	12-10	10	0.32	0.29	1.03	0.84	0.040	0.25	0.135	0.250	—	500

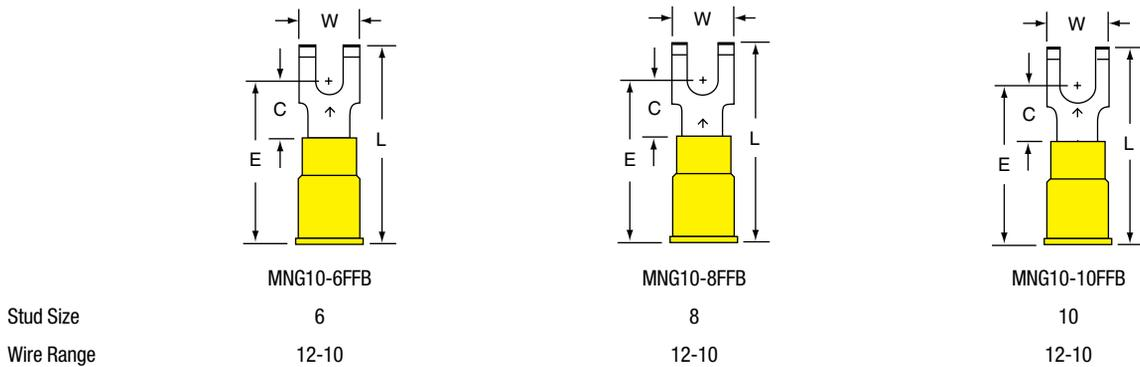
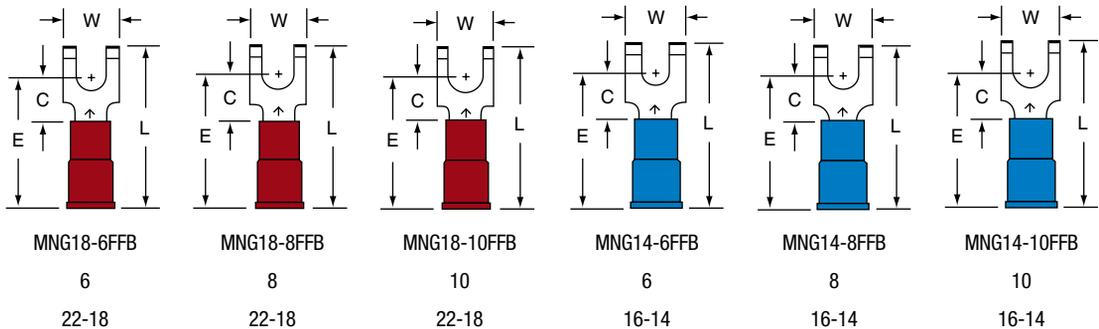

*Product number ending in X = box; product number ending with K = bulk.

Locking Forks

3M™ Locking Forks — Non-Insulated Brazed Seam 22-18 AWG



Product Number ¹	UPC (054007-)	Wire Range (AWG)	Stud Size	W	C	L	E	Thickness	Barrel Length	Barrel I.D.	Maximum Insulation Diameter	Terminals per: Carton	Case
M18-4FLK	13725	22-18	4	0.27	0.25	0.25	0.68	0.50	0.030	0.25	0.070	—	1000
M18-6FLX	13732	22-18	6	0.27	0.25	0.25	0.68	0.50	0.030	0.25	0.070	100	500
M18-6FLK	13733	22-18	6	0.27	0.25	0.25	0.68	0.50	0.030	0.25	0.070	—	1000
M18-8FLX	13750	22-18	8	0.34	0.30	0.25	0.68	0.50	0.030	0.25	0.070	100	500
M18-10FLX	13757	22-18	10	0.35	0.32	0.25	0.68	0.50	0.030	0.25	0.070	100	500
M18-10FLK	13758	22-18	10	0.35	0.32	0.25	0.68	0.50	0.030	0.25	0.070	—	1000

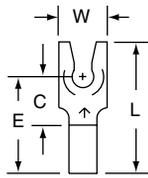

M18-4FL

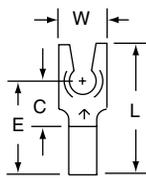

M18-6FL

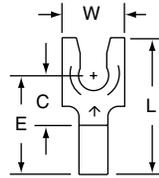

M18-8FL

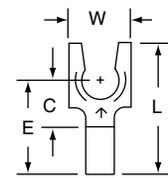

M18-10FL

Stud Size

4

6

8

10

Wire Range

22-18

22-18

22-18

22-18

3M™ Locking Forks — Non-Insulated Brazed Seam 16-14 ATG



Product Number ¹	UPC (054007-)	Wire Range (AWG)	Stud Size	W	C	L	E	Thickness	Barrel Length	Barrel I.D.	Terminals per: Carton	Case
M14-6FLX	13773	16-14	6	0.27	0.25	0.68	0.50	0.030	0.25	0.090	100	500
M14-6FLK	13775	16-14	6	0.27	0.25	0.68	0.50	0.030	0.25	0.090	—	1000
M14-8FLX	13781	16-14	8	0.34	0.30	0.68	0.50	0.030	0.25	0.090	100	500
M14-8FLK	13782	16-14	8	0.34	0.30	0.68	0.50	0.030	0.25	0.090	—	1000
M14-10FLX	13799	16-14	10	0.35	0.32	0.68	0.50	0.030	0.25	0.090	100	500
M14-10FLK	13800	16-14	10	0.35	0.32	0.68	0.50	0.030	0.25	0.090	—	1000
M14-14FLX	13807	16-14	1/4	0.48	0.43	0.90	0.65	0.030	0.25	0.090	100	500

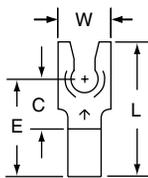

M14-6FL

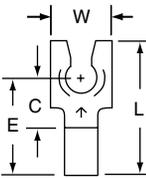

M14-8FL

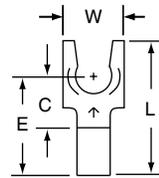

M14-10FL

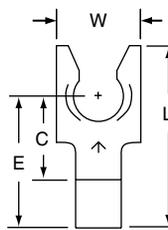

M14-14FL

Stud Size

6

8

10

1/4

Wire Range

16-14

16-14

16-14

16-14

¹Product number ending in X = box; product number ending with K = bulk.

3M™ Locking Forks — Non-Insulated Brazed Seam 12-10 AWG



Product Number ¹	UPC (054007-)	Wire Range (AWG)	Stud Size	Max. Lock Width	W	C	L	E	Thickness	Barrel Length	Barrel I.D.	Terminals per Carton	Case
M10-6FLX	13815	12-10	6	0.30	0.28	0.28	0.73	0.53	0.040	0.25	0.135	50	500
M10-6FLK	13817	12-10	6	0.30	0.28	0.28	0.73	0.53	0.040	0.25	0.135	—	500
M10-8FLX	13823	12-10	8	0.35	0.32	0.28	0.73	0.53	0.040	0.25	0.135	50	500
M10-8FLK	13824	12-10	8	0.35	0.32	0.28	0.73	0.53	0.040	0.25	0.135	—	500
M10-10FLX	13831	12-10	10	0.36	0.32	0.28	0.73	0.53	0.040	0.25	0.135	50	500
M10-10FLK	13832	12-10	10	0.36	0.32	0.28	0.73	0.53	0.040	0.25	0.135	—	500
M10-14FLX	13849	12-10	1/4	0.48	0.43	0.44	0.94	0.69	0.040	0.25	0.135	50	500
M10-14FLK	13850	12-10	1/4	0.48	0.43	0.44	0.94	0.69	0.040	0.25	0.135	—	500

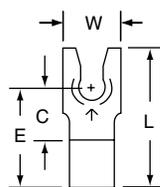

M10-6FL

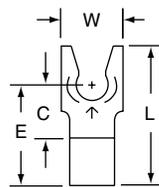

M10-8FL

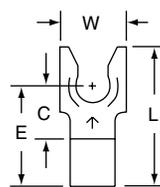

M10-10FL

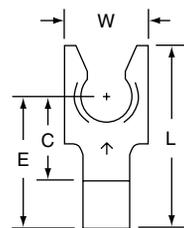

M10-14FL

Stud Size

6

8

10

1/4

Wire Range

12-10

12-10

12-10

12-10

3M™ Locking Forks — Non-Insulated Butted Seam 22-18 AWG



Product Number ¹	UPC (054007-)	Wire Range (AWG)	Stud Size	Max. Lock Width	W	C	L	E	Thickness	Barrel Length	Barrel I.D.	Terminals per Case
MU18-4FLK	01347	22-18	4	0.27	0.25	0.25	0.68	0.50	0.030	0.25	0.070	1000
MU18-6FLK	01348	22-18	6	0.27	0.25	0.25	0.68	0.50	0.030	0.25	0.070	1000
MU18-8FLK	01349	22-18	8	0.34	0.30	0.25	0.68	0.50	0.030	0.25	0.070	1000
MU18-10FLK	01350	22-18	10	0.35	0.32	0.25	0.68	0.50	0.030	0.25	0.070	1000

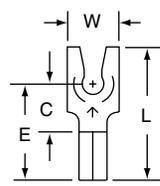

MU18-4FL

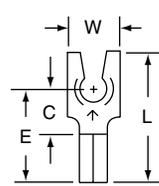

MU18-6FL

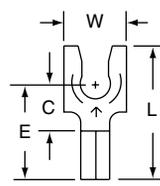

MU18-8FL

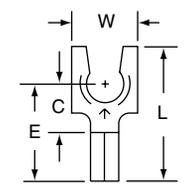

MU18-10FL

Stud Size

4

6

8

10

Wire Range

22-18

22-18

22-18

22-18

¹Product number ending in X = box; product number ending with K = bulk.

3M™ Locking Forks — Non-Insulated Butted Seam 16-14 AWG



Product Number*	UPC (054007-)	Wire Range (AWG)	Stud Size	Max. Lock Width	W	C	L	E	Thickness	Barrel Length	Barrel I.D.	Terminals per Case
MU14-4FLK	01856	16-14	4	0.27	0.25	0.25	0.68	0.50	0.030	0.25	0.090	1000
MU14-6FLK	01857	16-14	6	0.27	0.25	0.25	0.68	0.50	0.030	0.25	0.090	1000
MU14-8FLK	01858	16-14	8	0.34	0.30	0.25	0.68	0.50	0.030	0.25	0.090	1000
MU14-10FLK	01859	16-14	10	0.35	0.32	0.25	0.68	0.50	0.030	0.25	0.090	1000
MU14-14FLK	01860	16-14	1/4	0.48	0.43	0.40	0.90	0.65	0.030	0.25	0.090	1000

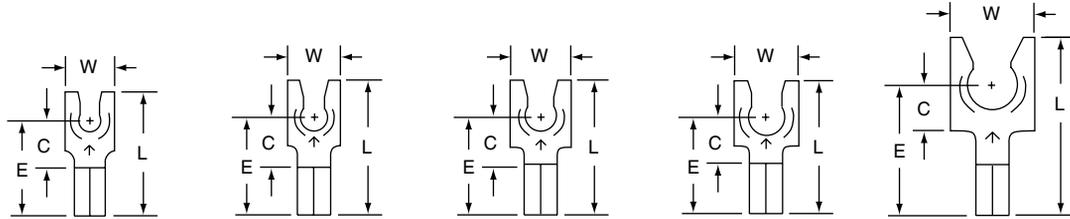

MU14-4FL

MU14-6FL

MU14-8FL

MU14-10FL

MU14-14FL

Stud Size

4

6

8

10

1/4

Wire Range

16-14

16-14

16-14

16-14

16-14

3M™ Locking Forks — Non-Insulated Butted Seam 12-10 AWG



Product Number*	UPC (054007-)	Wire Range (AWG)	Stud Size	Max. Lock Width	W	C	L	E	Thickness	Barrel Length	Barrel I.D.	Terminals per Case
MU10-6FLK	02102	12-10	6	0.30	0.28	0.28	0.73	0.53	0.040	0.25	0.135	500
MU10-8FLK	02103	12-10	8	0.35	0.32	0.28	0.73	0.53	0.040	0.25	0.135	500
MU10-10FLK	02104	12-10	10	0.36	0.32	0.28	0.73	0.53	0.040	0.25	0.135	500
MU10-14FLK	02105	12-10	1/4	0.48	0.43	0.44	0.94	0.69	0.040	0.25	0.135	500

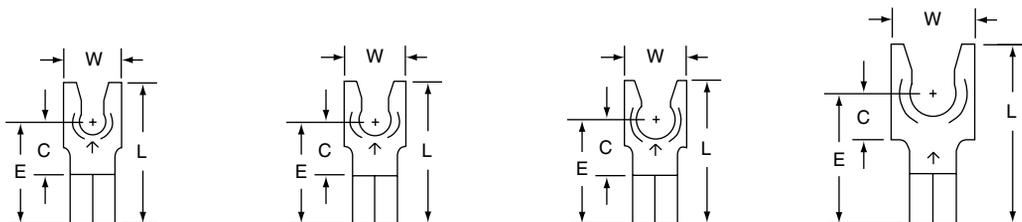

MU10-6FL

MU10-8FL

MU10-10FL

MU10-14FL

Stud Size

6

8

10

1/4

Wire Range

12-10

12-10

12-10

12-10

*Product number ending in X = box; product number ending with K = bulk.

3M™ Locking Forks — Non-Insulated Brazed Seam 22-18 AWG



Product Number	UPC (054007-)	Wire Range (AWG)	Stud Size	Max Lock Width	W	C	L	E	Thickness	Barrel Length	Barrel I.D.	Maximum Insulation Diameter	Terminals per: Carton	Case
MV18-4FLX	13856	22-18	4	0.27	0.25	0.25	0.88	0.70	0.030	0.25	0.070	0.145	100	500
MV18-4FLK	13857	22-18	4	0.27	0.25	0.25	0.88	0.70	0.030	0.25	0.070	0.145	—	1000
MV18-6FLX	13864	22-18	6	0.27	0.25	0.25	0.88	0.70	0.030	0.25	0.070	0.145	100	500
MV18-6FLK	13865	22-18	6	0.27	0.25	0.25	0.88	0.70	0.030	0.25	0.070	0.145	—	1000
MV18-8FLX	13872	22-18	8	0.34	0.30	0.25	0.88	0.70	0.030	0.25	0.070	0.145	100	500
MV18-8FLK	13873	22-18	8	0.34	0.30	0.25	0.88	0.70	0.030	0.25	0.070	0.145	—	1000
MV18-10FLX	13890	22-18	10	0.35	0.32	0.25	0.88	0.70	0.030	0.25	0.070	0.145	100	500
MV18-10FLK	13891	22-18	10	0.35	0.32	0.25	0.88	0.70	0.030	0.25	0.070	0.145	—	1000

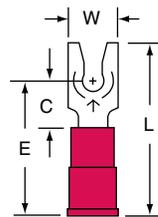

MV18-4FL

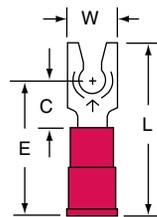

MV18-6FL

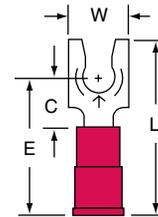

MV18-8FL

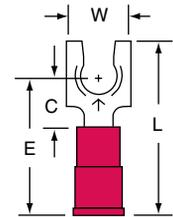

MV18-10FL

Stud Size

4

6

8

10

Wire Range

22-18

22-18

22-18

22-18

3M™ Locking Forks — Non-Insulated Brazed Seam 16-14 AWG



Product Number	UPC (054007-)	Wire Range (AWG)	Stud Size	Max Lock Width	W	C	L	E	Thickness	Barrel Length	Barrel I.D.	Maximum Insulation Diameter	Terminals per: Carton	Case
MV14-4FLX	13898	16-14	4	0.27	0.25	0.25	0.88	0.70	0.030	0.25	0.090	0.170	100	500
MV14-6FLX	13906	16-14	6	0.27	0.25	0.25	0.88	0.70	0.030	0.25	0.090	0.170	100	500
MV14-6FLK	13907	16-14	6	0.27	0.25	0.25	0.88	0.70	0.030	0.25	0.090	0.170	—	1000
MV14-8FLX	13914	16-14	8	0.34	0.30	0.25	0.88	0.70	0.030	0.25	0.090	0.170	100	500
MV14-8FLK	13915	16-14	8	0.34	0.30	0.25	0.88	0.70	0.030	0.25	0.090	0.170	—	1000
MV14-10FLX	13922	16-14	10	0.35	0.32	0.25	0.88	0.70	0.030	0.25	0.090	0.170	100	500
MV14-10FLK	13923	16-14	10	0.35	0.32	0.25	0.88	0.70	0.030	0.25	0.090	0.170	—	1000
MV14-14FLX	13940	16-14	1/4	0.48	0.43	0.40	1.10	0.85	0.030	0.25	0.090	0.170	100	500
MV14-14FLK	13941	16-14	1/4	0.48	0.43	0.40	1.10	0.85	0.030	0.25	0.090	0.170	—	1000

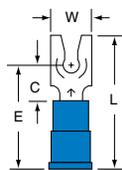

MV14-4FL

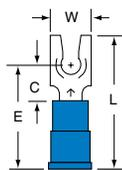

MV14-6FL

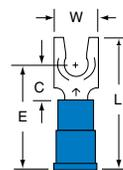

MV14-8FL

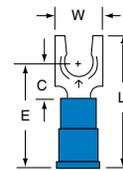

MV14-10FL

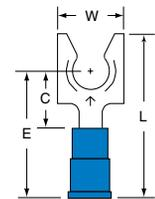

MV14-14FL

Stud Size

4

6

8

10

1/4

Wire Range

16-14

16-14

16-14

16-14

16-14

*Product number ending in X = box; product number ending with K = bulk.

3M™ Locking Forks — Vinyl Insulated Brazed Seam 12-10 AWG



Product Number ¹	UPC (054007-)	Wire Range (AWG)	Stud Size	Max Lock Width	W	C	L	E	Thickness	Barrel Length	Barrel I.D.	Maximum Insulation Diameter	Terminals per: Carton	Case
MV10-6FLX	13948	12-10	6	0.30	0.28	0.28	1.03	0.83	0.040	0.25	0.135	0.250	50	500
MV10-6FLK	13949	12-10	6	0.30	0.28	0.28	1.03	0.83	0.040	0.25	0.135	0.250	—	500
MV10-8FLX	13955	12-10	8	0.35	0.32	0.28	1.03	0.83	0.040	0.25	0.135	0.250	50	500
MV10-8FLK	13956	12-10	8	0.35	0.32	0.28	1.03	0.83	0.040	0.25	0.135	0.250	—	500
MV10-10FLX	13963	12-10	10	0.36	0.32	0.28	1.03	0.83	0.040	0.25	0.135	0.250	50	500
MV10-10FLK	13964	12-10	10	0.36	0.32	0.28	1.03	0.83	0.040	0.25	0.135	0.250	—	500
MV10-14FLX	13971	12-10	1/4	0.48	0.43	0.44	1.24	0.99	0.040	0.25	0.135	0.250	50	500
MV10-14FLK	13972	12-10	1/4	0.48	0.43	0.44	1.24	0.99	0.040	0.25	0.135	0.250	—	500

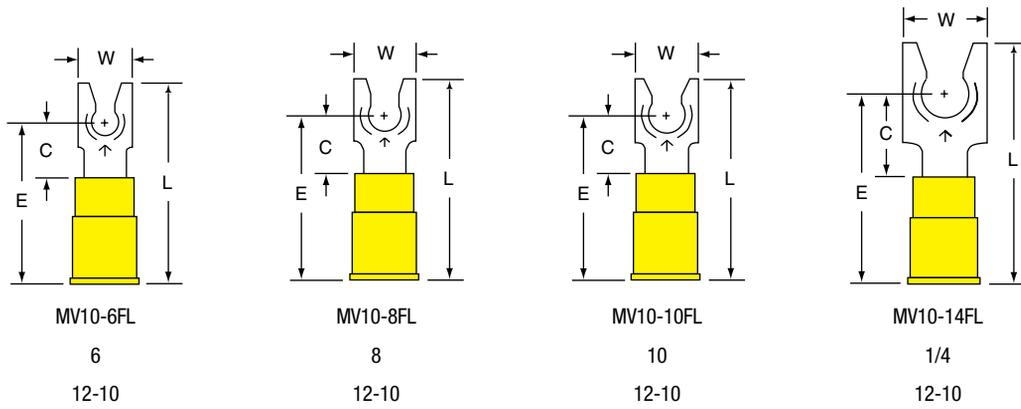

3M™ Locking Forks — Vinyl Insulated Butted Seam 22-18 AWG



Product Number ¹	UPC (054007-)	Wire Range (AWG)	Stud Size	Max Lock Width	W	C	L	E	Thickness	Barrel Length	Barrel I.D.	Maximum Insulation Diameter	Terminals per: Case
MVU18-4FLK	01359	22-18	4	0.27	0.25	0.25	0.88	0.70	0.030	0.25	0.070	0.145	1000
MVU18-6FLK	01360	22-18	6	0.27	0.25	0.25	0.88	0.70	0.030	0.25	0.070	0.145	1000
MVU18-8FLK	01361	22-18	8	0.34	0.30	0.25	0.88	0.70	0.030	0.25	0.070	0.145	1000
MVU18-10FLK	01362	22-18	10	0.35	0.32	0.25	0.88	0.70	0.030	0.25	0.070	0.145	1000

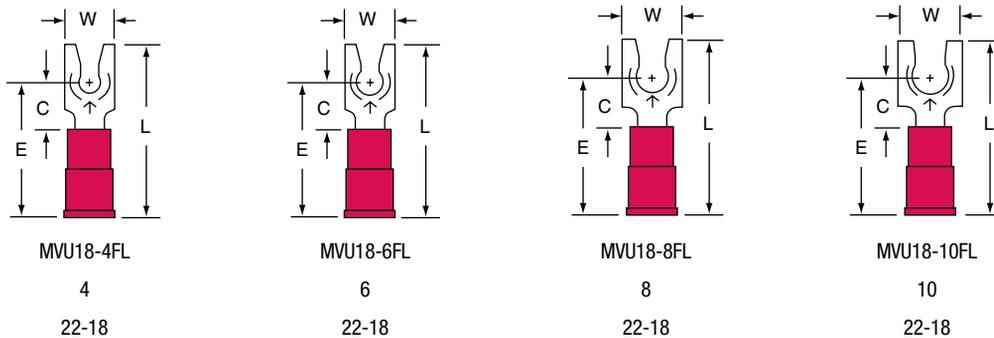

¹Product number ending in X = box; product number ending with K = bulk.

3M™ Locking Forks — Vinyl Insulated Butted Seam 16-14 AWG



Product Number*	UPC (054007-)	Wire Range (AWG)	Stud Size	Max Lock Width	W	C	L	E	Thickness	Barrel Length	Barrel I.D.	Maximum Insulation Diameter	Terminals per Case
MVU14-4FLK	01871	16-14	4	0.27	0.25	0.25	0.88	0.70	0.030	0.25	0.090	0.170	1000
MVU14-6FLK	01872	16-14	6	0.27	0.25	0.25	0.88	0.70	0.030	0.25	0.090	0.170	1000
MVU14-8FLK	01873	16-14	8	0.34	0.30	0.25	0.88	0.70	0.030	0.25	0.090	0.170	1000
MVU14-10FLK	01874	16-14	10	0.35	0.32	0.25	0.88	0.70	0.030	0.25	0.090	0.170	1000
MVU14-14FLK	01875	16-14	1/4	0.48	0.43	0.40	1.10	0.85	0.030	0.25	0.090	0.170	1000

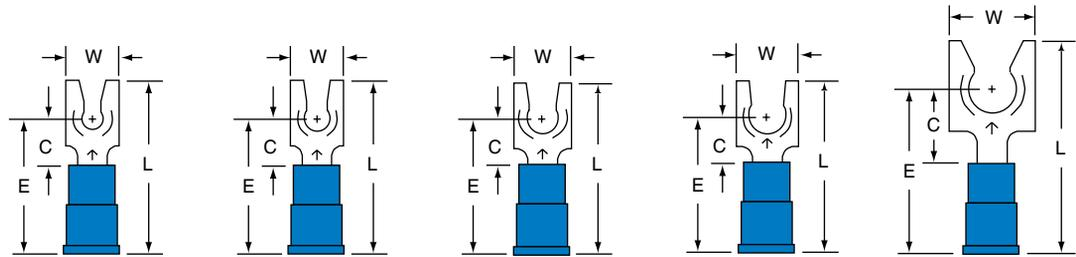

Stud Size	4	6	8	10	1/4
Wire Range	16-14	16-14	16-14	16-14	16-14

3M™ Locking Forks — Vinyl Insulated Butted Seam 12-10 AWG



Product Number*	UPC (054007-)	Wire Range (AWG)	Stud Size	Max Lock Width	W	C	L	E	Thickness	Barrel Length	Barrel I.D.	Maximum Insulation Diameter	Terminals per Case
MVU10-6FLK	02114	12-10	6	0.30	0.28	0.28	1.03	0.83	0.040	0.25	0.135	0.250	500
MVU10-8FLK	02115	12-10	8	0.35	0.32	0.28	1.03	0.83	0.040	0.25	0.135	0.250	500
MVU10-10FLK	02116	12-10	10	0.36	0.32	0.28	1.03	0.83	0.040	0.25	0.135	0.250	500
MVU10-14FLK	02117	12-10	1/4	0.48	0.43	0.44	1.24	0.99	0.040	0.25	0.135	0.250	500

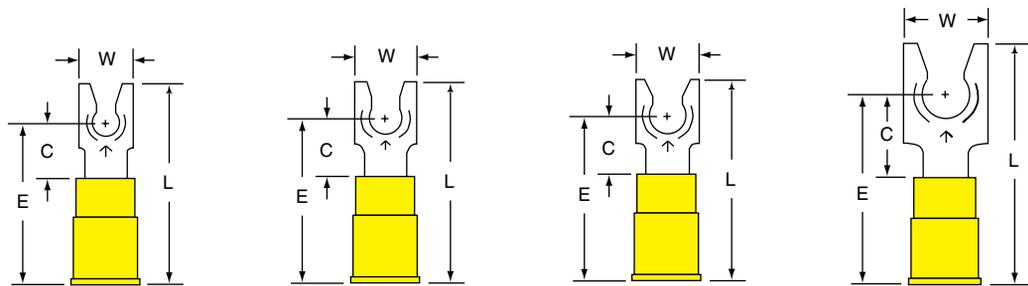

Stud Size	6	8	10	1/4
Wire Range	12-10	12-10	12-10	12-10

*Product number ending in X = box; product number ending with K = bulk.

3M™ Locking Forks — Nylon Insulated with Insulation Grip 22-18 AWG



Product Number*	UPC (054007-)	Wire Range (AWG)	Stud Size	Max Lock Width	W	C	L	E	Thickness	Barrel Length	Barrel I.D.	Maximum Insulation Diameter	Terminals per Carton	Case
MNG18-4FLX	11706	22-18	4	0.27	0.25	0.25	0.87	0.69	0.030	0.25	0.070	0.145	100	500
MNG18-4FLK	01355	22-18	4	0.27	0.25	0.25	0.87	0.69	0.030	0.25	0.070	0.145	—	1000
MNG18-6FLX	11707	22-18	6	0.27	0.25	0.25	0.87	0.69	0.030	0.25	0.070	0.145	100	500
MNG18-6FLK	01356	22-18	6	0.27	0.25	0.25	0.87	0.69	0.030	0.25	0.070	0.145	—	1000
MNG18-8FLX	11708	22-18	8	0.34	0.30	0.25	0.87	0.69	0.030	0.25	0.070	0.145	100	500
MNG18-8FLK	01357	22-18	8	0.34	0.30	0.25	0.87	0.69	0.030	0.25	0.070	0.145	—	1000
MNG18-10FLX	11709	22-18	10	0.35	0.32	0.25	0.87	0.69	0.030	0.25	0.070	0.145	100	500
MNG18-10FLK	01358	22-18	10	0.35	0.32	0.25	0.87	0.69	0.030	0.25	0.070	0.145	—	1000

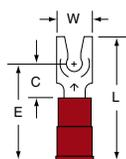

MNG18-4FL

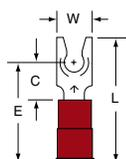

MNG18-6FL

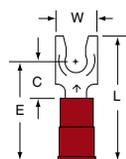

MNG18-8FL

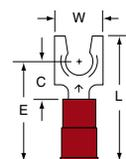

MNG18-10FL

Stud Size

4

6

8

10

Wire Range

22-18

22-18

22-18

22-18

3M™ Locking Forks — Nylon Insulated with Insulation Grip 16-14 AWG



Product Number*	UPC (054007-)	Wire Range (AWG)	Stud Size	Max Lock Width	W	C	L	E	Thickness	Barrel Length	Barrel I.D.	Maximum Insulation Diameter	Terminals per Carton	Case
MNG14-4FLX	11717	16-14	4	0.27	0.25	0.25	0.89	0.71	0.030	0.25	0.090	0.170	100	500
MNG14-4FLK	01866	16-14	4	0.27	0.25	0.25	0.89	0.71	0.030	0.25	0.090	0.170	—	1000
MNG14-6FLX	11718	16-14	6	0.27	0.24	0.25	0.89	0.71	0.030	0.25	0.090	0.170	100	500
MNG14-6FLK	01867	16-14	6	0.27	0.24	0.25	0.89	0.71	0.030	0.25	0.090	0.170	—	1000
MNG14-8FLX	11719	16-14	8	0.34	0.30	0.25	0.89	0.71	0.030	0.25	0.090	0.170	100	500
MNG14-8FLK	01868	16-14	8	0.34	0.30	0.25	0.89	0.71	0.030	0.25	0.090	0.170	—	1000
MNG14-10FLX	11720	16-14	10	0.35	0.32	0.25	0.89	0.71	0.030	0.25	0.090	0.170	100	500
MNG14-10FLK	01869	16-14	10	0.35	0.32	0.25	0.89	0.71	0.030	0.25	0.090	0.170	—	1000
MNG14-14FLX	11721	16-14	1/4	0.48	0.43	0.40	1.11	0.86	0.030	0.25	0.090	0.170	100	500
MNG14-14FLK	01870	16-14	1/4	0.48	0.43	0.40	1.11	0.86	0.030	0.25	0.090	0.170	—	1000

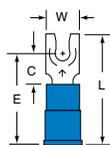

MNG14-4FL

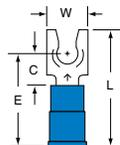

MNG14-6FL

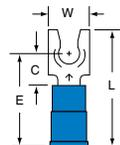

MNG14-8FL

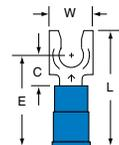

MNG14-10FL

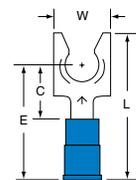

MNG14-14FL

Stud Size

4

6

8

10

1/4

Wire Range

16-14

16-14

16-14

16-14

16-14

*Product number ending in X = box; product number ending with K = bulk.



3M™ Locking Forks — Nylon Insulated with Insulation Grip 12-10 AWG



Product Number ¹	UPC (054007-)	Wire Range (AWG)	Stud Size	Max Lock Width	W	C	L	E	Thickness	Barrel Length	Barrel I.D.	Maximum Insulation Diameter	Terminals per: Carton	Case
MNG10-6FLX	11725	12-10	6	0.30	0.28	0.28	1.03	0.83	0.040	0.25	0.135	0.250	50	500
MNG10-6FLK	02106	12-10	6	0.30	0.28	0.28	1.03	0.83	0.040	0.25	0.135	0.250	—	500
MNG10-8FLX	11726	12-10	8	0.35	0.32	0.28	1.03	0.83	0.040	0.25	0.135	0.250	50	500
MNG10-8FLK	02107	12-10	8	0.35	0.32	0.28	1.03	0.83	0.040	0.25	0.135	0.250	—	500
MNG10-10FLX	11727	12-10	10	0.36	0.32	0.28	1.03	0.83	0.040	0.25	0.135	0.250	50	500
MNG10-10FLK	02108	12-10	10	0.36	0.32	0.28	1.03	0.83	0.040	0.25	0.135	0.250	—	500
MNG10-14FLX	11728	12-10	1/4	0.48	0.43	0.44	1.24	0.99	0.040	0.25	0.135	0.250	50	500
MNG10-14FLK	02109	12-10	1/4	0.48	0.43	0.44	1.24	0.99	0.040	0.25	0.135	0.250	—	500

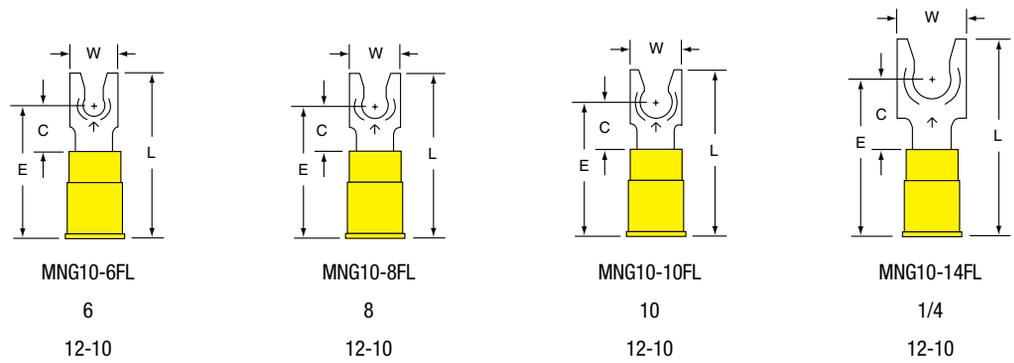

3M™ Locking Forks — Heat Shrink Brazed Seam 22-18 AWG



Product Number ¹	UPC (054007-)	Wire Range (AWG)	Stud Size	W	C	L	E	Thickness	Barrel Length	Barrel I.D.	Terminals per: Carton	Case
MH18-6FLX	06346	22-18	6	0.25	0.15	1.00	0.76	0.030	0.25	0.070	25	100
MH18-6FLK	06347	22-18	6	0.25	0.15	1.00	0.76	0.030	0.25	0.070	—	250
MH18-8FLX	06363	22-18	8	0.30	0.15	1.00	0.70	0.030	0.25	0.090	25	100
MH18-8FLK	06362	22-18	8	0.30	0.15	1.00	0.70	0.030	0.25	0.090	—	250
MH18-10FLX	06352	22-18	10	0.32	0.15	1.00	0.76	0.030	0.25	0.070	25	100
MH18-10FLK	06353	22-18	10	0.32	0.15	1.00	0.76	0.030	0.25	0.070	—	250

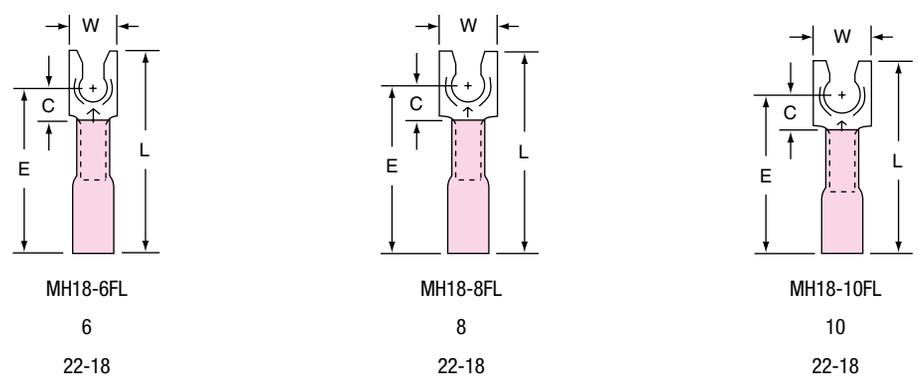

¹Product number ending in X = box; product number ending with K = bulk.

3M™ Locking Forks — Heat Shrink Brazed Seam 16-14 AWG



Product Number ¹	UPC (054007-)	Wire Range (AWG)	Stud Size	W	C	L	E	Thickness	Barrel Length	Barrel I.D.	Terminals per: Bag	Case
MH14-6FLX	06322	16-14	6	0.25	0.12	1.00	0.76	0.030	0.25	0.090	25	100
MH14-6FLK	06323	16-14	6	0.25	0.12	1.00	0.76	0.030	0.25	0.090	—	250
MH14-8FLX	06361	16-14	8	0.30	0.12	1.00	0.70	0.030	0.25	0.090	25	100
MH14-8FLK	06360	16-14	8	0.30	0.12	1.00	0.70	0.030	0.25	0.090	—	250
MH14-10FLX	06328	16-14	10	0.32	0.12	1.00	0.76	0.030	0.25	0.090	25	100
MH14-10FLK	06329	16-14	10	0.32	0.12	1.00	0.76	0.030	0.25	0.090	—	250
MH14-14FLX	06332	16-14	1/4	0.43	0.27	1.1	0.85	0.030	0.25	0.090	25	100
MH14-14FLK	06333	16-14	1/4	0.43	0.27	1.1	0.85	0.030	0.25	0.090	—	250

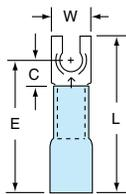

MH14-6FL

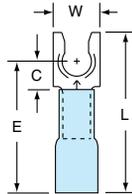

MH14-8FL

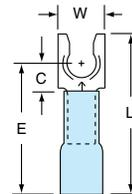

MH14-10FL

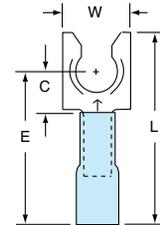

MH14-14FL

Stud Size

6

8

10

1/4

Wire Range

16-14

16-14

16-14

16-14

3M™ Locking Forks — Heat Shrink Brazed Seam 12-10 AWG



Product Number ¹	UPC (054007-)	Wire Range (AWG)	Stud Size	W	C	L	E	Thickness	Barrel Length	Barrel I.D.	Terminals per: Bag	Case
MH10-8FLX	06304	12-10	8	0.32	0.16	1.00	0.80	0.040	0.25	0.135	25	100
MH10-8FLK	06358	12-10	8	0.32	0.16	1.00	0.80	0.040	0.25	0.135	—	250
MH10-10FLX	06307	12-10	10	0.32	0.16	1.00	0.80	0.040	0.25	0.135	25	100
MH10-10FLK	06308	12-10	10	0.32	0.16	1.00	0.80	0.040	0.25	0.135	—	250
MH10-14FLX	06310	12-10	1/4	0.43	0.30	1.2	0.95	0.040	0.25	0.135	25	100
MH10-14FLK	06311	12-10	1/4	0.43	0.30	1.2	0.95	0.040	0.25	0.135	—	250

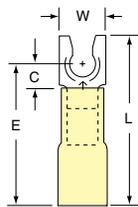

MH10-8FL

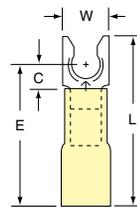

MH10-10FL

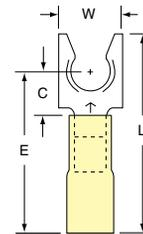

MH10-14FL

Stud Size

8

10

1/4

Wire Range

12-10

12-10

12-10

¹Product number ending in X = box; product number ending with K = bulk.

Butt Connectors

3M™ Butt Connectors — Non-Insulated Seamless



Product Number*	UPC (054007-)	Wire Range (AWG)	L	Thickness	Barrel Length	Barrel I.D.	Terminals per: Carton	Case
M18BCX	22187	22-18	0.63	0.031	0.28	0.062	100	500
M18BCK	01311	22-18	0.63	0.031	0.28	0.062	—	1000
M14BCX	23102	16-14	0.66	0.031	0.30	0.095	100	500
M14BCK	01816	16-14	0.66	0.031	0.30	0.095	—	1000
M10BCX	24019	12-10	0.81	0.038	0.38	0.142	50	500
M10BCK	02077	12-10	0.81	0.038	0.38	0.142	—	500

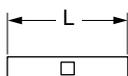

M18BC

Wire Range
22-18

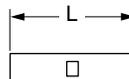

M14BC

Wire Range
16-14

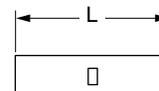

M10BC

Wire Range
12-10

3M™ Butt Connectors — Non-Insulated Brazed Seam



Product Number*	UPC (054007-)	Wire Range (AWG)	L	Thickness	Barrel Length	Barrel I.D.	Terminals per: Carton	Case
M8BCX	24167	8	0.81	0.050	0.38	0.175	25	250
M8BCK	02143	8	0.81	0.050	0.38	0.175	—	200
M6BCX	24225	6	1.02	0.050	0.47	0.250	20	200
M6BCK	02172	6	1.02	0.050	0.47	0.250	—	200
M4BCX	24282	4	1.13	0.075	0.53	0.280	15	150
M4BCK	02197	4	1.13	0.075	0.53	0.280	—	200

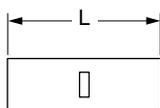

M8BC

Wire Range
8

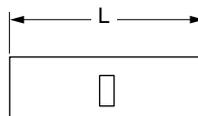

M6BC

Wire Range
6

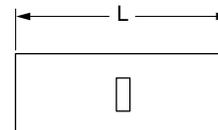

M4BC

Wire Range
4

*Product number ending in X = box; product number ending with K = bulk.

3M™ Large Gauge Butt Connectors — Non-Insulated Copper Seamless

Product Number*	UPC (054007-)	Color Code	Wire Range	L	Barrel I.D.	Inner Unit Pack.	Case Qty.
MC2BCX	09205	Brown	2 AWG	1.38" (34,3 mm)	0.34" (8,6 mm)	10/box	100
MC1BCX	09206	Green	1 AWG	1.38" (34,3 mm)	0.36" (9,3 mm)	10/box	100
MC1/0BCX	09207	Pink	1/0 AWG	1.55" (39,4 mm)	0.41" (10,5 mm)	10/box	100
MC2/0BCX	09208	Black	2/0 AWG	1.80" (45,7 mm)	0.46" (11,8 mm)	10/box	100
MC3/0BCX	09209	Orange	3/0 AWG	1.90" (48,3 mm)	0.51" (13,1 mm)	3/box	30
MC4/0BCX	09210	Purple	4/0 AWG	2.00" (50,8 mm)	0.56" (14,3 mm)	3/box	30
MC250BCX	09211	Yellow	250 kcmil	2.25" (50,8 mm)	0.630" (15,1 mm)	3/box	30

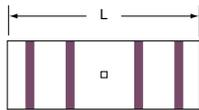

MC2BCX

Wire Range

2

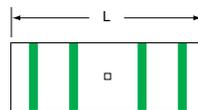

MC1BCX

1

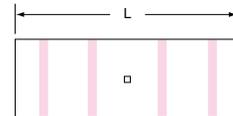

MC1/0BCX

1/0

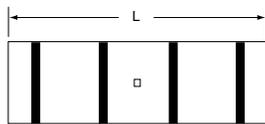

MC2/0BCX

Wire Range

2/0

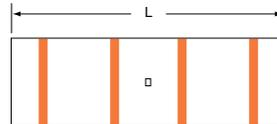

MC3/0BCX

3/0

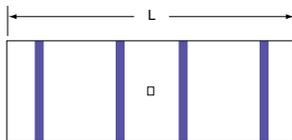

MC4/0BCX

Wire Range

4/0

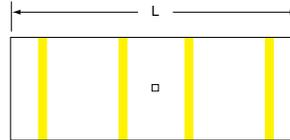

MC250BCX

250 kcmil

3M™ Butt Connectors — Vinyl Insulated Seamless



Product Number*	UPC (054007-)	Wire Range	L	Thickness	Barrel Length	Barrel I.D.	Max Insulation Diameter	Inner Unit Pack.	Case Qty.
MV18BCX	22195	22-18 AWG	0.310" (7,874 mm)	0.030" (0,762 mm)	0.250" (6,35 mm)	0.070" (1,778 mm)	0.145" (3,683 mm)	100/ carton	500
MV18BCK	01312	22-18 AWG	0.310" (7,874 mm)	0.030" (0,762 mm)	0.250" (6,35 mm)	0.070" (1,778 mm)	0.145" (3,683 mm)		500
MV14BCX	23110	16-14 AWG	0.310" (7,874 mm)	0.030" (0,762 mm)	0.250" (6,35 mm)	0.090" (2,286 mm)	0.170" (4,138 mm)	100/ carton	500
MV14BCK	01817	16-14 AWG	0.310" (7,874 mm)	0.030" (0,762 mm)	0.250" (6,35 mm)	0.090" (2,286 mm)	0.170" (4,138 mm)		500
MV10BCX	24027	12-10 AWG	0.310" (7,874 mm)	0.040" (1,016 mm)	0.250" (6,35 mm)	0.135" (3,429 mm)	0.250" (6,35 mm)	50/ carton	500
MV10BCK	02078	12-10 AWG	0.310" (7,874 mm)	0.040" (1,016 mm)	0.250" (6,35 mm)	0.135" (3,429 mm)	0.250" (6,35 mm)		500

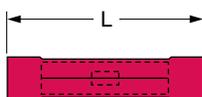

MV18BCX

Wire Range

22-18

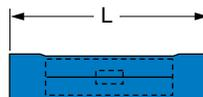

MV14BCX

16-14

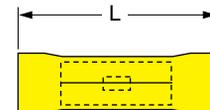

MV10BCX

12-10

*Product number ending in X = box; product number ending with K = bulk.

3M™ Butt Connectors — Vinyl Insulated Brazed Seam



Product Number	UPC (054007-)	Wire Range (AWG)	L	Thickness	Barrel Length	Barrel I.D.	Max Insulation Diameter	Terminals per Carton	Case
MV8BCX	15678	8	1.40	0.050	0.38	0.175	0.385	25	250
MV8BCK	02144	8	1.40	0.050	0.38	0.175	0.385	—	200
MV6BCX	49647	6	1.69	0.050	0.47	0.250	0.440	20	200
MV6BCK	02173	6	1.69	0.050	0.47	0.250	0.440	—	200
MV4BCK	02198	4	2.12	0.075	0.53	0.280	0.515	—	200

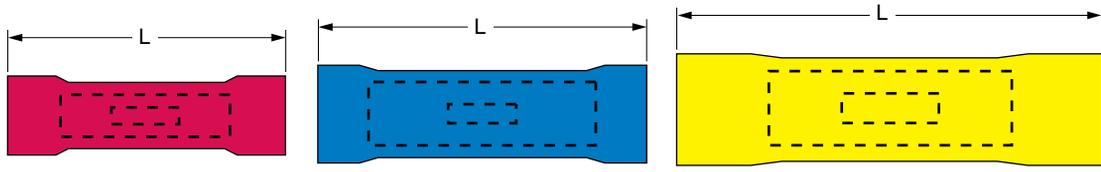

Wire Range 8 6 4

3M™ Butt Connectors — Vinyl Insulated Butted Seam



Product Number	UPC (054007-)	Wire Range (AWG)	L	Thickness	Barrel Length	Barrel I.D.	Max Insulation Diameter	Terminals per Carton	Case
MVU18BCK	01315	22-18	1.00	0.030	0.25	0.070	0.145	—	1000
MVU14BCK	01820	16-14	1.00	0.030	0.25	0.090	0.170	—	1000
MVU10BCK	02081	12-10	1.02	0.040	0.25	0.135	0.250	—	500

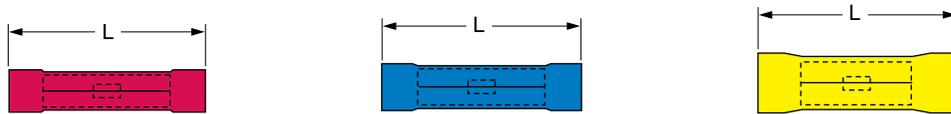

Wire Range 22-18 16-14 12-10

3M™ Butt Connectors — Nylon Insulated Seamless



Product Number	UPC (054007-)	Wire Range (AWG)	L	Thickness	Barrel Length	Barrel I.D.	Max Insulation Diameter	Terminals per Carton	Case
MN24BCX-A	98202	26-24	0.79	0.025	0.20	0.050	0.080	100	500
MN24BCK-A	98203*	26-24	0.79	0.025	0.20	0.050	0.080	—	1000
MN18BCX-A	22211	22-18	1.02	0.031	0.28	0.062	0.125	100	500
MN14BCX-A	23136	16-14	1.02	0.031	0.30	0.095	0.155	100	500
MN14BCK-A	01819	16-14	1.02	0.031	0.30	0.095	0.155	—	1000
MN10BCX-A	24043	12-10	1.20	0.038	0.38	0.142	0.218	50	500

* UPC prefix 051138

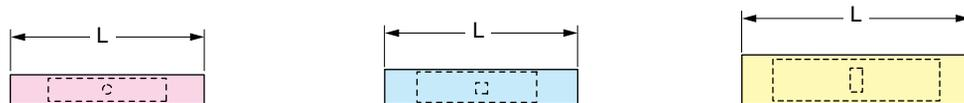

Wire Range 22-18 16-14 12-10

*Product number ending in X = box; product number ending with K = bulk.

3M™ Butt Connectors — Nylon Insulated with Insulation Grip



Product Number ¹	UPC (054007-)	Wire Range (AWG)	L	Thickness	Barrel Length	Barrel I.D.	Max Insulation Diameter	Terminals per: Carton	Case
MNG18BCX	22203	22-18	1.00	0.030	0.25	0.070	0.145	100	500
MNG18BCK	01313	22-18	1.00	0.030	0.25	0.070	0.145	—	1000
MNG14BCX	23128	16-14	1.00	0.030	0.25	0.090	0.170	100	500
MNG14BCK	01818	16-14	1.00	0.030	0.25	0.090	0.170	—	1000
MNG10BCX	24035	12-10	1.15	0.040	0.25	0.135	0.250	50	500
MNG10BCK	15967	12-10	1.15	0.040	0.25	0.135	0.250	—	500

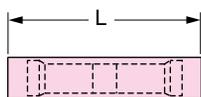

MNG18BC

Wire Range

22-18



MNG14BC

16-14

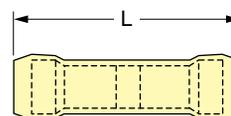

MNG10BC

12-10

3M™ Butt Connectors — Nylon Insulated with Insulation Grip Moisture Resistant[®] UL

Product Number ¹	UPC (051138-)	Wire Range (AWG)	L	Terminals per: Carton	Case
MNG18BCMX-A	98027	22-18	1.02	25	250
MNG18BCMK-A	98029	22-18	1.02	—	1000
MNG14BCMX-A	98032	16-14	1.02	25	250
MNG14BCMK-A	98035	16-14	1.06	—	1000
MNG10BCMX-A	98037	12-10	1.23	25	250
MNG10BCMK-A	98039	12-10	1.23	—	500

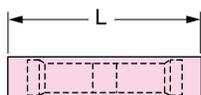

MNG18BCM-A

Wire Range

22-18

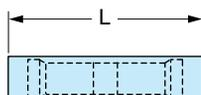

MNG14BCM-A

16-14

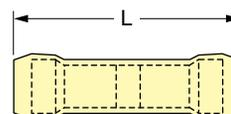

MNG10BCM-A

12-10

3M™ Butt Connectors — Heat Shrink Seamless



Product Number ¹	UPC (054007-)	Wire Range (AWG)	L	Thickness	Barrel Length	Barrel I.D.	Terminals per: Bag	Case
MH18BCX	06342	22-18	1.2	0.031	0.28	0.062	25	100
MH18BCK	06343	22-18	1.2	0.031	0.28	0.062	—	250
MH14BCX	06318	16-14	1.3	0.031	0.30	0.095	25	100
MH14BCK	06319	16-14	1.3	0.031	0.30	0.095	—	250
MH10BCX	06300	12-10	1.5	0.031	0.38	0.142	25	100
MH10BCK	06301	12-10	1.5	0.031	0.38	0.142	—	250

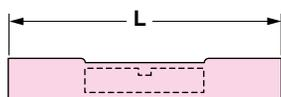

MH18BC

Wire Range

22-18

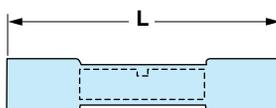

MH14BC

16-14

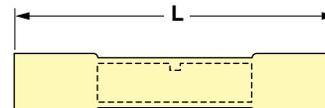

MH10BC

12-10

¹Product number ending in X = box; product number ending with K = bulk.

3M™ Step-Down Butt Connectors — Non-Insulated

Part Number	Min. Order Qty.	UPC 051128-	Side #1		Side #2	
			Color Stripe	Wire Gauge	Color Stripe	Wire Gauge
SD-610-S	1000	57020	White	22-24 AWG	Red	18-20 AWG
SD-621-S	1000	57021	Red	18-20 AWG	Blue	14-16 AWG
SD-632-S	1000	57022	Blue	14-16 AWG	Yellow	10-12 AWG
SD-643-S	1000	57023	Yellow	10-12 AWG	Red	8 AWG

3M™ Step-Down Butt Connectors — Vinyl

Part Number	Min. Order Qty.	UPC 051128-	Side #1		Side #2	
			Color Stripe	Wire Gauge	Color Stripe	Wire Gauge
SD-610-SP	1000	57024	White	22-24 AWG	Red	18-20 AWG
SD-621-SP	1000	57025	Red	18-20 AWG	Blue	14-16 AWG
SD-632-SP	1000	57026	Blue	14-16 AWG	Yellow	10-12 AWG
SD-643-SP	1000	57027	Yellow	10-12 AWG	Red	8 AWG

3M™ Step-Down Butt Connectors — Heat Shrink

Part Number	Min. Order Qty.	UPC 051128-	Heat Shrink Tubing Color	Side #1		Side #2	
				Color Stripe	Wire Gauge	Color Stripe	Wire Gauge
SD-610-SHS	1000	57028	Red	White	22-24 AWG	Red	18-20 AWG
SD-621-SHS	1000	57029	Blue	Red	18-20 AWG	Blue	14-16 AWG
SD-632-SHS	1000	57030	Yellow	Blue	14-16 AWG	Yellow	10-12 AWG
SD-643-SHS	1000	57031	Pink	Yellow	10-12 AWG	Red	8 AWG

*Product number ending in X = box; product number ending with K = bulk.

3M™ Multiple Wire Heat Shrink Butt Connectors

Part Number	Min. Order Qty.	UPC 051128-	Wire Gauge	Tubing Color	Color Stripe on Connector	Wire
MW-60-SHS	250	57032	24-22 AWG	Clear/White Dashes	Side 1: White / Side 2: Red	One 22-24 AWG / Two 22-24 AWG
MW-61-SHS	250	57033	20-18 AWG	Clear/Red Dashes	Side 1: Red / Side 2: Blue	One 18-20 AWG / Two 18-20 AWG
MW-62-SHS	250	57034	16-14 AWG	Clear/Blue Dashes	Side 1: Blue / Side 2: Yellow	One 14-16 AWG / Two 14-16 AWG
MW-63-SHS	250	57035	12-10 AWG	Clear/Yellow Dashes	Side 1: Yellow / Side 2: Red	One 10-12 AWG / Two 10-12 AWG

3M™ Step-Down Butt Connectors — Non-Insulated

Part Number	Min. Order Qty.	UPC 051128-	Connector Wire Gauge	Tubing Color
722-NHS	250	57208	22-14 AWG	Clear/Blue Dashes
718-NHS	250	57207	18-10 AWG	Clear/Yellow Dashes

*Product number ending in X = box; product number ending with K = bulk.

Female Disconnects

3M™ Female Disconnects — Non-Insulated Butted Seam



Product Number ¹	UPC (054007-)	Wire Range (AWG)**	Mates with Male Tab Width (W') x Thickness	L	Barrel Length	Barrel I.D.	Terminals per: Carton Case
MU20-110DFK-A*	00984	26-20	0.110 x 0.020	0.48	—	—	— 1000
MU20-110/32DFK-A*	00985	26-20	0.110 x 0.032	0.48	—	—	— 1000
MU18-187DFK	02366	22-18	0.187 x 0.020	0.58	0.25	0.085	— 1000
MU18-250DFX	16725	22-18	0.250 x 0.032	0.66	0.25	0.080	100 500
MU18-250DFK	01300	22-18	0.250 x 0.032	0.66	0.25	0.080	— 1000
MU14-110DFX-A*	57448***	16-14	0.110 x 0.020	0.54	0.19	0.115	100 500
MU14-110DFK*	13995	16-14	0.110 x 0.020	0.54	0.19	0.115	— 1000
MU14-187DFX	22831	16-14	0.187 x 0.020	0.58	0.25	0.085	100 500
MU14-187DFK	01767	16-14	0.187 x 0.020	0.58	0.25	0.085	— 1000
MU14-250DFX	22849	16-14	0.250 x 0.032	0.66	0.25	0.080	100 500
MU14-250DFK	01768	16-14	0.250 x 0.032	0.66	0.25	0.080	— 1000

* Not UL Listed or CSA Certified
 ** For #10-12 AWG, see MI10-250DF
 *** UPC prefix 051128

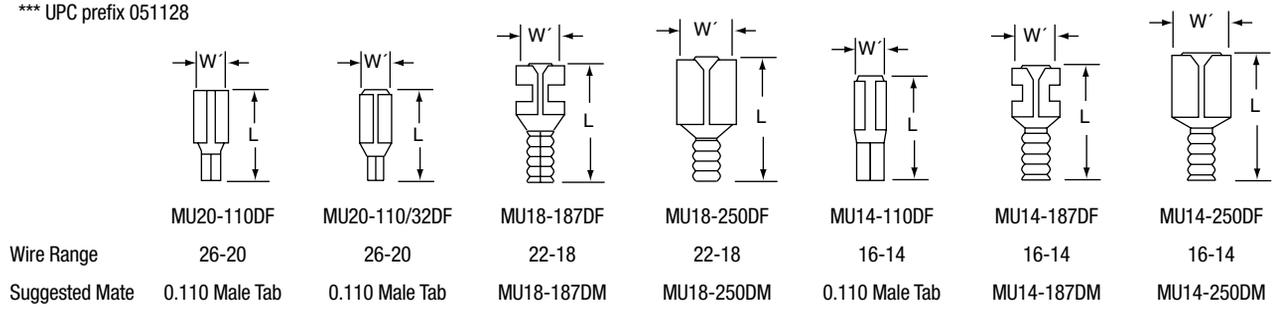

3M™ Female Disconnects — Non-Insulated Interlock Barrel



Product Number ¹	UPC (054007-)	Wire Range (AWG)**	Mates with Male Tab Width (W') x Thickness	L	Barrel Length	Barrel I.D.	Terminals per: Carton Case
MI18-250DFX	09979	22-18	0.250 x 0.032	0.63	0.25	0.076	100 500
MI18-250DFK	69561	22-18	0.250 x 0.032	0.63	0.25	0.076	— 1000
MI14-250DFX	09977	16-14	0.250 x 0.032	0.63	0.25	0.076	100 500
MI14-250DFK	69559	16-14	0.250 x 0.032	0.63	0.25	0.076	— 1000
MI10-250DFX	09975	12-10	0.250 x 0.032	0.64	0.25	0.128	50 500
MI10-250DFK	69557	12-10	0.250 x 0.032	0.64	0.25	0.128	— 500

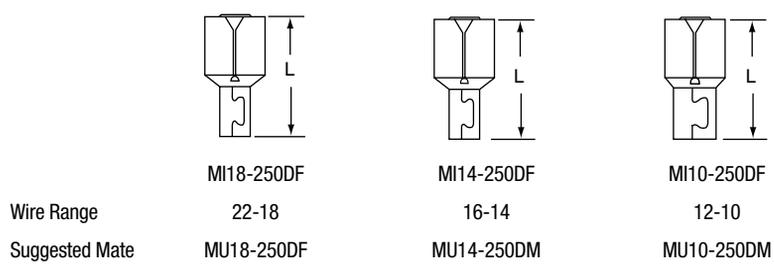

¹Product number ending in X = box; product number ending with K = bulk.

3M™ Female Disconnects — Non-Insulated Butted Seam Flag



Product Number [†]	UPC (054007-)	Wire Range (AWG)	Mates with Male Tab Width (W') x Thickness	L	Barrel Length	Barrel I.D.	Terminals per: Carton	Case
MU18-187DF/FLAG*	22138	22-18	0.187 x 0.020	0.46	0.20	0.075	100	500
MU18-187DF/FLAG*	01302	22-18	0.187 x 0.020	0.46	0.20	0.075	—	1000
MU18-250DF/FLAGX	22146	22-18	0.250 x 0.032	0.50	0.25	0.075	100	500
MU18-250DF/FLAGK	01303	22-18	0.250 x 0.032	0.50	0.25	0.075	—	1000
MU14-187DF/FLAG*	22948	16-14	0.187 x 0.020	0.47	0.20	0.095	100	500
MU14-187DF/FLAG*	01778	16-14	0.187 x 0.020	0.47	0.20	0.095	—	1000
MU14-250DF/FLAGX	22955	16-14	0.250 x 0.032	0.51	0.26	0.095	100	500
MU14-250DF/FLAGK	01779	16-14	0.250 x 0.032	0.51	0.26	0.095	—	1000

* Not UL Listed or CSA Certified

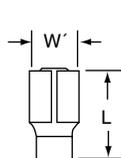

MU18-187DF/FLAG

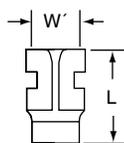

MU18-250DF/FLAG

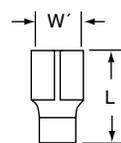

MU14-187DF/FLAG

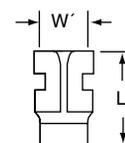

MU14-250DF/FLAG

Wire Range

22-18

22-18

16-14

16-14

Suggested Mate

0.187 Male Tab

0.250 Male Tab

0.187 Male Tab

0.250 Male Tab

3M™ Female Disconnects — Vinyl Insulated Butted Seam



Product Number [†]	UPC (054007-)	Wire Range (AWG)**	Mates with Male Tab Width (W') x Thickness	L	Barrel Length	Barrel I.D.	Maximum Insulation Diameter	Terminals per: Carton	Case
MVU18-187DFK	02368	22-18	0.187 x 0.020	0.78	0.25	0.085	0.145	—	1000
MVU18-250DFX	11820	22-18	0.250 x 0.032	0.87	0.25	0.080	0.145	100	500
MVU18-250DFK	01301	22-18	0.250 x 0.032	0.87	0.25	0.080	0.145	—	1000
MVU14-110DFK-A*	57438***	16-14	0.110 x 0.020	0.73	—	—	0.18	—	1000
MVU14-187DFX	22872	16-14	0.187 x 0.020	0.78	0.25	0.085	0.145	100	500
MVU14-187DFK	01776	16-14	0.187 x 0.020	0.78	0.25	0.085	0.145	—	1000
MVU14-250DFX	22880	16-14	0.250 x 0.032	0.87	0.25	0.080	0.145	100	500
MVU14-250DFK	01777	16-14	0.250 x 0.032	0.87	0.25	0.080	0.145	—	1000

* Not UL Listed or CSA Certified

** For #10-12 AWG, MVU10-250DF has been substituted with MVU10-250DF.

*** UPC prefix 051128

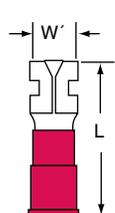

MVU18-187DF

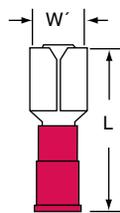

MVU18-250DF

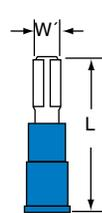

MVU14-110DF-A

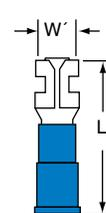

MVU14-187DF

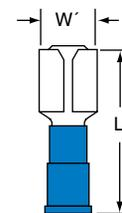

MVU14-250DF

Wire Range

22-18

22-18

16-14

16-14

16-14

Suggested Mate

MVU18-187DM

MVU18-250DM

0.110 Male Tab

MVU14-187DM

MVU14-250DM

† Product number ending in X = box; product number ending with K = bulk.



3M™ Female Disconnects — Vinyl Insulated Interlock Barrel



Product Number [†]	UPC (054007-)	Wire Range (AWG)	Mates with Male Tab Width (W') x Thickness	L	Barrel Length	Barrel I.D.	Maximum Insulation Diameter	Terminals per: Carton	Case
MVI18-187DFX	09996	22-18	0.187 x 0.020	0.77	0.25	0.080	0.145	100	500
MVI18-187DFK	69581	22-18	0.187 x 0.020	0.77	0.25	0.080	0.145	—	1000
MVI18-250DFX	09997	22-18	0.250 x 0.032	0.83	0.25	0.076	0.145	100	500
MVI18-250DFK	69582	22-18	0.250 x 0.032	0.83	0.25	0.076	0.145	—	1000
MVI14-187DFX	09999	16-14	0.187 x 0.020	0.77	0.25	0.080	0.145	100	500
MVI14-187DFK	69579	16-14	0.187 x 0.020	0.77	0.25	0.080	0.145	—	1000
MVI14-250DFX	69556	16-14	0.250 x 0.032	0.83	0.25	0.076	0.145	100	500
MVI14-250DFK	69580	16-14	0.250 x 0.032	0.83	0.25	0.076	0.145	—	1000
MVI10-250DFX	09998	12-10	0.250 x 0.032	0.95	0.25	0.128	0.250	50	500
MVI10-250DFK	69578	12-10	0.250 x 0.032	0.95	0.25	0.128	0.250	—	500

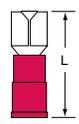

MVI18-187DF

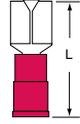

MVI18-250DF

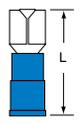

MVI14-187DF

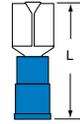

MVI14-250DF

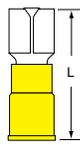

MVI10-250DF

Wire Range 22-18
Suggested Mate MVU18-187DM

Wire Range 22-18
Suggested Mate MVU18-250DM

Wire Range 16-14
Suggested Mate MVU14-187DM

Wire Range 16-14
Suggested Mate MVU14-250DM

Wire Range 12-10
Suggested Mate MVU10-250DM

3M™ Female Disconnects — Nylon Insulated with Insulation Grip



Product Number [†]	UPC (054007-)	Wire Range (AWG)**	Mates with Male Tab Width (W') x Thickness	L	Barrel Length	Barrel I.D.	Maximum Insulation Diameter	Terminals per: Carton	Case
MNG18-110DFX-A	57444**	22-18	0.187 x 0.020	0.77	0.25	0.085	0.145	—	1000
MNG18-110DFK-A	57445**	22-18	0.250 x 0.032	0.86	0.25	0.080	0.145	100	500
MNG18-187DFK	02405	22-18	0.110 x 0.020	0.77	—	—	0.16	—	—
MNG18-250DFX	02393	22-18	0.110 x 0.020	0.77	—	—	0.16	—	—
MNG18-250DFK	02369	22-18	0.250 x 0.032	0.86	0.25	0.080	0.145	—	1000
MNG14-110DFX-A*	57427**	16-14	0.110 x 0.020	0.77	—	—	0.20	100	500
MNG14-110DFK-A*	57437**	16-14	0.110 x 0.020	0.77	—	—	0.20	—	1000
MNG14-187DFX	22914	16-14	0.187 x 0.020	0.77	0.25	0.085	0.145	100	500
MNG14-187DFK	01773	16-14	0.187 x 0.020	0.77	0.25	0.085	0.145	—	1000
MNG14-250DFX	22930	16-14	0.250 x 0.032	0.86	0.25	0.080	0.145	100	500
MNG14-250DFK	01774	16-14	0.250 x 0.032	0.86	0.25	0.080	0.145	—	1000
MNG10-375DFK*	02053	12-10	0.375 x 0.050	1.23	0.25	0.175	0.250	—	500

* Not UL Listed or CSA Certified
** UPC prefix 051128

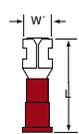

MNG18-187DF

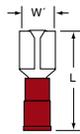

MNG18-250DF

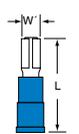

MNG14-110DF-A

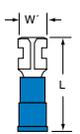

MNG14-187DF

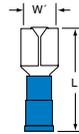

MNG14-250DF

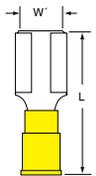

MNG10-375DF

Wire Range 22-18
Suggested Mate MNG18-187DM

Wire Range 22-18
Suggested Mate MNG18-250DM

Wire Range 16-14
Suggested Mate 0.110 Male Tab

Wire Range 16-14
Suggested Mate MNG14-187DM

Wire Range 16-14
Suggested Mate MNG14-250DM

Wire Range 12-10
Suggested Mate 0.375 Male Tab

[†]Product number ending in X = box; product number ending with K = bulk.

3M™ Female Disconnects — Vinyl Insulated with Insulation Grip

Product Number ¹	UPC (054007-)	Wire Range (AWG)	Mates with Male Tab Width (W') x Thickness	L	Barrel Length	Barrel I.D.	Maximum Insulation Diameter	Terminals per: Carton	Case
MVG24-110DFK*	95151	26-20	0.110 x 0.020	0.63	0.13	0.055	0.093	—	1000
MVG24-110/32DFX*	95176	26-20	0.110 x 0.032	0.63	0.13	0.055	0.093	100	500

* Not UL Listed or CSA Certified

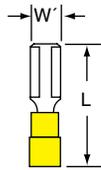

MVG24-110DF

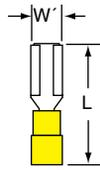

MVG24-110/32DF

Wire Range

26-20

26-20

Suggested Mate

0.110 Male Tab

0.110 Male Tab

3M™ Female Disconnects — Nylon Insulated with Insulation Grip Interlock Barrel



Product Number ¹	UPC (054007-)	Wire Range (AWG)	Mates with Male Tab Width (W') x Thickness	L	Barrel Length	Barrel I.D.	Maximum Insulation Diameter	Terminals per: Carton	Case
MNGI18-250DFX	09990	22-18	0.250 x 0.032	0.83	0.25	0.076	0.145	100	500
MNGI18-250DFK	69572	22-18	0.250 x 0.032	0.83	0.25	0.076	0.145	—	1000
MNGI14-187DFX	09987	16-14	0.187 x 0.020	0.77	0.25	0.080	0.145	100	500
MNGI14-187DFK	69569	16-14	0.187 x 0.020	0.77	0.25	0.080	0.145	—	1000
MNGI14-250DFX	09988	16-14	0.250 x 0.032	0.83	0.25	0.076	0.145	100	500
MNGI14-250DFK	69570	16-14	0.250 x 0.032	0.83	0.25	0.076	0.145	—	1000
MNGI10-250DFX	09986	12-10	0.250 x 0.032	0.94	0.25	0.128	0.250	50	500
MNGI10-250DFK	69568	12-10	0.250 x 0.032	0.94	0.25	0.128	0.250	—	500

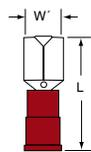

MNGI18-250DF

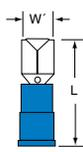

MNGI14-187DF

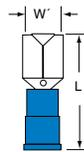

MNGI14-250DF

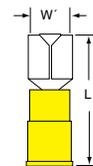

MNGI10-250DF

Wire Range

22-18

16-14

16-14

12-10

Suggested Mate

MNG18-250DM

MNG14-187DM

MNG14-250DM

MNG10-250DM

¹Product number ending in X = box; product number ending with K = bulk.

3M™ Female Disconnects — Nylon Insulated with Insulation Grip Bullet Style

Product Number ¹	UPC (051138-)	Wire Range (AWG)	Mating Snap Diameter		Maximum Insulation Diameter	Terminals per: Case	
			S	L		Carton	Case
MNG18-156DFIK-A	98078	22-18	0.156	0.99	0.15	—	1000
MNG18-180DFIK-A	98084	22-18	0.180	1.00	0.15	—	1000
MNG14-156DFIX-A	98118	16-14	0.156	0.99	0.19	100	500
MNG14-156DFIK-A	98117	16-14	0.156	0.99	0.19	—	1000
MNG14-180DFIX-A	98128	16-14	0.180	1.00	0.19	100	500
MNG14-180DFIK-A	98127	16-14	0.180	1.00	0.19	—	1000

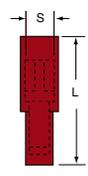

MNG18-156DFI-A

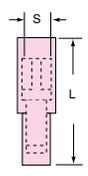

MNG18-180DFI-A

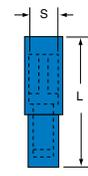

MNG14-156DFI-A

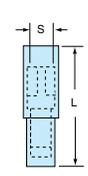

MNG14-180DFI-A

Wire Range
Suggested Mate

22-18
MNG18-156DM

22-18
MNG18-180DM

16-14
MNG14-156DM

16-14
MNG14-180DM

3M™ Female Disconnects — Nylon Fully Insulated Butted Seam



Product Number ¹	UPC (054007-)	Wire Range (AWG)**	Mates with Male Tab Width (W') x Thickness	L	W	D	Barrel Length	Barrel I.D.	Maximum Insulation Diameter	Terminals per: Case	
										Carton	Case
MNU18-187DFIX	02353	22-18	0.187 x 0.020	0.81	0.30	0.23	0.25	0.085	0.145	100	500
MNU18-187DFIK	02370	22-18	0.187 x 0.020	0.81	0.30	0.23	0.25	0.085	0.145	—	1000
MNU18-250DFIX	02286	22-18	0.250 x 0.032	0.87	0.37	0.23	0.25	0.080	0.145	100	500
MNU18-250DFIK	02290	22-18	0.250 x 0.032	0.87	0.37	0.23	0.25	0.080	0.145	—	1000
MNU14-187DFIX	02387	16-14	0.187 x 0.020	0.81	0.30	0.23	0.25	0.085	0.145	100	500
MNU14-187DFIK	02384	16-14	0.187 x 0.020	0.81	0.30	0.23	0.25	0.085	0.145	—	1000
MNU14-250DFIX	02287	16-14	0.250 x 0.032	0.87	0.37	0.23	0.25	0.080	0.145	50	500
MNU14-250DFIK	02291	16-14	0.250 x 0.032	0.87	0.37	0.23	0.25	0.080	0.145	—	1000

Not UL Listed or CSA Certified

**For #10-12 AWG, see MNI10-250DFI

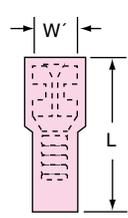
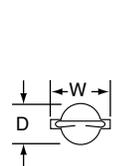

MNU18-187DFI

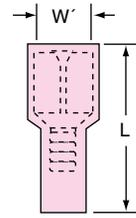

MNU18-250DFI

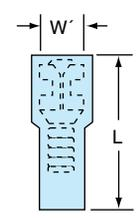

MNU14-187DFI

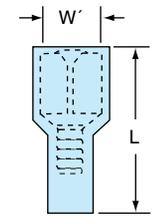

MNU14-250DFI

Stud Size
Wire Range
Suggested Mate

22-18
MNU18-187DMI

22-18
MNU18-250DMI

16-14
MNU14-187DMI

16-14
MNU14-250DMI

¹Product number ending in X = box; product number ending with K = bulk.

3M™ Female Disconnects — Nylon Fully Insulated with Insulation Grip



Product Number*	UPC (054007-)	Wire Range (AWG)	Mates with Male Tab Width (W') x Thickness	L	W	D	Barrel Length	Barrel I.D.	Maximum Insulation Diameter	Terminals per: Carton	Case
MNG18-187DFIX	11704	22-18	0.187 x 0.020	0.81	0.30	0.23	0.25	0.085	0.145	100	500
MNG18-187DFIK	11816	22-18	0.187 x 0.020	0.81	0.30	0.23	0.25	0.085	0.145	—	1000
MNG18-250DFIX	11705	22-18	0.250 x 0.032	0.87	0.37	0.23	0.25	0.080	0.145	100	500
MNG18-250DFIK	02293	22-18	0.250 x 0.032	0.87	0.37	0.23	0.25	0.080	0.145	—	1000
MNG14-187DFIX	11715	16-14	0.187 x 0.020	0.81	0.30	0.23	0.25	0.085	0.145	100	500
MNG14-187DFIK	15975	16-14	0.187 x 0.020	0.81	0.30	0.23	0.25	0.085	0.145	—	1000
MNG14-250DFIX	11716	16-14	0.250 x 0.032	0.87	0.37	0.23	0.25	0.080	0.145	100	500
MNG14-250DFIK	01841	16-14	0.250 x 0.032	0.87	0.37	0.23	0.25	0.080	0.145	—	1000

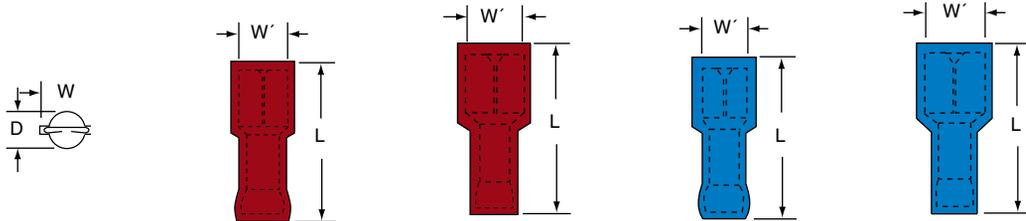

Stud Size	MNG18-187DFI	MNG18-250DFI	MNG14-187DFI	MNG14-250DFI
Wire Range	22-18	22-18	16-14	16-14
Suggested Mate	MNG18-187DMI	MNG18-250DMI	MNG14-187DMI	MNG14-250DMI

3M™ Female Disconnects — Nylon Fully Insulated Interlock Barrel



Product Number*	UPC (054007-)	Wire Range (AWG)	Mates with Male Tab Width (W') x Thickness	L	Barrel Length	Barrel I.D.	Maximum Insulation Diameter	Terminals per: Carton	Case
MNI18-250DFIX	09995	22-18	0.250 x 0.032	0.91	0.25	0.076	0.145	100	500
MNI18-250DFIK	69577	22-18	0.250 x 0.032	0.91	0.25	0.076	0.145	—	1000
MNI14-250DFIX	09993	16-14	0.250 x 0.032	0.91	0.25	0.076	0.145	100	500
MNI14-250DFIK	69575	16-14	0.250 x 0.032	0.91	0.25	0.076	0.145	—	1000
MNI10-250DFIX	09991	12-10	0.250 x 0.032	0.99	0.25	0.128	0.250	50	500
MNI10-250DFIK	69573	12-10	0.250 x 0.032	0.99	0.25	0.128	0.250	—	500

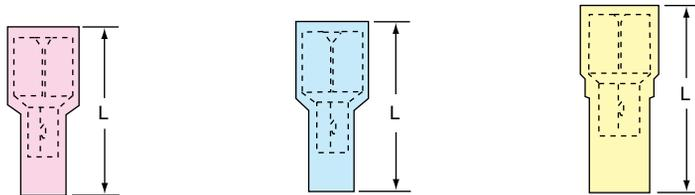

Wire Range	MNI18-250DFI	MNI14-250DFI	MNI10-250DFI
Suggested Mate	MNI18-250DMI	MNI14-250DMI	MNI10-250DMI

*Product number ending in X = box; product number ending with K = bulk.

3M™ Female Disconnects — Nylon Fully Insulated with Insulation Grip Interlock Barrel



Product Number*	UPC (054007-)	Wire Range (AWG)	Mates with Male Tab Width (W') x Thickness	L	Barrel Length	Barrel I.D.	Maximum Insulation Diameter	Terminals per: Carton	Case
MNGI18-250DFIX	09985	22-18	0.250 x 0.032	0.87	0.25	0.076	0.145	100	500
MNGI18-250DFIK	69567	22-18	0.250 x 0.032	0.87	0.25	0.076	0.145	—	1000
MNGI14-250DFIX	09983	16-14	0.250 x 0.032	0.87	0.25	0.076	0.145	100	500
MNGI14-250DFIK	69565	16-14	0.250 x 0.032	0.87	0.25	0.076	0.145	—	1000
MNGI10-250DFIX	09981	12-10	0.250 x 0.032	0.99	0.25	0.128	0.250	50	500
MNGI10-250DFIK	69563	12-10	0.250 x 0.032	0.99	0.25	0.128	0.250	—	500

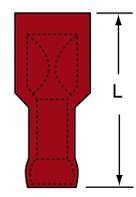

MNGI18-250DFI
Wire Range 22-18
Suggested Mate MNG18-250DMI

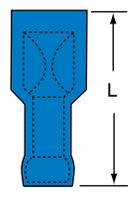

MNGI14-250DFI
Wire Range 16-14
Suggested Mate MNG14-250DMI

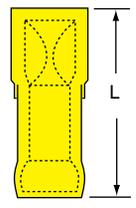

MNGI10-250DFI
Wire Range 12-10
Suggested Mate MNG10-250DMI

3M™ Female Disconnects — T-Tap Nylon Insulated Self-Stripping



Product Number*	UPC (054007-)	Wire Range (AWG)	Mates with Male Tab Width (W') x Thickness	L	M	W	Maximum Insulation Diameter	Terminals per: Carton	Case
951X	12312	22-18	0.250 x 0.032	0.73	0.44	0.38	0.150	50	500
951K	12313	22-18	0.250 x 0.032	0.73	0.44	0.38	0.150	—	1000
952X	08427	16-14	0.250 x 0.032	0.73	0.44	0.38	0.150	50	500
952K	08428	16-14	0.250 x 0.032	0.73	0.44	0.38	0.150	—	1000
953X	12314	12	0.250 x 0.032	0.73	0.44	0.38	0.150	50	500
953K	12315	12	0.250 x 0.032	0.73	0.44	0.38	0.150	—	1000



951
Wire Range 22-18
Suggested Mate MNG18-250DMI



952
Wire Range 18-16-14
Suggested Mate MNG14-250DMI



953
Wire Range 12
Suggested Mate MNG10-250DMI

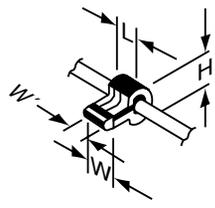

*Product number ending in X = box; product number ending with K = bulk.

3M™ Female Disconnects — Heat Shrink Nylon Fully Insulated

Product Number*	UPC (054007-)	Wire Range (AWG)	Mates with Male Tab Width (W') x Thickness	L	W	D	Barrel Length	Barrel I.D.	Terminals per: Bag	Case
MNHU18-250DFIX*	06354	22-18	0.250 x 0.032	1.2	0.37	0.23	0.25	0.080	25	100
MNHU18-250DFIK*	06355	22-18	0.250 x 0.032	1.2	0.37	0.23	0.25	0.080	—	250
MNHU14-250DFIX*	06338	16-14	0.250 x 0.032	1.2	0.37	0.23	0.25	0.080	25	100
MNHU14-250DFIK*	06339	16-14	0.250 x 0.032	1.2	0.37	0.23	0.25	0.080	—	250
MNHU10-250DFIX	06314	12-10	0.250 x 0.032	1.2	0.39	0.32	0.25	0.165	25	100
MNHI10-250DFIK	06315	12-10	0.250 x 0.032	1.2	0.39	0.32	0.25	0.165	—	250

*Windowless receptacle

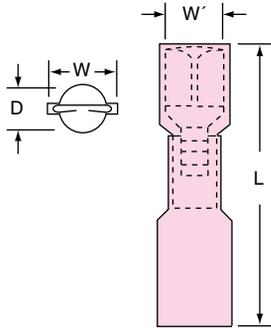

MNHU18-250DFI

Wire Range

22-18

Suggested Mate

MNHU18-250DMI

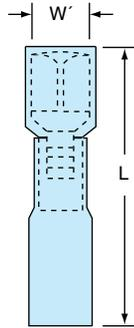

MNHU14-250DFI

16-14

MNHU14-250DMI

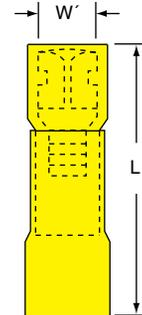

MNHI10-250DFI

12-10

MNHU10-250DMI

3M™ Female Disconnects — Fuseholder Polypropylene Insulated Self-Stripping

Product Number*	UPC (054007-)	Wire Range (AWG)	Mates with Male Tab Width (W') x Thickness	L	H	D	Maximum Insulation Diameter	Terminals per: Carton	Case
972X	06171	18-14	0.205 x 0.025	1.37	0.44	0.95	0.145	25	250
972K	06172	18-14	0.205 x 0.025	1.37	0.44	0.95	0.145	—	1000

For use with flat blade automotive type fuse of 30V or less.

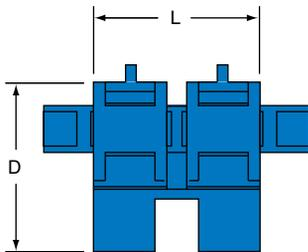

972

Wire Range

18-14

Suggested Mate

ATO Auto Fuse

*Product number ending in X = box; product number ending with K = bulk.

Male Disconnects

3M™ Male Disconnects — Non-Insulated Butted Seam



Product Number*	UPC (054007-)	Wire Range (AWG)	Male Tab Width (W') x Thickness	L	Barrel Length	Barrel I.D.	Terminals per: Carton	Case
MU18-187DMK	02372	22-18	0.187 x 0.020	0.64	0.24	0.080	—	1000
MU18-250DMK	02364	22-18	0.250 x 0.032	0.73	0.25	0.065	—	1000
MU14-187DMK	01783	16-14	0.187 x 0.020	0.64	0.24	0.080	—	1000
MU14-250DMX	22971	16-14	0.250 x 0.032	0.73	0.25	0.085	100	500
MU14-250DMK	01784	16-14	0.250 x 0.032	0.73	0.25	0.085	—	1000
MU10-250DMX	23912	12-10	0.250 x 0.032	0.75	0.25	0.150	100	500
MU10-250DMK	02056	12-10	0.250 x 0.032	0.75	0.25	0.150	—	500

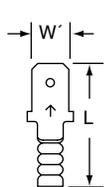

MU18-187DMK

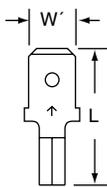

MU18-250DMK

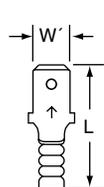

MU14-187DMK

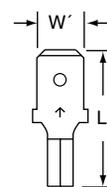

MU14-250DMK

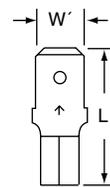

MU10-250DMK

Wire Range

22-18

22-18

16-14

16-14

12-10

Suggested Mate

MU18-187DF

MU18-250DF

MU14-187DF

MU14-250DF

MU10-250DF

3M™ Male Disconnects — Vinyl Insulated Butted Seam



Product Number*	UPC (054007-)	Wire Range (AWG)	Male Tab Width (W') x Thickness	L	Barrel Length	Barrel I.D.	Maximum Insulation Diameter	Terminals per: Carton	Case
MVU18-187DMK	02375	22-18	0.187 x 0.020	0.85	0.24	0.080	0.145	—	1000
MVU18-250DMX	11822	22-18	0.250 x 0.032	0.93	0.25	0.065	0.145	100	500
MVU18-250DMK	02376	22-18	0.250 x 0.032	0.93	0.25	0.065	0.145	—	1000
MVU14-187DMX	22989	16-14	0.187 x 0.020	0.85	0.24	0.080	0.145	100	500
MVU14-187DMK	01789	16-14	0.187 x 0.020	0.85	0.24	0.080	0.145	—	1000
MVU14-250DMX	22997	16-14	0.250 x 0.032	0.93	0.25	0.085	0.170	100	500
MVU14-250DMK	01790	16-14	0.250 x 0.032	0.93	0.25	0.085	0.170	—	1000
MVU10-250DMX	23920	12-10	0.250 x 0.032	1.05	0.25	0.150	0.250	50	500
MVU10-250DMK	02059	12-10	0.250 x 0.032	1.05	0.25	0.150	0.250	—	500

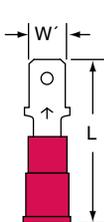

MVU18-187DMK

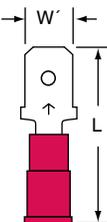

MVU18-250DMK

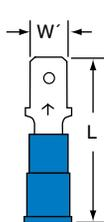

MVU14-187DMK

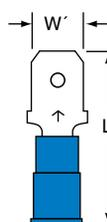

MVU14-250DMK

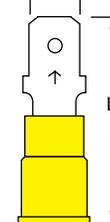

MVU10-250DMK

Wire Range

22-18

22-18

16-14

16-14

12-10

Suggested Mate

MVU18-187DF

MVU18-250DF

MVU14-187DF

MVU14-250DF

MVU10-250DF

*Product number ending in X = box; product number ending with K = bulk.

3M™ Male Disconnects — Vinyl Insulated Butted Seam Bullet Style



Product Number	UPC (051138-)	Wire Range (AWG)	Mating Snap Diameter		Maximum Insulation Diameter	Terminals per:	
			S	L		Carton	Case
MVU18-156DMK-A	98094	22-18	0.156	0.85	0.15	—	1000
MVU18-180DMK-A	98145	22-18	0.180	0.83	0.15	—	1000
MVU14-156DMX-A	98147	16-14	0.156	0.85	0.170	100	500
MVU14-156DMK-A	98149	16-14	0.156	0.85	0.170	—	1000
MVU14-180DMX-A	98160	16-14	0.180	0.83	0.171	100	500
MVU14-180DMK	98163	16-14	0.180	0.83	0.171	—	1000

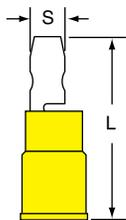

MVU18-156DM

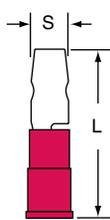

MVU18-180DM

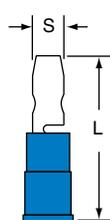

MVU14-156DM

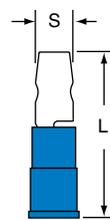

MVU14-180DM

Wire Range

22-18

22-18

16-14

16-14

Suggested Mate

MNU18-156DFI

MNU18-180DFI

MNU14-156DFI

MNU14-180DFI

3M™ Male Disconnects — Nylon Insulated with Insulation Grip



Product Number	UPC (054007-)	Wire Range (AWG)	Male Tab Width (W') x Thickness	L	Barrel Length	Barrel I.D.	Maximum Insulation Diameter	Terminals per:	
								Carton	Case
MNG18-187DMK	02377	22-18	0.187 x 0.020	0.84	0.24	0.080	0.145	—	1000
MNG18-250DMX	02365	22-18	0.250 x 0.032	0.92	0.25	0.065	0.145	100	500
MNG18-250DMK	02378	22-18	0.250 x 0.032	0.92	0.25	0.065	0.145	—	1000
MNG14-187DMX	23003	16-14	0.187 x 0.020	0.84	0.24	0.080	0.145	100	500
MNG14-187DMK	01787	16-14	0.187 x 0.020	0.84	0.24	0.080	0.145	—	1000
MNG14-250DMX	23011	16-14	0.250 x 0.032	0.94	0.25	0.085	0.170	100	500
MNG14-250DMK	01788	16-14	0.250 x 0.032	0.94	0.25	0.085	0.170	—	1000
MNG10-250DMX	23938	12-10	0.250 x 0.032	1.05	0.25	0.150	0.250	50	500
MNG10-250DMK	02058	12-10	0.250 x 0.032	1.05	0.25	0.150	0.250	—	500

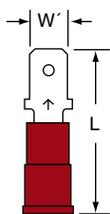

MNG18-187DM

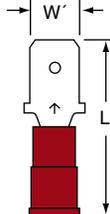

MNG18-250DM

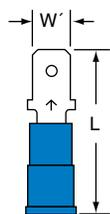

MNG14-187DM

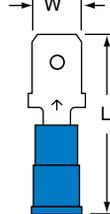

MNG14-250DM

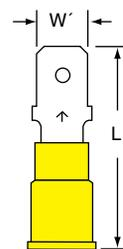

MNG10-250DM

Wire Range

22-18

22-18

16-14

16-14

12-10

Suggested Mate

MNG18-187DF

MNG18-250DF

MNG14-187DF

MNG14-250DF

MNG10-250DF

*Product number ending in X = box; product number ending with K = bulk.

3M™ Male Disconnects — Nylon Insulated with Insulation Grip Bullet Style



Product Number ¹	UPC (051138-)	Wire Range (AWG)	Mating Snap Diameter		Maximum Insulation Diameter	Terminals per:	
			S	L		Carton	Case
MNG18-156DMK-A	98088	22-18	0.156	0.87	0.15	—	1000
MNG18-180DMK-A	98100	22-18	0.180	0.87	0.15	—	1000
MNG14-156DMX-A	98139	16-14	0.156	0.87	0.19	100	500
MNG14-156DMK-A	98137	16-14	0.156	0.87	0.19	—	1000
MNG14-180DMK-A	98155	16-14	0.180	0.87	0.19	—	1000

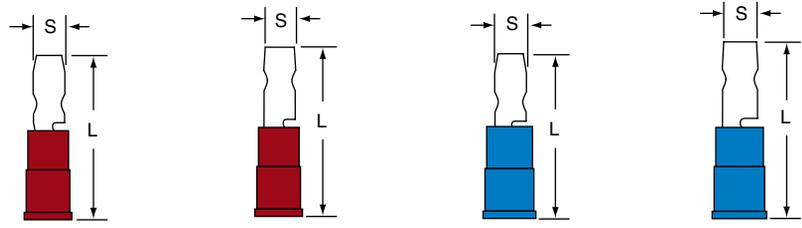

	MNG18-156DM-A	MNG18-180DM-A	MNG14-156DM-A	MNG14-180DM-A
Wire Range	22-18	22-18	16-14	16-14
Suggested Mate	MNG18-156DFI	MNG18-180DFI	MNG14-156DFI	MNG14-180DFI

3M™ Male Disconnects — Nylon Fully Insulated Butted Seam



Product Number ¹	UPC (054007-)	Wire Range (AWG)	Male Tab Width (W') x Thickness	L	W	D	Barrel Length	Barrel I.D.	Maximum Insulation Diameter	Terminals per:	
										Carton	Case
MNU18-187DMIX	02354	22-18	0.187 x 0.020	0.87	0.37	0.30	0.24	0.080	0.145	100	500
MNU18-187DMIK	02379	22-18	0.187 x 0.020	0.87	0.37	0.30	0.24	0.080	0.145	—	1000
MNU18-250DMIX	02289	22-18	0.250 x 0.032	0.95	0.44	0.30	0.25	0.065	0.145	100	500
MNU18-250DMIK	02299	22-18	0.250 x 0.032	0.95	0.44	0.30	0.25	0.065	0.145	—	1000
MNU14-187DMIX	02381	16-14	0.187 x 0.020	0.87	0.37	0.30	0.24	0.080	0.145	100	500
MNU14-187DMIK	02385	16-14	0.187 x 0.020	0.87	0.37	0.30	0.24	0.080	0.145	—	1000
MNU14-250DMIX	02306	16-14	0.250 x 0.032	0.95	0.44	0.30	0.25	0.085	0.170	50	500
MNU14-250DMIK	02300	16-14	0.250 x 0.032	0.95	0.44	0.30	0.25	0.085	0.170	—	1000
MNU10-250DMIX	02307	12-10	0.250 x 0.032	1.05	0.47	0.39	0.25	0.150	0.250	50	500
MNU10-250DMIK	02301	12-10	0.250 x 0.032	1.05	0.47	0.39	0.25	0.150	0.250	—	500

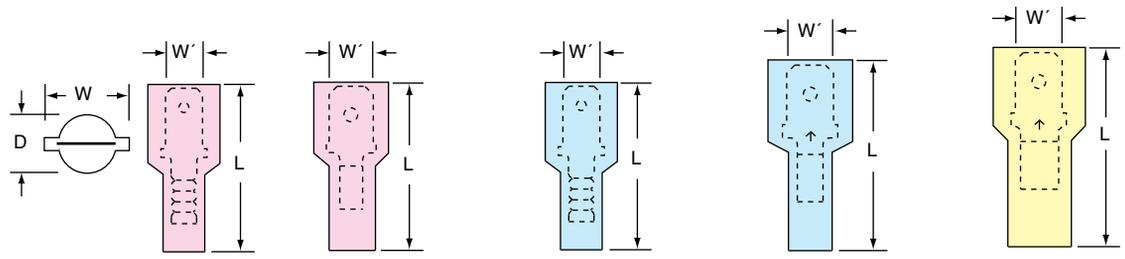

	MNU18-187DMI	MNU18-250DMI	MNU14-187DMI	MNU14-250DMI	MNU10-250DMI
Wire Range	22-18	22-18	16-14	16-14	12-10
Suggested Mate	MNU18-187DFI	MNU18-250DFI	MNU14-187DFI	MNU14-250DFI	MNU10-250DFI

¹Product number ending in X = box; product number ending with K = bulk.

3M™ Male Disconnects — Nylon Fully Insulated with Insulation Grip



Product Number	UPC (054007-)	Wire Range (AWG)	Male Tab Width (W') x Thickness	L	W	D	Barrel Length	Barrel I.D.	Maximum Insulation Diameter	Terminals per: Carton	Case
MNG18-187DMIX	11710	22-18	0.187 x 0.020	0.87	0.37	0.30	0.24	0.080	0.145	100	500
MNG18-187DMIK	11794	22-18	0.187 x 0.020	0.87	0.37	0.30	0.24	0.080	0.145	—	1000
MNG18-250DMIX	11711	22-18	0.250 x 0.032	0.95	0.44	0.30	0.25	0.065	0.145	100	500
MNG18-250DMIK	02302	22-18	0.250 x 0.032	0.95	0.44	0.30	0.25	0.065	0.145	—	1000
MNG14-187DMIX	11722	16-14	0.187 x 0.020	0.87	0.37	0.30	0.24	0.080	0.145	100	500
MNG14-187DMIK	02386	16-14	0.187 x 0.020	0.87	0.37	0.30	0.24	0.080	0.145	—	1000
MNG14-250DMIX	11723	16-14	0.250 x 0.032	0.95	0.44	0.30	0.25	0.085	0.170	100	500
MNG14-250DMIK	02249	16-14	0.250 x 0.032	0.95	0.44	0.30	0.25	0.085	0.170	—	1000
MNG10-250DMIX	11729	12-10	0.250 x 0.032	1.05	0.47	0.39	0.25	0.150	0.250	50	500
MNG10-250DMIK	02303	12-10	0.250 x 0.032	1.05	0.47	0.39	0.25	0.150	0.250	—	500

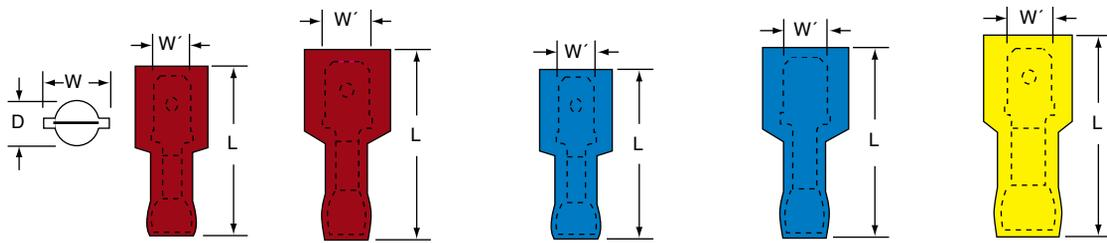

MNG18-187DMI

MNG18-250DMI

MNG14-187DMI

MNG14-250DMI

MNG10-250DMI

Wire Range

22-18

22-18

16-14

16-14

12-10

Suggested Mate

MNG18-187DFI

MNG18-250DFI

MNG14-187DFI

MNG14-250DFI

MNG10-250DFI

3M™ Male Disconnects — Heat Shrink Nylon Fully Insulated Butted Seam

Product Number	UPC (054007-)	Wire Range (AWG)	Male Tab Width (W') x Thickness	L	W	D	Barrel Length	Barrel I.D.	Terminals per: Carton	Case
MNHU18-250DMIX	06356	22-18	0.250 x 0.032	1.2	0.44	0.30	0.25	0.065	25	100
MNHU18-250DMIK	06357	22-18	0.250 x 0.032	1.2	0.44	0.30	0.25	0.065	—	250
MNHU14-250DMIX	06340	16-14	0.250 x 0.032	1.2	0.44	0.30	0.25	0.085	25	100
MNHU14-250DMIK	06341	16-14	0.250 x 0.032	1.2	0.44	0.30	0.25	0.085	—	250
MNHU10-250DMIX	06316	12-10	0.250 x 0.032	1.2	0.47	0.39	0.25	0.150	25	100
MNHU10-250DMIK	06317	12-10	0.250 x 0.032	1.2	0.47	0.39	0.25	0.150	—	250

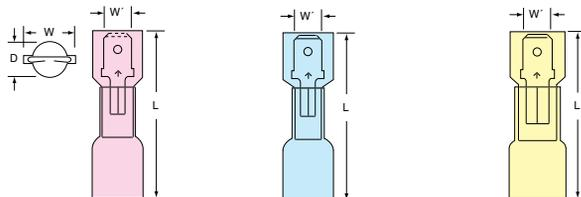

MNHU18-250DMI

MNHU14-250DMI

MNHU10-250DMI

Wire Range

22-18

16-14

12-10

Suggested Mate

MNHU18-250DFI

MNHU14-250DFI

MNHI10-250DFI

Product number ending in X = box; product number ending with K = bulk.

Flags and Multi-Stack Disconnects

3M™ Flags — Non-Insulated Ring Type



Product Number*	UPC (054007-)	Wire Range (AWG)	Stud Size	W	C	L	Thickness	Barrel Length	Barrel I.D.	Terminals per Case
MU18-6R/FLAGK	01294	22-18	6	0.38	0.34	0.66	0.030	0.26	0.070	1000

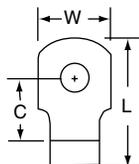

MU18-6R/FLAG

Stud Size 6
 Wire Range 22-18

3M™ Multi-Stack Disconnects — Vinyl Insulated Butted Seam

Product Number*	UPC (051138-)	Wire Range (AWG)	Mates with Female & Male Width (W') x Thickness	L	Maximum Insulation Diameter	Terminals per Carton	Case
MVU18-250DMFX-A	98063	22-18	0.250 x 0.032	0.87	0.145	100	500
MVU18-250DMFK-A	98062	22-18	0.250 x 0.032	0.87	0.145	—	1000
MVU14-250DMFX-A	98074	16-14	0.250 x 0.032	0.87	0.170	100	500
MVU14-250DMFK-A	98073	16-14	0.250 x 0.032	0.87	0.170	—	1000

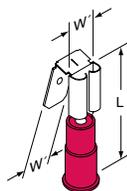

MVU18-250DMF-A

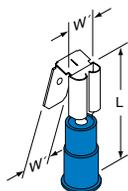

MVU14-250DMF-A

Wire Range 22-18 16-14
 Suggested Mate 0.250 Male/Female 0.250 Male/Female

*Product number ending in X = box; product number ending with K = bulk.

3M™ Multi-Stack Disconnects — Vinyl Insulated Butted Seam

Product Number [†]	UPC (051138-)	Wire Range (AWG)	Mates with Female & Male Width (W') x Thickness	L	Maximum Insulation Diameter	Terminals per Case
MNG18-250DMFX-A	98059	22-18	0.250 x 0.032	0.86	0.145	1000
MNG18-250DMFK-A	98058	22-18	0.250 x 0.032	0.86	0.145	1000
MNG14-250DMFX-A	98068	16-14	0.250 x 0.032	0.88	0.170	1000
MNG14-250DMFK-A	98067	16-14	0.250 x 0.032	0.88	0.170	1000

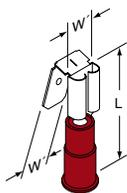

MNG18-250DMF-A

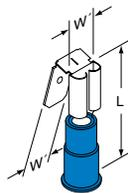

MNG14-250DMF-A

Wire Range

22-18

16-14

Suggested Mate

0.250 Male/Female

0.250 Male/Female

Adapters

3M™ Adapters — Non-Insulated Double Male-Female



Product Number [†]	UPC (054007-)	Mates with Female & Male Width (W') x Thickness	L	Terminals per: Carton	Case
MA250DMFMX-A*	57452**	0.250 x 0.032	0.78	50	500
MA250DMFMK-A*	57451**	0.250 x 0.032	0.78	—	500
MA250DMMFX	02308	0.250 x 0.032	0.76	50	500
MA250DMMFK	02273	0.250 x 0.032	0.76	—	500

* Not UL Listed or CSA Certified

** UPC prefix 051128-

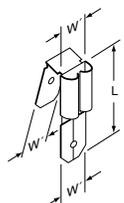

MA250DMFM-A

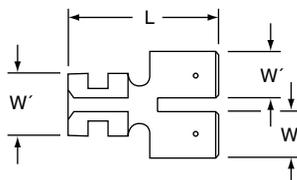

MA250DMMF

Suggested Mate

0.250 Males (2)/Female

0.250 Males (2)/Female

Suggested Mate

0.250 Male/Female

0.250 Male/Female

[†]Product number ending in X = box; product number ending with K = bulk.

3M™ Adapters — Non-Insulated Male Fuse-Clip

Product Number*	UPC (054007-)	Male Tab Width (W') x Thickness	L	Terminals per Case
MA250DM/FUSEK	02269	0.250 x 0.030	0.77	500

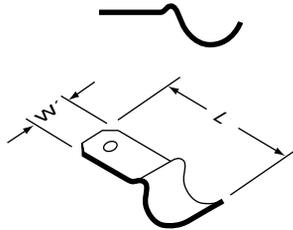

MA250DM/FUSE

Suggested Mate 0.250 Female/Fuse
 Suggested Mate 0.250 Male/Female

3M™ Adapters — Non-Insulated Male Rectangular Tongue

Product Number*	UPC (054007-)	Stud Size	Male Tab Width (W') x Thickness	W	C	L	Terminals per Case
MA250DM/6RRK	02225	6	0.250 x 0.032	0.30	0.26	0.80	500
MA250DM/8RRK	02226	8	0.250 x 0.032	0.30	0.26	0.80	500
MA250DM/10RRK	02227	10	0.250 x 0.032	0.30	0.26	0.80	500

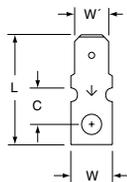

MA250DM/6RR

Suggested Mate 0.250 Female Disconnect

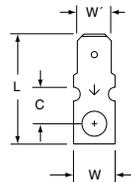

MA250DM/8RR

Suggested Mate 0.250 Female Disconnect

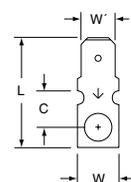

MA250DM/10RR

Suggested Mate 0.250 Female Disconnect

3M™ Adapters — Vinyl Insulated Double Female Disconnect

Product Number*	UPC (054007-)	Male Tab Width (W') x Thickness	L	Terminals per Case
MVA156DFFIK	14358	0.156	1.31	500
MVA180DFFIK	02236	0.180	1.31	500

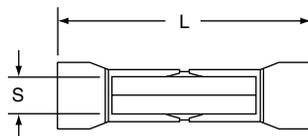

MVA156DFFI

Suggested Mate 0.156 Male Bullets
 Suggested Mate 0.250 Male/Female

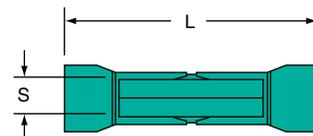

MVA180DFFI

Suggested Mate 0.180 Male Bullets
 Suggested Mate 0.250 Male/Female

*Product number ending in X = box; product number ending with K = bulk.

High Temperature

3M™ High Temperature Ring Tongues* — Butted Seam 900°F (482°C)

Product Number ¹	UPC (054007-)	Wire Range (AWG)	Stud Size	W	C	L	E	Thickness	Barrel Length	Barrel I.D.	Terminals per: Carton	Case
MU18-6RHT/SX	49607	22-18	6	0.25	0.22	0.60	0.47	0.030	0.25	0.070	100	500
MU18-6RHT/SK	01297	22-18	6	0.25	0.22	0.60	0.47	0.030	0.25	0.070	—	1000
MU18-10RHTX	49608	22-18	10	0.33	0.29	0.70	0.54	0.030	0.25	0.070	100	500
MU18-10RHTK	01155	22-18	10	0.33	0.29	0.70	0.54	0.030	0.25	0.070	—	1000
MU14-6RHT/SX	49629	16-14	6	0.25	0.22	0.60	0.47	0.030	0.25	0.090	100	500
MU14-6RHT/SK	01758	16-14	6	0.25	0.22	0.60	0.47	0.030	0.25	0.090	—	1000
MU14-10RHTX	15629	16-14	10	0.33	0.29	0.70	0.54	0.030	0.25	0.090	100	500
MU14-10RHTK	01759	16-14	10	0.33	0.29	0.70	0.54	0.030	0.25	0.090	—	1000
MU14-14RHTX	49630	16-14	1/4	0.56	0.40	0.93	0.65	0.030	0.25	0.090	100	500
MU14-14RHTK	01760	16-14	1/4	0.56	0.40	0.93	0.65	0.030	0.25	0.090	—	1000
MU10-10RHTX	15637	12-10	10	0.38	0.29	0.73	0.54	0.040	0.25	0.135	50	500
MU10-10RHTK	02045	12-10	10	0.38	0.29	0.73	0.54	0.040	0.25	0.135	—	500
MU10-14RHTK	02046	12-10	1/4	0.59	0.44	0.99	0.69	0.040	0.25	0.135	—	500
MU8-14RHT/SK	02142	8	1/4	0.47	0.40	0.95	0.71	0.050	0.31	0.185	—	200
MU6-38RHTK	02171	6	3/8	0.63	0.52	1.22	0.91	0.050	0.39	0.255	—	200
MU4-38RHTK	02196	4	3/8	0.68	0.53	1.34	1.00	0.075	0.47	0.285	—	200

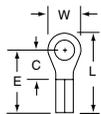

MU18-6RHT/S

Stud Size
Wire Range

6
22-18

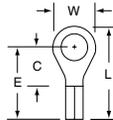

MU18-10RHT

10
22-18

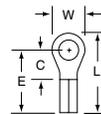

MU14-6RHT/S

6
16-14

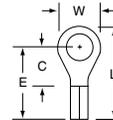

MU14-10RHT

10
16-14

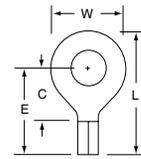

MU14-14RHT

1/4
16-14

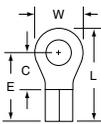

MU10-10RHT

Stud Size
Wire Range

10
12-10

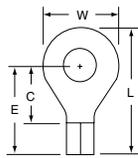

MU10-14RHT

1/4
12-10

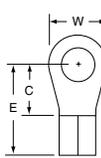

MU8-14RHT/S

1/4
8

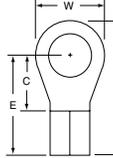

MU6-38RHT

3/8
6

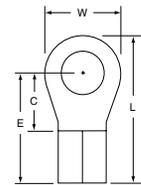

MU4-38RHT

3/8
4

*Steel with nickel plating

¹Product number ending in X = box; product number ending with K = bulk.

3M™ High Temperature Standard Forks* — Butted Seam 900°F (482°C)

Product Number [†]	UPC (054007-)	Wire Range (AWG)	Stud Size	W	C	L	E	Thickness	Barrel Length	Barrel I.D.	Terminals per Case
MU18-10FHTK	01333	22-18	10	0.34	0.29	0.70	0.54	0.030	0.25	0.070	1000
MU14-10FHTK	01842	16-14	10	0.34	0.29	0.70	0.54	0.030	0.25	0.090	1000
MU10-10FHTK	02095	12-10	10	0.38	0.28	0.73	0.53	0.040	0.25	0.135	500

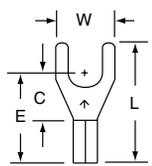

MU18-10FHT

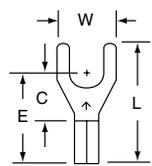

MU14-10FHT

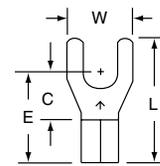

MU10-10FHT

Stud Size
Wire Range

10
22-18

10
16-14

10
12-10

3M™ High Temperature Block Forks* — Butted Seam 900°F (482°C)

Product Number [†]	UPC (054007-)	Wire Range (AWG)	Stud Size	W	C	L	E	Thickness	Barrel Length	Barrel I.D.	Terminals per Case
MU18-6FBHTK	01334	22-18	6	0.30	0.25	0.65	0.50	0.030	0.25	0.070	1000
MU14-6FBHTK	01843	16-14	6	0.30	0.25	0.65	0.50	0.030	0.25	0.090	1000

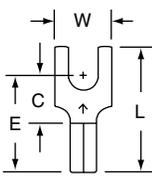

MU18-6FBHT

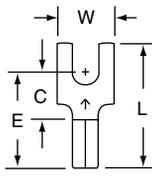

MU14-6FBHT

Stud Size
Wire Range

6
22-18

6
16-14

3M™ High Temperature Butt Connectors* — Butted Seam 900°F (482°C)

Product Number [†]	UPC (054007-)	Wire Range (AWG)	L	Thickness	Barrel Length	Barrel I.D.	Terminals per Carton	Case
MU18BCHTX	49609	22-18	0.56	0.030	0.25	0.070	100	500
MU18BCHTK	01299	22-18	0.56	0.030	0.25	0.070	—	1000
MU14BCHTX	49631	16-14	0.56	0.030	0.25	0.090	100	500
MU14BCHTK	01761	16-14	0.56	0.030	0.25	0.090	—	1000
MU10BCHTX	49645	12-10	0.56	0.040	0.25	0.135	50	500
MU10BCHTK	02232	12-10	0.56	0.040	0.25	0.135	—	500

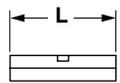

MU18BCHT

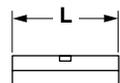

MU14BCHT

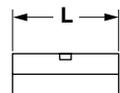

MU10BCHT

Wire Range

22-18

16-14

12-10

*Steel with nickel plating

[†]Product number ending in X = box; product number ending with K = bulk.

3M™ High Temperature Female Disconnects* — Butted Seam 900°F (482°C)

Product Number [†]	UPC (054007-)	Wire Range (AWG)	Mates with Male Tab Width (W') x Thickness	L	Barrel Length	Barrel I.D.	Terminals per: Carton	Case
MU14-187DFHTK	01762	16-14	0.187 x 0.020	0.58	0.25	0.085	—	1000
MU14-250DFHTX	49632	16-14	0.250 x 0.032	0.64	0.23	0.095	100	500
MU14-250DFHTK	01763	16-14	0.250 x 0.032	0.64	0.23	0.095	—	1000

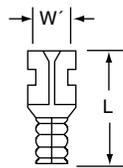

MU14-187DFHT

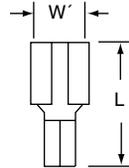

MU14-250DFHT

Wire Range

16-14

Suggested Mate

0.187 High Temperature Male Tab

16-14

MU14-250DMHT

3M™ High Temperature Female Disconnects* — Butted Seam Flag 900°F (482°C)

Product Number [†]	UPC (054007-)	Wire Range (AWG)	Mates with Male Tab Width (W') x Thickness	L	Barrel Length	Barrel I.D.	Terminals per Case
MU14-250DFHT/FLAGK	01839	16-14	0.250 x 0.032	0.51	0.26	0.095	1000

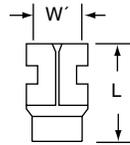

MU14-250DFHT/FLAG

Wire Range

16-14

Suggested Mate

MU14-250DMHT

3M™ High Temperature Male Disconnects* — Butted Seam 900°F (482°C)

Product Number [†]	UPC (054007-)	Wire Range (AWG)	Mates with Male Tab Width (W') x Thickness	L	Barrel Length	Barrel I.D.	Terminals per: Carton	Case
MU14-250DMHTX	49633	16-14	0.250 x 0.032	0.73	0.25	0.090	100	500
MU14-250DMHTK	01765	16-14	0.250 x 0.032	0.73	0.25	0.090	—	1000

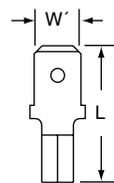

MU14-250DMHT

Wire Range

16-14

Suggested Mate

MU14-250DFHT

*Steel with nickel plating

[†]Product number ending in X = box; product number ending with K = bulk.

Closed End Connectors

3M™ Scotchlok Closed End Connector, Nylon Insulated, Copper Insert S-11-A and S-31-A

3M Scotchlok electrical crimp sleeve connectors make fast work of splicing 22 to 10 AWG copper conductors. Smooth flared entry makes wire insertion fast — simply twist conductors together and crimp. The S-11-A and S-31-A (copper) are insulated, closed-end crimp sleeve connectors. With a rugged, yet resilient nylon insulator, use these connectors in light fixtures, appliances and other electrical OEM applications.



S-11-A Solid/Stranded AWG Wire Combinations: Copper Wire Only, "CU ONLY"

WIRE COMBINATIONS

2 to 5 #22
1 to 4 #22 w/ 1 or 2 #20
1 to 3 #22 w/ 1 #18
1 #22 w/ 1 #16
2 or 3 #20

S-31-A Solid/Stranded AWG Wire Combinations: Copper Wire Only, "CU ONLY"

WIRE COMBINATIONS

1 #22 w/ 1 #12 or #10	1 #20 w/ 1 #16 w/ 1 #12
1 #22 w/ 2 #14 or #16	1 #18 w/ 1 #14
1 #22 w/ 1 #20 w/ 1 #12 or #14	1 #18 w/ 1 #12
1 #22 w/ 1 #18 w/ 1 #12 or #14	1 #18 w/ 2 #16
1 #22 w/ 1 #16 w/ 1 #12 or #14	1 #18 w/ 1 #16 w/ 1 #12 or #14
1 #22 w/ 1 #14 w/ 1 #12	1 #16 w/ 1 #12 or #14
1 or 2 #20 w/ 1 or 2 #14	3 #16
1 or 2 #20 w/ 1 #12	1 #14 w/ 1 #12
1 #20 w/ 1 #10	2 #14

Specification Information for Nylon Insulated Closed End Connectors (Copper Insert)

Product Number*	UPC (051138-)	Wire Range (AWG)	L	Maximum Voltage Range	Temperature Rating
S-11-A	98051 boxed	22-16	0.83	600V	221°F (105°C)
	98052 bulk	22-16	0.83	600V	221°F (105°C)
S-31-A	98043 boxed	18-10	1	600V	221°F (105°C)
	98044 bulk	18-10	1	600V	221°F (105°C)

Ordering Information for Nylon Insulated Closed End Connectors (Copper Insert)

Product Number	UPC (051138-)	Unit Pack	Case Qty
S-11-A	98051 boxed	100/box	100
	98052 bulk	1,000/bag	10,000
S-31-A	98043 boxed	50/box	500
	98044 bulk	500/bag	5,000

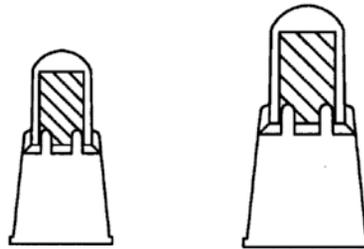

*Product number ending in X = box; product number ending with K = bulk.

Parallel Connectors

3M™ Parallel Connectors — Non-Insulated Seamless

Product Number*	UPC (054007-)	Wire Range (AWG)	Copper Wire Combinations	L	Thickness	Barrel I.D. In	Barrel I.D. CMA	Terminals per Case
M14PCK	01823	16-14	See chart below	0.31	0.024	0.091	8281	1000
M10PCK	02083	12-10	See chart below	0.34	0.024	0.152	23104	500

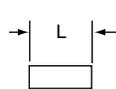

M14PC

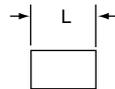

M10PC

Wire Range

16-14

12-10

RECOMMENDED STRANDED WIRE COMBINATIONS

MVU18PC

1 #22 to 1 #22, 20, 18, 16
 1 #20 to 1 #20, 18, 16
 1 #18 to 1 #18
 Min. CMA: 1280, Max. CMA: 3600

MVU10PC

1 #18 to 1 #18, 16, 14, 12, 10
 1 #16 to 1 #16, 14, 12, 10
 1 #14 to 1 #14, 12
 Min. CMA: 3240, Max. CMA: 12860

M14PC AND MVU14PC

1 #22 to 1 #22, 20, 18, 16, 14
 1 #20 to 1 #20, 18, 16, 14
 1 #18 to 1 #18, 16, 14
 1 #16 to 1 #16
 Min. CMA: 1280, Max. CMA: 5730

M10PC

1 #18 to 1 #18, 16, 14, 12, 10
 1 #16 to 1 #16, 14, 12, 10
 1 #14 to 1 #14, 12, 10
 1 #12 to 1 #12
 Min. CMA: 3240, Max. CMA: 14490

Proper Wire Insertion Parallel Connectors



3M™ Parallel Connectors — Vinyl Insulated Butted Seam

Product Number*	UPC (054007-)	Wire Range (AWG)	Copper Wire Combinations	L	Thickness	Barrel Length	Barrel I.D. In	Barrel I.D. CMA	Maximum Insulation Diameter	Terminals per Carton	Case
MVU18PCK	01318	22-18	see chart above	0.67	0.030	0.31	0.070	4900	0.145	—	1000
MVU14PCX	23144	16-14	see chart above	0.67	0.030	0.31	0.090	8100	0.170	100	500
MVU14PCK	01824	16-14	see chart above	0.67	0.030	0.31	0.090	8100	0.170	—	1000
MVU10PCK	02084	12-10	see chart above	0.87	0.040	0.31	0.135	18225	0.250	—	500



MVU18PC

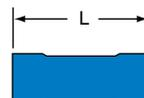

MVU14PC

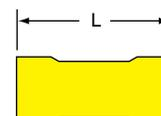

MVU10PC

Wire Range

22-18

16-14

12-10

Wire Range

22-18

16-14

12-10

*Product number ending in X = box; product number ending with K = bulk.

Pin Terminals

3M™ Pin Terminals — Non-Insulated

Product Number ¹	UPC (051125-)	Wire Range (AWG)	Pin Diameter	L	PL	Terminals per: Carton	Case
MU18-47PX	57440	22-18	0.080	0.73	0.47	100	500
MU18-47PK	57439	22-18	0.080	0.73	0.47	—	1000
MU14-47PX	57442	16-14	0.080	0.73	0.47	100	500
MU14-47PK	57441	16-14	0.080	0.73	0.47	—	1000
MU10-55PX	49420*	12-10	0.110	0.81	0.55	50	500
MU10-55PK	57443	12-10	0.110	0.81	0.55	—	500

* UPC prefix 054007-

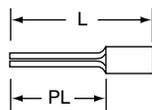

Wire Range
MU18-47P
22-18

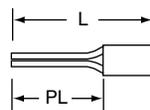

MU14-47P
16-14

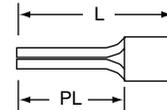

MU10-55P
12-10

3M™ Pin Terminals — Vinyl Insulated Butted Seam

Product Number ¹	UPC (051138-)	Wire Range (AWG)	Pin Diameter	L	PL	Maximum Insulation Diameter	Terminals per: Carton	Case
MVU18-47PX	98112	22-18	0.080	0.92	0.47	0.145	100	500
MVU18-47PK	98111	22-18	0.080	0.92	0.47	0.145	—	1000
MVU14-47PX	98172	16-14	0.080	0.92	0.47	0.170	100	500
MVU14-47PK	98171	16-14	0.080	0.92	0.47	0.170	—	1000
MVU10-55PX	98183	12-10	0.110	1.105	0.55	0.250	50	500
MVU10-55PK	98182	12-10	0.110	1.105	0.55	0.250	—	500

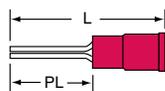

Wire Range
MVU18-47P
22-18

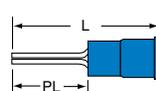

MVU14-47P
16-14

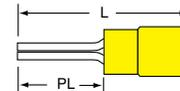

MVU10-55P
12-10

3M™ Pin Terminals — Nylon Insulated with Insulation Grip

Product Number ¹	UPC (051138-)	Wire Range (AWG)	Pin Diameter	L	PL	Maximum Insulation Diameter	Terminals per: Carton	Case
MNG18-47PX	98179	22-18	0.080	0.93	0.47	0.145	100	500
MNG18-47PK	98106	22-18	0.080	0.93	0.47	0.145	—	1000
MNG14-47PX	98167	16-14	0.080	0.91	0.47	0.170	100	500
MNG14-47PK	98166	16-14	0.080	0.91	0.47	0.170	—	1000
MNG10-55PX	98178	12-10	0.110	1.105	0.55	0.250	50	500
MNG10-55PK	98177	12-10	0.110	1.105	0.55	0.250	—	500

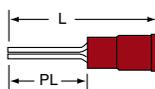

Wire Range
MNG18-47P
22-18

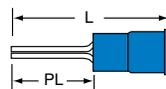

MNG14-47P
16-14

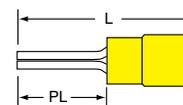

MNG10-55P
12-10

¹Product number ending in X = box; product number ending with K = bulk.

3M™ Highland™ Bagged Terminals

3M Highland terminals, disconnects, and connectors are for use in the assembly and maintenance of electrical systems. 3M Highland terminals offer effective and reliable performance in a variety of types of general applications.

Available in low quantity, reclosable bags 3M Highland terminals are the optimal choice for smaller jobs.



3M™ Highland™ Rings — Non-Insulated



Product Number*	Wire Range	Stud or Tab Size	UPC (054007-)	Terminals/Bag	Bags/Case
R10-10L	12-10	10	70320	50	5
R10-14L	12-10	1/4	70321	50	5
R10-14Q	12-10	1/4	70475	25	10
R14-4C	16-14	4	49896	100	5
R14-6C	16-14	6	70235	100	5
R14-6L	16-14	6	70322	50	10
R14-8C	16-14	8	70236	100	5
R14-8L	16-14	8	70323	50	10
R14-10L	16-14	10	70324	50	10
R18-4C	22-18	4	49902	100	5
R18-6C	22-18	6	70238	100	5
R18-6L	22-18	6	70325	50	10
R18-8C	22-18	8	70239	100	5
R18-8L	22-18	8	70326	50	10
R18-10C	22-18	10	70240	100	5

*Product Number ending in Q=25; L=50; C=100

3M™ Highland™ Rings — Vinyl Insulated



Product Number ¹	Wire Range	Stud or Tab Size	UPC (054007-)	Terminals/Bag	Bags/Case
RV10-6L	12-10	6	49893	50	5
RV10-8L	12-10	8	70328	50	5
RV10-8Q	12-10	8	70476	25	10
RV10-10L	12-10	10	70329	50	5
RV10-10Q	12-10	10	70477	25	10
RV10-14L	12-10	1/4	70330	50	5
RV10-14Q	12-10	1/4	70478	25	10
RV10-38L	12-10	3/8	70331	50	5
RV10-38Q	12-10	3/8	70479	25	10
RV10-516Q	12-10	5/16	49562	25	10
RV14-6C	16-14	6	70241	100	5
RV14-6L	16-14	6	70332	50	10
RV14-8C	16-14	8	70242	100	5
RV14-8L	16-14	8	70333	50	10
RV14-10C	16-14	10	70243	100	5
RV14-10L	16-14	10	70334	50	10
RV14-14C	16-14	1/4	70244	100	5
RV14-14L	16-14	1/4	70335	50	10
RV14-516L	16-14	5/16	49560	50	10
RV18-6C	22-18	6	70245	100	5
RV18-6L	22-18	6	70336	50	10
RV18-8C	22-18	8	70246	100	5
RV18-8L	22-18	8	70337	50	10
RV18-10C	22-18	10	70247	100	5
RV18-10L	22-18	10	70338	50	10

3M™ Highland Standard Forks — Non-Insulated



Product Number ¹	Wire Range	Stud or Tab Size	UPC (054007-)	Terminals/Bag	Bags/Case
F14-6C	16-14	6	70211	100	5
F14-10C	16-14	10	70213	100	5

¹Product Number ending in Q=25; L=50; C=100



3M™ Highland™ Standard Forks — Vinyl Insulated



Product Number*	Wire Range	Stud or Tab Size	UPC (054007-)	Terminals/Bag	Bags/Case
FV10-8L	12-10	8	70288	50	5
FV10-8Q	12-10	8	70460	25	10
FV10-10L	12-10	10	70289	50	5
FV10-10Q	12-10	10	70461	25	10
FV14-6L	16-14	6	70290	50	5
FV14-8C	16-14	8	70225	100	10
FV14-8L	16-14	8	70291	50	5
FV14-10C	16-14	10	70226	100	10
FV14-10L	16-14	10	70292	50	5

3M™ Highland Block Forks — Non-Insulated



Product Number*	Wire Range	Stud or Tab Size	UPC (054007-)	Terminals/Bag	Bags/Case
BF10-8Q	12-10	8	70448	25	10
BF10-10L	12-10	10	70250	50	5
BF10-10Q	12-10	10	70449	25	10
BF14-6L	16-14	6	70251	100	5
BF14-8C	16-14	8	70198	100	50
BF14-10C	16-14	10	70199	100	5
BF18-6C	22-18	6	70200	100	5
BF18-6L	22-18	6	70254	50	10
BF18-8C	22-18	8	70201	100	5

*Product Number ending in Q=25; L=50; C=100

3M™ Highland™ Block Forks — Vinyl Insulated



Product Number ¹	Wire Range	Stud or Tab Size	UPC (054007-)	Terminals/Bag	Bags/Case
BFV10-6L	12-10	6	49891	50	5
BFV10-8L	12-10	8	70256	50	5
BFV10-8Q	12-10	8	70450	25	10
BFV10-10L	12-10	10	70257	50	5
BFV10-10Q	12-10	10	70451	25	10
BFV14-6C	16-14	6	70202	100	5
BFV14-6L	16-14	6	70258	50	10
BFV14-8C	16-14	8	70203	100	5
BFV14-8L	16-14	8	70259	50	10
BFV14-10C	16-14	10	70204	100	5
BFV14-10L	16-14	10	70260	50	10
BFV18-6C	22-18	6	70205	100	5
BFV18-6L	22-18	6	70261	50	10
BFV18-8C	22-18	8	70206	100	5
BFV18-8L	22-18	8	70262	50	10
BFV18-10C	22-18	10	49899	100	5

3M™ Highland Locking Forks — Non-Insulated



Product Number ¹	Wire Range	Stud or Tab Size	UPC (054007-)	Terminals/Bag	Bags/Case
LF10-8Q	12-10	8	70463	25	10
LF10-10Q	12-10	10	70464	25	10
LF10-14Q	12-10	14	70465	25	10
LF14-6L	16-14	6	70293	50	10
LF14-8L	16-14	8	70294	50	10
LF18-4L	22-18	4	70296	50	10
LF18-6L	22-18	6	70297	50	10
LF18-8L	22-18	8	70298	50	10

3M™ Highland Locking Forks — Vinyl Insulated



Product Number ¹	Wire Range	Stud or Tab Size	UPC (054007-)	Terminals/Bag	Bags/Case
LFV10-6Q	12-10	6	70466	25	10
LFV10-8Q	12-10	8	70467	25	10
LFV10-10Q	12-10	10	70468	25	10
LFV10-14Q	12-10	14	70469	25	10
LFV14-6L	16-14	6	70299	50	10
LFV14-8L	16-14	8	70300	50	10
LFV14-10L	16-14	10	70301	50	10
LFV18-6L	22-18	6	70303	50	10
LFV18-8L	22-18	8	70304	50	10

¹Product Number ending in Q=25; L=50; C=100



3M™ Highland™ Butt Splices



Product Number ¹	Wire Range	Stud or Tab Size	UPC (054007-)	Terminals/Bag	Bags/Case
BS10L	12-10	NA	70263	50	5
BS10Q	12-10	NA	70452	25	10
BS14C	16-14	NA	70207	100	5
BS14L	16-14	NA	70264	50	10
BS18C	22-18	NA	70208	100	5

3M™ Highland Butt Splices — Vinyl Insulated



Product Number ¹	Wire Range	Stud or Tab Size	UPC (054007-)	Terminals/Bag	Bags/Case
BSV10L	12-10	NA	70266	50	5
BSV10Q	12-10	NA	70453	25	10
BSV14C	16-14	NA	70209	100	5
BSV14L	16-14	NA	70267	50	10
BSV18C	22-18	NA	70210	100	5
BSV18L	22-18	NA	70268	50	10

3M™ Highland Female Disconnects — Non-Insulated



Product Number ¹	Wire Range	Stud or Tab Size	UPC (054007-)	Terminals/Bag	Bags/Case
FD14-187C	16-14	.187	49894	100	5
FD14-187L	16-14	.187	49895	50	10
FD14-250C	16-14	.250	70214	100	5
FD14-250L	16-14	.250	70275	50	10
FD18-187C	22-18	.187	49900	100	5
FD18-187L	22-18	.187	49901	50	10
FD18-250L	22-18	.250	70276	50	10

¹Product Number ending in Q=25; L=50; C=100

3M™ Highland™ Female Disconnects — Vinyl Insulated



Product Number ¹	Wire Range	Stud or Tab Size	UPC (054007-)	Terminals/Bag	Bags/Case
FDV10-250L	12-10	.250	70282	50	5
FDV10-250Q	12-10	.250	70458	25	10
FDV14-187C	16-14	.187	70220	100	5
FDV14-187L	16-14	.187	70283	50	10
FDV14-250C	16-14	.250	70221	100	5
FDV14-250L	16-14	.250	70284	50	10
FDV18-187C	22-18	.187	70222	100	5
FDV18-187L	22-18	.187	70285	50	10
FDV18-250C	22-18	.250	70223	100	5
FDV18-250L	22-18	.250	70286	50	10

3M™ Highland Female Disconnects — Nylon Fully Insulated



Product Number ¹	Wire Range	Stud or Tab Size	UPC (054007-)	Terminals/Bag	Bags/Case
FDI10-250L	12-10	.250	70277	50	5
FDI10-250Q	12-10	.250	70457	25	10
FDI14-187L	16-14	.187	70278	50	10
FDI14-250C	16-14	.250	70217	100	5
FDI14-250L	16-14	.250	70279	50	10
FDI18-187C	22-18	.187	70218	100	5
FDI18-187L	22-18	.187	70280	50	10
FDI18-250C	22-18	.250	70219	100	5
FDI18-250L	22-18	.250	70281	50	10

3M™ Highland Male Tabs — Non-Insulated



Product Number ¹	Wire Range	Stud or Tab Size	UPC (054007-)	Terminals/Bag	Bags/Case
MT10-250Q	12-10	.250	70470	25	10
MT14-250L	16-14	.250	70306	50	10
MT18-187L	22-18	.187	70307	50	10
MT18-250L	22-18	.250	70308	50	10

¹Product Number ending in Q=25; L=50; C=100



3M™ Highland™ Male Tabs — Nylon Fully Insulated



Product Number*	Wire Range	Stud or Tab Size	UPC (054007-)	Terminals/Bag	Bags/Case
MTI10-250L	12-10	.250	70309	50	5
MTI10-250Q	12-10	.250	70471	25	10
MTI14-187C	16-14	.187	70227	100	5
MTI14-187L	16-14	.187	70310	50	10
MTI14-250C	16-14	.250	70228	100	5
MTI14-250L	16-14	.250	70311	50	10
MTI18-187C	22-18	.187	70229	100	5
MTI18-187L	22-18	.187	70312	50	10
MTI18-250L	22-18	.250	70313	50	10

3M™ Highland Male Tabs — Vinyl Insulated



Product Number*	Wire Range	Stud or Tab Size	UPC (054007-)	Terminals/Bag	Bags/Case
MTV10-250L	12-10	.250	70314	50	5
MTV10-250Q	12-10	.250	70472	25	10
MTV14-187C	16-14	.187	70231	100	5
MTV14-250C	16-14	.250	70232	100	5
MTV14-250L	16-14	.250	70316	50	10
MTV18-187C	22-18	.187	70233	100	5
MTV18-187L	22-18	.187	70317	50	10
MTV18-250L	22-18	.250	70318	50	10

3M™ Highland Snap Plugs — Vinyl Insulated



Product Number*	Wire Range	Stud or Tab Size	UPC (054007-)	Terminals/Bag	Bags/Case
SPV14-156L	16-14	.156	70342	50	10
SPV18-156L	22-18	.156	70343	50	10

3M™ Highland Snap Receptacles — Nylon Fully Insulated



Product Number*	Wire Range	Stud or Tab Size	UPC (054007-)	Terminals/Bag	Bags/Case
SRI14-156L	16-14	.156	70340	50	10

*Product Number ending in Q=25; L=50; C=100

Kits

3M™ Scotchlok™ Terminal Kit STK-1 (Filled)

The Scotchlok Terminal Kit is filled with 3M's most frequently purchased low voltage termination products, including 14 of our most popular terminals.



The STK-1 is constructed of durable metal with individual product compartments. While the compartments keep you organized, the rugged metal frame protects the contents even in the harshest environment. Overall box size is 13-3/4" L x 10" W x 2-1/2" H

Product	UPC 051138-	Color	Boxes/ Bag	Boxes/ Case
Scotchlok Terminal Box STK-1	25348	Red	N/A	1

Contents of STK-1

Product	Quantity
Scotchlok Crimping Tool TH-440	1
3M™ ScotchCode™ Tape Dispenser STD-0-9	1
3M Cable Ties 06225	100
3M Cable Ties 06226	100
3M Highland™ Ring Tongue Terminal RV18-6	50
3M Highland Ring Tongue Terminal RV18-8	50
3M Highland Ring Tongue Terminal RV14-6	50
3M Highland Ring Tongue Terminal RV14-8	50
3M Highland Ring Tongue Terminal RV14-10	50
3M Highland Ring Tongue Terminal RV10-10	25
3M Highland Block Fork Terminals BFV14-8	50
3M Highland Block Fork Terminals BFV14-10	50
3M Highland Block Fork Terminals BFV18-8	50
3M Highland Block Fork Terminals BFV18-6	50
3M Highland Butt Connectors BSV18	50
3M Highland Butt Connectors BSV14	50
3M Highland Butt Connectors BSV10	25
3M Highland Female Disconnects FDV14-250	50

3M™ Scotchlok™ Steel Terminal Box (Empty)

This metal case with plastic insert tray is divided into 14 terminal compartments, one tool compartment and two miscellaneous compartments. Order contents separately. Overall box size is 13-3/4" L x 10" W x 2-1/2" H



Product	UPC (054007-)	Color	Boxes/ Bag	Boxes/ Case
Scotchlok Steel Terminal Box	11900	Red	1	6
Note: Box only				

3M™ Scotchlok™ Plastic Terminal Box (Empty)

This is a plastic organizing box for terminals. It is divided into 13 compartments, including one size to hold a crimping tool. Order contents separately. Overall box size is 11" L x 7" W x 1-3/4" H.



Product	UPC (054007-)	Color	Boxes/ Bag	Boxes/ Case
Scotchlok Plastic Terminal Box	02351	Clear	1	24
Note: Box only				

Tools

3M™ Scissors, Style TH-440

A compact, high-quality tool designed to perform the six most common electrical wiring functions.

- Made of 1.125" (28,57 mm) heat-treated carbon steel
- Handles a variety of terminal and connector styles, insulated and non-insulated
- Range of 22–10 AWG
- 3M Terminals and Connectors are UL Listed and CSA Certified when used with the TH-440

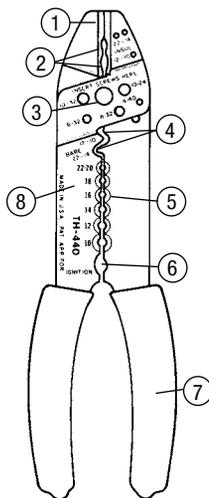

Features:

1. Anvil-type wire cutter for clean cuts.
2. Crimp dies for 22–10 AWG insulated terminals, connectors and closed-end connectors.
3. Cut-off dies for mild steel and non-ferrous screws.
4. Crimp dies for 22–10 AWG non-insulated terminals and connectors.
5. Wire stripping stations for circumferential cut-less effort.
6. Crimp die for 7 and 8 mm ignition parts.
7. Cushioned, vinyl grips, red.

For specific tooling applications, refer to the smallest units container or the Tool Selection Guides in the Appendix.

Product Number (add package code when ordering)	UPC (054007-)	Color	Boxes/ Bag	Boxes/ Case
TH-440	60825	22-10	1	10

3M™ Scissors, Style TH-450

The most versatile heavy-duty tool we've ever offered.

- Made of 1.40" (35,5 mm) high-strength, heat-treated carbon steel
- Tool is lightweight without sacrificing strength
- Handles a variety of terminal and conductor styles, including flags, closed-end connectors, crimp sleeves and standard parts, insulated and non-insulated
- Range of 26–6 AWG
- 3M Terminals and Connectors are UL Listed and CSA Certified when crimped with the TH-450

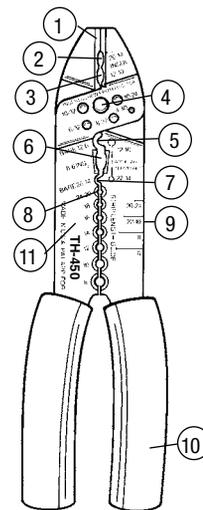

Features:

1. Anvil-type wire cutter.
- 2–3. Crimp dies for 26–10 AWG insulated terminals and closed-end connectors.
4. Cut-off dies for mild steel and non-ferrous screws.
5. Crimp dies for 12–6 AWG non-insulated terminals, connectors, flags, disconnects, crimp sleeves and high-temperature terminals.
6. Crimp dies for 6–8 AWG insulated terminals and butt connectors.
7. Crimp die for 26–14 AWG non-insulated terminals, connectors, flags, disconnects and crimp sleeves.
8. Wire-stripping stations for circumferential cut-less effort.
9. Strip length guide.
10. Textured, cushioned grips, red.

For specific tooling applications, refer to the smallest unit container or the Tool Selection Guides in the Appendix.

Product Number (add package code when ordering)	UPC (054007-)	Color	Boxes/ Bag	Boxes/ Case
TH-450	13760	26-6	1	10

*Product number ending in X = box; product number ending with K = bulk.

3M™ Ratchet TR-482

Tool Capability:

Crimps barrel and insulation grip simultaneously on No. 22–10 AWG (0,35–6,0 mm²) insulated terminals and connectors. Will crimp nylon or vinyl insulated, butted or brazed seam terminals and connectors.

Crimping Dies:

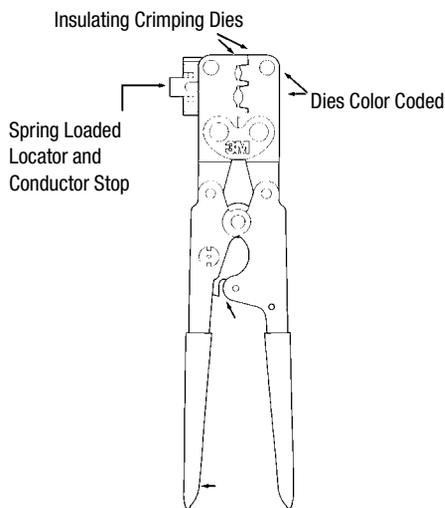

No. 22–14 AWG (0,35–2,5 mm²) red and blue color coded

No. 12–10 AWG (4,0–6,0 mm²) yellow color coded

Field Re-calibration:

Calibration of ratchet can be accomplished in the field. See calibration and maintenance instructions packaged with the tool.

Terminal Locator:

Spring loaded locator orients, positions and holds terminals and connectors.

Conductor Stop:

Provides proper insertion of conductor in the terminal barrel.

Positive Closure:

Ratchet requires full closure of handles to ensure proper crimp.

Materials and Finish:

Hardened steel jaws and handles with corrosion resistant finish.

Weight:

1.1 lbs.

Grip:

Plastic, red color

Specifications:

Insulated terminals from 22–10 AWG should be crimped with a positive action ratchet tool and be UL Listed with that tool. The dies are of a smooth, contour shape and crimp the conductor barrel and insulation grip simultaneously. The tool has a locator that will orient the terminal, position the terminal for crimping, hold the terminals in place, and act as a wire stop. The tool is compound lever type with a ratchet mechanism to ensure positive closure for full crimping cycle. The tool is capable of field adjustment to proper calibration with common tools and materials specified in the maintenance and calibration section of the instruction booklet provided with the tool. The manufacturer provides a guide for maintenance procedure and instructions to field inspect for specified die gaps. Jaws should be hardened steel and coated with a corrosion resistant finish. Tool should be a Scotchlok™ TR-482.

3M™ Terminals and Connectors are UL Listed and CSA Certified with the TR-482. For specific tooling information, see Tool Selection Guide in the Appendix

Product	UPC (054007-)	Wire Range	Tools/ Carton	Tools/ Case
TR-482	11902	22-10	1	10

3M™ Ratchet TR-490

Tool Capability:

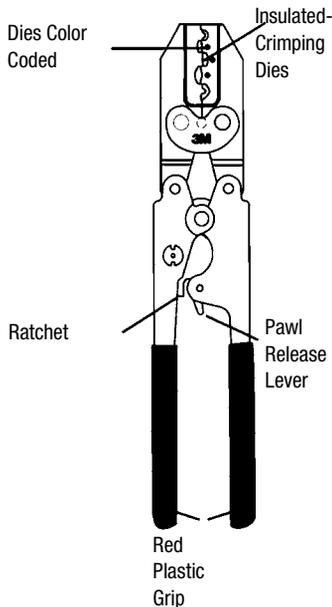

Tool Capability:

Crimps barrel and insulation grip independently on No. 22–10 AWG (0,35–6,0 mm²) insulated and non-insulated terminals and connectors—nylon or vinyl insulated, butted or brazed seam.

Crimping Dies:

Insulated No. 22–18 AWG (0,35–0,97 mm²) red color coded

Insulated No. 16–14 AWG (1,3–25 mm²) blue color coded

Insulated No. 12–10 AWG (4,0–6,0 mm²) yellow color coded

Non-Insulated No. 22–14 AWG (0,35–2,5 mm²)

Non-Insulated No. 12–10 (4,0–6,0 mm²)

Field Re-calibration:

Calibration adjustment of ratchet can be accomplished in the field. See calibration and maintenance instructions packaged with the tool.

Positive Closure:

Ratchet requires full closure of handles to ensure proper crimp. Ratchet release lever allows removal of misplaced terminals.

Materials and Finish:

Hardened steel jaws and handles with corrosion resistant finish.

Weight:

0.8 lbs.

Grip:

Plastic, red color

Specifications:

Non-insulated and insulated terminals and connectors from 22–10 AWG should be crimped with a positive action (ratchet) tool and be UL Listed with that tool. Non-insulated die is of an indent shape and insulated die is a flat, smooth shape capable of crimping pre-insulated vinyl and nylon terminals and connectors. Dies are marked with the appropriate wire range and insulated dies are color coded: red for 22–18 AWG, blue for 16–14 AWG, and yellow for 12–10 AWG. The tool is compound lever type with a ratchet mechanism to ensure positive closure for full crimping cycle. Tool is capable of field adjustment to proper calibration with common tools and materials specified in the maintenance and calibration section of the instruction booklet provided with the tool. The manufacturer provides a guide for maintenance procedure and instructions to field inspect for specified die gaps. Jaws should be hardened steel and coated with a corrosion resistant finish. Tool should be a 3M Scotchlok TR-490.

3M™ Terminals and Connectors are UL Listed and CSA Certified with the TR-490. For specific tooling information, see Tool Selection Guide in the the Appendix

Product	UPC (054007-)	Wire Range	Tools/ Carton	Tools/ Case
TR-490	70481	22-10	1	10

3M™ Terminal Stud Size Chart

	Stud Size			3M Terminal Hole Diameter	
	US/Inches	Diameter	OUS/Metric		
#2		0.086" (2,144 mm)	M2	 2,0 mm (0.080")	0.095" (2,4 mm)
#4		0.112" (2,844 mm)	M2,5	 2,5 mm (0.100")	0.120" (3,0 mm)
#5		0.125" (3,175 mm)	M3	 3,0 mm (0.120")	0.148" (3,8 mm)
#6		0.138" (3,505 mm)	M3,5	 3,5 mm (0.140")	0.148" (3,8 mm)
#8		0.164" (4,166 mm)	M4	 4,0 mm (0.176")	0.174" (4,4 mm)
#10		0.190" (4,826 mm)	M5	 5,0 mm (0.20")	0.200" (5,1 mm)
1/4		0.250" (6,350 mm)	M6	 6,0 mm (0.24")	0.265" (6,7 mm)
5/16		0.3125" (7,938 mm)	M8	 8,0 mm (0.32")	0.328" (8,3 mm)
3/8		0.375" (9,525 mm)	M10	 10,0 mm (0.40")	0.397" (10,1 mm)
7/16		0.4375" (11,113 mm)	M10	 10,0 mm (0.48")	0.450" (11,4 mm)
1/2		0.500" (12,700 mm)	M12	 12,0 mm (0.48")	0.515" (13,1 mm)
5/8		0.625" (15,875 mm)	M16	 16,0 mm (0.64")	0.656" (16,7 mm)
3/4		0.750" (19,050 mm)	M18	 18,0 mm (0.72")	0.781" (19,8 mm)

Ref: ISO 263-1973 for inch stud sizes and ISO 262-1973 for metric stud sizes

American Wire Gauge

Size	Inches	Millimeters	Size	Inches	Millimeters	Size	Inches	Millimeters
4/0	0.4600	11,684	4	0.2043	5,189	16	0.0508	1,290
3/0	0.4096	10,040	6	0.1620	4,115	18	0.0403	1,024
2/0	0.3648	9,266	8	0.1285	3,264	20	0.0320	0,813
1/0	0.3249	8,253	10	0.1019	2,588	22	0.0253	0,643
1	0.2893	7,347	12	0.0808	2,052	24	0.0201	0,511
2	0.2576	6,543	14	0.0641	1,628	26	0.0159	0,404