

3M™ Boardmount Socket

2 mm x 2 mm Right Angle, Surface Mount

950 Series



- Optimizes use of PC board space
- High temperature dielectric
- “No lead” reflow solder compatible
- Dual row design, 6–50 pins
- Mates with pin-strip header products
- RoHS Compliant. See the Regulatory Information Appendix (RIA) in the RoHS compliance section of www.3Mconnectors.com for compliance information (RIA E1 & C1 apply)

Date Modified: November 26, 2012

TS-2167-F
Sheet 1 of 2

Physical

Insulation

Material: High Temperature Thermoplastic
Flammability: UL 94V-0
Color: Black

Contact

Material: Copper Alloy

Plating

Underplating: 1.25–2.5 μm [5–10 μin] Nickel
Wiping Area: Flash Gold
Solder Tail Area: 1–3 μm [40–110 μin] Matte Tin

Electrical

Current Rating: 1 A
Insulation Resistance: $> 5 \times 10^8$ Ohm at 100 V_{DC}
Withstanding Voltage: 1000 V_{DC}
Transition Resistance: ≤ 20 mOhm

Environmental

Temperature Range: -40 °C to +105 °C
Processing Temperature: max. 260 °C (Profile per J-STD-020C)
Moisture Sensitivity Level: 1 (per J-STD-020C)

UL File No.: E68080

3M™ Boardmount Socket

2 mm x 2 mm Right Angle, Surface Mount

950 Series

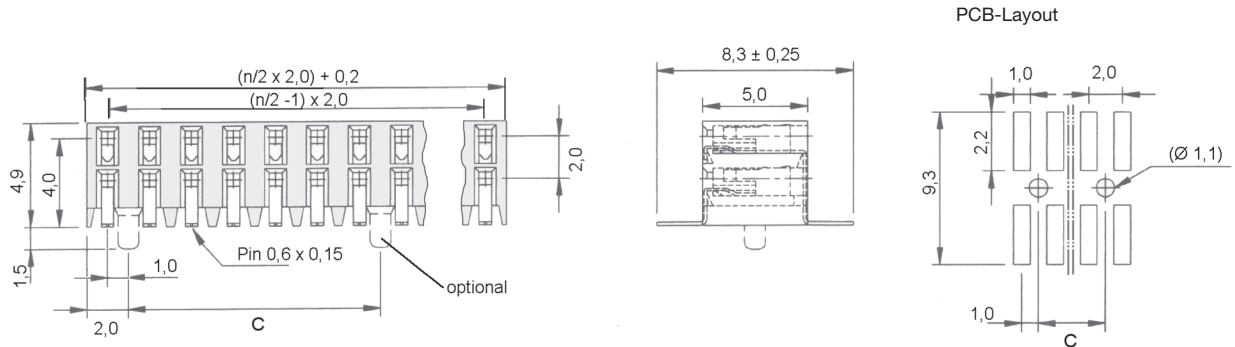

Dimensions (mm)								
Contacts			10	12	14	16	18	20
C			4.0	4.0	6.0	8.0	10.0	12.0
Contacts	22	24	26	28	30	32	34	36
C	14.0	16.0	18.0	20.0	22.0	24.0	26.0	28.0
Contacts	38	40	42	44	46	48	50	
C	30.0	32.0	34.0	36.0	38.0	40.0	42.0	

Tape & Reel Option							
9504xx-8200	Contact Quantity	6	8-14	16-20	22-30	32-44	50
9504xx-8220		-	10-14	16	-	-	-
Tape Width [mm]		16	24	32	44	56	72

n = No. of Contacts

Tolerance Unless Noted [mm]				
Nominal Size	0.5-3	3-6	6-30	30-120
Linear Dim	+/- 0.1	+/- 0.1	+/- 0.2	+/- 0.3
Radii	+/- 0.2	+/- 0.5	+/- 1	+/- 1

Ordering Information

9504XX - 82X0 - AR - XX (RIA E1 & C1 Apply)

Contact Quantity:
06-50 Pins

Tail Style:
8 = Right Angle,
Surface Mount

Packaging:
TP = Tube
TR = Tape & Reel

Board Location Features:
0 = None
2 = with Board Loc. Posts
(6-16 Contacts / others on Request)

TS-2167-F
Sheet 2 of 2

DISCONTINUED 1/17

Important Notice

All statements, technical information, and recommendations related to 3M's products are based on information believed to be reliable, but the accuracy or completeness is not guaranteed. Before using this product, you must evaluate it and determine if it is suitable for your intended application. You assume all risks and liability associated with such use. Any statements related to the product which are not contained in 3M's current publications, or any contrary statements contained on your purchase order shall have no force or effect unless expressly agreed upon, in writing, by an authorized officer of 3M.

Warranty; Limited Remedy; Limited Liability.

This product will be free from defects in material and manufacture for a period of ninety (90) days from the time of purchase. **3M MAKES NO OTHER WARRANTIES INCLUDING, BUT NOT LIMITED TO, ANY IMPLIED WARRANTY OF MERCHANTABILITY OR FITNESS FOR A PARTICULAR PURPOSE.** If this product is defective within the warranty period stated above, your exclusive remedy shall be, at 3M's option, to replace or repair the 3M product or refund the purchase price of the 3M product. **Except where prohibited by law, 3M will not be liable for any indirect, special, incidental or consequential loss or damage arising from this 3M product, regardless of the legal theory asserted.**



3M Electronics Solutions Division

6801 River Place Blvd.
Austin, TX 78726-9000
U.S.A.
1-800-225-5373
www.3Mconnectors.com

Please recycle. Printed in USA.
© 3M 2012. All rights reserved.
RIA-2217B-E

3M is a trademark of 3M Company.