

Customer : **GL8Z0**

SPECIFICATION FOR APPROVAL

Customer P/N			
Description			
Drawing No.			
3L P/N	PQ2620-T-3.2MH-W5		
Date	2019/07/24	Rev.	XA
Customer	Approved For Customer		
Seller	Drawn	Checked	Approved
			

Please Return After Approving



3L ELECTRONIC CORPORATION

Headquarters: 3L ELECTRONIC (ZHONG SHAN) CORP.

URL: <http://www.3lcoil.com>

ADD: No 6 Industrial Park Nanlang Town Zhongshan Guangdong,P.R.China

Customer:	GL8Z0	Customer P/N:	
-----------	-------	---------------	--

1.Mechanical Dimension: DRAW NO:

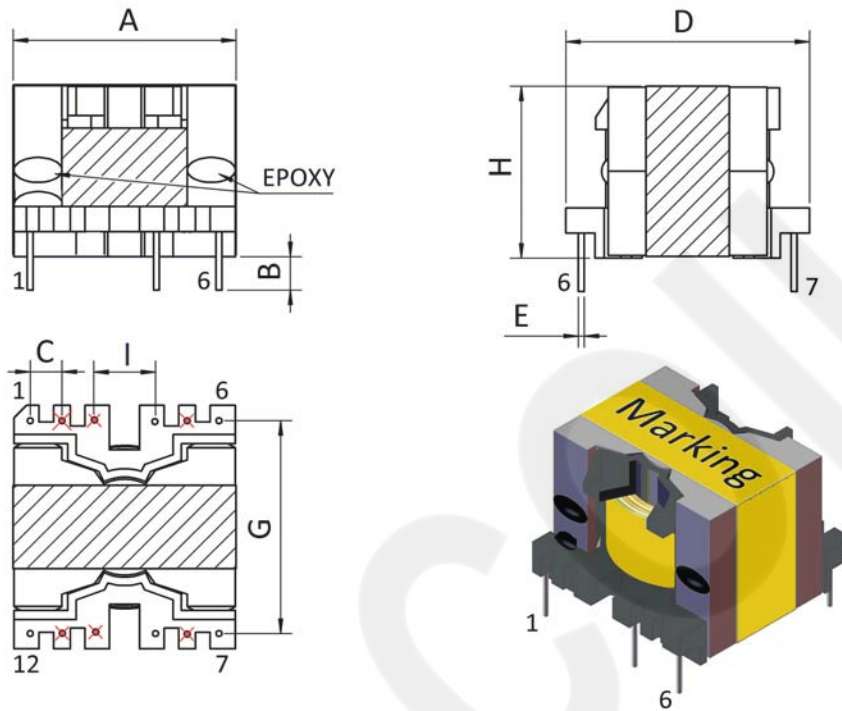

Item	Spec.(mm)	Typ.(mm)	Item	Spec.(mm)	Typ.(mm)
A	28.0 MAX	27.01	F		
B	4.0±0.5	3.97	G	25.5±0.50	25.52
C	3.8±0.5	3.78	H	22.0 MAX	21.05
D	30.5MAX	29.7	I	7.6±0.5	7.56
E	0.60±0.10	0.59	J		

Notes:

- 1.印字在產品頂部，字腳朝PIN1-6側，MARKING:
PQ2620-3.2MH
3L YYWW(年份/週期)
- 2.剪除PIN 2\3\5\8\10\11
- 3.製品真空浸漆處理.
- 4.磁芯與磁芯，磁芯與骨架之間需點膠固定.

3L P/N :	PQ2620-T-3.2MH-W5	Rev.	XA	Date:	2019/07/24
----------	-------------------	------	----	-------	------------

Customer:	GL8Z0	Customer P/N:	
-----------	-------	---------------	--

SCHEMATIC

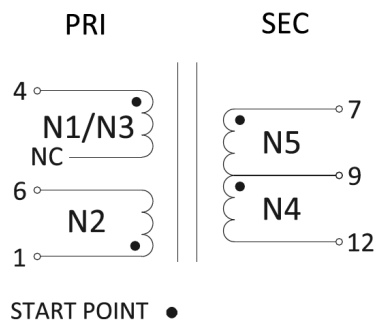

CONSTRUCTION

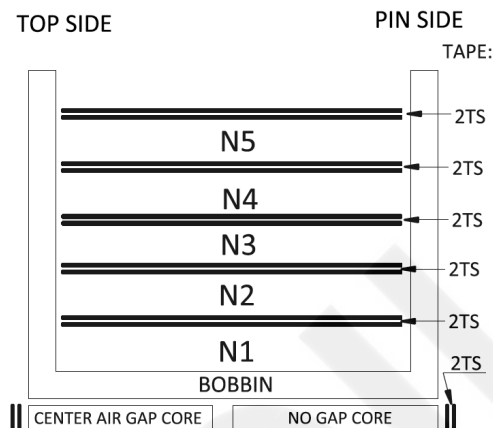

WINDING

NO.	Start	Finsh	Wire	Turns	Tape Layer(s)	Note
N1	4	/	2UEW-F, Ø0.40mm*1P(RED)	18	2	Evenly winding
N2	1	6	2UEW-F, Ø0.50mm*1P(GOD)	8	2	Evenly winding
N3	4	/	2UEW-F, Ø0.40mm*1P(RED)	18	2	Evenly winding
N4	9	12	2UEW-F, Ø0.40mm*1P(GOD)	22	2	Close winding
N5	7	9	2UEW-F, Ø0.40mm*1P(RED)	15	2	Evenly winding

2. Electrical Characteristics (at 25degC / RH 65% unless otherwise specified):

Test Item	Specifications	Test conditions	Typ.	Test Instrument
L(9-12)	3.20 mH ± 25%	@10KHz 1V	3.33mH	Agilent4284A
DCR(9-12)	220mΩMAX		180mΩ	ChenHwa502
DCR(7-9)	180mΩMAX		133mΩ	ChenHwa502
DCR(1-6)	56mΩMAX		42mΩ	ChenHwa502
T/R'POL'+	P(1-6):(9-12):(7-9) = 8Ts:22Ts:15Ts ± 0.5Ts	@20KHz 1V		TH2818XB
Hi-pot test	@1.5KV AC/3mA/50Hz/3sec	N2 TO N4/N5	PASS	Extech7142
Ope.Temp.	-20 TO +85°C			Testo608-H2
Weight	39.2g/pcs			

Notes :

3L P/N :	PQ2620-T-3.2MH-W5	Rev.	XA	Date:	2019/07/24
----------	-------------------	------	----	-------	------------

Customer:	GL8Z0	Customer P/N:	
-----------	-------	---------------	--

SHAPE AND SIZE

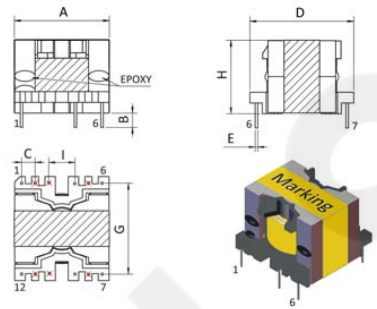
DATE:	2019/07/24			
TRA NO.	H1900018			
DRAW NO				
TEST FREQ.	L@10KHZ1V			
WIRE	0.4 mm	TURN	22.0 Ts	
TEMP	25.0 °C	HUMI.	55.0 %RH	

ELECTRICAL CHARACTERISTICS AND DIMENSIONS TEST DATA:

Dimensions unit in mm

ITEM	L(9~12)	DCR(9~12)	DCR(7~9)	DCR(1~6)
SPEC	3.2mH+/-25%	220mΩMAX	180mΩMAX	56mΩMAX
MAX	4.000	220.000	180.000	56.00
MIN	2.400			
1	3.240	178.450	132.820	42.38
2	3.360	180.630	133.560	43.28
3	3.390	182.060	133.580	42.87
4	3.410	180.920	134.830	41.59
5	3.460	179.070	134.320	43.44
6	3.250	181.910	135.010	41.59
7	3.300	181.100	132.900	41.69
8	3.220	180.060	132.080	42.26
9	3.350	182.130	134.310	42.63
10	3.320	182.100	133.200	41.85
\bar{X}	3.330	180.843	133.661	42.35
R	0.240	3.680	2.930	1.85
JUD.	OK	OK	OK	OK
OTHER ITEMS	Hi-pot test@1.5KV AC/3mA/50Hz/3sec			RESULT
				OK

TEST EQUIPMENTS :

- Agilent4284A Precision LCR Meter
- ChenHwa502 Milliohm Meter
- Extech7142 Hipot/Insulation Tester

3L P/N :	PQ2620-T-3.2MH-W5	Rev.	XA	Date:	2019/07/24
----------	-------------------	------	----	-------	------------

Customer:	GL8Z0	Customer P/N:	
-----------	-------	---------------	--

SHAPE AND SIZE

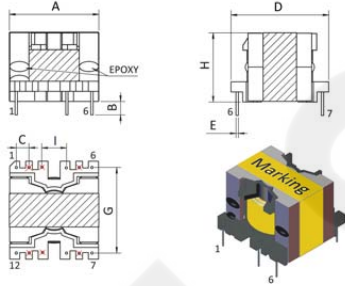
DATE:	2019/07/24			
TRA NO.	H1900018			
DRAW NO				
TEST FREQ.	@10KHz /1V			
WIRE	0.4 mm	TURN	22.0 Ts	
TEMP	25.0 °C	HUMI.	55.0 %RH	

ELECTRICAL CHARACTERISTICS AND DIMENSIONS TEST DATA: Dimensions unit in mm

ITEM	A	B	D	G	H	I	C
SPEC	28.0MAX	4.0+0.5	30.5MAX	25.4+0.5	22.0MAX	7.6+0.5	3.8+0.5
MAX	28.000	4.500	30.500	25.900	22.00	8.10	4.30
MIN		3.500		25.100		7.10	3.30
1	26.800	3.970	29.580	25.590	20.52	7.35	3.85
2	26.920	3.950	29.650	25.500	21.06	7.46	3.88
3	27.220	3.940	29.650	25.320	21.05	7.44	3.89
4	26.900	3.860	29.560	25.440	21.05	7.39	3.83
5	26.890	4.060	29.590	25.470	21.04	7.43	3.90
6	27.220	3.870	29.650	25.290	21.10	7.37	3.79
7	27.100	3.880	29.570	25.510	21.05	7.48	3.96
8	26.900	3.770	29.630	25.520	21.03	7.55	3.87
9	26.990	3.890	29.590	25.390	21.11	7.47	3.91
10	26.920	3.910	29.590	25.250	21.05	7.53	3.86
\bar{X}	26.986	3.910	29.606	25.428	21.00	7.44	3.87
R	0.420	0.290	0.090	0.340	0.59	0.20	0.17
JUD.	OK	OK	OK	OK	OK	OK	OK

OTHER ITEMS RESULT

TEST EQUIPMENTS :

Digital Caliper

3L P/N :	PQ2620-T-3.2MH-W5	Rev.	XA	Date:	2019/07/24
----------	-------------------	------	----	-------	------------

Customer:	GL8Z0	Customer P/N:	
-----------	-------	---------------	--

4. Packaging Specification:

Inside Packaging:



Notes of inside packing :

Each board: 30 pcs;

包裝圖可能會使用同類產品進行方法和要求的示範，可能與實物存在偏差。

Outside Packaging:

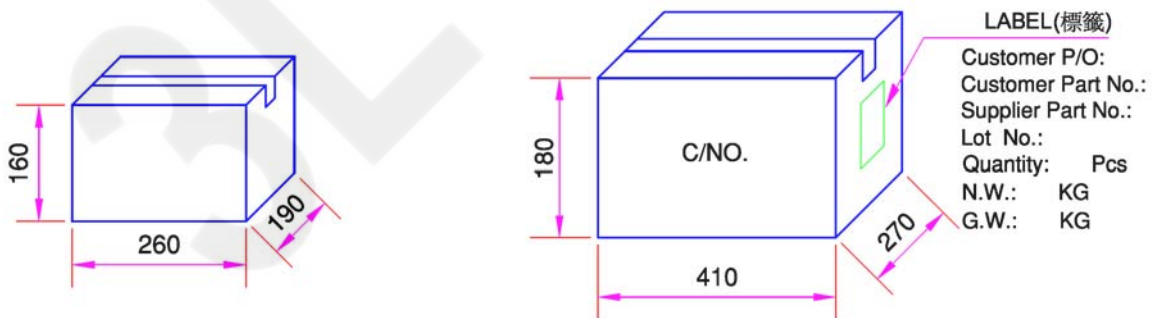

Small carton: 90 pcs; Outer carton: 180 pcs; NW.: KG; GW.: KG

Notes :

3L P/N :	PQ2620-T-3.2MH-W5	Rev.	XA	Date:	2019/07/24
----------	-------------------	------	----	-------	------------

Customer:	GL8Z0	Customer P/N:	
-----------	-------	---------------	--

Appendix 1: Lead-free the recommended Wave soldering (DIP Type)

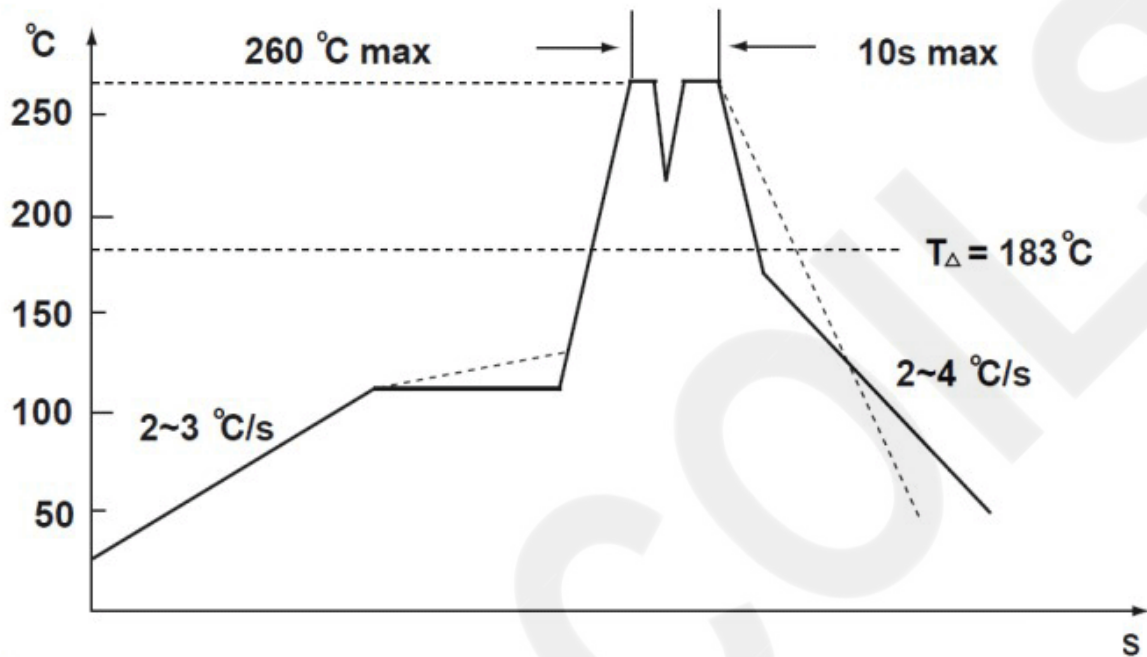

Notes:

The recommended wave soldering, is a reference to a single wave soldering recommended by the manufacturer, because the various manufacturers of soldering equipment, product process conditions, set methods and so on, when setting the soldering conditions, Please adjust and confirm according to users' environment/equipments.

Appendix 2: Soldering Iron (Rework)

1. Use a soldering iron to solder inductors by hand, times does not exceed 350 degrees 3 times.
2. When soldering iron welding, please try to avoid contacting the inductor itself. (definitely do not contact the wire)
3. To solder inductors by soldering iron is not recommended.

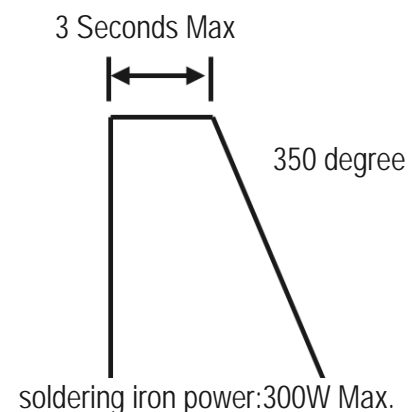

3L P/N :	PQ2620-T-3.2MH-W5	Rev.	XA	Date:	2019/07/24
----------	-------------------	------	----	-------	------------



Scope of 3L products:

1. 3L components are manufactured and promoted for applying in general electronics devices such as audio-video equipment, home electric appliance, office automation equipment, communication equipment, power module, LED lighting, measurement hardware, machine accessory, etc.
(本公司的產品使用于影音,家電,辦公自動化,通訊,電源模塊,LED照明,測量設備,機械工具等一般電子設備中.)
2. If 3L product will be applied in area like automotive product, medical equipment, military and aerospace except general electronic device, please contact 3L's sales dept. in advance. 3L shall not be held liable for any malfunction or breakdown caused by using product in the condition which is inconsistent with that recommended by 3L.
(當本公司產品使用在一般電子設備以外的場合,如:車載,醫療設備,軍用,航空航天等,請務必聯繫本公司營業部門,如超出本公司產品使用條件而引起的機器故障時,本公司概不負責.)
3. If there is problem occurring when using product or information on 3L's catalogue, which may affect industrial property or any other rights of 3L Group (or a third party), 3L Group shall not be held liable in such situation, nor grant any license to the offending party.
(在使用本公司的目錄上的產品或信息時,如發生涉及到本公司或第三者的產業財產權(工業所有權)以及其他權利的相關問題,本公司恕不負責,亦不授權給侵害方.)
4. Some parts of this publication contain statements about the suitability of our products for certain areas of application. These statements are based on our knowledge of typical requirements that are often placed on our products in the areas of application concerned. We nevertheless expressly point out that such statements cannot be regarded as binding statements about the suitability of our products for a particular customer application.
(在此處指明的一些產品包含有關我們的產品在某些應用領域的適用性陳述.這些陳述是基於我們對有關應用領域中經常放在的產品上的典型要求了解.然而,我們明確指出,這些聲明不能被視為對某些特殊的客戶運用適合的聲明.)
5. Generally, 3L might not be familiar with either customer's specification application or actual requests as customer does. As a result, customer shall be responsible for checking and confirming whether 3L product with the performance described in the product specification is suitable for using in customer's particular application or not.
(通常情況下, 3L不熟悉特定客戶的應用,也不熟悉客戶本身需求,由於這些原因,客戶始終有責任檢查并確定具有產品規格中描述的屬性的3L產品是否適合在特定客戶的應用.)
6. We also have to point out that in individual cases, any trouble or failure of electronic components happens during their long span cannot not be completely cleared even if someone operates according to instruction with existing technology.
(在個案中,我們也要指出,在現有技術中,即使按照規定進行操作,電子元件在其通常使用壽命結束之前發生故障也不能完全排除的.)
7. Please pay attention to the storage conditions that temperature: below 35°C and humidity: 35-65% RH . If product is preserved for more than 1 year, the solderability of their terminals may be deteriorated.
(產品在規定的溫度和濕度條件下保存:溫度: 35°C以下, 濕度: 35-65% RH , 如果保存期超過1年, 端子的可焊性可能會變差.)
8. The aforementioned items do not apply to individual agreements and the foregoing customer-specific products.
(上述內容不適用於個人協議和客戶上述提到的特定產品.)

Please read cautions and warnings, important notes at the end of this document.

If you have any questions, please contact us. 如有任何問題請聯繫我司.



General instruction for parts usage:

1. Please pay more attention to the installation position of the non-magnetic shield type coil when you design the printed circuit board to prevent malfunction caused by magnetic interference.
(在設計PCB時, 請考慮非磁屏蔽元器件的安裝位置, 避免磁干擾引起的故障.)

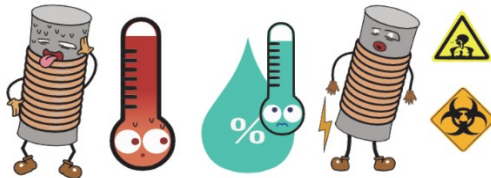
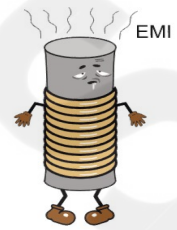

2. Product should not be exposed to environment with high temperature, high humidity, dust, corrosive gas and etc.
(請不要將產品保存在高溫、高濕、有灰塵、腐蝕性氣體等不適合環境中.)

3. The soldering conditions should also be observed. Temperature mentioned refers to the temperature of wave soldering for PIN or terminals but not the temperature of product itself.
(應留意焊錫條件, 說明中如有提及到焊錫溫度, 是指PIN或端子浸入波峰焊的溫度, 而不是指產品本體.)

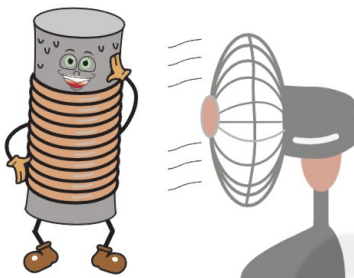
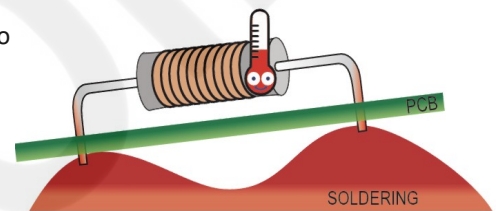

4. Please take the thermal design into consideration when choosing appropriate product, because the coil generates heat when electric current is applied.
(工作時電流通過繞組會產生一定的熱量, 在選用時請做散熱設計之考量.)

5. Please don't use products in a place with dewing. Please be careful when products is applied in a sealed condition since dewing would happen due to temperature change.
(請避免在結露的環境下使用, 在密閉環境中, 由於溫度的變化會導致結露, 使用時請注意.)

6. Please always handle products carefully to prevent any damage caused by dropping down or inappropriate removing.
(請小心輕拿輕放, 避免由於產品的跌落或取出不當而導致的損壞.)

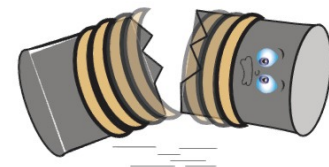

7. Don't touch electrodes directly with bare hands since oil secretions may do harm to solderability.
(手上有油脂可能導致可焊性下降. 請避免手直接接觸端子.)



8. Don't bend the terminals with excessive stress in case of any wire fracture.
(端子過度彎曲會導致斷線, 請不要過度彎曲端子.)

9. Please ensure that all terminals and case lugs are completely fixed onto PCB by soldering, and avoid placing coils near the edge of the PCB.
(請確保所有端子和膠殼足完全焊接到印刷電路板上, 盡量避免產品放在印刷電路板邊緣.)

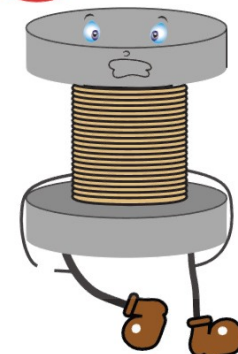

10. Don't rinse coils by yourself and please contact 3L if necessary.
(不要清洗產品, 如需要清洗時請聯繫我司.)

Please read cautions and warnings, important notes at the end of this document.

If you have any questions, please contact us. 如有任何問題請聯繫我司.



11. Since our SMD coils are designed for automatic mounting, please be careful when soldering manually. Please don't touch any exposed winding part and coil should not be used guiding by electrode in automatic mounting.
(由於表面貼裝件都是以自動安裝為基準設計,手動焊錫時請注意.產品自動安裝,請避免接觸卷線露出的部分.另外,不能將端子作為導向使用.)

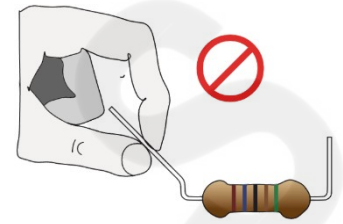

12. Our specification specifies the quality of the component as a single unit. Please ensure the component is thoroughly evaluated in your application circuit.
(本公司的規格書中只規定了產品的品質,在貴司使用中,請務必確認安裝在貴公司產品的狀態.)

13. When using our high voltage inverter transformers, please place it 2mm away from other electric conductor.
(對於產品高壓的逆變變壓器,在使用設計時要注意其他導體要離逆變器2mm以上.)

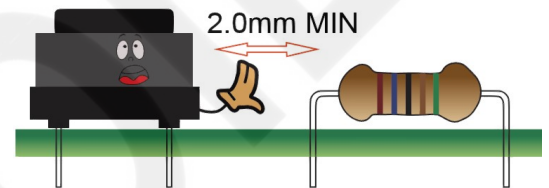

14. The following points must be paid attention to if the components are potted or glued to stick in customer applications:
(在客戶使用時,如果產品被灌封或膠固定,必須注意:)

- Many potting materials shrink as they harden. Therefore, they exert a pressure on the plastic housing or core, which may have a deleterious effect on electrical performance. In extreme cases, it would damage the mechanical performance of core or plastic housing.
(大部分灌封材料在硬化時都會收縮,因此對塑膠骨架或磁芯施加壓應力,這種應力作用可以給電氣特性帶來負面影響,極端情況下可能損壞磁芯或塑膠骨架的機械性能.)
- It is necessary to check whether the potting material used would lead to undesirable performance or break down of insulating layer of enameled wire, plastic bobbin or glue.
(必須檢查使用灌封材料是否會導致漆包線的絕緣層.塑膠骨架或膠水的性能降低甚至損壞.)
- The potting material can affect the high-frequency behavior of components.
(灌封材料的影響可以改變磁性元器件的高頻特性.)
- Ferrites are sensitive to direct shock, which might hurt or even break the core.
(鐵氧體對直接衝擊是很敏感的,衝擊可能導致磁性材料損傷甚至破碎.)
- For non-Alloy or non-coated molded inductors, its surface might become rusted if it was left in the humid environment. However, its electrical performance would not be affected.
(對於非合金或非塗層模壓產品,如果將產品長期放置在潮濕的環境中,產品的表面可能會生鏽,但不會影響產品的特性.)
- Even for customer-specific products, conclusive validation of the component in the circuit can only be carried out by customer.
(即使是客戶的特殊產品,決定性的驗證組件的電路也只能通過客戶執行.)

Please read cautions and warnings, important notes at the end of this document.

If you have any questions, please contact us. 如有任何問題請聯繫我司.



Note 1. The general testing condition is Temperature: 25 +/- 5°C (Room temperature) and humidity: 35-65% RH, which is applied to all products except specific product.

(注意 1. 除非特別指定,所有產品測試條件為:溫度: 25+/-5°C[室溫],濕度:35-65%RH.)

Note 2. For DIP type products, when the pin length is more than 5mm, the test position should be at 2-5mm away from the bottom of the product; For SMT type products, it is suggested to ensure better contact between the products and the tooling, as shown at right:

(注意 2. DIP 產品腳長超過 5mm 時, 測試位置應選取在產品底部 2-5mm 處; 對 SMT 產品, 產品的測試端子與夾具接觸良好. 如右圖:)

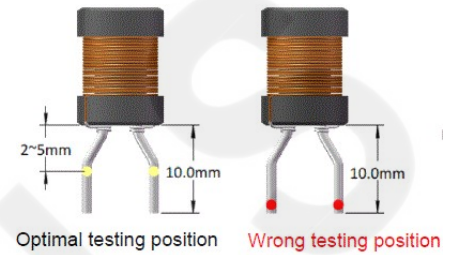

1. Inductance Test 電感測試

There could be measurement deviations with different instruments due to different test principles / internal resistance. Open and Short compensation should be performed before testing. Select the measurement fixture or testing wire that goes with the original instrument.

(不同儀器會因測試內阻及方法的不同而導致測試偏差,測量前需要進行歸零補償,測量時請選取儀器自帶的治具及測試線.)

2. Leakage Inductance Test 漏感測試

There could be measurement deviations with different instruments due to different test principles / internal resistance. Open and Short compensation should be performed before testing. Select the measurement fixture or testing wire that goes with the original instrument.

(不同儀器會因測試內阻及方法的不同而導致測試偏差,測量前需要進行歸零補償,測量時請選取儀器自帶的治具及測試線.)

3. DCR Test 直流電阻測試

Shorten the testing wire as much as possible to ensure better contact between the products and the tooling; there would be deviations for the DCR if the testing tooling contact surface is worn out or if the testing method is not correct, especially for low DCR products.

(盡量減短測試線的長度,保證產品與治具良好接觸,當測試夾具接觸面磨損或測量方法不正確時,會導致 DCR 值的偏差,特別是當 DCR 值較小時.)

4. Rated Current, Saturation Current, Temperature Rise Current 額定電流, 飽和電流, 溫升電流

The saturation current is according to the initial inductance drop amount; the rated current is generally taken by the smaller value between the saturation current and temperature rise current.

(飽和電流依初始電感下降變化量來選取;額定電流一般選取飽和電流和溫升電流兩者之間取較小值.)

5. Q Factor / SRF / Z Test 品質因數 / SRF / 阻抗測試

Shorten the pin length as much as possible to ensure better contact between the products and the tooling ;there can be deviation if the testing tooling contact surface is worn out or if the testing method is not correct.

(盡量減短引線的長度,保證產品與治具良好的接觸,當測試夾具接觸面磨損或測量方法不正確時,會導致測試值的偏差.)

6. Turns Ratio and Phase Test 圈比及相位測試

There would be deviations for turn counts ratio when there is magnetic leakage or air gap in the core center, please pay attention to the differences during testing. If the air gap is too large, then use the planar cores for confirmation; be careful to choose the foot position when testing the polarity.

(漏磁及產品耦合不良等原因會導致圈比測試偏差,請在測試中注意區分;當產品的氣隙過大時,請使用平面磁芯確認,相位測試注意腳位選取.)

7. Hi-Pot Test 高壓測試

Choose AC or DC accordingly during Hi-pot testing since they are different. If the humidity is too high or there is pollution on the surface, the Hi-pot test might fail. Please avoid testing in high humidity condition and keep the tooling and products clean. The Hi-pot test is destructive test and repeat testing should be avoided.

(AC 與 DC 的耐壓不同,請在測試時選擇相應的設置,濕度過高及表面受污染則可能會導致耐壓不良,請避免在高濕下測試并保持治具及測試產品乾淨.耐壓測試為破壞性測試,請避免重複測試.)

8. IWT Test 層間短路測試

Carefully choose the voltage and standard sample for the testing, IWT test is destructive testing and repeat testing should be avoided.

(注意電壓和標準樣品的選取,測試為破壞性測試,避免重複測試.)

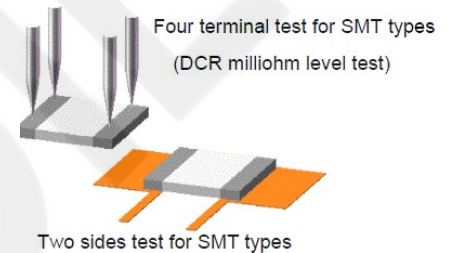

Please read cautions and warnings, important notes at the end of this document.

If you have any questions, please contact us. 如有任何問題請聯繫我司.

X-ON Electronics

Largest Supplier of Electrical and Electronic Components

Click to view similar products for [Common Mode Chokes / Filters](#) category:

Click to view products by [3L COILS](#) manufacturer:

Other Similar products are found below :

[74279408](#) [PE-62911NL](#) [PE-64683](#) [RD5122-6-9M6](#) [RGCMF1210900H3T](#) [ST6118T-R](#) [FE3X025-10-7NL](#) [T8114NLT](#) [RD5122-10-6M0](#)
[TCM0806G-350-2P-T](#) [TCM0806G-650-2P-T](#) [IND-0110](#) [UAL21VR0802000](#) [UALSC023000000](#) [UALSC1020JH000](#) [UALSC1520JH000](#)
[UALSU10VR15019](#) [UALSU9VD070100](#) [36-00037](#) [5701610000](#) [UALW21HS200290](#) [UALW21HS072450](#) [UALSU9HF050500](#)
[UALSU9H0208000](#) [UAL24VK06450CH](#) [PLT10HH501100PNB](#) [PLT10HH401100PNB](#) [PLT10HH1026R0PNB](#) [PE-67531](#) [TLH10UB 113](#)
[OR5](#) [2752045447](#) [CMS3-11-R](#) [7351V](#) [7408-RC](#) [CMF16-153131](#) [744252510](#) [T8116NLT](#) [CMS2-10-R](#) [DLW44SN101SK2L](#) [FE2X10-4-2NL](#)
[744253200](#) [744253101](#) [744252220](#) [TX8111NLT](#) [UAL30VR3500470](#) [CTX01-19077-R](#) [T8003NLT](#) [CTX01-13663](#) [CTX66-19521-R](#)
[7446630047](#)