

3M™ Locator Plate 3443-112

3M™ Platens 3442-44, 3442-9

Instructions for the assembly of 3M™ D Sub Connectors 8250 and 8350

1.0 General

3M manual and pneumatic assembly presses and accessory assembly equipment are recommended for the termination of 3M™ D Sub Connectors. 3M assembly equipment is offered to help reduce set-up time, to provide easier and faster assembly and to help reduce assembly error. The 3M Locator Plate 3443-112 and 3M Platen 3442-44 were designed to assemble the D Sub Connector 8250. The Locator Plate 3443-112 is used with the 3M™ Platen 3442-9 to assemble the D Sub Connector 8350.

Connector Part Number	Locator Plate Number	Platen Part Number	3436-1F Shut Height Setting		Assembly Press
			Assembly Presses 3640/3316	Assembly Presses 3335/3339-1	
8250	*3443-112	3442-44	15	15 1/2	3830
8350	*3443-112	3442-9	20	20 1/2	3830

*Included with the Locator Plate 3443-112 is a Platen 3442-44. The Platen 3442-44 can also be purchased separately.

2.0 Procedures for Set Up:

2.1 Adjust the shut height setting (see Figures 2 through 4).

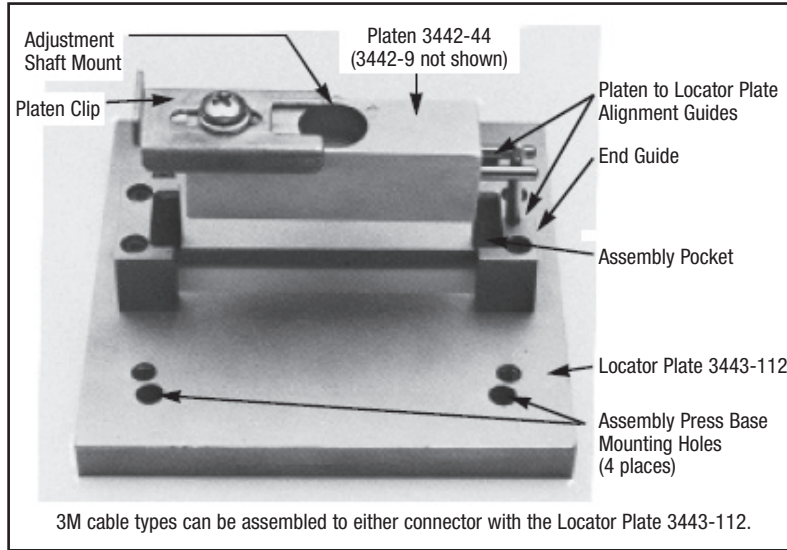

Figure 1: 3M™ Locator Plate 3443-112

3.0 Procedures for Adjusting Shut Height

3.1 The shut height should be adjusted from the base before the locator plate is put into place. The 3M™ Assembly Presses 3316 and 3640 are adjusted with a knob at the top of the press. The 3M™ Assembly Press 3335 is adjusted with the collar on the press shaft, and the 3M™ Assembly Press 3830 is self-adjusting.

3.2 The shut height adjustment is made from the base of the assembly press without the locator plate or platen in place.

3.3 Place the shut height gauge across the assembly press base. (See Figures 2 and 3)

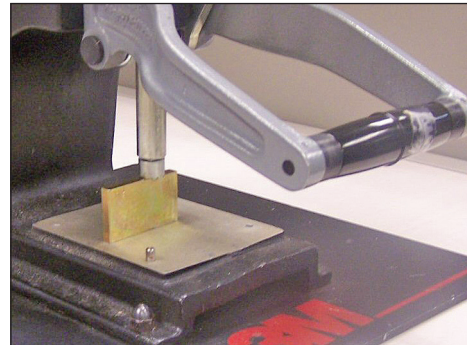

Figure 2: Shut Height Adjustment

3.4 Lower the handle of the assembly press until the handle casting makes contact with the press casting.

3.5 Rotate the shut height to lower or raise adjustment feature until the bottom of the shaft contacts the desired position on the shut height gauge. (See Figures 3 and 4)

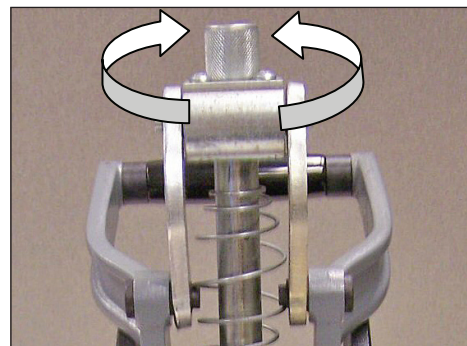

Figure 3: 3M™ Assembly Press 3640

- 3.6 Install the 3M™ Locator Plate and the appropriate platen on the assembly press. The platen should be positioned parallel with the connector body and cover.

Note: See the chart on page 1 for shut height settings.

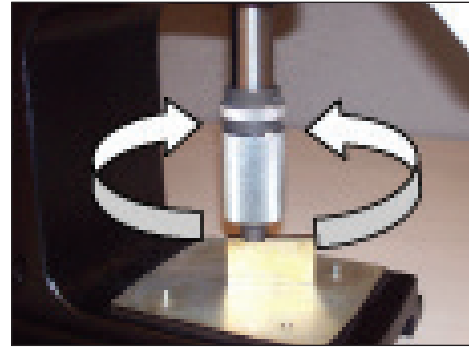

Figure 4: 3M™ Assembly Press 3335

4.0 Procedures for Adjusting Shut Height

- 4.1 Grasp a 3M™ D Sub Connector cover strip between the thumb and forefinger of both hands, with the liner facing you. Rotate the outermost cover down against the adjacent cover on the strip, breaking it from the liner. Pull laterally away from the strip. Adhesive should be present on cover. (See Figure 5)

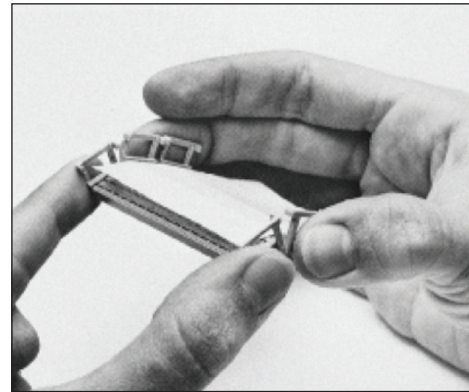

Figure 5

- 4.2 Firmly press the ribbed side of the cable into alignment grooves on cover. The adhesive will help the cable stay in place. Visually inspect to ensure that:
- Cable is properly aligned to cover grooves.
 - Cable end is flush with the cover for end terminations or perpendicular to cover for midspan terminations. (See Figure 6)

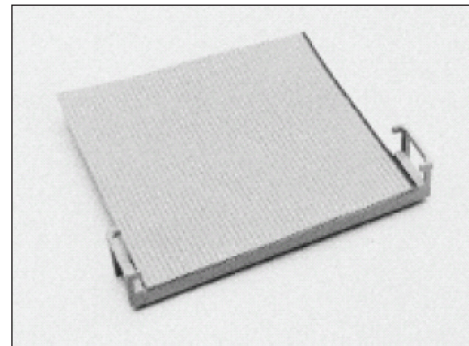

Figure 6

- 4.3 Place the cable/cover sub assembly between the guides on the locator plate, cover side down. (See Figure 7)
- 4.4 Position and orient connector body, contacts down, over the cable/cover sub-assembly, aligning with the body. (See Figure 7)

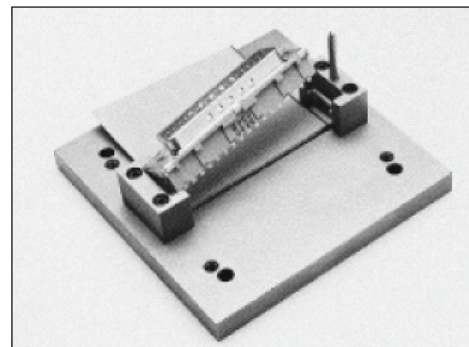

Figure 7

- 4.5 Lower the ASSEMBLY PRESS HANDLE firmly to complete the Cable/Connector Assembly. (See Figure 8.)
- 4.6 Raise the press handle and remove the completed assembly. Visually inspect to ensure that:
 - a. Cover is fully seated and parallel with the body.
 - b. Cable is properly aligned with the cover grooves.
 - c. Cover retaining devices on the body are flush with the cover end.



Figure 8

Customer and Technical Service

Within the U.S.:

Customer Service: 800-225-5373

Technical Support: 512-984-6703

Outside of the U.S.:

For customer service and technical support, please contact your local 3M Electronic Solutions Division representative.

3M is a trademark of 3M Company.

Important Notice

PRODUCT USE: All statements, technical information and recommendations contained in this document are based upon tests or experience that 3M believes are reliable. However, many factors beyond 3M's control can affect the use and performance of a 3M product in a particular application, including the conditions under which the product is used and the time and environmental conditions in which the product is expected to perform. Since these factors are uniquely within the user's knowledge and control, it is essential that the user evaluate the 3M product to determine whether it is fit for a particular purpose and suitable for the user's application.

Warranty; Limited Remedy; Limited Liability.

3M's product warranty is stated in its Product Literature available upon request. **3M MAKES NO OTHER WARRANTIES INCLUDING, BUT NOT LIMITED TO, ANY IMPLIED WARRANTY OF MERCHANTABILITY OR FITNESS FOR A PARTICULAR PURPOSE.** If this product is defective within the warranty period stated above, your exclusive remedy shall be, at 3M's option, to replace or repair the 3M product or refund the purchase price of the 3M product. **Except where prohibited by law, 3M will not be liable for any indirect, special, incidental or consequential loss or damage arising from this 3M product, regardless of the legal theory asserted.**



Electronic Solutions Division
Interconnect Products

6801 River Place Blvd.
Austin, TX 78726-9000
800-225-5373
www.3Mconnector.com

Please recycle. Printed in USA.
© 3M 2013
78-9101-0518-4-B

X-ON Electronics

Largest Supplier of Electrical and Electronic Components

Click to view similar products for [Headers & Wire Housings](#) category:

Click to view products by [3M](#) manufacturer:

Other Similar products are found below :

[892-18-020-10-001101](#) [58102-G61-06LF](#) [582553-1](#) [0009485154](#) [009176003701906](#) [0050291907](#) [LY20-4P-DT1-P1E-BR](#) [02.125.8002.8](#)
[609-3404](#) [61062-3](#) [622-0430](#) [622-3653LF](#) [63453-116](#) [636-1030](#) [636-1427](#) [636-3427](#) [636-4007](#) [641938-9](#) [641991-4](#) [644827-2](#) [65817-010LF](#)
[65817-015LF](#) [65863-015LF](#) [66207-023LF](#) [67095-007LF](#) [67601157](#) [68648-049](#) [70.362.1628.0](#) [70-4210](#) [70-4226B](#) [70-4853B](#) [707-5020](#) [707-5028](#) [71.350.2428.0](#) [71918-208LF](#) [71961-016LF](#) [733-134](#) [733-162](#) [754199-000](#) [760-3052](#) [787-8014-00](#) [79531-3000](#) [FCN-360C032-B](#) [FCN-367T-T012/H](#) [FCN-723D010/2](#) [80.063.4001.1](#) [800-90-001-10-001000](#) [800-90-010-10-002000](#) [801-43-002-10-013000](#) [801-43-006-10-002000](#)