

**3M**

Fibrlok™ II 2529  
Universal Optical Fiber Splice

Instructions

## Contents:

1.0	General .....	3
2.0	Splicing Set-up .....	4
3.0	Fiber Preparation .....	5
4.0	Splice Assembly .....	6
5.0	Fiber Repositioning .....	8
6.0	Fiber Organization and Splice Storage .....	9
7.0	Splicing Accessories .....	11

# 1.0 General

1.01 The 3M brand Fibrlok™ II 2529 Universal Optical Fiber Splice provides permanent mechanical splices for single- or multimode fiber having 125 μm diameter cladding. The Fibrlok™ II 2529 Universal Splice is designed to accommodate any combination of fibers with coating diameters from 250 μm to 900 μm.

1.02 All Fibrlok™ II 2529 Universal Optical Fiber Splices are gray in color and are marked with the 3M Fibrlok™ II logo on the splice cap.

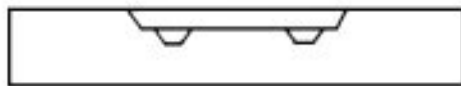
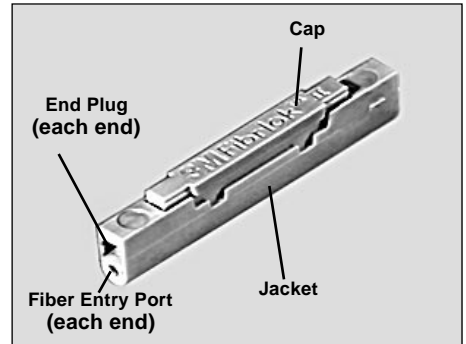
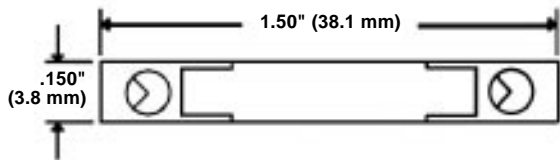

## 1.03 Fibrlok™ 2501 Assembly Tool

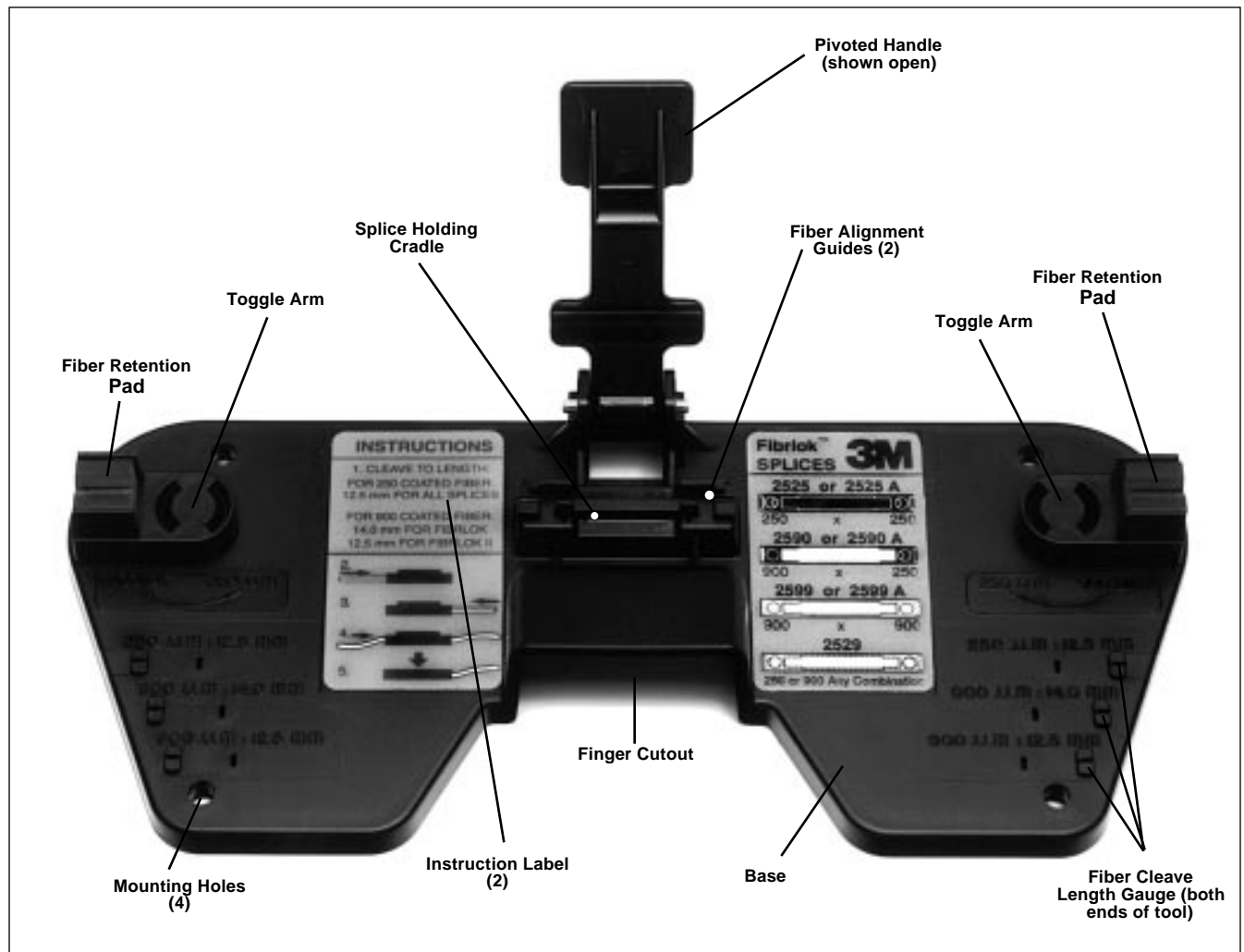

1.04 **Tools and Materials Required are as follows:**

- Fibrlok™ 2500 or 2501 Assembly Tool
- Plastic Coating (Buffer) Stripper
- Reagent Grade Isopropyl Alcohol
- Lint-free Wipes
- Cleaver
- Fibrlok 2505 Assembly Tool Mounting Adaptor (optional)
- Fibrlok™ II Video Instruction Tape (optional)
- Tool Kit (optional)

1.05 **Some Compatible Organizers are:**

- 3M 2118, 3M 2524, 3M 2672
- AT&T UC-SS/M1
- GTE Part 910470 0000, 910470 1000
- Siecor M67-070
- Keptel LightLink

Others compatible with minor modifications:

- DiTel UST 3000, UST 3010, UST 3500
- AT&T 846 280 626, 846 280 634, 846 280 642, 846 280 659
- Raychem FOSSC 100/TK

## 2.0 Splicing Set-Up

2.01 The splicing area should be clean, dry and well-lighted. A clean, well-organized splicing area will improve splice efficiency and minimize the risk of contamination of fibers or splices.

2.02 Open the buffer tubes, expose and clean the fibers per your company practice.

**Note:** *Storage, use and disposal of isopropyl alcohol should be per your company health, safety and environmental instructions. Refer to solvent label or Material Safety Data Sheet.*

2.03 See Section 6.0 for recommended procedures for fiber organization and splice storage.

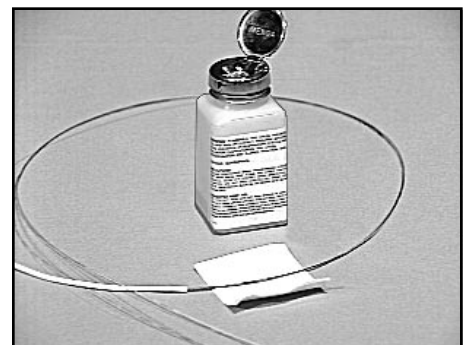
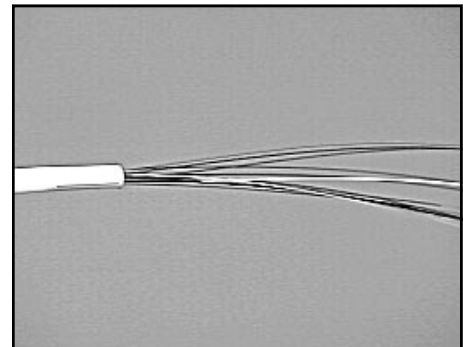

2.04 Remove Fibrlok splice from protective package. Load the splice into the assembly tool by pressing firmly at the **ends** of the splice.

**Note:** *Carefully follow health, safety and environmental information on Fibrlok II Splice label or Material Safety Data Sheet.*

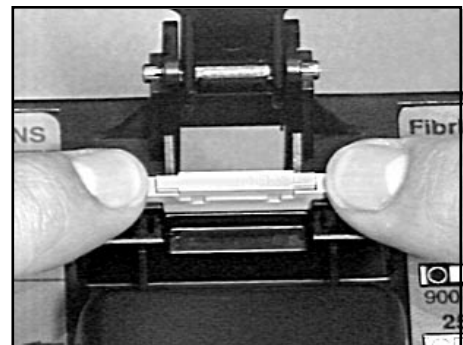

- 2.05 If using the Fibrlok 2501 Assembly Tool, rotate the toggle arms for the appropriate fiber size.

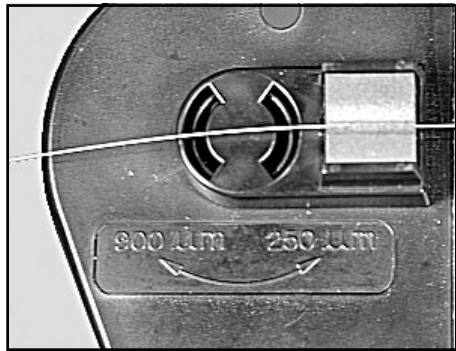

Inward – 250 m

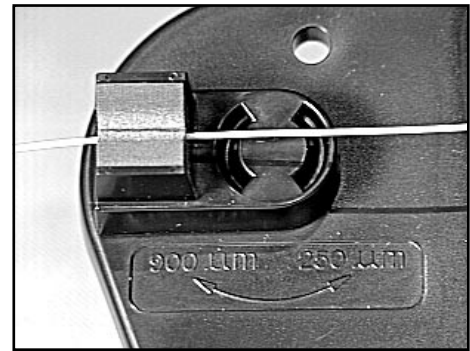

Outward – 900 m

### 3.0 Fiber Preparation

- 3.01 Remove the minimum length of fiber required to prepare and splice the fibers.
- 3.02 Strip approximately 1 to 2 inches (25 mm to 51 mm) of plastic coating from the fiber using a mechanical stripper.

**Note:** *The stripper should be in good operating condition to prevent scratches or other damage to the glass cladding.*

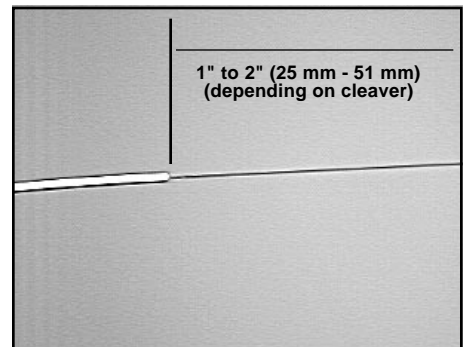

- 3.03 Clean the bare glass by pulling the fiber through an alcohol soaked lint-free wipe. This will remove any fragments or dirt remaining on the fiber.

**Note:** *Do not wipe the fibers more than two times, and limit the time that the bare fiber is exposed to the atmosphere.*

**Note:** *Carefully follow health, safety and environmental information on container label or Material Data Sheet for isopropyl alcohol being used.*

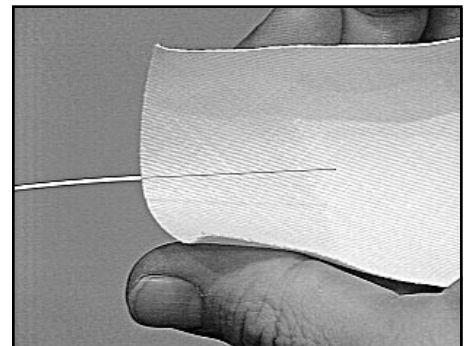

- 3.04 Cleave fiber to 12.5 mm  $\pm$ 0.5 mm (0.492  $\pm$ 0.020 inches).

**Important:** *The Fibrlok™ II 2529 Universal Splice uses a cleave length of 12.5 mm  $\pm$ 0.5 mm (0.492  $\pm$ 0.020 inches) for both 250 m and 900 m coated fibers.*

**Note:** *The cleaver should be in good operating condition and used in accordance with the manufacturer's instructions. It is recommended that the cleaver provide a consistent cleave-to-coating length within  $\pm$ 0.5 mm. In addition, standard cleavers should produce cleaved ends within  $\pm$ 2° of perpendicular and free of major defects. Cleavers specifically designed to produce controlled, angled cleaves of greater than  $\pm$ 2° may also be used with the Fibrlok™ II Optical Splice.*

3.05 Check the cleave length using the 12.5 mm cleave length gauges on the Fibrlok Assembly Tool. Adjust the cleaver to provide the prescribed cleave lengths. Check cleave lengths periodically during subsequent splicing operations.

**Note:** *Do not allow cleaved end to contact tool. Do not clean the fibers again after they have been cleaved.*

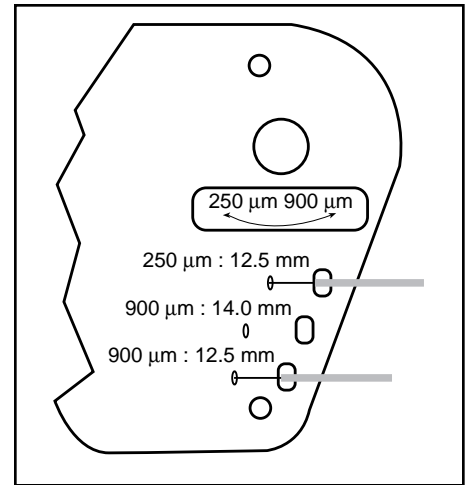

## 4.0 Splice Assembly

4.01 Push the fiber down into the fiber retention pad on the proper side of the splice.

**Note:** *Hold the coated portion of the fiber ONLY. Do not allow the cleaved end to contact any surface before insertion into the splice.*

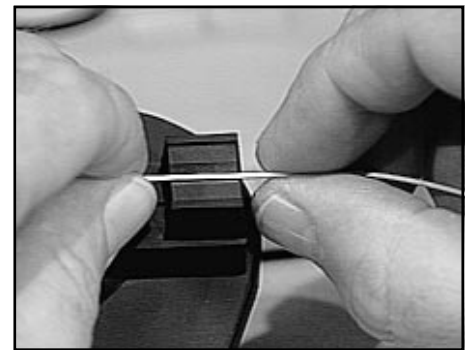

4.02 Grasp the coated fiber about .25 inches (6 mm) from the bare glass and move the fiber end onto the fiber alignment guide on the assembly tool such that the end is resting on the alignment guide outside of the splice.

**Note:** *When splicing 250 μm to 900 μm coated fiber, always insert the 250 μm coated fiber first.*

**Note:** *Fiber should be placed in the retention pad and inserted into the splice immediately following cleaning to minimize exposure to the atmosphere and reduce the risk of contamination.*

**Note:** *Push fiber straight into fiber alignment guide, NOT AT AN ANGLE.*

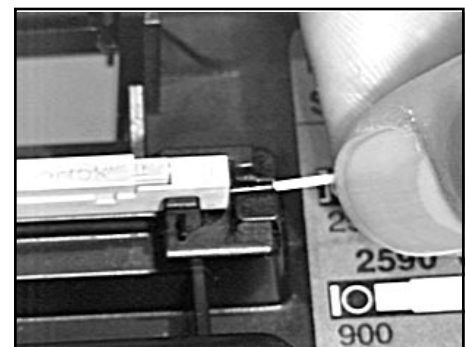
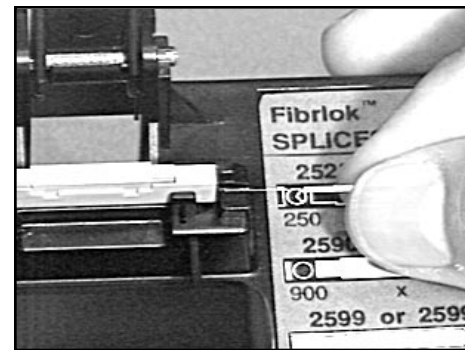

- 4.03 Gently continue pushing the fiber into the splice until resistance is felt. When fully inserted, the first fiber should be straight or have a slight bow – up to .1 inch (3 mm).

**Note:** *If properly inserted, bare glass should not be visible outside of splice. If bare glass is visible, pull back slightly on fiber and continue insertion until resistance is met. Never fully remove fibers from splice after initial insertion. Do not pull on fiber after it has been properly inserted.*

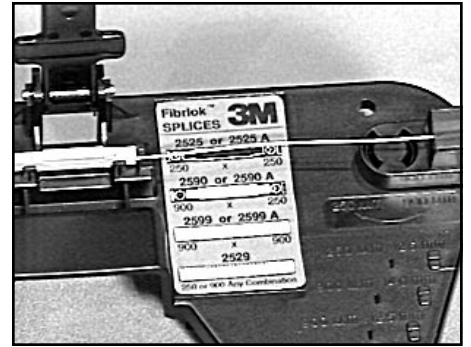

- 4.04 Prepare second fiber (strip, clean and cleave) as described in Section 3.

- 4.05 Lay fiber into foam retention pad and begin to insert the fiber end into the splice, as in 4.01 and 4.02.

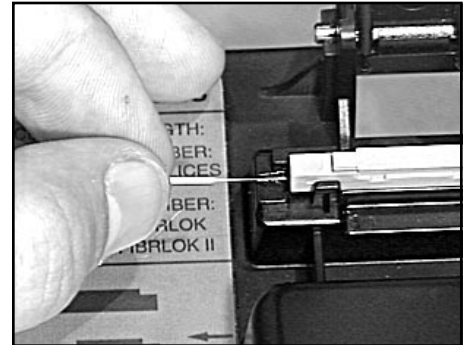

- 4.06 Gently push the second fiber in small increments straight through the alignment guide into the fiber entry port. As the coating of the second fiber enters the fiber entry port, watch for the bow in the first fiber to increase. This occurs when the end face of the second fiber contacts the first fiber and pushes the first fiber slightly back out of the splice. Continue gently pushing the second fiber until it meets resistance.



- 4.07 Following proper insertion, the second fiber will be approximately straight, but may have up to a .1 inch (3 mm) maximum bow. At this point, the first fiber will have a larger bow than the second fiber and **larger** than it had initially.

- 4.08 Push the first fiber back against the second fiber until there are equal bows in both fibers.

**Note:** *Do not pull on either of the fibers following establishment of the bows in the first and second fibers. The fiber ends must be held together by the compressive forces induced by the bows to produce a low loss splice.*

*If fiber bows are NOT observed to move as described, repeat steps 4.02 – 4.07 of Splice Assembly but DO NOT fully remove fibers from the splice. If bow movement is still not observed, remove fibers, strip, clean and re-cleave, checking for proper cleave length. Re-splice per splicing procedure using a new splice.*

*Do not attempt to "tune" or optimize the splice as this may result in higher splice loss. The Fibrlök™ II Splice is not designed to be "tuned." Fiber alignment does not occur until the splice is activated.*



- 4.09 Pivot the handle of the Fibrlok Assembly Tool down until it contacts the cap of the Fibrlok Splice. **Squeeze the handle of the assembly tool as shown in order to close cap and actuate the splice. When possible, secure the tool to a work surface for added support.** A snap sound will be heard when the splice is actuated.

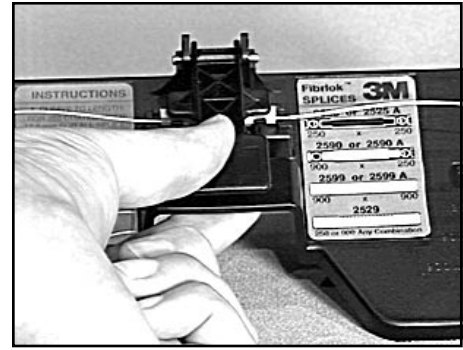

- 4.10 Remove the Fibrlok Splice from the assembly tool by first removing the fibers from the foam retention pads and then lifting the splice from the splice holding cradle.

**Note:** *In the event a splice must be refabricated, simply cut the fibers at each end of the splice (this will remove 1-1/2" of fiber from the loop) and re-splice per instructions. Splice fabrication will require a new splice and a length of 2 inches on each fiber.*

**DO NOT REMOVE FIBERS AND RE-USE FIBRLOK SPLICES.**

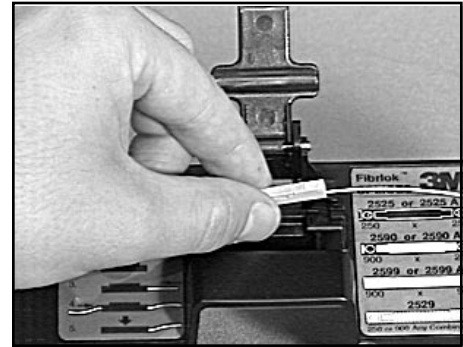

## 5.0 Fiber Repositioning

- 5.01 If high loss is observed after splice has been actuated, it is possible that the fiber ends are separated. In this case, lift the splice cap and reposition fiber ends, as instructed below.

**NOTE:** **DO NOT COMPLETELY REMOVE FIBERS FROM FIBRLOK SPLICES.**

- 5.02 While the splice is in the splice holding cradle, insert the short prongs of the Fibrlok II Splice Cap Lifter into the two holes on the side of the splice. The cap lifter will be at an angle to the splice. The long prongs will be resting against the top of the splice cap.

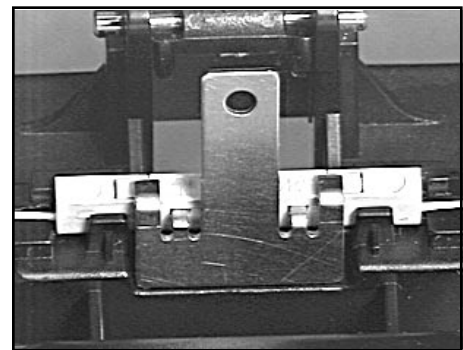

- 5.03 Slide the bottom of the cap lifter inward until it is in a vertical position, lifting the splice slightly out of the cradle.

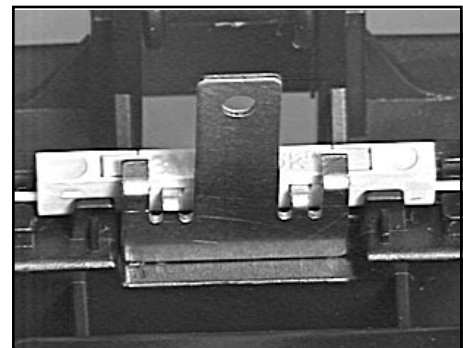



- 5.04 Hold the cap lifter in place with one hand and push down on the ends of the splice with the other hand. This action should reseat the splice into the holding cradle and lift the cap at the same time.
- 5.05 Repeat fiber centering and splice actuation (See step 4.06 – 4.09.) If after two attempts an acceptable splice loss is not obtained, remove fiber, strip, clean and re-cleave. Re-splice using a new splice.

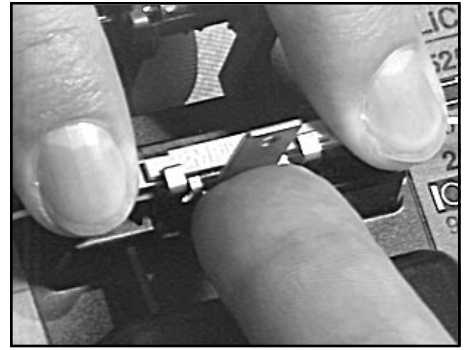

## 6.0 Fiber Organization and Splice Storage

- 6.01 When storing fiber slack in a splice tray, the spliced fiber ends will twist one full turn for each full loop of fiber being stored. This rotation places stress on the fibers. This rotational stress makes fiber organization more difficult and may affect fiber/splice performance, particularly in 900  $\mu$ m coated fibers. The stiffness of the 900  $\mu$ m fiber does not distribute this stress in the same manner as 250  $\mu$ m coated fiber. The following procedure is strongly recommended when splicing 900  $\mu$ m coated fibers and will improve fiber organization when splicing **all** fiber types.
- 6.02 Secure the buffer tubes of the fibers to be spliced to the tray so that the fibers are free to rotate through the point of attachment.
- 6.03 Select the first two fibers to be spliced and lay them into the tray. Trim the fibers so they are the right length for splicing plus approximately 1 to 2 inches (2.5 to 5 cm) for fiber end preparation.

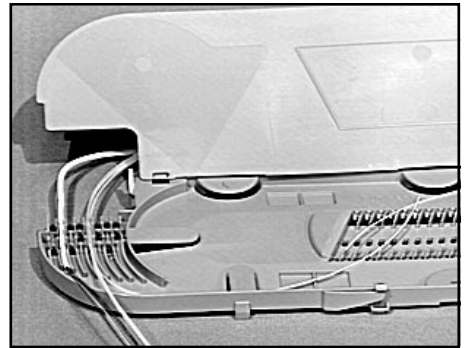

- 6.04 Place the splice assembly tool close to or on top of the splice tray. Match the orientation of the tool to that of the splice holder or tray whenever possible.

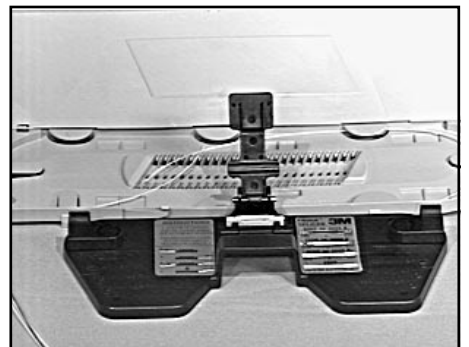

6.05 Remove the minimum amount of fiber required for fiber preparation and splicing. Remove less than one loop if possible.

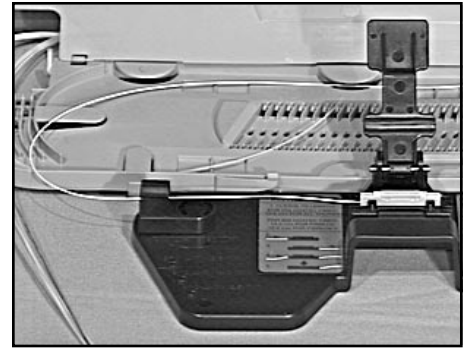

6.06 Prepare fibers and complete splice as described in Section 3 and 4.

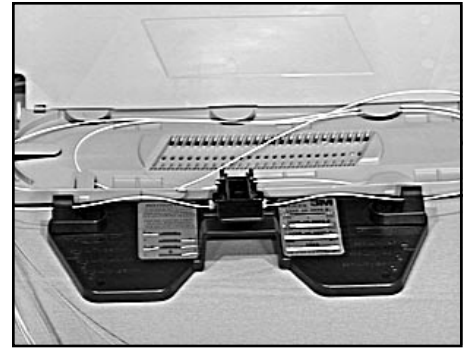

6.07 Carefully lay the splice on top of the holder without securing the splice into the holder.

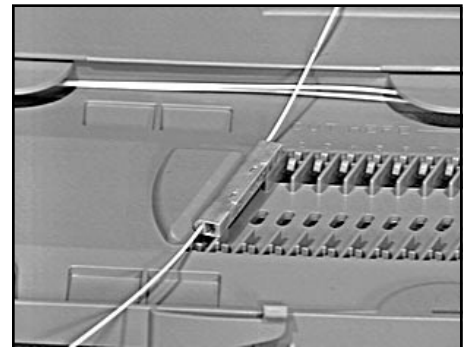

6.08 For 250 to 250 m and 900 to 900 m splices:  
a. Store the shorter of the two fibers in the tray.  
b. Observe how the splice lays in its relaxed state. Rotate the splice through the smallest possible angle to install it in the tray.  
c. Store the second fiber.

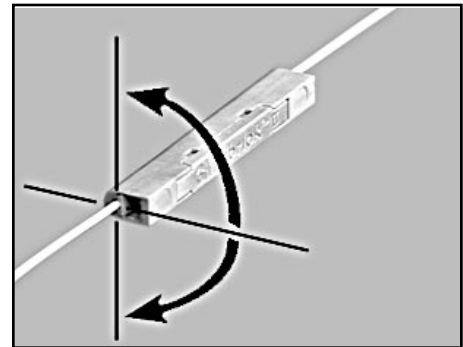

6.09 For 250 to 900 m splices:  
a. Store the 900 m fiber first.  
b. Grasping the splice by the 900 m fiber, observe how the splice lays in its relaxed state. Rotate the splice through the smallest possible angle to install it in the tray.  
c. Store the 250 m fiber.

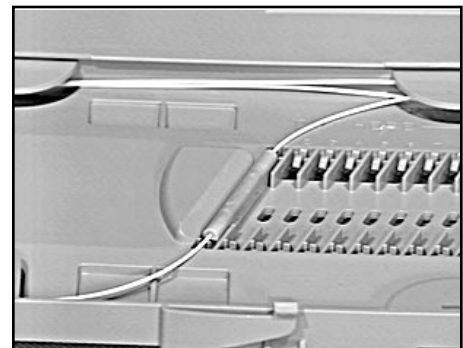

## 7.0 Splicing Accessories

7.01 The 3M Fibrlok™ 2524 Splice Organizer Tray holds up to 24 Fibrlok Splices and provides superior fiber and splice organization. Easily installed, the tray will accommodate up to eight buffer tubes holding up to 48 fibers (250 μm or 900 μm coated fibers) and can be adapted for fusion splice storage.

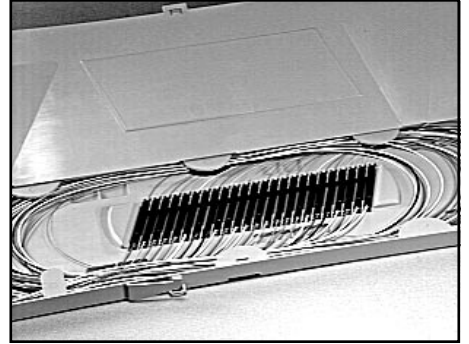

7.02 The 2524 Splice Tray fits and mounts into the 3M 2177 Fiber Optic Splice Closure, the 3M 2178 Fiber Optic Splice Case and the 3M 2190 PST Fiber Optic Splice Closure. It is also compatible with a variety of non-3M closures.

7.03 The 3M Fibrlok™ 2505 Assembly Tool Mounting Adapter permits mounting of the Fibrlok Assembly Tool on standard 3M MS<sup>2</sup>™ Splicing Rigs, conventional camera-type tripods, and other standard telco splicing rig components. The 2505 Mounting Adapter provides the ability to mount the Fibrlok Assembly Tool on a variety of surfaces, and in any orientation, for splicing in difficult locations such as manholes, aerial splice points, pedestals and distribution frames.

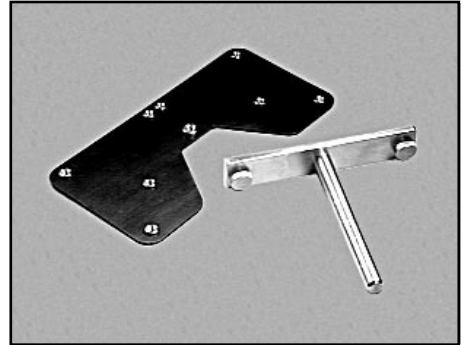

7.04 3M Fiber Preparation Kits provide all the tools necessary for the assembly of the Fibrlok Splice. Fiber Splice Preparation Kits are available in a variety of combinations with or without the Fibrlok Assembly Tool and/or cleaving tool.



### Fiber Splice Preparation Kits:

### 3M Stock Number

#2530 Kit with all components listed below and Thomas & Betts Cleave Tool .....	80-6104-5390-6
#2531 Kit with all components listed below .....	80-6104-5317-9
#2533 Kit with all components listed below excluding Fibrlok Assembly Tool .....	80-6104-5319-5

### Splice Kits Components Listing (available separately)

Fibrlok 2501 Assembly Tool .....	80-6105-8187-0
Cable Strippers .....	80-6104-4314-7
Cleaning Alcohol Bottle .....	80-6104-4329-5
Scissors .....	80-6104-4754-4
No-Nik Stripper (.008) .....	80-6104-4808-8
Micro Stripper (.006) .....	80-6105-7250-7
Lint Free Cloth (100/pkg.) .....	80-6104-4324-6
Magnifier, Cleaved Fiber Inspection .....	80-6104-4799-9
Coaxial Cable Stripper .....	78-8073-7415-8
Instruction Manual .....	78-6900-1905-0

**Important Notice**

All statements, technical information and recommendations related to the Seller's products are based on information believed to be reliable, but the accuracy or completeness thereof is not guaranteed. Before utilizing the product, the user should determine the suitability of the product for its intended use. The user assumes all risks and liability whatsoever in connection with such use.

Any statements or recommendations of the Seller which are not contained in the Seller's current publications shall have no force or effect unless contained in an agreement signed by an authorized officer of the Seller. The statements contained herein are made in lieu of all warranties, express or implied, including but not limited to the implied warranties of merchantability and fitness for a particular purpose which warranties are hereby expressly disclaimed.

SELLER SHALL NOT BE LIABLE TO THE USER OR ANY OTHER PERSON UNDER ANY LEGAL THEORY, INCLUDING BUT NOT LIMITED TO NEGLIGENCE OR STRICT LIABILITY, FOR ANY INJURY OR FOR ANY DIRECT OR CONSEQUENTIAL DAMAGES SUSTAINED OR INCURRED BY REASON OF THE USE OF ANY OF THE SELLER'S PRODUCTS THAT WERE DEFECTIVE.



**Telecom Systems Division**

6801 River Place Blvd.  
Austin, TX 78726-9000  
800/426-8688

## X-ON Electronics

Largest Supplier of Electrical and Electronic Components

*Click to view similar products for [Fibre Optic Connectors](#) category:*

*Click to view products by [3M](#) manufacturer:*

Other Similar products are found below :

[0004700001](#) [6100-R](#) [6313](#) [F709034706](#) [F709722200](#) [F709730000](#) [F718183204](#) [F727403500](#) [F727752800](#) [8119](#) [9440F20-27S-190](#) [944-120-6001](#) [9441F10SL-3S](#) [9444W28-21S](#) [9444W36-10S](#) [9446F10SL-4S](#) [9446W20-16S](#) [953-101-5310-P](#) [954-101-57202B](#) [A0270169](#) [12-9122](#) [12-5702](#) [AX101713](#) [AX102420](#) [AX103923](#) [AX104024](#) [AX104193](#) [AX104230](#) [AX104498](#) [AX104562](#) [AX105203-B25](#) [AX105205-S1](#) [EHSC2M](#) [181-011-126](#) [181-011-S](#) [181-057-126](#) [HRFC-R2\(40\)](#) [NKSOPBUY](#) [20500002116](#) [2064996-1](#) [20800001065](#) [2170](#) [9132](#) [2612](#) [2620](#) [9291](#) [9440F16-10S](#) [9440F20-18S](#) [9442W14S-10P](#) [9446F16-10S-190](#)