

3M™ Card Connector microSD™

Normal Polarization, Push-Push, Surfacemount

2900 Series

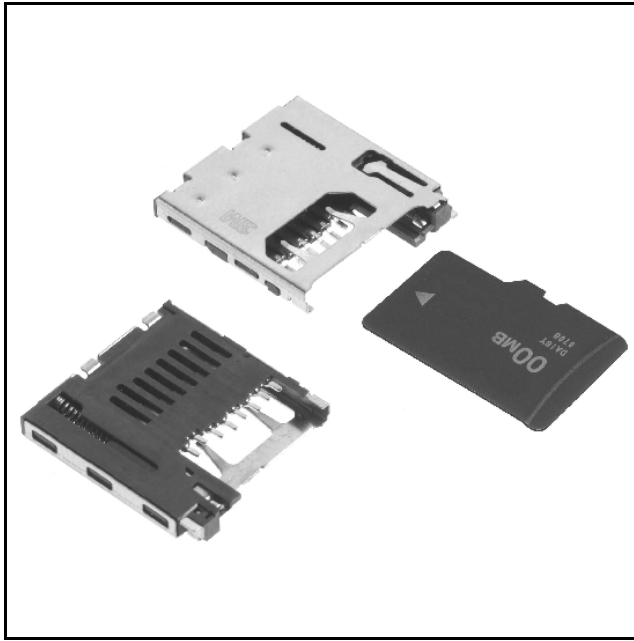

- 1.85 mm low profile height
- Small size of 14.0 mm × 14.2 mm footprint
- Smooth push-push eject mechanism
- Card is retained when mated
- Card polarization
- Will accept a card thickness of 0.8 mm
- Mechanism prevents card from flying out upon ejection
- Card detection indicator
- Metal-shielded cover
- microSD™ specification compliant
- RoHS* compliant

Date Modified: October 31, 2006

TS-2197-02
Sheet 1 of 3

Physical

Insulation Material: High Temperature Thermoplastic

Flammability: UL 94V-0

Color: Black

Contact Material: Copper Alloy

Plating

Underplating: 50 μ" [1.27 μm] min. Nickel

Wiping Area: 15 μ" [0.38 μm] min. Gold

Termination Area: 3 μ" [0.076 μm] max. Gold flash

Cover Material: Stainless Steel

Underplating: 40 μ" [1.02 μm] min. Nickel

Solder Area: Gold flash

Lock Pin and Link Pin Material: Stainless Steel

Spring Material: Copper Alloy

Plating: 30 μ" [0.762 μm] min. Nickel

Marking: 3M Logo

Electrical

Current Rating: 0.5 A

Insulation Resistance: 100 MΩ min.

Withstanding Voltage: 500 VAC for one minute

Environmental

Operating Temperature: -25°C to +85°C

Storage Temperature: -40°C to +85°C

Process Rating: Maximum 250°C, with 40 seconds over 230°C

RoHS compliant means that the product or part does not contain any of the following substances in excess of the following maximum concentration values in any homogeneous material, unless the substance is in an application that is exempt under RoHS: (a) 0.1% (by weight) for lead, mercury, hexavalent chromium, polybrominated biphenyls or polybrominated diphenyl ethers; or (b) 0.01% (by weight) for cadmium. Unless otherwise stated by 3M in writing, this information represents 3M's knowledge and belief based upon information provided by third party suppliers to 3M.

microSD is a trademark of SD Association in Japan.

3M™ Card Connector microSD™

Normal Polarization, Push-Push, Surfacemount

2900 Series

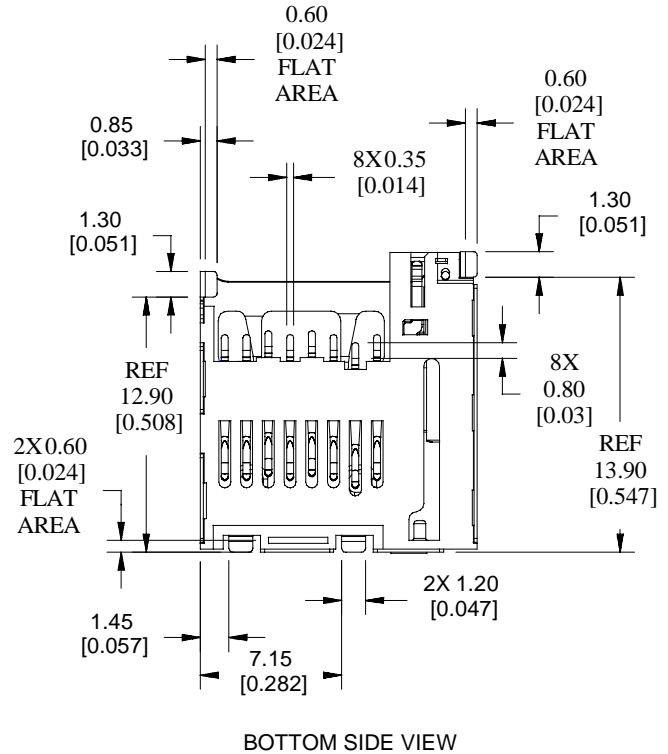
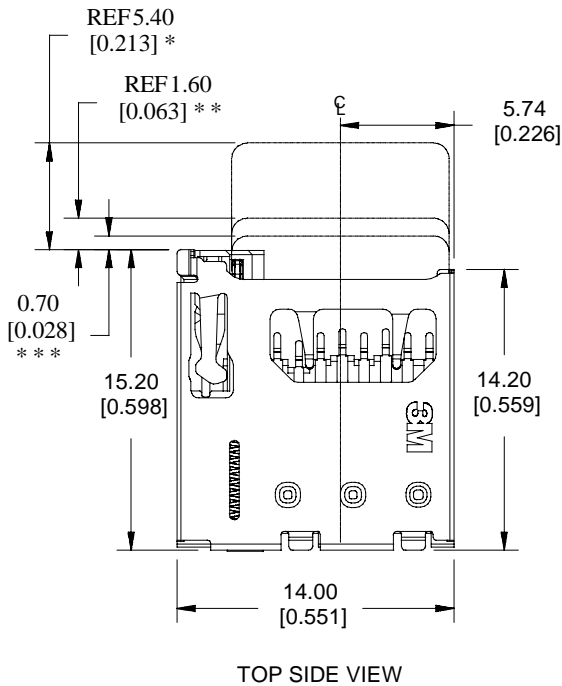
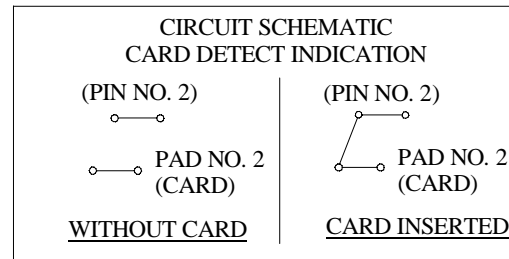
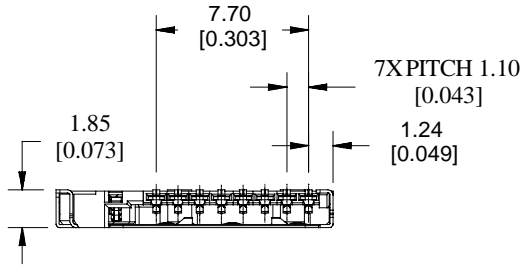

Notes:

- * Card fully ejected position
- ** Card in locked position
- *** Card fully pushed in

mm
[Inch]

Tolerance Unless Noted			
	.0	.00	.000
mm	±.25	±.15	±.05

[] Dimensions for Reference Only

3M™ Card Connector microSD™

Normal Polarization, Push-Push, Surfacemount

2900 Series

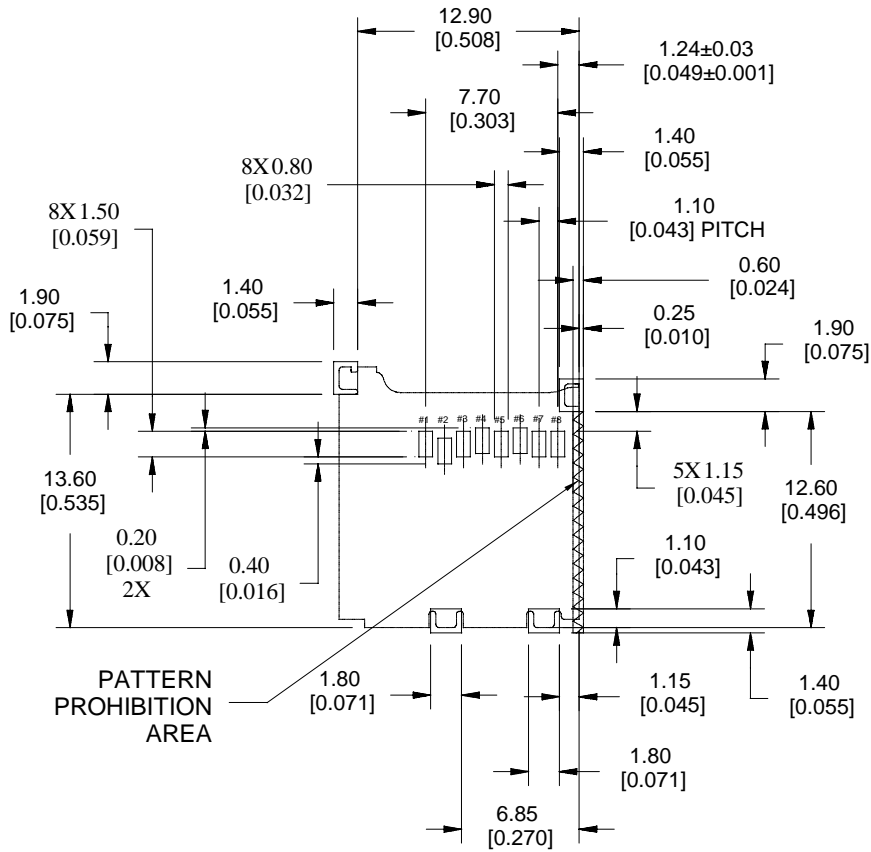

RECOMMENDED
PCB PATTERN LAYOUT ± 0.05 [0.002]

Ordering Information

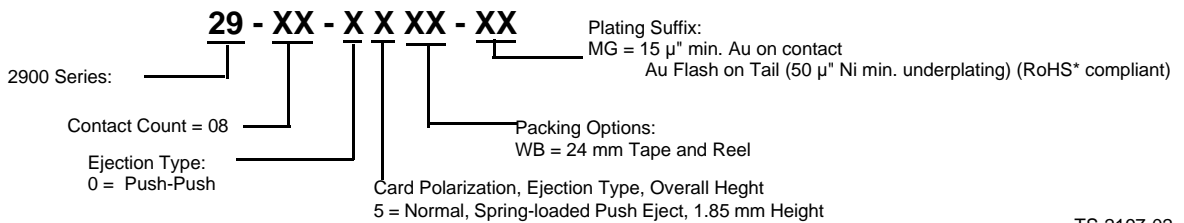

TS-2197-02
Sheet 3 of 3

Important Notice

All statements, technical information, and recommendations related to 3M's products are based on information believed to be reliable, but the accuracy or completeness is not guaranteed. Before using this product, you must evaluate it and determine if it is suitable for your intended application. You assume all risks and liability associated with such use. Any statements related to the product which are not contained in 3M's current publications, or any contrary statements contained on your purchase order shall have no force or effect unless expressly agreed upon, in writing, by an authorized officer of 3M.



3M Electronics

6801 River Place Blvd.
Austin, TX 78726-9000
800/225-5373
www.3M.com/electronics

Warranty; Limited Remedy; Limited Liability.

This product will be free from defects in material and manufacture for a period of one (1) year from the time of purchase. **3M MAKES NO OTHER WARRANTIES INCLUDING, BUT NOT LIMITED TO, ANY IMPLIED WARRANTY OF MERCHANTABILITY OR FITNESS FOR A PARTICULAR PURPOSE.** If this product is defective within the warranty period stated above, your exclusive remedy shall be, at 3M's option, to replace or repair the 3M product or refund the purchase price of the 3M product. **Except where prohibited by law, 3M will not be liable for any indirect, special, incidental or consequential loss or damage arising from this 3M product, regardless of the legal theory asserted.**



Minimum 10%
Post-Consumer Fiber

Printed in USA.

© 3M 2006

X-ON Electronics

Largest Supplier of Electrical and Electronic Components

Click to view similar products for [Memory Card Connectors](#) category:

Click to view products by [3M](#) manufacturer:

Other Similar products are found below :

[M21-033321-005](#) [6407-249V-25273P](#) [6407-249V-25343P](#) [6426-201-21343](#) [69.920.0553.0](#) [FCN-568P068-G/07-4V](#) [809180410000000](#)
[N7E50-7516PG-20-WF](#) [21920-5](#) [2041353-2](#) [33CFAE-DN](#) [502431-1011](#) [EN2997S61212BN](#) [EN2997SE61212BN](#) [95622-003LF](#) [N7E50-](#)
[U516RB-50-SIN0005](#) [95079-00CALF](#) [84648-056HLF](#) [68-580163-21S](#) [33DVIR-29S12R](#) [125A-78C00](#) [MI20A-50PD-SF-EJL\(71\)](#) [KP10S-SF-](#)
[PEJ\(812\)](#) [504536-0691](#) [504580-0691](#) [CCM03-3109 B LFT](#) [2309923-1](#) [61126-050CAHLF](#) [G85DT17001P1EU](#) [G85B21611142HHR](#)
[GSD090144HR](#) [G85D1140022P1HR](#) [GMCB05801124EU](#) [115S-BS00](#) [503960-0695](#) [101B-TAA0-R](#) [101D-TAAA-R01](#) [101D-TAAB-R01](#)
[104D-TCA0-R06](#) [104B-TAA0-R](#) [112C-TBAR-R02](#) [114B-40B00-R02](#) [112G-TA00-R](#) [112J-TDAR-R01](#) [115C-AC00-R](#) [115D-AAA0-RA1](#)
[115E-AEB0-R01](#) [115A-ADA0-R02](#) [115E-AEA0-R01](#) [115G-AAAA-R](#)