

# Cables and Accessories Selection Guide

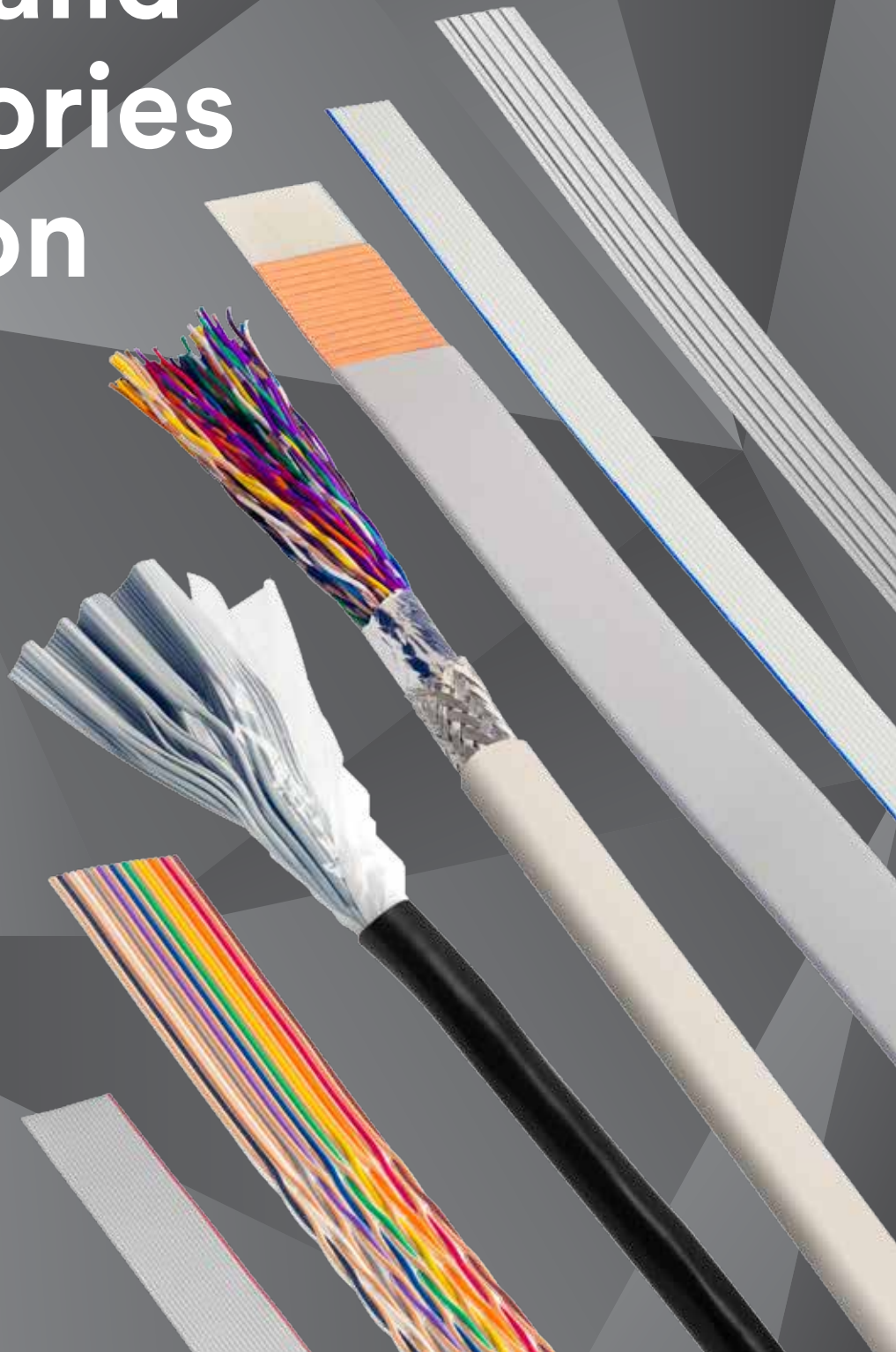

**From data centers to robotics to patient monitoring equipment, we're committed to enabling the next generation of faster, smaller and smarter design. 3M offers an extensive portfolio of cables and accessories built for speed and reliability, so you get the performance you need with as little downtime possible. Visit [3Mconnectors.com](http://3Mconnectors.com) for tech sheets and more information.**

# Table of Contents

## 3M™ Cable Products

Twin Axial Cable.....	4-5
Low Smoke Zero Halogen (LSZH) Cable .....	6-7
Flat Ribbon Cable .025" - .033" Pitch.....	8-9
Flat Ribbon Cable 1 mm Pitch.....	9
Flat Ribbon Cable .050" Pitch .....	10-11
Flat Ribbon Cable .100" - .156" Pitch .....	12
Color Coded Flat Cable .....	13
Twisted Pair Flat Cable .....	13
Ground Plane Cable.....	14
Jacketed Flat Ribbon Cable .....	14-15
Pleated Foil Flat Cable.....	15-16
Round Jacketed Flat Cable.....	17
Round Jacketed Discrete Cable For Factory Automation.....	18
Twisted Pair Round Jacketed Cable .....	18-19
Cable Accessories .....	20

# 3M™ Twin Axial Cable, SL8800 Series

After designing cables for over 50 years, we understand what it takes to design, build, deliver and install high-performance devices on time and on budget.

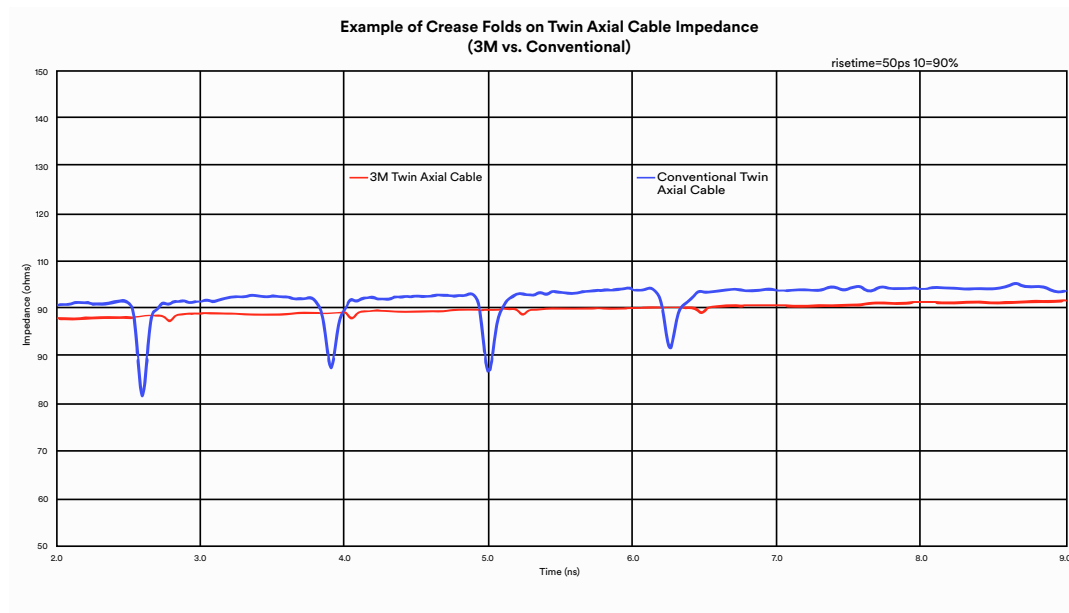

The 3M Twin Axial Cable, SL8800 Series is designed to bring together high-speed performance and high signal density in an extremely thin and flexible package that can be folded with minimal loss or impact on performance. With its ultra-low, space-saving profile, the SL8800 Series helps allow for optimal cooling and airflow to maintain the high speeds and processing power your system demands.



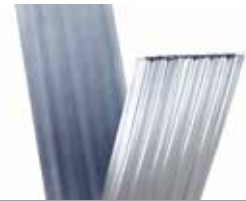
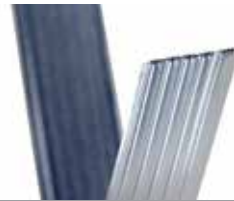

Comparative Example of Crease Folds on 3M™ Twin Axial Cable Differential Impedance (3M vs. Conventional Spiral Wrapped)

# 3M™ Twin Axial Cable, SL8800 Series (cont.)



Cable Type/Description	Twin Axial Cable	Twin Axial Cable	Twin Axial Cable
<b>Profile</b>			
<b>3M Cable Series</b>	<b>8801</b>	<b>8801</b>	<b>8801</b>
<b>Conductor Size (AWG)</b>	30	30	30
<b>Conductor Material</b>	Copper	Copper	Copper
<b>Primary Insulation</b>	Polyolefin	Polyolefin	Polyolefin
<b>Primary Color</b>	Gray	Gray	Gray
<b>3M Drawing Number</b>	78-5100-2412-4	78-5100-2463-7	78-5100-2462 -9
<b>Application Examples (cable is not limited to these)</b>	SAS/SATA internal, other 4/8-pair applications requiring sidebands	SAS implemented on 68-position internal assemblies; can be doubled up or matched with other configurations	PCIe implemented on 36-position assemblies



Cable Type/Description	Twin Axial Cable	Twin Axial Cable	Twin Axial Cable
<b>Profile</b>			
<b>3M Cable Series</b>	<b>8802</b>	<b>8802</b>	<b>8803</b>
<b>Conductor Size (AWG)</b>	30	30	30
<b>Conductor Material</b>	Copper	Copper	Copper
<b>Primary Insulation</b>	Polyolefin	Polyolefin	Polyolefin
<b>Primary Color</b>	Gray	Gray	Gray
<b>3M Drawing Number</b>	78-5100-2413-2	78-5100-2400-9	78-5100-2414-0
<b>Application Examples (cable is not limited to these)</b>	SAS/SATA internal assemblies not requiring sidebands; other 4/8-pair internal assemblies	HD SAS SFF 8643	SAS and/or SATA fanout assemblies; cable can be split into individual pairs

# 3M™ Low Smoke Zero Halogen (LSZH) Cables

You asked for them, and we delivered.

LSZH Cables help minimize the risks associated with smoke and corrosive gasses.

And since these cables come from 3M, the increase in safety comes

without a dip in performance. The HF Series meets established industry low smoke (IEC 61034-2:2005) and low toxicity (NF X 70-100-2:2006) criteria with comparable

flexibility and durability to 3M's PVC Cables. 3M's LSZH Cables are halogen-free

as defined by IEC 61249-2-21. As you'd expect, this makes the HF Series ideal for

electronics, especially in data center, transportation and military

applications.

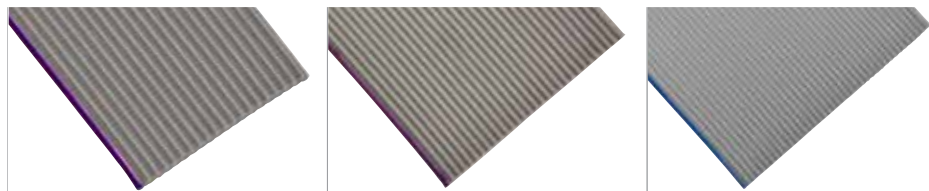

Cable Type/Description	Round Conductor Flat Cable	Round Conductor Flat Cable	Round Conductor Flat Cable, High Flex Life
Pitch/Centerline in. (mm)	.025 (0.635)	.039 (1.0)	.050 (1.27)
3M Cable Series	HF447	HF625	HF319
Conductor Size (AWG)	30	28	28
Conductor Material	Tinned Copper	Tinned Copper	Silver Plated Copper Alloy
Conductor Stranding	Solid	7 × 0.127 (7 × 36)	19 × 0.079 (19 × 40)
Primary Insulation	Polyolefin Blend	Polyolefin Blend	Polyolefin Blend
Primary Color	Dark Gray	Dark Gray	Dark Gray
3M Drawing Number	TS-2343	TS-2338	TS-2342

# 3M™ Low Smoke Zero Halogen (LSZH) Cable (cont.)



Cable Type/Description	Round Conductor Flat Cable	Twisted Pair Flat Cable
Pitch/Centerline in. (mm)	.050 (1.27)	.050 (1.27)
3M Cable Series	HF365	HF100
Conductor Size (AWG)	28	28
Conductor Material	Tinned Copper	Tinned Copper
Conductor Stranding	7 × 0.127 (7 × 36)	7 × 0.127 (7 × 36)
Primary Insulation	Polyolefin Blend	Polyolefin Blend
Primary Color	Dark Gray	Blue/Off-White Pairs
3M Drawing Number	TS-2334	TS-2344



Cable Type/Description	Shielded, Jacketed Flat Cable	Round Jacketed Flat Cable	Round, Shielded, Jacketed, Flat Cable
Pitch/Centerline in. (mm)	.050 (1.27)	.050 (1.27)	.050 (1.27)
3M Cable Series	HF017	HF759	HF659
Conductor Size (AWG)	28	28	28
Conductor Material	Tinned Copper	Not Applicable	Tinned Copper
Conductor Stranding	7 × 0.127 (7 × 36)	7 × 0.127 (7 × 36)	7 × 0.127 (7 × 36)
Primary Insulation	Polyolefin Blend	Polyolefin Blend	Polyolefin Blend
Primary Color	Dark Gray	Dark Gray	Dark Gray
Jacket Insulation	Polyolefin	Polyolefin	Polyolefin
Jacket Color	Dark Gray	Dark Gray	Dark Gray
3M Drawing Number	TS-2345	TS-2336	TS-2335

# 3M™ Flat Ribbon Cable .025" - .033" Pitch

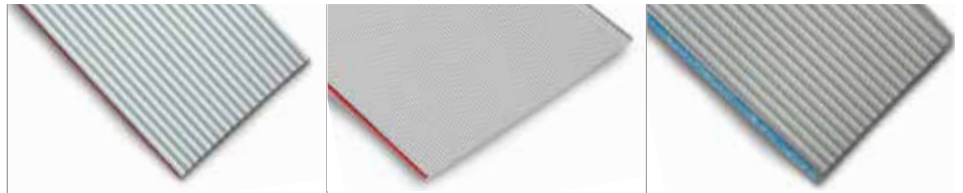

Cable Type/Description	Round Conductor Flat Cable	Round Conductor Flat Cable	Round Conductor Flat Cable
Pitch/Centerline in. (mm)	.025 (0.635)	.025 (0.635)	.025 (0.635)
3M Cable Series	3754	3447	3756
Conductor Size (AWG)	30	30	30
Conductor Material	Tinned Copper	Tinned Copper	Tinned Copper
Conductor Stranding	7 × 0.102 (7 × 38)	Solid	7 × 0.102 (7 × 38)
Primary Insulation	PVC	PVC	TPE
Primary Color	Gray	Gray	Gray
3M Drawing Number	TS-0875	TS-0830	TS-0508

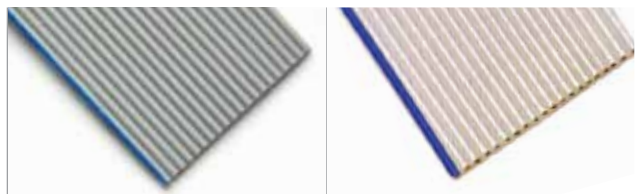

Cable Type/Description	Round Conductor Flat Cable	Round Conductor Flat Cable
Pitch/Centerline in. (mm)	.025 (0.635)	.025 (0.635)
3M Cable Series	3749	3609
Conductor Size (AWG)	30	30
Conductor Material	Tinned Copper	Silver Plated Copper
Conductor Stranding	Solid	7 × 0.102 (7 × 38)
Primary Insulation	TPE	FEP
Primary Color	Gray	Opaque White
3M Drawing Number	TS-0068	TS-0654



## 3M™ Flat Ribbon Cable .025" - .033" Pitch (cont.)

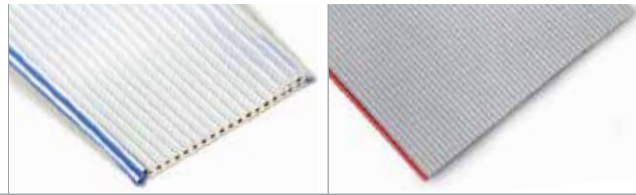

Cable Type/Description	Round Conductor Flat Cable	Round Conductor Flat Cable
Pitch/Centerline in. (mm)	<b>.025 (0.635)</b>	<b>.033 (0.838)</b>
<b>3M Cable Series</b>	<b>3604</b>	<b>3849</b>
Conductor Size (AWG)	30	30
Conductor Material	Silver Plated Copper	Tinned Copper
Conductor Stranding	Solid	7 × 0.102 (7 × 38)
Primary Insulation	FEP	PVC
Primary Color	Opaque White	Gray
3M Drawing Number	TS-0653	TS-0573

## 3M™ Flat Ribbon Cable 1 mm Pitch

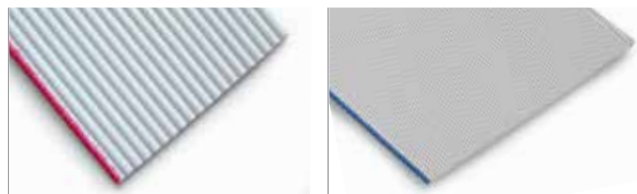

Cable Type/Description	Round Conductor Flat Cable	Round Conductor Flat Cable
Pitch/Centerline in. (mm)	<b>.039 (1.0)</b>	<b>.039 (1.0)</b>
<b>3M Cable Series</b>	<b>3625</b>	<b>3852</b>
Conductor Size (AWG)	28	28
Conductor Material	Tinned Copper	Tinned Copper
Conductor Stranding	7 × 0.127 (7 × 36)	41/44
Primary Insulation	PVC	PVC
Primary Color	Gray	Gray
3M Drawing Number	TS-0452	TS-2540

## 3M™ Flat Ribbon Cable .050" Pitch



Cable Type/Description	Round Conductor Flat Cable	Round Conductor Flat Cable	Round Conductor Flat Cable
Pitch/Centerline in. (mm)	<b>.050 (1.27)</b>	<b>.050 (1.27)</b>	<b>.033 (0.838)</b>
3M Cable Series	<b>3365</b>	<b>3365NS</b>	<b>3365A</b>
Conductor Size (AWG)	28	28	28
Conductor Material	Tinned Copper	Tinned Copper	Tinned Copper
Conductor Stranding	7 × 0.127 (7 × 36)	7 × 0.127 (7 × 36)	7 × 0.127 (7 × 36)
Primary Insulation	PVC	PVC	PVC
Primary Color	Gray	Gray (No Stripe)	Black
3M Drawing Number	TS-0080	TS-0080	TS-0080

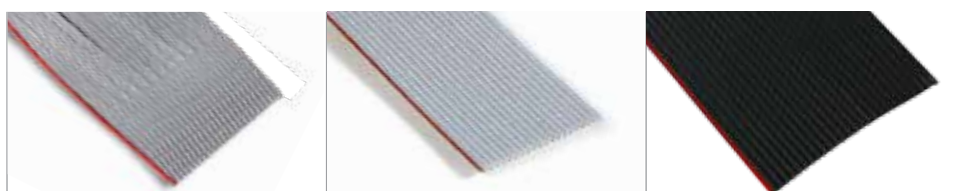

Cable Type/Description	Round Conductor Flat Cable	Round Conductor Flat Cable, Medium Flex Life	Round Conductor Flat Cable, Medium Flex Life
Pitch/Centerline in. (mm)	<b>.050 (1.27)</b>	<b>.050 (1.27)</b>	<b>.050 (1.27)</b>
3M Cable Series	<b>3667</b>	<b>3539</b>	<b>3539A</b>
Conductor Size (AWG)	28	28	28
Conductor Material	Tinned Copper	Tinned Copper	Tinned Copper
Conductor Stranding	7 × 0.127 (7 × 36)	19 × 0.079 (19 × 40)	19 × 0.079 (19 × 40)
Primary Insulation	PVC	PVC	PVC
Primary Color	Gray	Gray	Black
3M Drawing Number	TS-0247	TS-0058	TS-0058

## 3M™ Flat Ribbon Cable .050" Pitch (cont.)

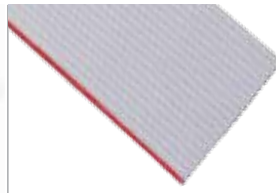
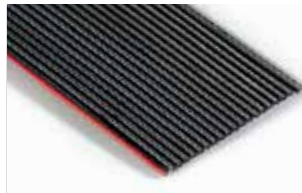

Cable Type/Description	Round Conductor Flat Cable, High Flex Life	Round Conductor Flat Cable	Round Conductor Flat Cable
Pitch/Centerline in. (mm)	.050 (1.27)	.050 (1.27)	.050 (1.27)
3M Cable Series	3319	3801	3801A
Conductor Size (AWG)	28	26	26
Conductor Material	Silver Plated Copper Alloy	Tinned Copper	Tinned Copper
Conductor Stranding	19 × 0.079 (19 × 40)	7 × 0.160 (7 × 34)	7 × 0.160 (7 × 34)
Primary Insulation	PVC	PVC	PVC
Primary Color	Black	Gray	Black
3M Drawing Number	TS-0059	TS-0063	TS-0063

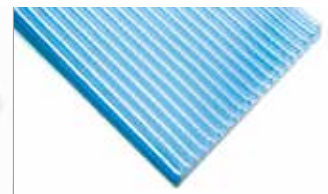
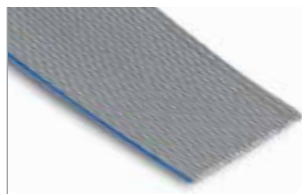

Cable Type/Description	Round Conductor Flat Cable	Round Conductor Flat Cable	Round Conductor Flat Cable
Pitch/Centerline in. (mm)	.050 (1.27)	.050 (1.27)	.050 (1.27)
3M Cable Series	3355	3770	3601
Conductor Size (AWG)	28	26	28
Conductor Material	Tinned Copper	Tinned Copper	Silver Plated Copper
Conductor Stranding	7 × 0.127 (7 × 36)	7 × 0.160 (7 × 34)	7 × 0.127 (7 × 36)
Primary Insulation	TPE	TPE	FEP
Primary Color	Gray	Gray	Blue
3M Drawing Number	TS-0317	TS-0342	TS-0553

# 3M™ Flat Ribbon Cable .100" - .156" Pitch

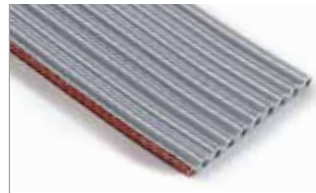
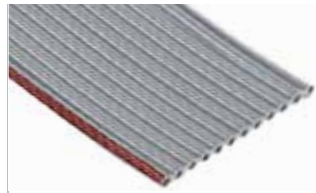

Cable Type/Description	Round Conductor Flat Cable	Round Conductor Flat Cable	Round Conductor Flat Cable for 3M™ Link Connectors
Pitch/Centerline in. (mm)	.100 (2.54)	.100 (2.54)	.100 (2.54)
3M Cable Series	8125	8124	79100-075-4F1
Conductor Size (AWG)	24	22	19
Conductor Material	Tinned Copper	Tinned Copper	Tinned Stranded Copper
Conductor Stranding	7 × 0.203 (7 × 32)	7 × 0.254 (7 × 30)	0.75 mm <sup>2</sup> (19 AWG), 30 strands × 0.18 mm (33 AWG)
Primary Insulation	PVC	PVC	PVC
Primary Color	Dark Gray	Dark Gray	Black, Red, White, Green
3M Drawing Number	TS-0259	TS-0084	TS-2323



Cable Type/Description	Round Conductor Flat Cable for CC-Link/LT	Round Conductor Flat Cable
Pitch/Centerline in. (mm)	.100 (2.54)	.156 (3.96)
3M Cable Series	79100-075-4FLT	8132
Conductor Size (AWG)	18	18
Conductor Material	Tinned Stranded Copper	Tinned Copper
Conductor Stranding	0.75 mm <sup>2</sup> (18 AWG), 35 strands × 0.18 mm (33 AWG)	19 × 30 (19 × 0.254)
Primary Insulation	PVC	PVC
Primary Color	Light Blue with Orange stripe	Dark Gray
3M Drawing Number	TS-2322	TS-0057

## 3M™ Color Coded Flat Cable



Cable Type/Description	Color Coded Flat Cable	Color Coded Flat Cable
Pitch/Centerline in. (mm)	.050 (1.27)	.050 (1.27)
<b>3M Cable Series</b>	<b>3302</b>	<b>3811</b>
Conductor Size (AWG)	28	26
Conductor Material	Tinned Copper	Tinned Copper
Conductor Stranding	7 × 0.127 (7 × 36)	7 × 0.160 (7 × 34)
Primary Insulation	PVC	PVC
Primary Color	10 Color Repeat	10 Color Repeat
3M Drawing Number	TS-0123	TS-0122

## 3M™ Twisted Pair Flat Cable



Cable Type/Description	Twisted Pair Flat Cable	Twisted Pair Flat Cable
Pitch/Centerline in. (mm)	.050 (1.27)	.050 (1.27)
<b>3M Cable Series</b>	<b>1700</b>	<b>3782</b>
Conductor Size (AWG)	28	28
Conductor Material	Tinned Copper	Tinned Copper
Conductor Stranding	7 × 0.127 (7 × 36)	7 × 0.127 (7 × 36)
Primary Insulation	PVC	PVC
Primary Color	10 Color Repeat	10 Color Repeat + White
3M Drawing Number	TS-0115	TS-0999

# 3M™ Ground Plane Cable



Cable Type/Description	Ground Plane Flat Cable	Ground Plane Flat Cable	Ground Plane Flat Cable
Pitch/Centerline in. (mm)	.050 (1.27)	.050 (1.27)	.050 (1.27)
3M Cable Series	3469	3476	3353
Conductor Size (AWG)	28	28	28
Conductor Material	Tinned Copper	Tinned Copper	Tinned Copper
Conductor Stranding	7 × 0.127 (7 × 36)	7 × 0.127 (7 × 36)	7 × 0.127 (7 × 36)
Primary Insulation	PVC	PVC	PVC
Primary Color	Gray	Gray	Gray
Jacket Insulation	Not Applicable	Not Applicable	Not Applicable
Jacket Color	Not Applicable	Not Applicable	Not Applicable
3M Drawing Number	TS-0077	TS-0071	TS-0078

# 3M™ Jacketed Flat Ribbon Cable



Cable Type/Description	Jacketed Flat Cable	Jacketed Flat Cable	Shielded, Jacketed Flat Cable
Pitch/Centerline in. (mm)	.050 (1.27)	.050 (1.27)	.050 (1.27)
3M Cable Series	3603	3602	3517
Conductor Size (AWG)	28	26	28
Conductor Material	Tinned Copper	Tinned Copper	Tinned Copper
Conductor Stranding	7 × 0.127 (7 × 36)	7 × 0.160 (7 × 34)	7 × 0.127 (7 × 36)
Primary Insulation	PVC	PVC	PVC
Primary Color	Gray	Gray	Gray
Jacket Insulation	PVC	PVC	PVC
Jacket Color	Black	Black	Black
3M Drawing Number	TS-0060	TS-1064	TS-0069

## 3M™ Jacketed Flat Ribbon Cable (cont.)



Cable Type/Description	Shielded, Jacketed Flat Cable	Shielded, Jacketed Flat Cable	Shielded, Jacketed, Twisted Pair Flat Cable
Pitch/Centerline in. (mm)	.039 (1.0)	.039 (1.0)	.050 (1.27)
3M Cable Series	3844	3855	1785
Conductor Size (AWG)	28	28	28
Conductor Material	Tinned Copper	Tinned Copper	Tinned Copper
Conductor Stranding	7 × 0.127 (7 × 36)	7 × 0.127 (7 × 36)	7 × 0.127 (7 × 36)
Primary Insulation	PVC	PVC	PVC
Primary Color	Gray	Gray	10 Color Repeat + Tan (Ground)
Jacket Insulation	PVC	PVC	PVC
Jacket Color	Black	Black	Black
3M Drawing Number	TS-2311	TS-2333	TS-0308

## 3M™ Pleated Foil Flat Cable



Cable Type/Description	Pleated Foil Shielded Flat Cable	Pleated Foil Shielded Flat Cable	Pleated Foil Shielded Flat Cable
Pitch/Centerline in. (mm)	.025 (0.635)	.025 (0.635)	.025 (0.635)
3M Cable Series	90111	90101	90202
Conductor Size (AWG)	30	30	30
Conductor Material	Tinned Copper	Tinned Copper	Tinned Copper
Conductor Stranding	Solid	Solid	7 × 0.102 (7 × 38)
Primary Insulation	TPE	TPE	TPE
Primary Color	Translucent	Translucent	Gray
Jacket Insulation	PVC	PVC	TPE
Jacket Color	Gray	Gray	Gray
3M Drawing Number	TS-0451	TS-0285	TS-0730

## 3M™ Pleated Foil Flat Cable (cont.)

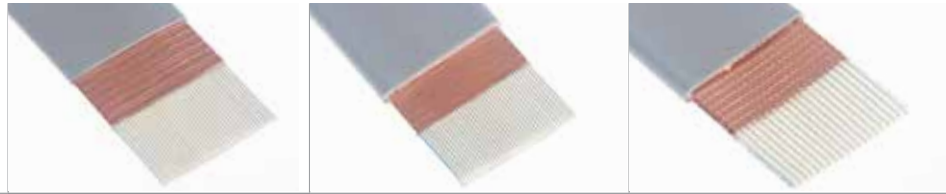

Cable Type/Description	Pleated Foil Shielded Flat Cable	Pleated Foil Shielded Flat Cable	Pleated Foil Shielded Flat Cable
Pitch/Centerline in. (mm)	.025 (0.635)	.025 (0.635)	.050 (1.27)
3M Cable Series	90201	90211	90104
Conductor Size (AWG)	30	30	28
Conductor Material	Tinned Copper	Tinned Copper	Tinned Copper
Conductor Stranding	Solid	Solid	7 × 0.127 (7 × 36)
Primary Insulation	TPE	TPE	TPE
Primary Color	Translucent	Translucent	Translucent
Jacket Insulation	TPE	TPE	PVC
Jacket Color	Gray	Gray	Gray
3M Drawing Number	TS-0402	TS-0598	TS-0288



Cable Type/Description	Pleated Foil Shielded Flat Cable	Pleated Foil Shielded Flat Cable
Pitch/Centerline in. (mm)	.050 (1.27)	.025 (0.635)
3M Cable Series	90204	93101
Conductor Size (AWG)	28	30
Conductor Material	Tinned Copper	Tinned Copper
Conductor Stranding	7 × 0.127 (7 × 36)	Solid
Primary Insulation	TPE	TPE
Primary Color	Translucent	Translucent
Jacket Insulation	TPE	PVC
Jacket Color	Gray	Gray
3M Drawing Number	TS-0403	TS-0876



# 3M™ Round Jacketed Flat Cable

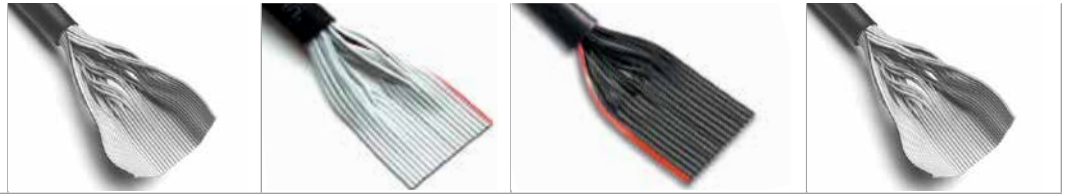

Cable Type/Description	Round Jacketed Flat Cable	Round Jacketed Flat Cable	Round Jacketed Flat Cable, High Flex Life	Round Jacketed Flat Cable
Pitch/Centerline in. (mm)	.025 (0.635)	.050 (1.27)	.050 (1.27)	.050 (1.27)
3M Cable Series	3896	3759	3834	3758
Conductor Size (AWG)	30	28	28	26
Conductor Material	Tinned Copper	Tinned Copper	Silver Plated Stranded Copper	Tinned Copper
Conductor Stranding	7 × 0.102 (7 × 38)	7 × 0.127 (7 × 36)	19 × 0.079 (19 × 40)	7 × 0.160 (7 × 34)
Primary Insulation	PVC	PVC	PVC	PVC
Primary Color	Gray	Gray	Black	Gray
Jacket Insulation	PVC	PVC	PVC	PVC
Jacket Color	Black	Black	Black	Black
3M Drawing Number	TS-2173	TS-0070	TS-1006	TS-2200



Cable Type/Description	Round Jacketed Twisted Pair Flat Cable	Round, Shielded, Jacketed, Flat Cable	Round, Jacketed, Shielded Twisted Pair Flat Cable
Pitch/Centerline in. (mm)	.050 (1.27)	.050 (1.27)	.050 (1.27)
3M Cable Series	3783	3659	3784
Conductor Size (AWG)	28	28	28
Conductor Material	Tinned Copper	Tinned Copper	Tinned Copper
Conductor Stranding	7 × 0.127 (7 × 36)	7 × 0.102 (7 × 38)	7 × 0.127 (7 × 36)
Primary Insulation	PVC	PVC	PVC
Primary Color	10 Color Repeat + White	Gray	10 Color Repeat + White
Jacket Insulation	PVC	PVC	PVC
Jacket Color	Gray	Black	Gray
3M Drawing Number	TS-2249	TS-0083	TS-2250

## 3M™ Round Jacketed Discrete Cable for Factory Automation



Cable Type/Description	Round Conductor Round Cable for CC-Link/LT	Round Conductor Round Cable for CC-Link	Round Conductor Round Cable for CC-Link
Pitch/Centerline in. (mm)	Not Applicable	Not Applicable	Not Applicable
3M Cable Series	79100-075-4ZLT	79100-110SBZ-5	79100-110SBH
Conductor Size (AWG)	18	20	20
Conductor Material	Tinned Copper	Stranded Copper	Stranded Copper
Conductor Stranding	0.75 mm <sup>2</sup> (18 AWG), 7 strands x 0.08 mm (22 AWG)	0.50 mm <sup>2</sup> (20 AWG), 3/33 strands x 0.08 mm (22 AWG)	0.50 mm <sup>2</sup> (20 AWG), 3/33 strands x 0.08 mm (22 AWG)
Primary Insulation	ETFE (Fluorocarbon polymer)	PE (Polyethylene)	PE (Polyethylene)
Primary Color	Black, Red, White, Green	Yellow, White, Blue	Yellow, White, Blue
Jacket Insulation	Oil Resistant PVC	Oil Resistant PVC	Oil Resistant PVC
Jacket Color	Black	Dark Brown	Brown
3M Drawing Number	TS-2325	TS-2324	TS-2321

## 3M™ Twisted Pair Round Jacketed Cable



Cable Type/Description	Round, Shielded, Jacketed, Discrete Wire Cable	Round, Shielded, Jacketed, Discrete Wire Cable	Round, Shielded, Jacketed, Discrete Wire Cable
Pitch/Centerline in. (mm)	Not Applicable	Not Applicable	Not Applicable
3M Cable Series	3644A	3644B	3647B
Conductor Size (AWG)	28	28	28
Conductor Material	Tinned Copper	Tinned Copper	Not Applicable
Conductor Stranding	7 × 0.127 (7 × 36)	7 × 0.127 (7 × 36)	7 × 0.127 (7 × 36)
Primary Insulation	Polyolefin	Polyolefin	Polyolefin
Primary Color	Color Coded	Color Coded	Color Coded
Jacket Insulation	PVC	PVC	PVC
Jacket Color	Black	Beige	Beige
3M Drawing Number	TS-0826	TS-0826	TS-0582

## 3M™ Twisted Pair Round Jacketed Cable (Cont.)



Cable Type/Description	Round, Shielded, Jacketed, Discrete Flat Cable	Round, Shielded, Jacketed, Discrete Flat Cable	Round, Shielded, Jacketed, Discrete Flat Cable
Pitch/Centerline in. (mm)	Not Applicable	Not Applicable	Not Applicable
<b>3M Cable Series</b>	<b>KU-C-KMPVV</b>	<b>3600A</b>	<b>3600B</b>
Conductor Size (AWG)	28	28	28
Conductor Material	Tinned Copper	Tinned Copper	Tinned Copper
Conductor Stranding	7 × 0.127 (7 × 36)	7 × 0.127 (7 × 36)	7 × 0.127 (7 × 36)
Primary Insulation	PVC	PVC	PVC
Primary Color	Color Coded	Color Coded	Color Coded
Jacket Insulation	PVC	PVC	PVC
Jacket Color	Cream	Black	Beige
3M Drawing Number	TS-2173	TS-0388	TS-0388



Cable Type/Description	Round, Shielded, Jacketed, Discrete Flat Cable	Round, Shielded, Jacketed, Discrete Wire Cable	Round, Shielded, Jacketed, Discrete Wire Cable
Pitch/Centerline in. (mm)	Not Applicable	Not Applicable	Not Applicable
<b>3M Cable Series</b>	<b>3600G</b>	<b>3560</b>	<b>3750</b>
Conductor Size (AWG)	28	26	26
Conductor Material	Tinned Copper	Tinned Copper	Tinned Copper
Conductor Stranding	7 × 0.127 (7 × 36)	Solid	7 × 0.160 (7 × 34)
Primary Insulation	PVC	PVC	PVC
Primary Color	Color Coded	Color Coded	Color Coded
Jacket Insulation	PVC	PVC	PVC
Jacket Color	Gray	Gray	Gray
3M Drawing Number	TS-0388	TS-0672	TS-0072

# 3M™ Cable Accessories



Accessory Type	PVC Shielded Jacket	High Flex Life Braided Shield
<b>3M Cable Accessory Series</b>	<b>3617</b>	<b>DS/FS</b>
<b>Description</b>	Fits cable width sizes 1.5, 2.4 and 3.5 inch; .035 thick PVC jacket with expanded copper shield	0.2 - 0.6 inch diameter, 1.2 and 1.5 inch widths; conductive high flex cable shielding sleeve
<b>Conductor Material</b>	Not Applicable	Tinned copper foil wound spirally over glass fibers
<b>Primary Insulation</b>	PVC	Not Applicable
<b>Primary Color</b>	Black	Bright Tin
<b>3M Drawing Number</b>	TS-0308	TS-0713



Accessory Type	Drain Wire Spring Clip	Cable Clamp	Strain Relief Grounding Clamp
<b>3M Cable Accessory Series</b>	<b>3535</b>	<b>3484</b>	<b>3504</b>
<b>Description</b>	One size fits 9-64 conductor round cable; used to attach a ground wire to the shield of a round cable	Organizes cable by clamping and retaining; used to organize up to six layers of flat cable	Jacketed cable strain relief/grounding clamp; mounting brackets used to transfer stresses and strains to the cabinet and provide grounding
<b>Material</b>	Stainless Steel	PVC	Aluminum
<b>Primary Color</b>	Silver	Gray	Aluminum
<b>3M Drawing Number</b>	TS-0269	TS-0260	TS-0268

# Notes

# 3M™ Cable Product Index

Cable Series Number	Product Name	Page Number
1700	Twisted Pair Flat Cable	13
1785	Shielded, Jacketed Twisted Pair Flat Cable	15
3302	Color Coded Flat Cable	13
3319	Round Conductor Flat Cable, High Flex Life	11
3353	Ground Plane Flat Cable	14
3355	Round Conductor Flat Cable	11
3365	Round Conductor Flat Cable	10
3365A	Round Conductor Flat Cable	10
3365NS	Round Conductor Flat Cable	10
3447	Round Conductor Flat Cable	8
3469	Ground Plane Flat Cable	14
3476	Ground Plane Flat Cable	14
3484	Cable Clamp	20
3504	Strain Relief Grounding Clamp	20
3517	Shielded, Jacketed Flat Cable	14
3535	Drain Wire Spring Clip	20
3539	Round Conductor Flat Cable, Medium Flex Life	10
3539A	Round Conductor Flat Cable, Medium Flex Life	10
3560	Round, Shielded, Jacketed, Discrete Wire Cable	19
3600A	Round, Shielded, Jacketed, Discrete Flat Cable	19
3600B	Round, Shielded, Jacketed, Discrete Flat Cable	19
3600G	Round, Shielded, Jacketed, Discrete Flat Cable	19
3601	Round Conductor Flat Cable	11
3602	Jacketed Flat Cable	14
3603	Jacketed Flat Cable	14
3604	Round Conductor Flat Cable	9
3609	Round Conductor Flat Cable	8
3617	PVC Shielded Jacket	20
3625	Round Conductor Flat Cable	9
3644A	Round, Shielded, Jacketed, Discrete Wire Cable	18
3644B	Round, Shielded, Jacketed, Discrete Wire Cable	18
3647B	Round, Shielded, Jacketed, Discrete Wire Cable	18
3659	Round, Shielded, Jacketed, Flat Cable	17
3667	Round Conductor Flat Cable	10
3749	Round Conductor Flat Cable	8
3750	Round, Shielded, Jacketed, Discrete Wire Cable	19
3754	Round Conductor Flat Cable	8
3756	Round Conductor Flat Cable	8
3758	Round Jacketed Flat Cable	17
3759	Round Jacketed Flat Cable	17
3770	Round Conductor Flat Cable	11
3782	Twisted Pair Flat Cable	13
3783	Round Jacketed Twisted Pair Flat Cable	17
3784	Round, Jacketed, Shielded Twisted Pair Flat Cable	17
3801	Round Conductor Flat Cable	11
3801A	Round Conductor Flat Cable	11
3811	Color Coded Flat Cable	13
3834	Round Jacketed Flat Cable, High Flex Life	17
3844	Shielded, Jacketed Flat Cable	15
3849	Round Conductor Flat Cable	9
3852	Round Conductor Flat Cable	9

# 3M™ Cable Product Index

Cable Series Number	Product Name	Page Number
3855	Shielded, Jacketed Flat Cable	15
3896	Round Jacketed Flat Cable	17
8124	Round Conductor Flat Cable	12
8125	Round Conductor Flat Cable	12
8132	Round Conductor Flat Cable	12
8801	Twin Axial Cable	5
8802	Twin Axial Cable	5
8803	Twin Axial Cable	5
79100-075-4F1	Round Conductor Flat Cable for Link Connectors	12
79100-075-4FLT	Round Conductor Flat Cable for CC-Link/LT	12
79100-075-4ZLT	Round Conductor Round Cable for CC-Link/LT	18
79100-110SBH	Round Conductor Round Cable for CC-Link	18
79100-110SBZ-5	Round Conductor Round Cable for CC-Link	18
90101	Pleated Foil Shielded Flat Cable	15
90104	Pleated Foil Shielded Flat Cable	16
90111	Pleated Foil Shielded Flat Cable	15
90201	Pleated Foil Shielded Flat Cable	16
90202	Pleated Foil Shielded Flat Cable	15
90204	Pleated Foil Shielded Flat Cable	16
90211	Pleated Foil Shielded Flat Cable	16
93101	Pleated Foil Shielded Flat Cable	16
DS/FS	High Flex Life Braided Shield	20
HF017	LSZH Shielded, Jacketed Flat Cable	7
HF100	LSZH Twisted Pair Flat Cable	7
HF319	LSZH Round Conductor Flat Cable, High Flex Life	6
HF365	LSZH Round Conductor Flat Cable	8
HF447	LSZH Round Conductor Flat Cable	6
HF625	LSZH Round Conductor Flat Cable	6
HF659	LSZH Round, Shielded, Jacketed, Flat Cable	7
HF759	LSZH Round Jacketed Flat Cable	7
KU-C-KMPVV	Round, Shielded, Jacketed, Discrete Flat Cable	19

## AWG Conversion Table

AWG	Individual Strands		Overall Conductor Construction	
	Number	Outside Diameter mm / inch	Outside Diameter mm / inch	Cross Section mm <sup>2</sup> / Circ. Mils
22	1	0.643 / 0.0253	0.64 / 0.0253	0.326 / 640
22	7	0.254 / 0.0100	0.78 / 0.0300	0.355 / 700
22	19	0.160 / 0.0063	0.81 / 0.0320	0.382 / 750
24	1	0.510 / 0.0201	0.51 / 0.0201	0.205 / 404
24	7	0.203 / 0.0080	0.61 / 0.0240	0.227 / 448
24	19	0.127 / 0.0050	0.64 / 0.0250	0.241 / 475
26	1	0.404 / 0.0159	0.40 / 0.0159	0.128 / 253
26	7	0.160 / 0.0063	0.48 / 0.0190	0.141 / 275
26	19	0.102 / 0.0040	0.51 / 0.0200	0.149 / 304
28	1	0.320 / 0.0126	0.32 / 0.0126	0.080 / 124
28	7	0.127 / 0.0050	0.38 / 0.0150	0.089 / 175
28	19	0.080 / 0.0031	0.40 / 0.0160	0.092 / 201
30	1	0.250 / 0.0100	0.25 / 0.0100	0.050 / 100
30	7	0.102 / 0.0040	0.30 / 0.0120	0.057 / 112

**Visit [3Mconnectors.com](http://3Mconnectors.com) for more information.**

\*Advantages of LSZH insulation are the low smoke (IEC 61034-2:2005), low toxicity of combustion gases (NF X 70-100-2:2006), reducing the risk to firefighters and reducing the soot and corrosion damage to nearby equipment. "RoHS Compliant 2002/95/EC" means that the product or part ("Product") does not contain any of the substances in excess of the maximum concentration values in EU Directive 2002/95/EC, as amended by Commission Decision 2005/618/EC, unless the substance is in an application that is exempt under EU RoHS. This information represents 3M's knowledge and belief, which may be based in whole or in part on information provided by third party suppliers to 3M. In the event any product is proven not to conform with 3M's Regulatory Information Appendix, then 3M's entire liability and Buyer's exclusive remedy will be in accordance with the Warranty statement below.

3M is a trademark of 3M Company.

#### **Important Notice**

All statement, technical information, and recommendations related to 3M's products are based on information believed to be reliable, but the accuracy or completeness is not guaranteed. Before using this product, you must evaluate it and determine if it is suitable for your intended application. You assume all risks and liability associated with such use. Any statements related to the product which are not contained in 3M's current publications, or any contrary statements contained on your purchase order shall have no force or effect unless expressly agreed upon, in writing, by an authorized officer of 3M.

#### **Warranty; Limited Remedy; Limited Liability.**

This product will be free from defects in material and manufacture for a period of 1 year from the time of purchase. **3M MAKES NO OTHER WARRANTIES INCLUDING, BUT NOT LIMITED TO, ANY IMPLIED WARRANTY OF MERCHANTABILITY OF FITNESS FOR A PARTICULAR PURPOSE.** If this product is defective within the warranty period stated above, your exclusive remedy shall be, at 3M's option, to replace or repair the 3M product or refund the purchase price of the 3M product. **Except where prohibited by law, 3M will not be liable for any loss or damage arising from this 3M product, whether direct, indirect, special, incidental or consequential regardless of the legal theory asserted.**



Electronics Materials Solutions Division  
Interconnect Products  
6801 River Place Blvd.  
Austin, TX 78726-9000 USA

Phone 1-800-225-5373  
Fax 1-800-325-5329  
Web [3Mconnectors.com](http://3Mconnectors.com)

Please recycle. Printed in USA © 3M 2015.  
All rights reserved. 80-4000-7001-9



## X-ON Electronics

Largest Supplier of Electrical and Electronic Components

*Click to view similar products for [Ribbon Cables / IDC Cables](#) category:*

*Click to view products by [3M](#) manufacturer:*

Other Similar products are found below :

[FSK-12A](#) [AWG28-10G](#) [EHJ3C](#) [EHJ4C](#) [FSP-25A](#) [cab-LVDV-DAT-34-15](#) [49635-C62-S2](#) [1-3636-600-5204](#) [92315-1408](#) [426171120-3](#) [2-1589735-3](#) [JSM015PP2DCC23N](#) [92301-0283](#) [ACL-eSSI-2](#) [92301-0718](#) [MMSDT-06-20-S-05.5-D-K-LDX](#) [IDD-04-G](#) [IDD-25-G](#) [NM-2J2-051-PS1-JJAB](#) [1700/26SF \(100FT\)](#) [1700/34SF \(100FT\)](#) [3801/09 \(100FT\)](#) [S30109](#) [96053-0000-00-0](#) [NM-2J2-065-SS1-JJ00-272](#) [7940098862](#) [IDMD-13-D-07.87](#) [166466](#) [HQCD-030-40.00-TTL-SBL-1-N](#) [HDR-201768-01-PCIEC](#) [DS1052-082B2NA201501](#) [DS1052-102B2NA201501](#) [DS1052-122B2MA201501](#) [DS1052-122B2NA201501](#) [DS1052-262B2NA201501](#) [DS1052-302B2MA201501](#) [DS1052-302B2MA203001](#) [DS1052-302B2MA206001](#) [DS1052-302B2NA201501](#) [DS1052-302B2NA203001](#) [DS1052-302B2NA206001](#) [DS1052-342B2MA201501](#) [DS1052-342B2MA203001](#) [DS1052-342B2NA201501](#) [DS1052-342B2NA203001](#) [DS1052-342B2NA206001](#) [DS1052-402B2MA201501](#) [DS1052-402B2MA203001](#) [DS1052-402B2MA206001](#) [DS1052-402B2NA201501](#)