

3M™ Mini-Clamp Plug

Designed for Wiring Supplied from Japan and Asia, 2 mm, IDC, Wiremount

371 Series



- Designed to accommodate typical wiring specifications per Japanese and Asian suppliers
- No special wire preparation
- Integrated cable retention
- Design accepts multiple wire size diameters
- Easy, quick, and reliable IDC termination using a standard pliers
- Debris free wire termination
- Mating latches provide a reliable interconnection in demanding applications
- High number of mating cycles
- Compact design saves board space
- Helps reduce maintenance work by providing higher connection reliability
- See Regulatory Information Appendix (RIA) for chemical compliance information

Date Modified: May 11, 2020

TS-2092-E
Sheet 1 of 3

Physical

Insulation:

Material: Glass reinforced thermoplastic body & lower cover, transparent thermoplastic cover
Flammability: UL 94V-0
Color: Black body, cover-white & color (see Table 1)

Contact:

Material: Copper Alloy

Plating:

Underplating: 2.54 μm [100 μ''] minimum Nickel
Wiping Area:: 0.2 μm [8 μ''] minimum Gold with Lubricant
IDC: Nickel

Accommodation: Annealed Copper, high-strength Copper, or Copper Alloy. Bare, tinned, or tin overcoated, 20~26 AWG [0.14~0.5] stranded

Wire Insulation: Flexible vinyl, semi-rigid vinyl, x-linked polyethylene, or ETFE (see Table 1)

Marking: 3M Logo, Position Indicator, Wire Gauge, Insulator Material

Electrical

Current Rating: 3.0 Amps

Voltage Rating: 32 Volts

Insulation Resistance: $>1 \times 10^6 \Omega$ at 600 V_{DC}

Withstanding Voltage: 1,000 V_{RMS} at sea level

Environmental

Temperature Rating: -20°C to +85°C ambient (1.0 A max.)
-20°C to +75°C ambient (2.0 A max.)
-20 C to +60°C ambient (3.0 A max.)
(Note: UL rating is 65°C at 3.0A, 32V)

UL File No.: E68080

3M

Electronics Materials Solutions Division
Interconnect Solutions
<http://www.3M.com/interconnect>

3M is a trademark of 3M Company.
For technical, sales or ordering information call
800-225-5373

3M™ Mini-Clamp Plug

Designed for Wiring Supplied from Japan and Asia, 2 mm, IDC, Wiremount

371 Series

3 and 4 Position

| # Positions | Dim A |
|-------------|-------------|
| 3 | 10.4 [0.41] |
| 4 | 12.4 [0.49] |



| Wire OD | 1.6 ~ 2.0 [.063 ~ .079] | 1.2 ~ 1.6 [.047 ~ .063] | 1.0 ~ 1.2 [.039 ~ .047] | 0.8 ~ 1.0 [.031 ~ .039] |
|---------------------|----------------------------|----------------------------|----------------------------|----------------------------|
| Part # 20-22 AWG | 2206 | 2165 | 2124 | |
| Cover Color | Gray | Blue | Green | |
| Part # 24-26 AWG | | 3163 | 3122 | 3101 |
| Color | | Orange | Yellow | Red |



| | mm [Inch] | |
|------------------------|--------------|------|
| Tolerance Unless Noted | | |
| | 0.0 | 0.00 |
| mm | ±.1 | ±.01 |

[] Dimensions for Reference only

Ordering Information

371XX - XXXX - 000 FL (RIA E1 & C1 apply)

Positions
03 or 04

Wire AWG & OD:
2XXX = 20-22 AWG
3XXX = 24-26 AWG
Wire OD - see Table 1

Note: Terminate using common pliers or 3M™ Scotchlok™ Crimping Tools E-9BM or E-9E

TS-2092-E
Sheet 2 of 3

3M™ Mini-Clamp Plug

Designed for Wiring Supplied from Japan and Asia, 2 mm, IDC, Wiremount

371 Series

6 and 8 Position

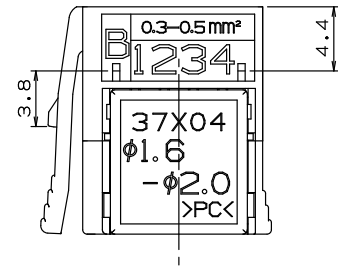
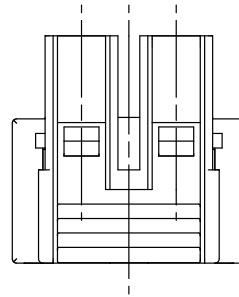
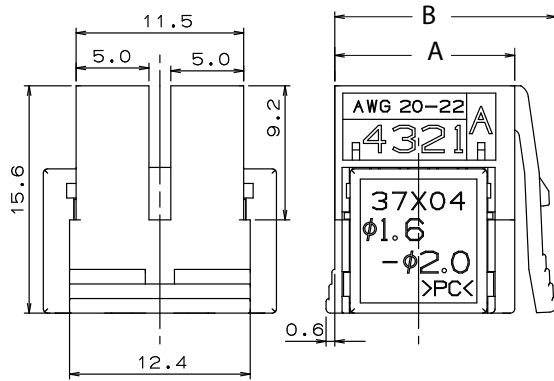
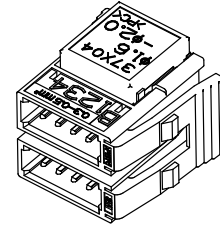
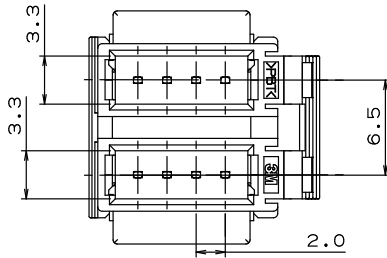

Before IDC

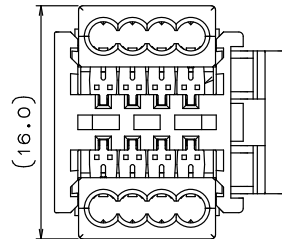

After IDC

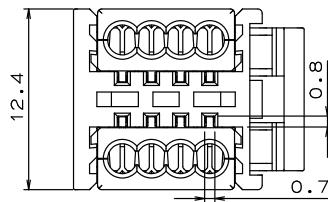

mm
[Inch]

| Tolerance Unless Noted | | |
|------------------------|-----|------|
| | .0 | .00 |
| mm | ±.1 | ±.10 |

[] Dimensions for Reference only

| # Positions | A | B (Ref.) |
|-------------|-------------|-------------|
| 6 (3x2) | 10.4 [0.41] | 13.2 [0.52] |
| 8 (4x2) | 12.4 [0.49] | 15.2 [0.60] |

Ordering Information

371XX - XXXX - 0W0 FL

Positions
06 or 08

Wire AWG & OD:
2XXX = 20-22 AWG
3XXX = 24-26 AWG
Wire OD – see Table

Note: Terminate using common pliers or 3M™ Scotchlok™ Crimping Tools E-9BM or E-9E

TS-2092-E
Sheet 3 of 3



Electronics Materials Solutions Division
Interconnect Solutions
<http://www.3M.com/interconnect>

3M is a trademark of 3M Company.
For technical, sales or ordering information call
800-225-5373

Regulatory: For regulatory information about this product, visit 3M.com/regs or contact your 3M representative.

Technical Information: The technical information, recommendations and other statements contained in this document are based upon tests or experience that 3M believes are reliable, but the accuracy or completeness of such information is not guaranteed.

Product Use: Many factors beyond 3M's control and uniquely within user's control can affect the use and performance of a 3M product in a particular application. Given the variety of factors that can affect the use and performance of a 3M product, user is solely responsible for evaluating the 3M product and determining whether it is fit for a particular purpose and suitable for user's method of application.

Warranty, Limited Remedy, and Disclaimer: Unless an additional warranty is specifically stated on the applicable 3M product packaging or product literature, 3M warrants that each 3M product meets the applicable 3M product specification at the time 3M ships the product. 3M MAKES NO OTHER WARRANTIES OR CONDITIONS, EXPRESS OR IMPLIED, INCLUDING, BUT NOT LIMITED TO, ANY IMPLIED WARRANTY OR CONDITION OF MERCHANTABILITY OR FITNESS FOR A PARTICULAR PURPOSE OR ANY IMPLIED WARRANTY OR CONDITION ARISING OUT OF A COURSE OF DEALING, CUSTOM OR USAGE OR TRADE.

If the 3M product does not conform to this warranty, then the sole and exclusive remedy is, at 3M's option, replacement of the 3M product or refund of the purchase price.

Limitation of Liability: Except where prohibited by law, 3M will not be liable for any loss or damage arising from the 3M product, whether direct, indirect, special, incidental or consequential, regardless of the legal theory asserted, including warranty, contract, negligence or strict liability.

3M Business Center
Electronics Materials Solutions Division
13011 McCallen Pass, Bldg. C
Austin, TX 78753-5380
1-800-225-5373
www.3M.com/interconnect



Electronics Materials Solutions Division
Interconnect Solutions
<http://www.3M.com/interconnect>

Please recycle. Printed in USA.
© 3M 2020. All rights reserved.
RIA-2217B-D

3M is a trademark of 3M Company.

X-ON Electronics

Largest Supplier of Electrical and Electronic Components

Click to view similar products for [Headers & Wire Housings](#) category:

Click to view products by [3M](#) manufacturer:

Other Similar products are found below :

[892-18-020-10-001101](#) [58102-G61-06LF](#) [582553-1](#) [0009485154](#) [009176003701906](#) [0050291907](#) [LY20-4P-DT1-P1E-BR](#) [02.125.8002.8](#)
[609-3404](#) [61062-3](#) [622-0430](#) [622-3653LF](#) [63453-116](#) [636-1030](#) [636-1427](#) [636-3427](#) [636-4007](#) [641938-9](#) [641991-4](#) [644827-2](#) [65817-010LF](#)
[65817-015LF](#) [65863-015LF](#) [66207-023LF](#) [67095-007LF](#) [67601157](#) [68648-049](#) [70.362.1628.0](#) [70-4210](#) [70-4226B](#) [70-4853B](#) [707-5020](#) [707-5028](#) [71.350.2428.0](#) [71918-208LF](#) [71961-016LF](#) [733-134](#) [733-162](#) [754199-000](#) [760-3052](#) [787-8014-00](#) [79531-3000](#) [FCN-360C032-B](#) [FCN-367T-T012/H](#) [FCN-723D010/2](#) [80.063.4001.1](#) [800-90-001-10-001000](#) [800-90-010-10-002000](#) [801-43-002-10-013000](#) [801-43-006-10-002000](#)