

3M™ Mini-Clamp Socket

2 mm, Surfacemount, Right Angle

372 Series

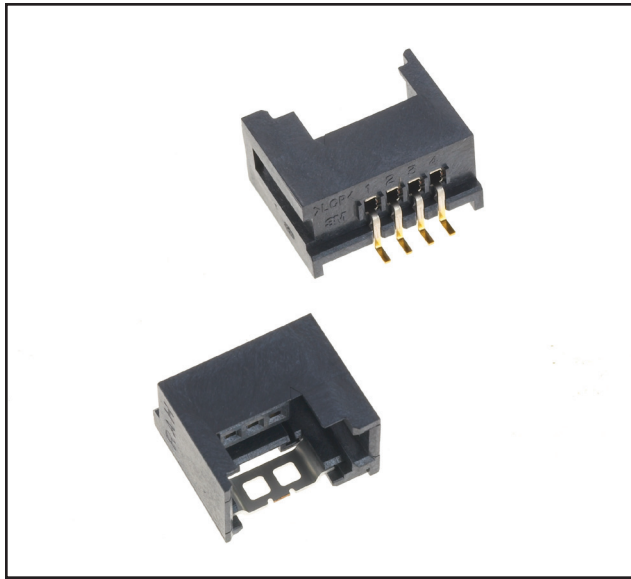

- Low profile design minimizes overall thickness
- Compact design saves board space
- Multiple PCB locating post layouts to ensure competitive compatibility
- Solder tab design helps ensure a reliable solder joint
- Mating Latch feature provides a reliable interconnection in demanding applications
- High number of mating cycles (300)
- Maximum current rating of 3 Amps
- Dust cover accessory available for use in harsh environment
- Available in Tape and Reel
- RoHS Compliant. See the Regulatory Information Appendix (RIA) in the “RoHS compliance” section of www.3Mconnector.com for compliance information (RIA E1 & C1 apply)

Date Modified: July 14, 2011

TS-2271-C
Sheet 1 of 4

Physical

Insulation:

Material: LCP
Flammability: UL 94V-0
Color: Black

Contact:

Material: Copper Alloy

Plating:

Underplating: 100 μ" [2.54 μm] Ni
Wiping Area: 0.2 μm [8 μ"] min Gold with Lubricant
Solder Tails: Gold Flash
Solder Tabs: 120 μ" min [3 μm min] Matte Sn over 40 μ"-120 μ" [1-3 μm] Ni

Marking: 3M Logo, Position Indicator, Insulator Material

Mating Compatibility: 371 Series

Electrical

Current Rating: 3.0 A

Voltage Rating: 32 V

Insulation Resistance: 1,000 MΩ minimum at 500 V_{DC}

Withstanding Voltage: 1,000 V_{RMS} for 1 minute

Environmental

Temperature Rating: -20°C to +85°C ambient (1.0 A max.)
-20°C to +75°C ambient (2.0 A max.)
-20°C to +60°C ambient (3.0 A max.)
(Note: UL rating is 65 C at 3.0 A, 32 V)

Process Rating: 260°C max. SMT reflow (J-STD-020 MSL1)
390°C max. for soldering iron

UL File No.: E68080

3M

Electronic Solutions Division
Interconnect Solutions
<http://www.3Mconnector.com>

3M is a trademark of 3M Company.
For technical, sales or ordering information call
800-225-5373

3M™ Mini-Clamp Socket

2 mm, Surfacement, Right Angle

372 Series

3 and 4 Position Socket

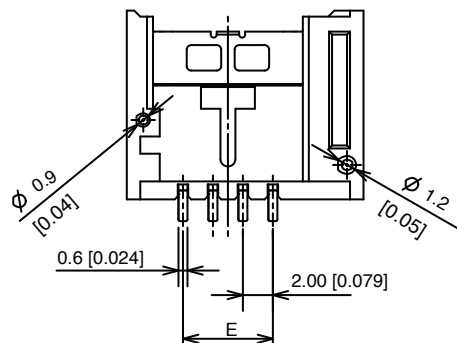
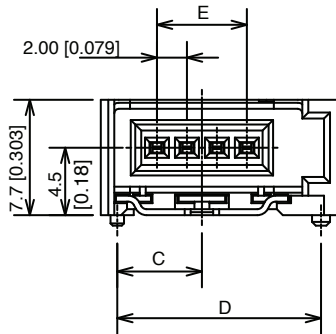
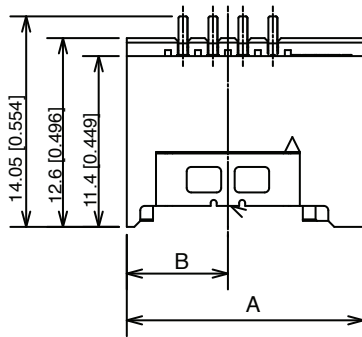

Locating Posts: None	Locating Posts: Yes
372XX-12E0-004 PL	372XX-1AE0-004 PL

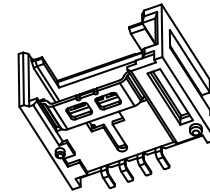
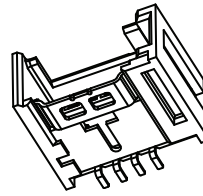

A Type

372XX-1BE0-004 PL

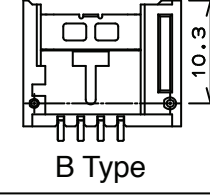
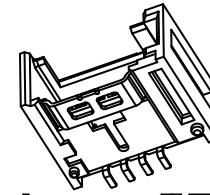

B Type

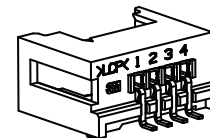
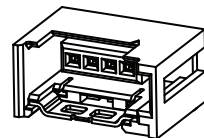
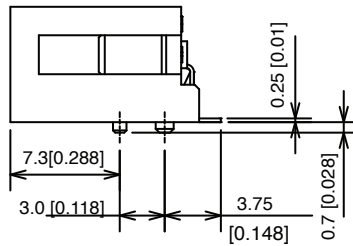

Pins	A	B	C	D	E
3	13.8 [0.54]	5.75 [.23]	4.65 [0.18]	11.6 [0.46]	4.00 [0.157]
4	15.8 [0.62]	6.75 [0.27]	5.65 [0.22]	13.6 [0.54]	6.00 [0.236]

mm [inch]			
Tolerance Unless Noted			
	.0	.00	.000
mm	±.3	±.13	

[], () Dimensions for Reference Only

Ordering Information

Available Combinations

- 37203-1AE0-003 PL
- 37203-1BE0-003 PL
- 37203-12E0-003 PL
- 37204-1AE0-004 PL
- 37204-1BE0-004 PL
- 37204-12E0-004 PL

372XX-1XE0-00X PL (RIA E1 and C1 Apply)

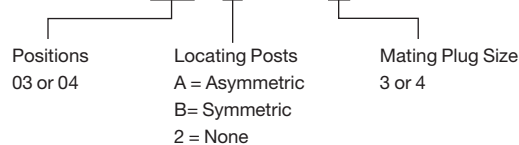

TS-2271-C
Sheet 2 of 4



Electronic Solutions Division
Interconnect Solutions
<http://www.3Mconnector.com>

3M is a trademark of 3M Company.
For technical, sales or ordering information call
800-225-5373

3M™ Mini-Clamp Socket

2 mm, Surfacement, Right Angle

372 Series

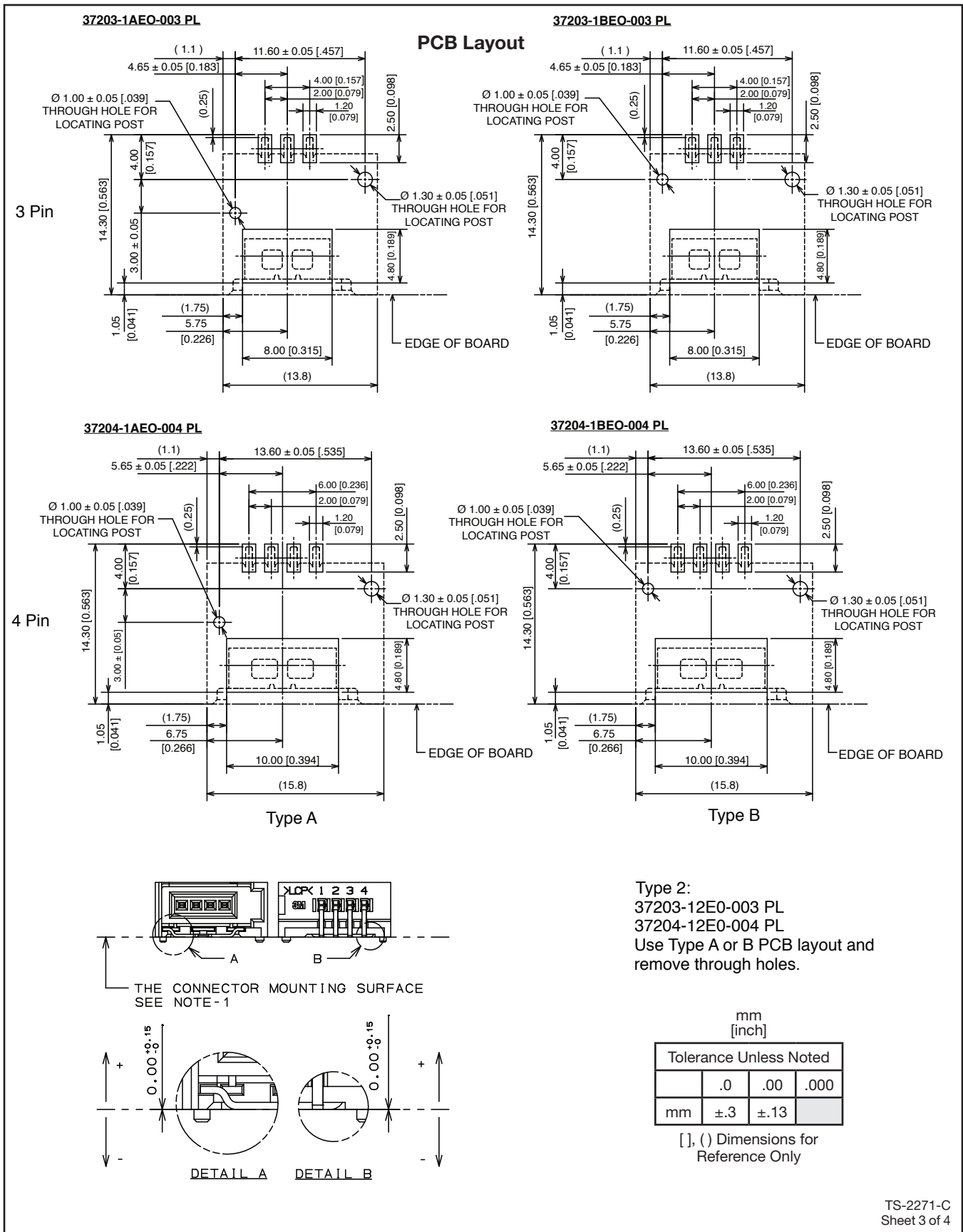

TS-2271-C
 Sheet 3 of 4

3M™ Mini-Clamp Socket

2 mm, Surfacement, Right Angle

372 Series

Tape and Reel Packaging

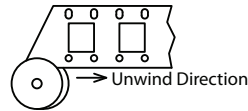
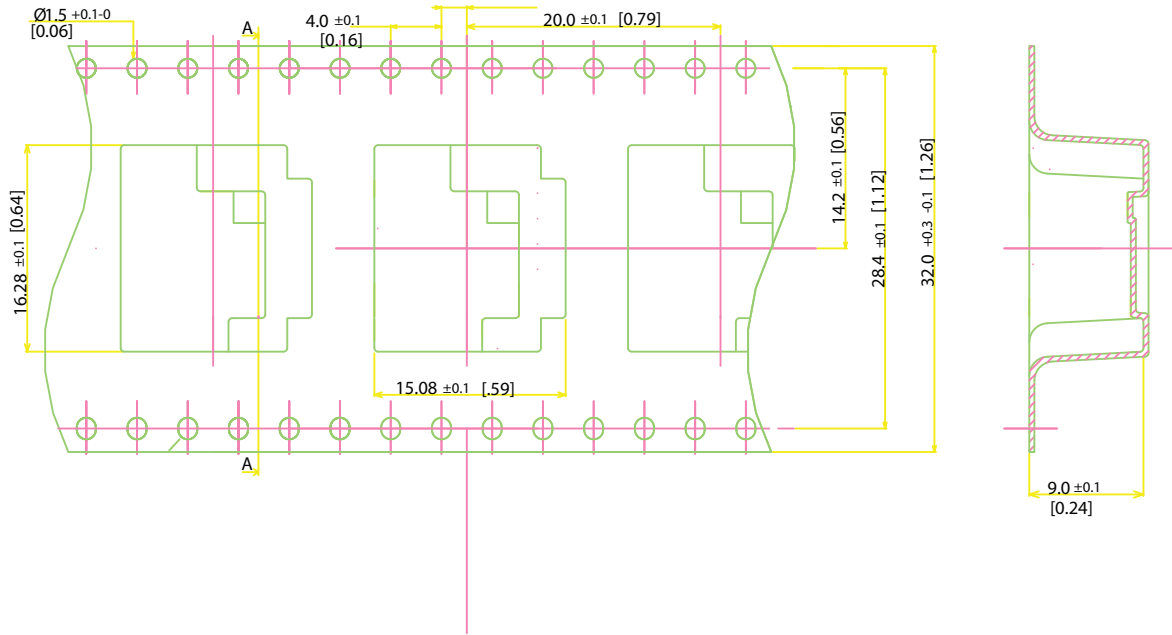

Accessories

Dust Cover Accessory



Ordering Information:

3 pos - 37803-1000-00

4 pos - 37804-1000-00

TS-2271-C
Sheet 4 of 4

X-ON Electronics

Largest Supplier of Electrical and Electronic Components

Click to view similar products for [Headers & Wire Housings](#) category:

Click to view products by [3M](#) manufacturer:

Other Similar products are found below :

[892-18-020-10-001101](#) [58102-G61-06LF](#) [582553-1](#) [0009485154](#) [009176003701906](#) [0050291907](#) [LY20-4P-DT1-P1E-BR](#) [02.125.8002.8](#)
[609-3404](#) [61062-3](#) [622-0430](#) [622-3653LF](#) [63453-116](#) [636-1030](#) [636-1427](#) [636-3427](#) [636-4007](#) [641938-9](#) [641991-4](#) [644827-2](#) [65817-010LF](#)
[65817-015LF](#) [65863-015LF](#) [66207-023LF](#) [67095-007LF](#) [67601157](#) [68648-049](#) [70.362.1628.0](#) [70-4210](#) [70-4226B](#) [70-4853B](#) [707-5020](#) [707-](#)
[5028](#) [71.350.2428.0](#) [71918-208LF](#) [71961-016LF](#) [733-134](#) [733-162](#) [754199-000](#) [760-3052](#) [787-8014-00](#) [79531-3000](#) [FCN-360C032-B](#) [FCN-](#)
[367T-T012/H](#) [FCN-723D010/2](#) [80.063.4001.1](#) [800-90-001-10-001000](#) [800-90-010-10-002000](#) [801-43-002-10-013000](#) [801-43-006-10-002000](#)